

User manual
Manuel d'utilisation
Manual del usuario
Benutzerhandücher
Gebruikershandleidingen
Manuale per l'utente
Användarhandböckerna
Brugermanual



PHILIPS

Important notes for users in the U.K.

Mains plug

This apparatus is fitted with an approved 13 Amp plug. To change a fuse in this type of plug proceed as follows:

- 1 Remove fuse cover and fuse.
- 2 Fix new fuse which should be a BS1362 3 Amp, A.S.T.A. or BSI approved type.
- 3 Refit the fuse cover.

If the fitted plug is not suitable for your socket outlets, it should be cut off and an appropriate plug fitted in its place.

If the mains plug contains a fuse, this should have a value of 3 Amp. If a plug without a fuse is used, the fuse at the distribution board should not be greater than 3 Amp.

Note: The severed plug must be disposed of to avoid a possible shock hazard should it be inserted into a 13 Amp socket elsewhere.

How to connect a plug

The wires in the mains lead are coloured with the following code: blue = neutral (N), brown = live (L).

- As these colours may not correspond with the colour markings identifying the terminals in your plug, proceed as follows:
 - Connect the blue wire to the terminal marked N or coloured black.
 - Connect the brown wire to the terminal marked L or coloured red.
 - Do not connect either wire to the earth terminal in the plug, marked E (or $\frac{1}{2}$) or coloured green (or green and yellow).

Before replacing the plug cover, make certain that the cord grip is clamped over the sheath of the lead - not simply over the two wires.

Copyright in the U.K.

Recording and playback of material may require consent. See Copyright Act 1956 and The Performer's Protection Acts 1958 to 1972.

Italia

DICHIARAZIONE DI CONFORMITA'

Si dichiara che l'apparecchio MCD988 Philips risponde alle prescrizioni dell'art. 2 comma 1 del D.M. 28 Agosto 1995 n. 548.

Fatto a Eindhoven

Philips Consumer Electronics
Philips, Glaslaan 2
5616 JB Eindhoven, The Netherlands

Norge

Typeskilt finnes på apparatens underside.

Observer: Nettbryteren er sekundert innkoplet. Den innebygde nettdelen er derfor ikke frakoplet nettet så lenge apparatet er tilsluttet nettkontakten.

For å redusere faren for brann eller elektrisk støt, skal apparatet ikke utsettes for regn eller fuktighet.

CAUTION

Use of controls or adjustments or performance of procedures other than herein may result in hazardous radiation exposure or other unsafe operation.

VAROITUS

Muiden kuin tässä esitettyjen toimintojen säädön tai asetusten muutto saattaa altistaa vaaralliselle säteilylle tai muille vaarallisille toiminnoille.

HDMI

HDMI (High Definition Multimedia Interface) is a digital interface that allows pure HD digital video transmission without the loss of image quality.

The integrated control bus allows system control between the TV set and connected devices like a digital set top box.

DOLBY VIRTUAL SPEAKER

DVS (Dolby Virtual Speaker) technology creates a highly compelling 5.1-channel listening experience from as few as two speakers, making it an ideal entertainment solution for locations where space for multiple speaker setup is limited.

This product incorporates copyright protection technology that is protected by method claims of certain U.S. patents and other intellectual property rights owned by Macrovision Corporation and other rights owners. Use of this copyright protection technology must be authorized by Macrovision Corporation, and is intended for home and other limited viewing uses only unless otherwise authorized by Macrovision Corporation. Reserve engineering or disassembly is prohibited.

DivX, DivX Certified, and associated logos are trademarks of DivXNetworks, Inc and are used under license.



Windows Media is a trademark of Microsoft Corporation.

Manufactured under license from Dolby Laboratories.

"Dolby", "Pro Logic" and the double-D symbol are trademarks of Dolby Laboratories.

DK

Advarsel: Usynlig laserstråling ved åbning når sikkerhedsafbrydere er ude af funktion. Undgå udsættelse for stråling.

Bemærk: Netafbryderen er sekundært indkoblet og afbryder ikke strømmen fra nettet. Den indbyggede netdel er derfor tilsluttet til lysnettet så længe netstikket sidder i stikkontakten.

S

Klass 1 laserparat

Varning! Om apparaten används på annat sätt än i denna bruksanvisning specificerats, kan användaren utsättas för osynlig laserstråling, som överskrider gränsen för laserklass 1.

Observera! Stömbrytaren är sekundärt kopplad och bryter inte strömmen från nätet. Den inbyggda nätdelen är därför ansluten till elnätet så länge stickproppen sitter i vägguttaget.

SF

Luokan 1 laserlaite

Varoitus! Laitteen käyttäminen muulla kuin tässä käyttöohjeessa mainitulla tavalla saattaa altistaa käyttäjän turvallisuusluokan 1 ylittävälle näkymättömälle lasersäteilylle.

Oikeus muutoksiin varataan. Laite ei saa olla alttiina tippu- ja roiskevedelle.

Huom. Toiminnanvalitsin on kytketty toisipuolelle, eikä se kytke laitetta irti sähköverkosta. Sisäänrakennettu verkko-osa on kytkettynä sähköverkkoon aina silloin, kun pistoke on pistorasiasassa.

DEMO MODE

To turn ON

Press

STOP ■

button

To turn OFF

Press

STOP ■

button again

Index

English 7

Français 46

Español 85

Deutsch 124

Nederlands 163

Italiano 202

Svenska 241

Dansk 280

English

Français

Español

Deutsch

Nederlands

Italiano

Svenska

Dansk

Language Code

Abkhazian	6566	Inupiaq	7375	Pushto	8083
Afar	6565	Irish	7165	Russian	8285
Afrikaans	6570	Íslenska	7383	Quechua	8185
Amharic	6577	Italiano	7384	Raeto-Romance	8277
Arabic	6582	Ivrit	7269	Romanian	8279
Armenian	7289	Japanese	7465	Rundi	8278
Assamese	6583	Javanese	7486	Samoan	8377
Avestan	6569	Kalaallisut	7576	Sango	8371
Aymara	6589	Kannada	7578	Sanskrit	8365
Azerbaijani	6590	Kashmiri	7583	Sardinian	8367
Bahasa Melayu	7783	Kazakh	7575	Serbian	8382
Bashkir	6665	Kernewek	7587	Shona	8378
Belarusian	6669	Khmer	7577	Shqip	8381
Bengali	6678	Kinyarwanda	8287	Sindhi	8368
Bihari	6672	Kirghiz	7589	Sinhalese	8373
Bislama	6673	Komi	7586	Slovensky	8373
Bokmål, Norwegian	7866	Korean	7579	Slovenian	8376
Bosanski	6683	Kuanyama; Kwanyama	7574	Somali	8379
Brezhoneg	6682	Kurdish	7585	Sotho; Southern	8384
Bulgarian	6671	Lao	7679	South Ndebele	7882
Burmese	7789	Latina	7665	Sundanese	8385
Castellano, Español	6983	Latvian	7686	Suomi	7073
Catalán	6765	Letzeburgesch;	7666	Swahili	8387
Chamorro	6772	Limburgan; Limburger	7673	Swati	8383
Chechen	6769	Lingala	7678	Svenska	8386
Chewa; Chichewa; Nyanja	7889	Lithuanian	7684	Tagalog	8476
中文	9072	Luxembourgish;	7666	Tahitian	8489
Chuang; Zhuang	9065	Macedonian	7775	Tajik	8471
Church Slav; Slavonic	6785	Malagasy	7771	Tamil	8465
Chuvash	6786	Magyar	7285	Tatar	8484
Corsican	6779	Malayalam	7776	Telugu	8469
Česky	6783	Maltese	7784	Thai	8472
Dansk	6865	Manx	7186	Tibetan	6679
Deutsch	6869	Maori	7773	Tigrinya	8473
Dzongkha	6890	Marathi	7782	Tonga (Tonga Islands)	8479
English	6978	Marshallese	7772	Tsonga	8483
Esperanto	6979	Moldavian	7779	Tswana	8478
Estonian	6984	Mongolian	7778	Türkçe	8482
Euskara	6985	Nauru	7865	Turkmen	8475
Ελληνικά	6976	Navaho; Navajo	7886	Twi	8487
Faroese	7079	Ndebele, North	7868	Uighur	8571
Français	7082	Ndebele, South	7882	Ukrainian	8575
Frysk	7089	Ndonga	7871	Urdu	8582
Fijian	7074	Nederlands	7876	Uzbek	8590
Gaelic; Scottish Gaelic	7168	Nepali	7869	Vietnamese	8673
Gallegan	7176	Norsk	7879	Volapuk	8679
Georgian	7565	Northern Sami	8369	Walloon	8765
Gikuyu; Kikuyu	7573	North Ndebele	7868	Welsh	6789
Guarani	7178	Norwegian Nynorsk;	7878	Wolof	8779
Gujarati	7185	Occitan; Provençal	7967	Xhosa	8872
Hausa	7265	Old Bulgarian; Old Slavonic	6785	Yiddish	8973
Herero	7290	Oriya	7982	Yoruba	8979
Hindi	7273	Oromo	7977	Zulu	9085
Hiri Motu	7279	Ossetian; Ossetic	7983		
Hrvatski	6779	Pali	8073		
Ido	7379	Panjabi	8065		
Interlingua (International)	7365	Persian	7065		
Interlingue	7365	Polski	8076		
Inuktitut	7385	Português	8084		

General Information

Features	9
Supplied accessories	9
Environmental information	9
Installation	9~10
Maintenance	10

Connections

Step 1: Connecting the subwoofer	11
Step 2: Placing the speakers	11
Step 3: Connecting speakers	12
Step 4: Connecting a USB device or a memory card	12
Step 5: Connecting TV	12
Using SCART jack	12
Using AV OUT jack	13
Using Component Video jacks (Y Pb Pr)	13
Using S-Video jack	14
Step 6: Connecting FM antenna	14
Step 7: Connecting the power cord	15
Additional: Connecting additional equipment	15

Functional Overview

DVD player and power amplifier	17
Remote control	18

Getting Started

Step 1: Inserting batteries into the Remote Control	20
Using the Remote Control to operate the Player	20
Step 2: Setting up the TV	20
Selecting the colour system that corresponds to your TV	20
Setting up Progressive Scan feature (for Progressive Scan TV only)	21
To deactivate Progressive manually	21
Step 3: Setting language preference	22
Setting the OSD Language	22
Setting the Audio, Subtitle and Disc Menu language	22

Basic Operations

Switching the system on/off	23
Switching the system to Eco Power Standby mode	23
Power-saving automatic standby	23
Volume control	23
Sound control	23
DBB	23
DSC (Digital Sound Control)	23
LOUDNESS	23
MOVING SURROUND	23
Dimming the display screen	24
Demonstration mode	24

Disc Operations

Playable Discs	25
Region Codes	25
Playing discs	25
Using the Disc Menu	26
Basic playback controls	26
Pausing playback	26
Selecting a track/chapter/title	26
Resuming playback from the last stopped point	26
Zoom	26
Repeat	26
Repeat A-B	27
Program	27
Forward/Reverse Searching	27
Time search & search by chapter/track number	27
Information display during playback	27
Special disc features	28
Playing a Title	28
Changing the Audio Language	28
Changing the Audio Channel	28
Subtitles	28
Playing MP3/WMA/JPEG Picture disc	28
Playing MP3/WMA disc	28
General operation	28
Playback selection	28
Playing JPEG Picture CD	29
General operation	29
Playback selection	29
Special JPEG features	29
Preview function	29
Zoom picture	29
Playback with multi-angles	29
Playing a DivX disc	30

System Menu Options

Basic operations	31
General Setup Page	31
TV Display	31
OSD Language	31
Screen Saver	31
DIVX VOD	32
Audio Setup Page	32
ANALOG AUDIO SETUP	32
DIGITAL AUDIO SETUP	32
Dolby Digital Setup	33
3D	33
HDCD	33
Night Mode	33
Video Setup Page	33
Component	34
TV Mode	34
PICTURE SETTING	34
HDMI SETUP	34
Preference Page	35
Parental	35
Default	35
Password Setup	36

Other Functions

Radio Reception	37
Tuning to radio stations	37
Presetting radio stations	37
Listening to preset radio stations	37
RDS	37
Setting the RDS clock	37
Setting the clock	38
Setting sleep/wake-up timer	38
Sleep timer setting	38
Wake-up timer setting	38

External Sources

Using a non-USB device	39
Using a USB mass storage device	39~40

Specifications

Troubleshooting

Glossary

Disposal of your old product

Your product is designed and manufactured with high quality materials and components, which can be recycled and reused.



When this crossed-out wheeled bin symbol is attached to a product it means the product is covered by the European Directive 2002/96/EC

Please inform yourself about the local separate collection system for electrical and electronic products.

Please act according to your local rules and do not dispose of your old products with your normal household waste. The correct disposal of your old product will help prevent potential negative consequences for the environment and human health.

Features

Your DVD Micro Theatre with 2.1 channel full digital amplifier creates the same dynamic sound qualities that you find in full-fledged cinemas and incorporates some of the best features in home theater technology.

Other features include:

Built-in Dolby Digital decoder; supporting DSC sound setting.

Additional Component Connections

Lets you connect other audio and audio/visual components to the DVD micro theatre.

Night mode

Lets you compress the dynamic range, reducing the difference in loudness between different sounds in Dolby Digital mode.

Parental Control (Rating Level)

Lets you set a ratings level so that your children cannot watch a DVD that has a rating higher than you set.

Sleep/Wake-up Timer

Enables the system to switch on/off automatically at a preset time.

Progressive Scan

Provides high quality flicker-free images for film based sources. When a picture refreshes, its vertical resolution can double to 525 lines.

Note:

– *To fully enjoy the progressive scan feature, you need a progressive scan TV.*

Supplied accessories

- Remote control with two AAA batteries
- FM wire antenna
- DIN cable to connect the subwoofer and the main unit
- AV cord (R/W/Y)
- 2 front speakers including 2 speaker cables
- This instruction booklet and a Quick Start Guide
- SCART adapter
- Cabling channel (optional)
- Brackets and screws for wall mounting

If any item is damaged or missing, contact your retailer or Philips.

Environmental information

All unnecessary packaging has been omitted. We have tried to make the packaging easy to separate into three materials: cardboard (box), polystyrene foam (buffer) and polyethylene (bags, protective foam sheet).

Your system consists of materials which can be recycled and reused if disassembled by a specialised company. Please observe the local regulations regarding the disposal of packaging materials, exhausted batteries and old equipment.

Installation

- Place the player on a flat, hard, and stable surface.
- In a cabinet, allow about 10cm (4 inches) of free space all around the player for adequate ventilation.

General Information

- Do not expose your player to extreme temperatures or humidity.
- The apparatus shall not be exposed to dripping or splashing.
- No objects filled with liquids, such as vases, shall be placed on the apparatus.
- No naked flame sources, such as lighted candles, shall be placed on the apparatus.
- Install this unit near the AC outlet and where the AC power plug can be reached easily.
- The ventilation should not be impeded by covering the ventilation openings with items, such as newspapers, table-cloths, curtains, et.

Maintenance

- When a disc becomes dirty, clean it with a cleaning cloth. Wipe the disc from the center out, in a straight line.
- Do not expose the player, batteries or discs to humidity, rain, sand or excessive heat (caused by heating equipment or direct sunlight). Always keep the disc tray closed to avoid dust on the lens.
- Do not use solvents such as benzene, thinner, commercially available cleaners, or anti-static spray intended for colour discs.
- The lens may cloud over when the player is suddenly moved from cold to warm surroundings, making it impossible to play a disc. Leave the player in the warm environment until the moisture evaporates.



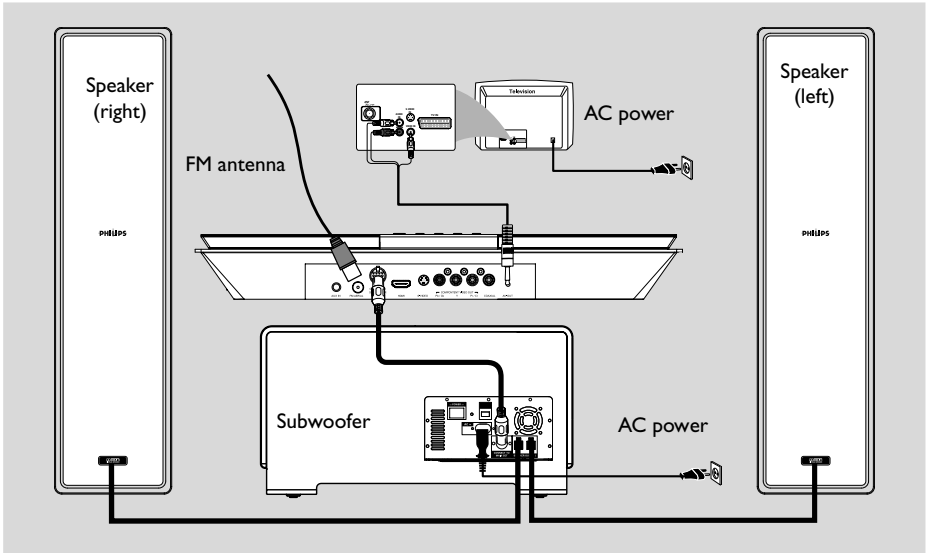

IMPORTANT!

- The type plate is located at the bottom of the system.
- Before connecting the AC power cord to the wall outlet, ensure that all other connections have been made.
- Never make or change any connections with the power on.
- To connect a cable to the corresponding jack on the rear panel, make sure to lead it through the square hole of the stand.
- A separate power switch is provided on the back of the subwoofer. Please switch it on after completing all connections in order to enjoy 2.1-channel sound output.

- Connect the subwoofer to the main unit with the supplied system cable (grey).

Step 2: Placing the speakers

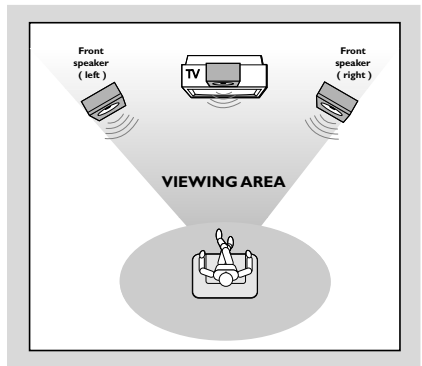

Step 1: Connecting the subwoofer

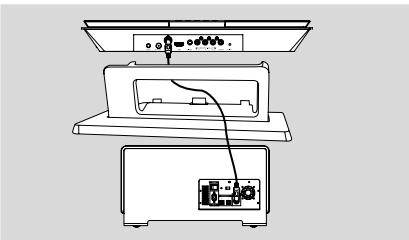

- Place the front left and right speakers at equal distances from the TV set and at an angle of approximately 45 degrees from the listening position.

Notes:

- To avoid magnetic interference, do not position the front speakers too close to your TV set.
- Allow adequate ventilation around the DVD System.

Step 3: Connecting speakers

- Install the speakers to the corresponding stand with screws.
- Connect the left and right speakers to the SPEAKERS (4Ω) terminals on the back of the subwoofer with the supplied speaker cables. Right speaker to "R" and left speaker to "L". Fully insert the speaker wire into the terminal.

Notes:

- Ensure that the speaker cables are correctly connected. Improper connections may damage the system due to short-circuit.
- For optimal sound performance, use the supplied speakers.
- Do not connect more than one speaker to any one pair of +/- speaker jacks.
- Do not connect speakers with an impedance lower than the speakers supplied. Please refer to the SPECIFICATIONS section of this manual.
- To install the speakers on the wall, please see the Appendix for wall mounting instructions.

Step 4: Connecting a USB device or a memory card

- By connecting a USB mass storage device (including USB flash memory, USB flash players or memory cards) to the Hi-Fi system, you can enjoy the device's stored music through the powerful speakers of Hi-Fi system.



Insert the USB device's USB plug into the  socket on the set.

OR

for the devices with USB cables:

- 1 Insert one plug of the USB cable (not supplied) to the  socket on the set.
- 2 Insert the other plug of the USB cable to the USB output terminal of the USB device.

OR

for the memory card:

- 1 Insert the memory card into a card reader (not supplied).
- 2 Use a USB cable (not supplied) to connect the card reader into the  socket on the set.

Step 5: Connecting TV

IMPORTANT!

- You only need to make one video connection from the following options, depending on the capabilities of your TV.
- Connect the DVD system directly to the TV.
- A SCART connection allows you to use both Audio and Video features on the system.

Using SCART jack

- Connect the video and audio connectors of the supplied AV cable to the corresponding jacks on the SCART adapter; and then plug the adapter to the SCART jack of the TV.

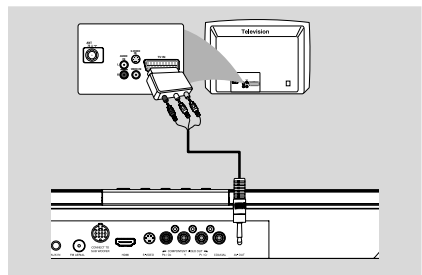

Using AV OUT jack

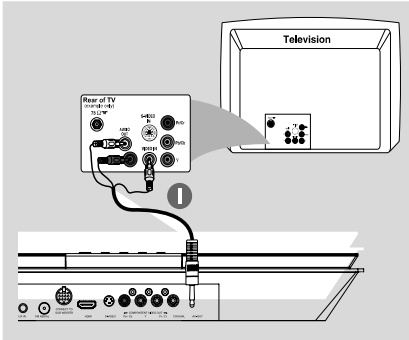

- 1 Connect the end of the supplied AV cord with only one connector to the **AV OUT** jack of the DVD system.
- 2 For the other end, connect the video output connector (yellow) to the video input jack (or labeled as A/V In, CVBS, Composite or Baseband) on the TV. To hear the sound of this DVD system through your TV, connect the audio connectors (white/ red) to the audio input jacks on the TV.

Using Component Video jacks (Y Pb Pr)

IMPORTANT!

– The progressive scan video quality is only possible when using Y Pb Pr, and a progressive scan TV is required.

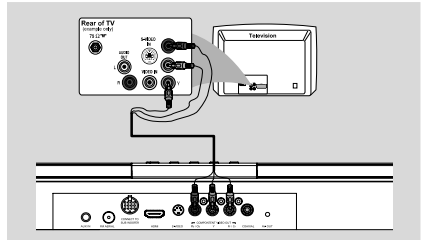

- 1 Use component video cables (red/blue/green - not supplied) to connect the DVD system's **COMPONENT (Pr/Cr Pb/CbY)** jacks to the corresponding Component video input jacks (or labeled as Y Pb/Cb Pr/Cr or YUV) on the TV.
- 2 To hear the TV channels through this DVD system, use the audio cables (white/red-not supplied) to connect **AUX IN** jacks to the corresponding AUDIO OUT jacks on the TV.
- 3 If you are using a Progressive Scan TV (TV must indicate Progressive Scan or ProScan capability), to activate TV Progressive Scan, please refer to your TV user manual. For DVD system Progressive Scan function, see "Getting Started-Setting up Progressive Scan feature".

Note:

- If your TV does not support Progressive Scan, you will not be able to view the picture.
- Press **SYSTEM** on the remote to exit the system menu, and then press **DISC 1** (or **DISC 2**) and **"1"** to exit progressive scan.

Connections

Using S-Video jack

IMPORTANT!

– If **S-Video** is used for DVD playback connection, the system's **VIDEO OUT** setting will need to be changed accordingly.

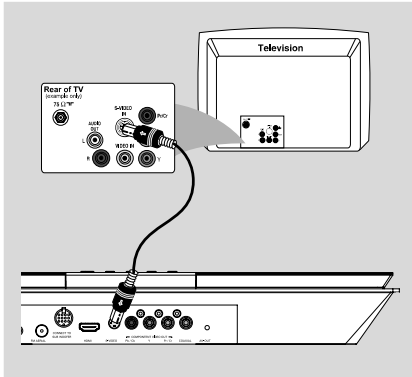

- 1 Use an S-Video cable (not supplied) to connect the DVD system's **S-VIDEO** jack to the S-Video input jack (or labeled as Y/C or S-VHS) on the TV.
- 2 To hear the TV channels through this DVD system, use the audio cables (white/red-not supplied) to connect **AUX IN** jacks to the corresponding **AUDIO OUT** jacks on the TV.

Step 6: Connecting FM antenna

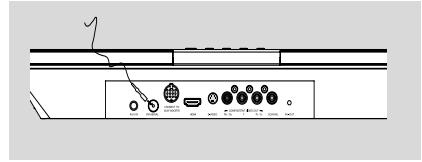

Connect the supplied FM antenna to the FM (75 Ω) jack. Extend the FM antenna and fix its end to the wall.

For better FM stereo reception, connect an external FM antenna (not supplied).

Note:

- Adjust the position of the antennas for optimal reception.
- Position the antennas as far as possible from your TV, VCR or other radiation source to prevent unwanted interference.

Step 7: Connecting the power cord

After everything is connected properly, plug in the AC power cord to the power outlet.

Switch on the power on the back of the subwoofer.

Never make or change any connection with the power on.

Additional: Connecting additional equipment

IMPORTANT!

- Some discs are copy-protected. You cannot record the disc through a VCR or digital recording device.
- When making connections, make sure the colour of cables matches the colour of jacks.
- Always refer to the owner's manual of the other equipment for complete connection and usage details.

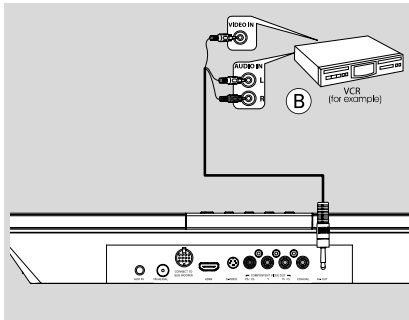

Viewing and listening to the playback of other equipment (A)

- Connect the system's **AUX IN** jacks to the AUDIO OUT jacks on the other audio/visual device (such as a TV, VCR, Laser Disc player or cassette deck).
Before starting operation, press **SOURCE** on the front panel to select AUX or press **AUX** on the remote in order to activate the input source.

Using the VCR for recording DVDs (B)

- Connect one of the system's **VIDEO** jack to the corresponding VIDEO IN jack and **AUDIO OUT L/R** jacks to the AUDIO IN jacks on the VCR. This will allow you to make analogue stereo (two channel, right and left) recordings.

Recording (digital) (C)

- Connect the system's **COAXIAL** jack to the DIGITAL IN jack on a digital recording device. Before starting operation, set the DIGITAL OUT according to the audio connection. (See "DIGITAL OUT".)

Connections

Connecting to a TV with HDMI Jack

HDMI connects untouched and uncompressed digital transmission for the highest and crispest sound/image quality.

It has plug and play capability using only one cable for both audio/video output.

- Use a HDMI cable (not supplied) to connect the **HDMI** jack on the DVD Player to **HDMI IN** on a HDMI compatible device (e.g; TV, Projector, Adaptor).
 - It may take a while for the DVD player and input device to communicate and initialise.
 - Playback starts automatically.

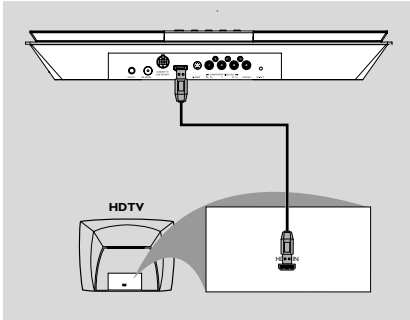

Notes:

- Proceed to "Setup Menu Options" → "VIDEO SETUP PAGE" → "HDMI SETUP" for detailed HDMI setup.
- If you are using the HDMI as audio source, make sure that "DIGITAL OUTPUT" is set to "PCM only" (see "Setup Menu Options" → "AUDIO SETUP PAGE" → "DIGITAL AUDIO SETUP").
- To stop sound output from your TV after making the HDMI connection, make sure that "DIGITAL OUTPUT" is set to "SPDIF OFF" (see "Setup Menu Options" → "AUDIO SETUP PAGE" → "DIGITAL AUDIO SETUP").

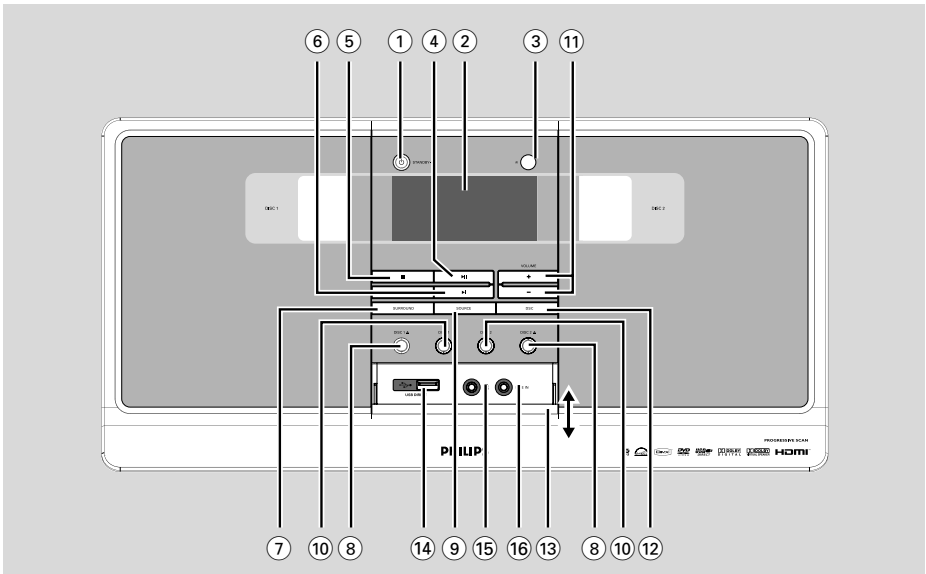

DVD player and power amplifier

- ① **ECO POWER/STANDBY-ON** \downarrow
 - switches on the system or puts it on to Eco power/normal standby mode.
- ② **Display**
 - shows the current status of the DVD player.
- ③ **IR SENSOR**
 - points the remote control towards this sensor.
- ④ **▶ ||**
 - starts or interrupts disc playback.
- ⑤ **STOP ■**
 - stops disc playback or erases a program.
 - in Demo mode (*on the system only*), activates/deactivates the demonstration.
- ⑥ **◀ / ▶**

Disc:

 - skips to the previous/next chapter/title/track.

Tuner:

 - tunes to a higher/lower radio frequency.
 - press and hold, then release the key to start automatic search for a radio frequency downward/upward.
- ⑦ **MOVING SURROUND**
 - enables / disables the surround sound effect with moving speakers

- ⑧ **DISC 1 OPEN-CLOSE ▲ / DISC 2 OPEN-CLOSE ▲**
 - opens or closes the disc tray.
- ⑨ **SOURCE**
 - selects the respective sound source: DVD/AUX/TUNER (FM)/USB.
 - switches the system on.
- ⑩ **DISC 1 / DISC 2**
 - selects and plays disc 1 or disc 2.
- ⑪ **VOLUME - / +**
 - adjusts the volume upward/downward.
 - adjusts the hours and minutes in clock/timer setting mode
 - switches the set timer ON or OFF.
- ⑫ **DSC**
 - selects different types of preset sound equalizer settings
 - For CD: CLASSIC, POP, JAZZ, ROCK;
 - For DVD: CONCERT, SCI-FI, DRAMA, ACTION.
- ⑬ **SLIDE OPEN**
 - slides down to open the covering plate for USB, LINE IN and headphone jacks.
- ⑭ **USB DIRECT**
 - the jack for the external USB mass storage device.

Functional Overview

- 15
 - connects headphones
- 16 **LINE IN**
 - connects an external non-USB device.

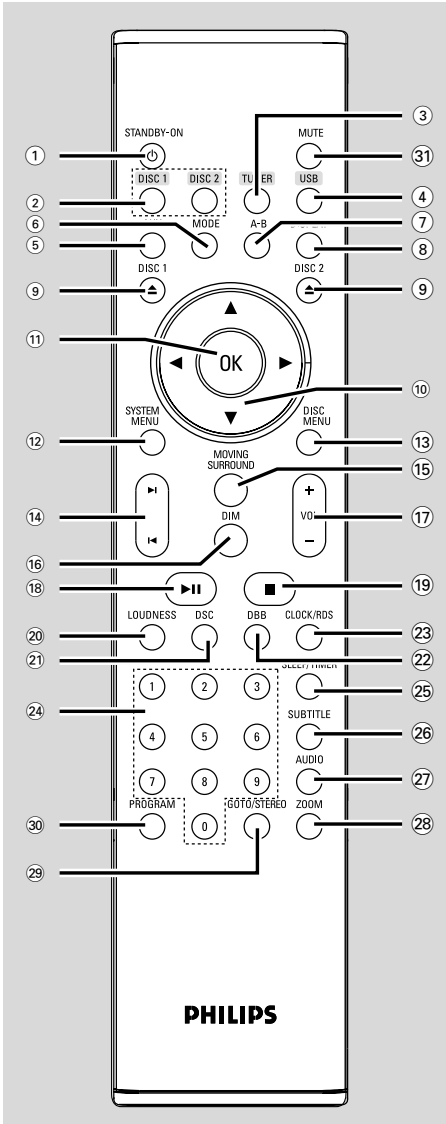

Remote control

- 1
 - switches on the system or puts it on to the Eco power/normal standby mode.
- 2 **DISC 1 / DISC 2**
 - selects and plays disc 1 or disc 2.
- 3 **TUNER**
 - selects the tuner source.
- 4 **USB**
 - selects to play from a USB message storage device.
- 5 **AUX**
 - selects the AUX source.
- 6 **MODE**
 - selects various repeat modes or the shuffle play mode for a disc.
- 7 **A-B**
 - repeats playback of a specific section on a disc.
- 8 **DISPLAY**
 - displays information on TV screen during playback
- 9 **DISC 1 ▲ / DISC 2 ▲**
 - opens or closes the disc compartment
- 10
 - selects an item in a menu.
 - moves an enlarged picture up/down/left/right.
 - / searches backward/forward in a disc at different speeds.
- 11 **OK**
 - confirms a selection
- 12 **SYSTEM MENU (disc mode only)**
 - enters or exits the system menu.
- 13 **DISC MENU (disc mode only)**
 - DVD/VCD: enters or exits the disc contents menu.
 - VCD2.0: switches the playback control mode on or off.
 - MP3/WMA: switches between Album and Filelist.
- 14
 - Disc: skips to the previous/next chapter/title/track
 - Tuner: selects a preset radio station.

15 MOVING SURROUND

- enables / disables the surround sound effect with moving speakers

16 DIM

- selects different levels of brightness for the display screen.

17 VOL +/-

- adjusts the volume upward/downward.
- adjusts the hours and minutes in clock/timer setting mode.
- switches the set timer ON or OFF.

18 ► II

- starts or interrupts disc playback.

19 ■

- stops disc playback or erases a program.

20 LOUDNESS

- enables or disables automatic loudness adjustment.

21 DSC

- selects different types of preset sound equalizer settings (CLASSIC, JAZZ, ROCK, POP or FLAT; for DVD: NORMAL, CONCERT, DRAMA, ACTION or SCI-FI).

22 DBB (Dynamic Bass Boost)

- enhances the bass.

23 CLOCK / RDS

Standby mode

- sets the system clock.

Playback mode

- displays the system clock.

Eco power mode

- displays the system clock and switches to the standby mode.

For tuner

- displays RDS information.

24 Numeric Keypad (0-9)

- inputs a track/title/chapter number of the disc.

25 SLEEP/TIMER

Standby mode

- sets time for switching on the system automatically.

Power-on mode

- sets the sleep timer function (auto off).

26 SUBTITLE

- selects a subtitle language.

27 AUDIO

for VCD/DivX

- sets Stereo, Mono-Left or Mono-Right sound mode.

for DVD

- selects an audio language.

28 ZOOM

- DVD/VCD/Picture CD: enlarges or reduces a picture or active image on the TV screen.

29 GOTO / STEREO

- in the DISC mode, fast searches in a disc by entering a time, title, chapter or track.
- FM: sets the stereo or mono sound mode.

30 PROGRAM

- DVD/VCD/CD: enters the program menu.
- MP3/WMA-CD: adds/deletes a programmed track to/from the program list.
- Tuner: programs preset radio stations.

Notes for remote control:

- **First, select the source you wish to control by pressing one of the source select keys on the remote control (DISC or TUNER, for example).**
- **Then select the desired function (►II, ◀, ▶ for example).**

Getting Started

Step 1: Inserting batteries into the Remote Control

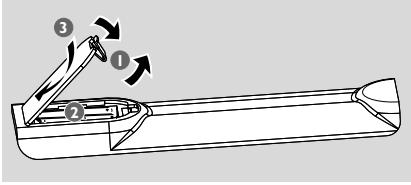

- 1 Open the battery compartment.
- 2 Insert two AAA batteries following the indications (+/-) inside the compartment.
- 3 Close the cover.

Using the Remote Control to operate the Player

- 1 Aim the Remote Control directly at the remote sensor (IR) on the front panel.
- 2 Do not put any objects between the Remote Control and the DVD Player while operating the DVD Player.

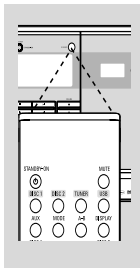

CAUTION!

- Remove batteries if they are exhausted or if the Remote Control is not being used for a long time.
- Do not use old and new or different types of batteries in combination.
- Batteries contain chemical substances, so they should be disposed of properly.

Step 2: Setting up the TV

IMPORTANT!

Make sure you have completed all the necessary connections. (See "Connecting TV").

- 1 Switch the DVD system on and then select DISC source. (See "Switching the system on/off").

- 2 Turn on the TV and set to the correct video-in channel. You should see the blue Philips DVD background screen on the TV.
 - Usually these channels are between the lowest and highest channels and may be called FRONT, AV IN, or VIDEO. See your TV manual for more details.
 - Or, you may go to channel 1 on your TV, then press the Channel down button repeatedly until you see the Video In channel.
 - Or, the TV Remote Control may have a button or switch that chooses different video modes.
 - Or, set the TV to channel 3 or 4 if you are using an RF modulator.

Selecting the colour system that corresponds to your TV

This DVD Player is compatible with both NTSC and PAL. In order for a DVD disc to play on this Player, the colour system of the Disc, the TV and the DVD Player should match.

- 1 Press **SYSTEM MENU** in full stop mode.
- 2 Press ◀▶ to select "PREFERENCE PAGE".
- 3 Use ◀▶ ▲ ▼ on the remote to navigate in the menu.

Move to "TV TYPE" and press ▶.

- **PAL**: Select this if the connected TV is PAL system. It will change the video signal of a NTSC disc and output in PAL format.
- **Multi**: Select this if the connected TV is compatible with both NTSC and PAL (multi-system). The output format will be in accordance with the video signal of the disc.
- **NTSC**: Select this if the connected TV is NTSC system. It will change the video signal of a PAL disc and output in NTSC format.

- 4 Select an item and press **OK**.

Notes:

- This option is available only when the "HDMI" is set to "OFF".

– Before changing the current TV Type setting, ensure that your TV supports the selected TV Type.



Setting up Progressive Scan feature (for Progressive Scan TV only)

The progressive scan display twice the number of frames per seconds than interlaced scanning (ordinary normal TV system). With nearly double the number of lines, progressive scan offers higher picture resolution and quality.

IMPORTANT!

Before enabling the progressive scan feature, you must ensure:

- 1) Your TV can accept progressive signals, a progressive scan TV is required.
- 2) You have connected the DVD player to your TV using Y Pb Pr (see "Connections-Step 5: Connecting TV- Using Component Video jacks".)

- 1 Turn on your TV.
- 2 Turn off your TV progressive scan mode or turn on interlaced mode (refer to your TV user manual).
- 3 Press **ECO POWER/STANDBY-ON**  (on the remote) to turn on the DVD player.
- 4 Select the correct Video Input channel.
→ The DVD background screen appears on the TV.
- 5 Press **SYSTEM MENU**.
- 6 Press   repeatedly to select "VIDEO SETUP PAGE".
- 7 Select "TV MODE" to "P-SCAN", then **OK** to confirm.
→ The instruction menu appears on the TV.

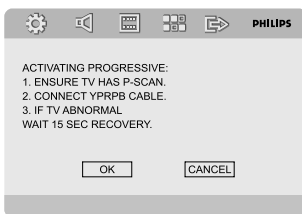



- 8 Press   to highlight "OK" in the menu and press **OK** to confirm.

There will be a distorted picture on your TV at this state until you turn on the progressive scan mode on your TV.

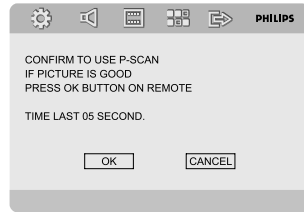
- 9 Turn on your TV progressive scan mode (refer to your TV user manual).
→ The following menu appears on the TV.



- 10 Press   to highlight "OK" in the menu and press **OK** to confirm.
→ The setup is complete now and you can start enjoy the high quality picture.

To deactivate Progressive manually

- **When the distorted sign still appears on the TV**, it may be due to the connected TV does not accept progressive signals, and progressive is set by mistake. You must reset the unit to interlace format.
- 1 Turn off your TV progressive scan mode or turn on to interlaced mode (refer to your TV user manual).
 - 2 Press **SYSTEM MENU** on the remote to exit the system menu and then **DISC 1** (or **DISC 2**) and "1" to exit progressive scan.
→ The DVD blue background screen will appear on the TV.

Note:

– During normal playback in the progressive scan mode, press **SYSTEM MENU** on the remote to exit the system menu, and then press **DISC 1** (or **DISC 2**) and "1" to exit progressive scan.

Getting Started

Step 3: Setting language preference

You can select your own preferred language settings. This DVD system will automatically switch to the selected language whenever you load a disc. If the language selected is not available on the disc, the disc's default language will be used instead. The OSD language in the system menu will remain once selected.

Setting the OSD Language

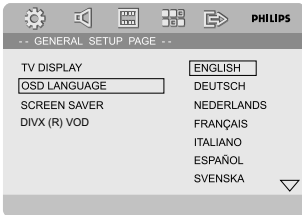

- 1 Press **SYSTEM MENU**.
- 2 Press ◀▶ to select "GENERAL SETUP PAGE".
- 3 Use ◀▶ ▲ ▼ on the remote to navigate in the menu.
Move to "OSD LANGUAGE" and press ▶.
- 4 Select a language and press **OK**.

To exit from the menu

- Press **SYSTEM MENU** again.

Setting the Audio, Subtitle and Disc Menu language

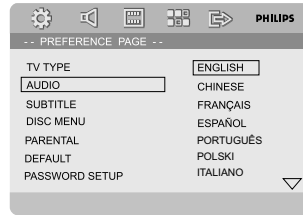

- 1 Press **SYSTEM MENU** in stop mode.
- 2 Press ◀▶ to select "PREFERENCE PAGE".
- 3 Press ▲ ▼ to highlight the following in the Preference Page.
 - "AUDIO" (disc's soundtrack)
 - "SUBTITLE" (disc's subtitles)
 - "DISC MENU" (disc's menu)
- 4 Enter its submenu by pressing ▶.
- 5 Select a language and press **OK**.
- 6 Repeat steps 3–5 for other language settings.

To exit from the menu

- Press **SYSTEM MENU** again.



Switching the system on/off

- Press **ECO POWER/STANDBY-ON**  (⏻) on the remote).
- Press **DISC, TUNER** or **AUX** on the remote.
→ The system will switch to the selected source.

To switch the system to standby mode

- Press **ECO POWER/STANDBY-ON**  (⏻) on the remote).

Switching the system to Eco Power Standby mode

- Press **ECO POWER/STANDBY-ON**  in active mode.
→ The system enters Eco power standby (the ECO POWER LED is on) or normal standby mode with clock display.
- The volume level (up to a maximum volume level of 12), interactive sound settings, last selected mode, source and tuner presets will be retained in the player's memory.
- If the system is in normal standby mode with clock display, press and hold **ECO POWER/STANDBY-ON**  for 3 seconds or more to switch to Eco power standby or vice versa.

Power-saving automatic standby

As a power-saving feature, the system will automatically switch to Standby mode if you do not press any buttons within 15 minutes after a disc has stopped playing.

Volume control

Turn **VOLUME (-/+)** clockwise or anticlockwise (or press **VOLUME +/-** on the remote) to increase or decrease the volume level.
→ "VOL xx" is displayed on the display panel.
"xx" denotes the volume level.

To switch off the volume temporarily

- Press **MUTE** on the remote.
→ Playback will continue without sound and "MUTING" flashes.

- To activate sound reproduction, you can:
 - press **MUTE** again;
 - adjust the volume controls;
 - change source.

Sound control

DBB

DBB enhances the bass response.

- Press **DBB** on the remote to enable/disable DBB feature.
→ Some discs might be recorded in high modulation, which causes a distortion at high volume. If this occurs, switch off DBB or reduce the volume.

DSC (Digital Sound Control)

DSC provides a different type of preset sound equalizer setting.

- Press **DSC** on the remote repeatedly to select: CLASSIC, JAZZ, ROCK, POP or FLAT (for DVD: NORMAL, CONCERT, DRAMA, ACTION or SCI-FI).

LOUDNESS

LOUDNESS feature enables the system to automatically increase the treble and bass sound effect at low volume (the higher the volume, the lower the treble and bass increase).

- Press **LOUDNESS** on the remote to enable or disable LOUDNESS feature.
→  icon appears/disappears after this feature is enabled/disabled.

MOVING SURROUND

DVS (Dolby Virtual Speaker) technology creates a highly compelling 5.1-channel listening experience from as few as two speakers, making it an ideal entertainment solution for locations where space for multiple speaker setup is limited. This feature enables you to switch between the surround sound mode and the ordinary music mode.

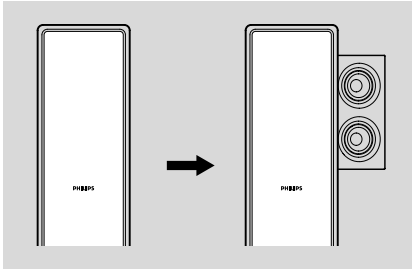

- Press **MOVING SURROUND** to switch between the surround sound mode and ordinary music mode.
 - When the surround sound mode is enabled, a "MOVING SURROUND" icon will appear on the display panel and the top parts of the left and right front speakers will swivel sideways to achieve the moving surround effect.
 - When the surround sound mode is disabled, the "MOVING SURROUND" icon will disappear from the display panel and the top parts of the left and right front speakers will return to their previous positions to resume the ordinary music mode.

Note:

– See "System Menu Options-AUDIO SETUP PAGE-ANALOG AUDIO SETUP" for more DVS setup options.

Dimming the display screen

- Press **DIM** repeatedly to select different levels of brightness for the display screen.

Demonstration mode

The system has a demonstration mode that shows the various features offered by the system.

To activate the demonstration

- In **standby mode**, press **STOP** ■ on the system to activate the demo mode.
 - Demonstration will begin.

To deactivate the demonstration

- Press **STOP** ■ on the system again.
 - "DEMO OFF" is displayed.

Note:

– *Even if you remove the AC power cord and reconnect it to the wall socket, the demonstration will remain off until you activate it again.*

IMPORTANT!

- Depending on the DVD or VIDEO CD, some operations may be different or restricted.
- Do not push on the disc tray or put any objects other than disc on the disc tray. Doing so may cause the disc player malfunction.
- If the inhibit icon (⊘) appears on the TV screen when a button is pressed, it means the function is not available on the current disc or at the current time.

Playable Discs

Your DVD Player will play:

- Digital Video Discs (DVDs)
- Video CDs (VCDs)
- Super Video CDs (SVCDs)
- Digital Video Discs + Rewritable (DVD+RW)
- Compact Discs (CDs)
- Picture (Kodak, JPEG) files on CDR(W)
- DivX(R) disc on CD-R(W):
- DivX 3.11, 4.x and 5.x
- WMA
- Supported MP3-CD format.
- ISO 9660
- Max. title/album name –12 characters
Max. title number plus album is 255.
- Max. nested directory is 8 levels.
- The max. album number is 32.
- The max. MP3 track number is 999.
- Supported sampling frequencies for MP3 disc: 32 kHz, 44.1 kHz, 48 kHz.
- Supported Bit-rates of MP3 disc are: 32, 64, 96, 128, 192, 256 (kbps).
- Following formats can't be supported
- The files like *.VMA, *.AAC, *.DLF, *.M3U, *.PLS, *.WAV
- Non-English Album/Title name
- The discs recorded under Joliet format
- MP3 Pro and MP3 with ID3 tag

Region Codes

DVDs must be labeled as shown below in order to play on this DVD system. You cannot play discs that are labeled for other regions.



Note:

- If you are having trouble playing a certain disc, remove the disc and try a different one. Improper formatted disc will not play on this DVD Player.

Playing discs

- 1 Connect the power cords of the system and TV (or any optional stereo or AV receiver) to a power outlet.
- 2 Turn on the TV power and set to the correct Video In channel. (See "Setting up the TV").
- 3 Press **ECO POWER/STANDBY-ON** on the DVD Player front panel or on the remote.
 - You should see the blue Philips DVD background screen on the TV.
- 4 Press **OPEN-CLOSE** to open the disc tray and load in a disc, then press the same button again to close the disc tray.
 - Make sure the label side is facing you.
- 5 Playback will start automatically (depending on the disc type).
 - If a disc menu appears on the TV, see "Using the Disc Menu".
 - If the disc is locked by parental control, you must enter your four-digit password. (See "PASSWORD SETUP PAGE").
- 6 At any time, simply press **STOP** to stop playback.

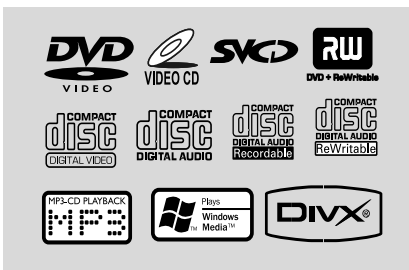

Disc Operations

Using the Disc Menu

Depending on the disc, a menu may appear on the TV screen once you load the disc.

To select a playback feature or item

- Use ◀ ▶ ▲ ▼ and **OK** or **Numeric Keypad (0-9)** on the remote.
→ Playback will start automatically.

To access or exit from the menu

- Press **DISC MENU** on the remote.

For VCD with Playback Control (PBC) feature (version 2.0 only)

PBC playback allows you to play Video CDs interactively, following the menu on the display.

- During playback, press **DISC MENU**.
→ If PBC was ON, it will switch to OFF and continue playback.
→ If PBC was OFF, it will switch to ON and return to menu screen.

Basic playback controls

Pausing playback (DVD/VCD/CD/MP3/DivX/WMA)

- 1 During playback, press ▶||. → Playback will pause and sound will be muted.
- 2 Press ▶|| again to resume.

Selecting a track/chapter/title (DVD/VCD/DivX/CD)

- 1 Press ▶ during playback to go to the next chapter/track
- 2 Press ◀ to go to the previous chapter/track.
- 3 To go directly to any chapter/track/title, enter the chapter/track/title number using the **Numeric Keypad (0-9)**.

Resuming playback from the last stopped point (DVD/VCD/CD)

- In stop mode and when a disc has not been removed, press ▶||.

To cancel resume mode

- In stop mode, press **STOP** ■ again.

Zoom (DVD/VCD/DivX/JPEG)

Zooming allows you to enlarge or reduce the video image during playback.

- 1 Press **ZOOM** repeatedly to enlarge or reduce the playback video image.
- 2 Press ◀ ▶ ▲ ▼ to pan across the TV screen.

Repeat (DVD/VCD/CD/MP3/DivX/WMA)

For DVD/VCD/CD

- Press **MODE** repeatedly to choose a repeat mode during playback.

Chapter (DVD)

– to repeat playback of the current chapter.

Track (CD/VCD)/Title (DVD)

– to repeat playback of the current track (CD/SVCD/VCD)/title (DVD).

All

– to repeat playback of all the disc.

Shuffle

– to repeat playback at random order.

For MP3/WMA/DivX

- Press **MODE** continuously to access different repeat modes.
→ **Shuffle**: play all files in the selected folder in random order.
→ **Repeat One**: play an MP3/WMA file repeatedly.
→ **Repeat All**: play all files repeatedly.
→ **Off**: switches off the shuffle or repeat mode.

Repeat A-B (DVD/VCD/CD/MP3/DivX/WMA)

- 1 Press **A-B** at your chosen starting point.
- 2 Press **A-B** again at your chosen end point.
→ The section A and B can be set only within the same chapter/track.
→ The section will now repeat continuously.
- 3 To exit the sequence, press **A-B** again.

Program (not for Picture CD)

To select favourite tracks/chapters for playback in preferred sequence.

For DVD/VCD/CD

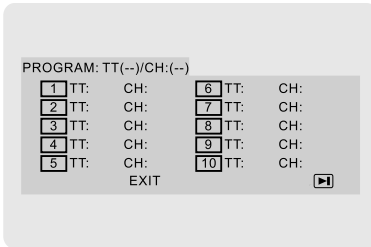

(DVD program for example)

- 1 Press **PROGRAM** on the remote to enter the program mode.
- 2 Use the **Numerical Keypad (0-9)** to directly input the tracks or chapters (single track number with digit "0" in front, for example "05").
- 3 Move the cursor by pressing **◀ ▶ ▲ ▼** to select **START**.
- 4 Press **OK** to start playback.

For MP3/WMA

- 1 In Stop mode, press **DISC MENU** to switch the menu between Album and Filelist.
- 2 When Filelist is on the screen, press **▲ ▼** to select the files and press **PROGRAM** to add the files to the program list.
- 3 Press **DISC MENU** to display the program list.
- 4 Press **PROGRAM** to delete unwanted files from the program list.

Forward/Reverse Searching (DVD/VCD/DivX/CD/MP3/WMA)

- 1 Press **◀/▶** on the remote during playback to select the required speed: 2X, 4X, 8X, 16X or 32X (backward or forward).
→ Sound will be muted.
- 2 To return to normal speed, press **▶II**

Time search & search by chapter/track number (DVD/VCD/CD/MP3/WMA)

- 1 Press **GOTO** until the time or chapter/track edit box appears.
- 2 Enter hours, minutes and seconds from left to right in the time edit box using remote control numerical keypad.

OR

Enter your desired chapter/track number in the chapter/track edit box using remote control numerical keypad.

Information display during playback (not for Picture CD)

- During playback, press **DISPLAY** to show disc information on the TV screen.

For DVD

- **Title/Chapter Elapsed**: displays the elapsed time of the current title/chapter.
- **Title/Chapter Remain**: displays the remaining time of the current title/chapter.
- **Display Off**: switches time display off.

Disc Operations

For SuperVCD/VCD/DivX/CD

- **Single/Total Elapsed**: displays the elapsed time of the current single/total track.
- **Single/Total Remain**: displays the remaining time of the current single/total track.
- **Display Off**: switches time display off.

Special disc features

Playing a Title (DVD)

- 1 Press **DISC MENU**.
→ The disc title menu appears on the TV screen.
- 2 Use **◀▶▲▼** or **Numeric Keypad (0-9)** to select a play option.
- 3 Press **OK** to confirm.

Changing the Audio Language (for DVD recorded with multiple languages)

- Press **AUDIO** repeatedly to select different audio languages.

Changing the Audio Channel (for VCD only)

- Press **AUDIO** to select the available audio channels provided by the disc (Mono Left, Mono Right or Stereo).

Subtitles (DVD)

- Press **SUBTITLE** repeatedly to select different subtitle languages.

Playing MP3/WMA/JPEG Picture disc

IMPORTANT!

You have to turn on your TV and set to the correct Video In channel. (See "Setting up the TV").

Playing MP3/WMA disc

IMPORTANT!

For DRM protected WMA files, use **Windows Media Player 10 (or later)** for CD burning/conversion. Visit www.microsoft.com for details about **Windows Media Player and WM DRM (Windows Media Digital Rights Management)**.

General operation

- 1 Load an MP3/WMA disc.
→ The data disc menu appears on the TV screen.
- 2 Use **▲ ▼** to select an album and press **OK** to open the album.

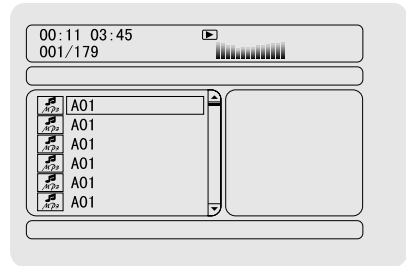

- 3 Press **▲ ▼** or use the **Numeric Keypad (0-9)** to highlight a track.
- 4 Press **OK** to confirm.
→ The playback will start from the selected track to the end of the album.

Note:

- The disc reading time may exceed 10 seconds due to large number of songs compiled onto the disc.

Playback selection

During playback, you can:

- Press **◀ / ▶** to select another track in the current album.
- Press **▶||** repeatedly to pause/resume playback.
- Press **DISC MENU** on the remote to switch between Album and Filelist.

Playing JPEG Picture CD

General operation

- 1 Load a JPEG Picture CD.
→ The data disc menu appears on the TV screen.
- 2 Use ▲▼ to select a folder and press **OK** to open the folder.
- 3 Press ▲▼ or use the **Numeric Keypad (0-9)** to highlight a picture file.
- 4 Press **OK** to confirm.
→ The playback will start from the selected picture to the end of the folder.

Playback selection

During playback, you can:

- Press ◀ / ▶ to select another file in the current folder.
- Use ◀ ▶ on the remote to rotate/flip the picture files.
- Press ▶|| repeatedly to pause/resume playback.
- Press **DISC MENU** on the remote to switch between Folder and Filelist.

Special JPEG features

Preview function (JPEG)

This function shows the content of the current folder or the whole disc.

- 1 Press **STOP** ■ during playback.
→ Thumbnails of 12 pictures appears on the TV screen.

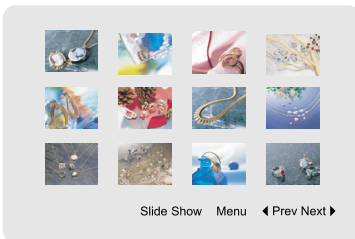

- 2 Use ◀ ▶ ▲ ▼ to highlight one of the pictures/ "Slide Show" and press **OK** to start playback/ slide show.

To enter the remote key function menu

- Use ◀ ▶ ▲ ▼ to highlight "Menu" and press **OK**.

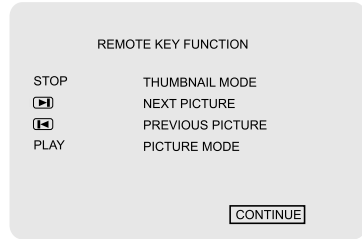

To display the other pictures on the previous/next page

- Press ◀ / ▶.
- Use ◀ ▶ ▲ ▼ to highlight "Prev" or "Next" and press **OK**.

Zoom picture (JPEG)

- During playback, press **ZOOM** repeatedly to display the picture with different scales.
- Use ◀ ▶ ▲ ▼ to view the zoomed picture.

Playback with multi-angles (JPEG)

- During playback, press ◀ ▶ to rotate the picture on the TV screen.
◀: rotate the picture anti-clockwise.
▶: rotate the picture clockwise.

Disc Operations

Playing a DivX disc

This DVD player supports the DivX movie playback that you download from your computer onto a CD-R/RW (see "System Menu Options-DIVX(R) VOD registration code" for more information).

- 1 Load a DivX disc.
→ Playback will start automatically. If not press **▶||**
 - 2 If the DivX movie contains external subtitles, the subtitle menu will appear on the TV screen for your selection.
- In this case, pressing **SUBTITLE** on the remote control will turn on or off the subtitle.
 - If multilingual subtitles are embedded on the DivX disc, pressing **SUBTITLE** will change the subtitle language during playback.

Note:

- *Subtitle files with the following filename extensions (.srt, .smi, .sub, .ssa, .ass) are supported but do not appear on the file navigation menu.*
- *The subtitle filename have to be the same as the filename of the movie.*

System Menu Options

Basic operations

- 1 Press **SYSTEM MENU** to enter the Setup Menu.
- 2 Press ◀▶ to select a page to be set.
- 3 Press ▲▼ to highlight an option.
- 4 Enter its submenu by pressing ▶ or **OK**.
- 5 Move the cursor by pressing ▲▼ to highlight the selected item.
→ In cases of value setting, press ◀▶ to adjust values.
- 6 Press **OK** to confirm.

To return to the upper-level menu

- Press ◀ or **OK** (in cases of value adjustment).

To exit from the menu

- Press **SYSTEM MENU** again.
→ The settings will be stored in the player's memory even if the player is switched off.

Note:

- Some of the features in the System Menu Options are described in "Getting Started".

GENERAL SETUP PAGE

The options included in GENERAL SETUP PAGE are: "TV DISPLAY", "OSD LANGUAGE", "SCREEN SAVER" and "DIVX CODE".

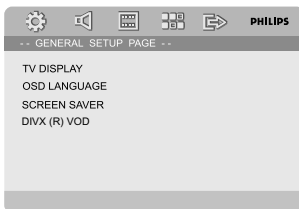

TV DISPLAY

Set the aspect ratio of the DVD Player according to the TV you have connected.

→ **NORMAL/PS**: If you have a normal TV and want both sides of the picture to be trimmed or formatted to fit your TV screen.

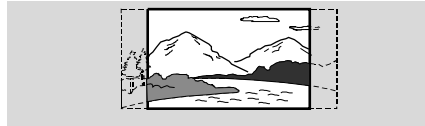

→ **4:3 NORMAL/LB**: If you have a normal TV. In this case, a wide picture with black bands on the upper and lower portions of the TV screen will be displayed.



→ **WIDE**: If you have a wide-screen TV.



OSD Language

See "Getting Started-Step 3: Setting language preference".

SCREEN SAVER

This function is used to turn the screen saver on or off.

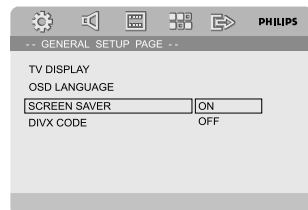

→ **ON**: In STOP, PAUSE or No DISC mode, if no actions are performed about 3 minutes, the screen saver will be activated.

→ **OFF**: Screen saver is disabled.

System Menu Options

DIVX VOD

Philips provides you the DivX® VOD (Video On Demand) registration code that allows you to rent and purchase videos using the DivX® VOD service.

For more information, visit us at www.divx.com/vod.

- In 'GENERAL SETUP PAGE', press ▲ ▼ to highlight DIVX VOD, then press ► or **OK** to enter its submenu and press **OK** again to confirm.

→ The registration code will appear.



- Press **OK** to exit.
- Use the registration code to purchase or rent the videos from DivX® VOD service at www.divx.com/vod. Follow the instructions and download the video onto a CD-R for playback on this DVD player.

Notes:

- All the downloaded videos from DivX® VOD can only be played back on this DVD player.
- Time search feature is not available during DivX movie playback.

AUDIO SETUP PAGE

The options included in AUDIO SETUP PAGE are: "ANALOG AUDIO SETUP", "DIGITAL AUDIO SETUP", "DOLBY DIGITAL SETUP", "3D", "HDCCD" and "NIGHT MODE".

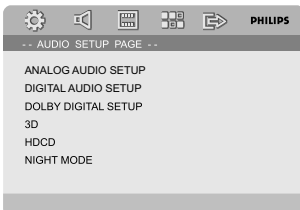

ANALOG AUDIO SETUP

The options included in ANALOG AUDIO SETUP page are: "LT/RT", "STEREO", "DVS REFER. MODE" and "DVS WIDE MODE".

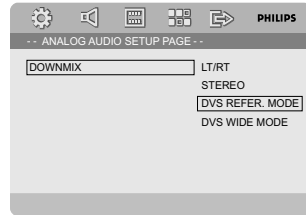

→ **LT/RT**: Selects the mixed sound output mode.

→ **STEREO**: Selects the ordinary stereo sound output.

→ **DVS REFER MODE**: Creates a highly compelling 5.1-channel listening environment similar to a small and well-damped room.

→ **DVS WIDE MODE**: Creates a highly compelling 5.1-channel listening environment similar to a larger room.

DIGITAL AUDIO SETUP

The options included in DIGITAL AUDIO SETUP page are: "OFF", "ALL" and "PCM ONLY".

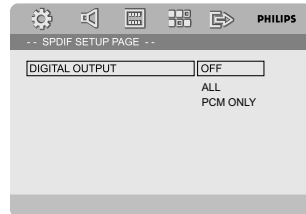

→ **OFF**: Turns off the SPDIF output.

→ **ALL**: If you have connected your DIGITAL OUT (COAXIAL) to a multi-channel decoder/receiver:

→ **PCM ONLY**: Only if your receiver is not capable of decoding multi-channel audio.

DOLBY DIGITAL SETUP

The option included in DOLBY DIGITAL SETUP is: "DUAL MONO".

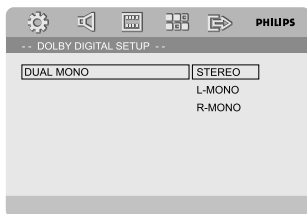

DUAL MONO

Select the setting that matches the number of speakers you have connected.

- **STEREO**: Left mono sound will send output signals to Left speaker and Right mono sound will send output signals to Right speaker.
- **L-MONO**: Left mono sound will send output signals to Left speaker and Right speaker.
- **R-MONO**: Right mono sound will send output signals to Left speaker and Right speaker.

3D

The option included in 3D page is: "REVERB MODE".

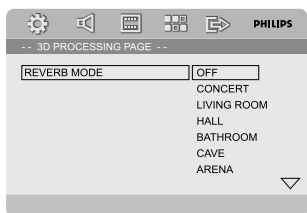

REVERB MODE

Reverb mode provides a virtual surround sound experience using just two speakers.

- **OFF, CONCERT, LIVING ROOM, HALL, BATHROOM, CAVE, ARENA** and **CHURCH**.

HDCCD

The option included in HDCCD (High Definition Compatible Digital) is: "FILTER".

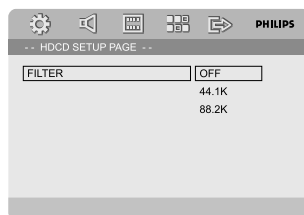

FILTER

Sets the audio output cutoff frequency point when playing an HDCCD disc.

- **OFF, 44.1K** and **88.2K**.

NIGHT MODE

In this mode, the high volume outputs are softened and low volume outputs are brought upward to an audible level. It is useful for watching your favourite action movie without disturbing others at night.

- **ON**: Select this to level out the volume. This feature is only available for movies with Dolby Digital mode.
- **OFF**: Select this when you want to enjoy the surround sound with its full dynamic range.

VIDEO SETUP PAGE

The options included in VIDEO SETUP PAGE are: "COMPONENT", "TV MODE", "PICTURE SETTING" and "HDMI SETUP".

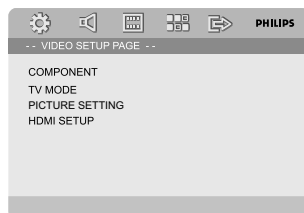

System Menu Options

COMPONENT

Sets the video output according to your video connection. This setting is not required if you are using the **AV OUT** jack to connect the DVD micro system to your TV.

→ **S-VIDEO**: Select this if you have connected the DVD micro system to your TV using S-Video jack.

→ **Pr/Cr Pb/Cb Y**: Select this if you have connected the DVD micro system to your TV using Component video jacks.

Notes:

- When the player is set to Y Pb Pr (YUV), some TV may not properly synchronise with the player on the SCART connector.
- This option is available only when the "HDMI" is set to "OFF".

TV MODE

Selects interlace or Progressive-SCAN video output mode when **Pr/Cr Pb/Cb Y** is selected.

→ **PROGRESSIVE-SCAN** and **INTERLACE**.

In the progressive scan mode, you can enjoy the high quality picture with less flickers. It only works when you have connected the DVD player's Y Pb Pr jacks to your TV that supports the progressive video input. Otherwise, a distorted picture will appear on the TV. For proper progressive scan set up, see "Getting started-Setting up Progressive Scan feature".

Note:

- This option is available only when the "HDMI" is set to "OFF".

PICTURE SETTING

This menu helps you to set the video quality.

- 1 Press **▲▼** to highlight "PICTURE SETTING".
- 2 Press **▶** or **OK** to enter PICTURE SETTING.

The options included in PICTURE SETTING page are: "SHARPNESS", "BRIGHTNESS", "CONTRAST", "GAMMA", "HUE", "SATURATION" and "LUMA DELAY".

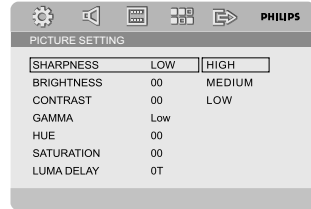

SHARPNESS

Adjusts the sharpness level.

→ **HIGH, MEDIUM** and **LOW**.

BRIGHTNESS

Adjusts the brightness level. Range: -20-+20.

CONTRAST

Adjusts the contrast level. Range: -16-+16.

GAMMA

Adjusts the gamma level.

→ **HIGH, MEDIUM, LOW** and **NONE**.

HUE

Adjusts the hue level. Range: -9-+9.

SATURATION

Adjusts the saturation level. Range: -9-+9.

LUMA DELAY

Adjusts the luma delay.

→ **0T** and **1T**.

HDMI SETUP

The options included in HDMI SETUP Page are: "HDMI" and "RESOLUTION".

HDMI

This option is used to enable/disable HDMI output.

- **ON**: Enables HDMI output.
- **OFF**: Disables HDMI output.

RESOLUTION

You can select the resolution of the picture according to your preference and the connected HDMI TV.

The resolution options include 480p (60Hz), 720p (60Hz), 1080i (60Hz), 576p (50Hz), 720p (50Hz) and 1080i (50Hz).

Notes:

- This option is available only when the "HDMI" is set to "ON".
- If no display appears on the TV screen due to unsupported resolution, reconnect any available interlace video output to your display and re-adjust the resolution settings to 480p/576p.

PREFERENCE PAGE

The options included in Preference page are: "TV TYPE", "AUDIO", "SUBTITLE", "DISC MENU", "PARENTAL", "DEFAULT" and "PASSWORD SETUP".

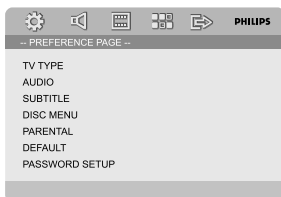

Note:

- Preference features can be selected only when no disc is in the player or when playback has stopped completely.

PARENTAL

Some DVDs may have a parental level assigned to the complete disc or to certain scenes on the disc. This feature lets you set a playback limitation level.

The rating levels are from 1 to 8 and are country dependent. You can prohibit the playing of certain discs that are not suitable for your children or have certain discs played with alternative scenes.

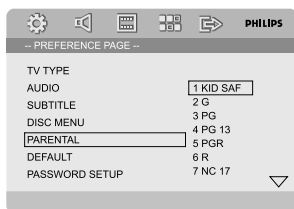

- VCD, SVCD and CD have no level indication, so parental control function has no effect on those kinds of discs. This applies to most illegal DVD

discs.

- 1 Press ▲ ▼ to highlight "PARENTAL".
- 2 Enter its submenu by pressing ►.
- 3 Use ▲ ▼ to highlight a rating level for the disc inserted.
 - DVDs that are rated above the level you selected will not play unless you enter your four-digit password and choose a higher level rating.

Note:

- Some DVDs are not encoded with a rating though the movie rating may be printed on the Disc cover. The rating level feature does not work for such Discs.

Rating explanations

1 KID SAF

- Kids material; recommended especially for children and viewers of all ages.

2 G

- General Audience; recommended as acceptable for viewers of all ages.

3 PG

- Parental Guidance suggested.

4 PG 13

- Material is unsuitable for children under age 13.

5-6 PGR, R

- Parental Guidance - Restricted; recommended that parents restrict children under 17 from viewing or allow to view only when supervised by a parent or adult guardian.

7 NC-17

- No children under age 17; not recommended viewing for children under age 17.

8 Adult

- Mature materials; should be viewed only by adults due to graphic sexual material, violence or language.

DEFAULT

Setting the "DEFAULT" function will reset all options and your personal settings to the factory defaults and all your personal settings will be erased.

Caution!

- When this function is activated, all settings will be reset to factory defaults.

System Menu Options

PASSWORD SETUP PAGE

The options included in Password Setup page are: "PASSWORD MODE" and "PASSWORD".

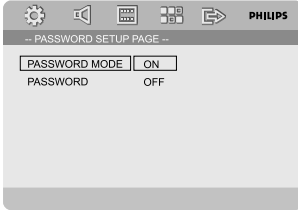

PASSWORD MODE

This feature is used to enable/disable password by selecting "ON"/"OFF".

PASSWORD

Enter your four digit password when a hint is displayed on the screen. The default password is 1234.

- 1 Press ▲▼ to highlight "PASSWORD".
- 2 Enter its submenu by pressing ►.
- 3 Press **OK** to open the page for inputting a new password.

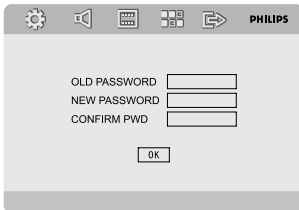

- 4 Enter the existing 4-digit code.
- 5 Enter a new 4-digit code.
- 6 Enter the new 4-digit code a second time to confirm.
→ The new 4-digit code will take effect.
- 7 Press **OK** to exit.

Notes:

- If the password has been changed, the parental and disc lock code will also be changed.
- The default password (1234) is always active even the password has been changed.

Radio Reception

Tuning to radio stations

- 1 Press **STANDBY-ON** (⏻) (⏻ on the remote) to switch on the last selected source.
- 2 Press **SOURCE (TUNER)** on the remote) to select FM mode.
- 3 Press and hold ◀ / ▶ on the remote until the frequency indication starts to change, then release.
→ The system automatically tunes to the next strong radio station.
- To tune to a weak station, press ◀ / ▶ on the remote briefly and repeatedly until an optimal reception is found.
- 4 Repeat Step 3 if necessary until you find the desired radio station.

Presetting radio stations

You can preset up to 40 stations regardless of the reception.

Automatic programming

- Press **PROGRAM** on the remote for more than two seconds to activate programming.
→ All available stations are programmed.

Manual programming

- 1 Tune to your desired radio station (refer to "Tuning to radio stations").
- 2 Press **PROGRAM** on the remote.
→ "PROG" icon flashes.
- 3 Press ◀ / ▶ to select the desired preset number.
→ If "PROG" icon goes off before you select the desired preset number; press **PROG** on the remote.
- 4 Press **PROGRAM** on the remote again to store the radio station.
- Repeat steps 1-4 to store other radio stations.

Listening to preset radio stations

- In tuner mode, press ◀ / ▶ to select the desired preset number.
→ The preset number, radio frequency, and waveband are displayed.

RDS

Radio Data System is a service that allows FM stations to show additional information. If you are receiving a RDS station, **RDS** and the station name are displayed.

When automatic programming is used, RDS stations will be programmed first.

Scrolling through different RDS information

- Press **CLOCK/RDS** briefly and repeatedly to scroll through the following information (if available):
 - Station name
 - Radio text messages
 - Frequency

Setting the RDS clock

Some RDS radio station may be transmitting a real clock time at an interval of every minute. It is possible to set the clock by using a time signal which is broadcast together with the RDS signal.

- 1 Tuned to an RDS station from FM band (refer to "Tuning to radio stations").
- 2 Press and hold **CLOCK/RDS** for more than two seconds.
- 3 Press **CLOCK/RDS** again.
→ "SEARCH TM" is displayed.
→ When RDS time is read, "RDS" and RDS time value are displayed and the current time will be stored.

Note:

- Some RDS radio station may be transmitting a real time clock at a minute interval. The accuracy of the transmitted time depends on the transmitting RDS radio station.

Other Functions

Setting the clock

- 1 In Standby mode, press and hold **CLOCK/RDS** on the remote until the time flashes on the display.
→ "CLOCK" is displayed briefly. Then, the hour digits flash on the display screen.
- 2 Press **VOLUME +/- (VOL+/-)** on the remote) to set the hours and **CLOCK/RDS to confirm**.
→ The minute digits flash on the display screen.
- 3 Press **VOLUME +/- (VOL+/-)** on the remote) to set the minutes and **CLOCK/RDS to confirm**.

Notes:

- This system only supports 24-hour mode.
- The clock setting will be erased when the system is disconnected from the power supply.
- The system will exit clock setting mode if no button is pressed within 30 seconds.

Setting sleep/wake-up timer

Sleep timer setting

In power-on mode, the sleep setting enables the system to switch to standby mode automatically at a preset time.

- 1 In power-on mode, press **SLEEP/TIMER** on the remote repeatedly to select a preset time.
→ The selections are as follows (time in minutes):
00 → 10 → 20 → 30 → 40 → 50 → 60 → 70
→ 80 → 90 → 00
- 2 When you reach the desired length of time, stop pressing **SLEEP/TIMER**.
→ .z appears.

To deactivate the sleep timer

- Press **SLEEP/TIMER** repeatedly until "00" is displayed, or press **ECO POWER/STANDBY-ON**  (on the remote).

In standby mode, the timer setting enables the system to switch on automatically at a set time.

Wake-up timer setting

IMPORTANT!

– Before setting the timer, ensure that the clock is set correctly.

- 1 Press and hold **SLEEP/TIMER** until the time flashes on the display.
→ "TIMER" scrolls. Then, the hour digits flash on the display screen.
- 2 Press **VOLUME +/- (VOL+/-)** on the remote) to set the hours and **SLEEP/TIMER to confirm**.
→ The minute digits flash on the display screen.
- 3 Press **VOLUME +/- (VOL+/-)** on the remote) to set the minutes and **SLEEP/TIMER to confirm**.
→ "OFF" flashes on the display screen.
- 6 Press **VOLUME +/- (VOL+/-)** on the remote) to select "ON".
→  icon appears on the display screen.

To deactivate the timer

- Select "OFF" at Step 6.

Using a non-USB device

- 1 Connect the system's **LINE-IN** jack to the **AUDIO OUT** jacks on another audio/visual device (such as a VCR, Laser Disc player or cassette desk) using a "single-to-double" cinch cable (with one end providing a 3.5" connector for connection to the **LINE-IN** jack while the other end providing two white/red connectors for connection to the other device's AUDIO OUT jacks).
- 2 Press **AUX** to select external equipment.
→ "LINE-IN" is displayed.

Note:

- All the sound control features (DSC or DBB, for example) are available for selection.
- Refer to the operating instructions for the connected equipment for details.

Using a USB mass storage device

By connecting a USB mass storage device to the Hi-Fi system, you can enjoy the device's stored music through the powerful speakers of Hi-Fi system.

Playing a USB mass storage device Compatible USB mass storage devices

- With the Hi-Fi system, you can use:
- USB flash memory (USB 2.0 or USB1.1)
 - USB flash players (USB 2.0 or USB1.1)
 - memory cards (requires an additional card reader to work with this Hi-Fi system)

Notes:

- In some USB flash players (or memory devices), the stored contents are recorded using copyright protection technology. Such protected contents will be unplayable on any other devices (such as this Hi-Fi system).
- Compatibility of the USB connection on this product:
 - a) This product supports most USB Mass storage devices (MSD) that are compliant to the USB MSD standards.
 - i) Most common Mass storage class devices are flash drives, memory sticks, jump drives

and etc.

- ii) If you see a "Disc Drive" show up on your computer after you plugged the mass storage device into your computer, most likely it is MSD compliant and it will work with this product.
- b) If your Mass storage device required a battery/ power source. Please make sure you have a fresh battery in it or charge the USB device first and then plug it into the product again.
 - Supported Music type:
 - a) This device only supports unprotected music with the following file extension:
.mp3
.wma
 - b) Music bought from on-line music stores are not supported because they are secured by Digital Rights Management protection (DRM).
 - c) File name extensions that end with the following are not supported:
.wav; .m4a; .m4p; .mp4; .aac and etc.
 - No Direct connection can be made from Computer USB port to the product even you have either or both mp3 or wma files in your computer.

Supported formats:

- USB or memory file format FAT12, FAT16, FAT32 (sector size: 512 bytes)
- MP3 bit rate (data rate): 32-320 Kbps and variable bit rate
- WMA v9 or earlier
- Directory nesting up to a maximum of 8 levels
- Number of albums/ folders: maximum 99
- Number of tracks/titles: maximum 999
- ID3 tag v2.0 or later
- File name in Unicode UTF8 (maximum length: 128 bytes)

The system will not play or support the following:

- Empty albums: an empty album is an album that does not contain MP3/WMA files, and will not be shown in the display.
- Non-supported file formats are skipped. This means that e.g.: Word documents .doc or MP3 files with extension .dlf are ignored and will not be played.
- AAC, WAV, PCM audio files
- DRM protected WMA files
- WMA files in Lossless format

External Sources

How to transfer music files from PC to a USB mass storage device

By dragging and dropping music files, you can easily transfer your favorite music from PC to a USB mass storage device.

For the flash player; you can also use its music management software for the music transfer:

However, those WMA files may be unplayable for compatibility reasons.

How to organize your MP3/WMA files on the USB mass storage device

This Hi-Fi system will browse the MP3/WMA

files in the folders/sub-folders/titles order:

Example:

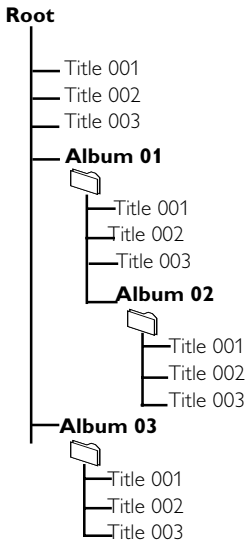

Organize your MP3/WMA files in different folders or subfolders as required.

Notes:

– If you have not organized MP3/WMA files into any albums on your disc, an album "01" will be automatically assigned for all those files.

– Make sure that the file names of MP3 files end with `.mp3`, and the file names of WMA files end with `.wma`.

– For DRM protected WMA files, use Windows Media Player 10 (or later) for conversion. Visit www.microsoft.com for details about Windows Media Player and WM DRM (Windows Media Digital Rights Management).

- 1 Check the USB device has been properly connected. (See Installation: Connecting an additional appliance).
- 2 Press **SOURCE (USB)** on the remote) once or more to select USB.
 - **NO FILE** appears if no audio file is found in the USB device.
- 3 Play the USB's audio files as you do with the albums/tracks on a CD (See CD/MP3 Operations).

Notes:

– For compatibility reasons, the album/track information may differ from what it is displayed through flash players' music management software.

– File names or ID3 tags will be displayed as — if they are not in English.

SYSTEM

Total output power	400W RMS
Power supply	220 – 240 V / 50 Hz
Rated working power consumption (1/8 rated output power)	≤ 85W
AUX input sensitivity	≤ 500mV
Channel Separation	≥ 40dB
Distortion	0.7%
Eco power Standby	< 1W

DVD

Frequency response	100Hz-20kHz (+0.5/-2 dB)
Video output	1 V _{P-P}
HDMI 480p (60Hz), 720p (60Hz), 1080i (60Hz), 576p (50Hz), 720p (50Hz), 1080i (50Hz)	
Horizontal definition	500 (TV)
Dimensions .	430 (W) × 225 (H) × 141 (D) mm
Weight	2.13 kg

AMPLIFIER

Rated output power (THD = 10%)	2x75W (4Ω)
Frequency response	100Hz-20kHz (+0.5/-2 dB)
S/N Ratio	≥ 60dB
Loaded impedance	4 Ω

TUNER

FM Frequency range	87.5-108 MHz
FM Noise limit sensitivity	≤ 20μV/M
FM S/N	≥ 46dB

SPEAKER

Impedance	4 Ω
Output power	75W
Sensitivity	80 ± 4dB
Frequency response	80Hz-16kHz
Dimensions .	198 (W) × 649 (H) × 163 (D) mm
Weight	3.66 kg each

SUBWOOFER

Subwoofer (not magnetically shielded design)	8" (active)
Impedance	8 Ω
Dimensions .	430 (W) × 265 (H) × 292 (D) mm
Weight	8.6 kg
Output power	150W

REMOTE

Distance	6m
Angle	± 30°



Specifications subject to change without prior notice

Troubleshooting

WARNING

Under no circumstances should you try to repair the system yourself, as this will invalidate the warranty. Do not open the system as there is a risk of electric shock.

If a fault occurs, first check the points listed below before taking the system for repair. If you are unable to remedy a problem by following these hints, consult your dealer or Philips for help.

Problem	Solution
No power.	<ul style="list-style-type: none">✓ Check if the AC power cord is properly connected.✓ Press ECO POWER/STANDBY-ON  on the top of the DVD micro system or  on the remote to turn on the power.
No picture.	<ul style="list-style-type: none">✓ Check if the TV is switched on.✓ Check the video connection.✓ Press SOURCE on the top of the DVD player repeatedly to select "DVD" or press DISC on the remote.✓ Set your TV to the correct Video In channel. This channel is usually near channel 00. Or, you may have a button on the TV remote control that selects Auxiliary or A/V IN channel. See your TV owner's manual for details. Or, change channels at the TV until you see DVD screen on the TV.✓ If the progressive scan feature is activated but the connected TV does not support progressive signals or the cables are not connected accordingly, see "Getting started-Setting up Progressive Scan feature" for proper progressive scan setup or deactivate the progressive scan feature as below:<ol style="list-style-type: none">1) Turn off your TV progressive scan mode or turn on to interlaced mode.2) Press SYSTEM MENU on the remote to exit the system menu and then DISC 1 (or DISC 2) and "1" to exit progressive scan.
Distorted or poor picture.	<ul style="list-style-type: none">✓ Sometimes a small amount of picture distortion may appear. This is not a malfunction.✓ Clean the disc.
Completely distorted picture or black/white picture.	<ul style="list-style-type: none">✓ TV has a colour system standard. If the disc's or DVD system's colour system is different than your TV's colour system, the picture may be distorted or colourless.

The aspect ratio of the screen cannot be changed even though you have set the TV shape.

No sound or distorted sound.

The micro DVD player does not start playback.

The DVD micro system does not respond when the buttons are pressed.

Cannot activate some features, such as Angles, Subtitles, or multi-language Audio.

Considerable noise in radio broadcasts.

- ✓ The aspect ratio is fixed on the DVD disc.
- ✓ Depending on the TV, it may not be possible to change the aspect ratio.

- ✓ Adjust the volume.
- ✓ Check that the speakers are connected correctly.
- ✓ Replace the speaker cables.
- ✓ Disconnect the headphones.
- ✓ The system is in pause, slow motion or fast forward/reverse mode, press ► || to resume normal play mode.

- ✓ Insert a readable disc with the playback side facing down.
- ✓ Check the disc type, colour system and regional code. Check for any scratches or smudges on the disc.
- ✓ Press SYSTEM MENU to turn off the setup menu screen.
- ✓ Cancel the parental control rating function or change the rating level.
- ✓ Moisture has condensed inside the system. Remove the disc and leave the system turned on for about an hour.

- ✓ Disconnect the power plug from the outlet and insert again.

- ✓ Multi-language sound or subtitle is not recorded on the DVD.
- ✓ Changing the language for the sound or subtitle is prohibited on the DVD.
- ✓ The features may not be available on the disc.

- ✓ Tune in to the correct frequency.
- ✓ Connect the antennas.
- ✓ Fully extend the FM wire antenna. Position for best reception and secure to a wall.
- ✓ Connect an outdoor FM antenna.
- ✓ Adjust the direction and position for best reception.
- ✓ Place the antenna farther away from any equipment that may be causing the noise.
- ✓ Increase the distance between the system and your TV or other equipment.

Troubleshooting

The remote control does not function.

- ✓ Select the correct source (DISC or TUNER, for example) before pressing the function button.
- ✓ Point the remote control at the remote sensor of the unit.
- ✓ Reduce the distance to the player.
- ✓ Remove any possible obstacles.
- ✓ Replace the batteries with new ones.
- ✓ Check that the batteries are loaded correctly.

The display is dark.

- ✓ Press DIM again.

Low hum or buzz sound.

- ✓ Place the DVD micro system as far away as possible from electrical devices that may be causing interference.

Low bass response.

- ✓ Check all speakers for correct polarity.

Unable to select Progressive Scan.

- ✓ Check that the output of the video signal is switched to 'Pr/Cr Pb/Cb Y'.

No sound is output from the HDMI jack.

- ✓ Check the connection between the TV and the HDMI jack of the DVD player.
- ✓ See if the TV supports this 480p/576p/720p/1080i DVD player.
- ✓ Check your TV system setup correctly.

No sound and picture

- ✓ Check that the RGB/SCART cable is connected to the correct device (See Connecting TV).

Analog: Sound that has not been turned into numbers. Analog sound varies, while digital sound has specific numerical values. These jacks send audio through two channels, the left and right.

Aspect ratio: The ratio of vertical and horizontal sizes of a displayed image. The horizontal vs. vertical ratio of conventional TVs. is 4:3, and that of wide-screens is 16:9.

AUDIO OUT Jacks: Jacks on the back of the DVD System that send audio to another system (TV set, Stereo, etc.).

Bit Rate: The amount of data used to hold a given length of music; measured in kilobits per second, or kbps. Or, the speed at which you record. Generally, the higher the bit rate the better the sound quality. However, higher bit rates use more space on a Disc.

Chapter: Sections of a picture or a music piece on a DVD that are smaller than titles. A title is composed of several chapters. Each chapter is assigned a chapter number enabling you to locate the chapter you want.

Component Video Out Jacks: Jacks on the back of the DVD System that send high-quality video to a TV set that has Component Video In jacks (R/G/B, Y/Pb/Pr, etc.).

Disc menu: A screen display prepared for the selection of images, sound, subtitles, multi-angles, etc recorded on a DVD.

Digital: Sound that has been converted into numerical values. Digital sound is available when you use the DIGITAL AUDIO OUT COAXIAL or OPTICAL jacks. These jacks send audio through multiple channels, instead of just two channels as analog does.

Dolby Digital: A surround sound system developed by Dolby Laboratories containing up to six channels of digital audio (front left and right, surround left and right and center).

JPEG: A still-picture data compression system proposed by the Joint Photographic Expert Group, which features small decrease in image quality in spite of its high compression ratio.

MP3: A file format with a sound data compression system, "MPE" is the abbreviation of Motion Picture Experts Group 1 (or MPEG-1) Audio Layer 3. Through the MP3 format, one CD-R or CD-RW can contain about 10 times as much data volume as a regular CD can.

Multichannel: DVD is specified to have all sound tracks constitute one sound field. Multichannel refers to a structure of sound tracks having three or more channels.

Parental control: A function of the DVD to limit playback of the disc by the age of the users according to the limitation level in each country. The limitation varies from disc to disc; when it is activated, playback will be prohibited if the software's level is higher than the user-set level.

PCM (Pulse Code Modulation): A system for converting analog sound signal to digital signal for later processing without data compression.

Playback control (PBC): Refers to the signal recorded on video CDs or SVCDs for reproduction control. By using screen menus recorded on a Video CD or SVCD that supports PBC, you can enjoy interactive-type software as well as software having a search function.

Progressive Scan (P-Scan): It displays all the horizontal lines of a picture at one time, as a signal frame. This system can convert interlaced video from DVD into progressive format for connection to a progressive display. It dramatically increases the vertical resolution. A progressive scan TV set is needed to receive progressive scan output from the system.

Region code: A system allowing discs to be played only in preset regions. This unit will only play discs that have compatible region codes. You can find the region code of your unit from the product label. Some discs are compatible with more than one region (or ALL regions).

S-Video: Produces a clear picture by sending separate signals for luminance and the color. You can use S-Video only if your TV set has S-Video In jack.

Sampling Frequency: Frequency of data sampling when analog data is converted to digital data. Sampling frequency numerically represents how many times the original analog signal is sampled per second.

Surround: A system for users to create realistic three-dimensional sound fields full of realism by arranging multiple speakers around the listener.

Title: The longest section of a picture or music feature on DVD, music, etc., in video software, or the entire album in audio software. Each title is assigned a title number enabling you to locate the title you want.

VIDEO OUT jack: Jack on the back of the DVD System that sends video to TV.

HDMI: High Definition Multimedia Interface. A specification developed by the HDMI Working Group that combines multi-channel audio and high definition video and that controls signals into a single digital interface for use with DVD players, digital television, and other audiovisual devices.

Meet Philips at the Internet
<http://www.philips.com>

English

Français

Español

Deutsch

Nederlands

Italiano

Svenska

Dansk

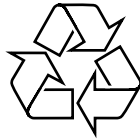

MCD988

