

Always there to help you

Register your product and get support at
www.philips.com/welcome

BTM5000/12



User manual

PHILIPS

Contents

1	Safety and Notice	2
	Safety	2
	Notice	3

2	Your Micro System	4
	Introduction	4
	What's in the box	4
	Overview of the main unit	5

3	Get started	7
	Connect speakers	7
	Connect FM antenna	7
	Connect power	8
	Prepare the remote control	8
	Set clock	9
	Turn on	9
	Demonstrate the unit's features	9

4	Play	10
	Play a disc	10
	Play from USB	11
	Play from a Bluetooth device	11

5	Listen to radio	12
	Tune to a radio station	12
	Program radio stations automatically	12
	Program radio stations manually	13
	Select a preset radio station	13
	Select stereo/mono broadcast	13
	Show RDS information	13

6	Adjust sound	14
	Adjust volume	14
	Select a preset sound effect	14
	Mute sound	14

7	Other features	14
	Set the sleep timer	14
	Set the alarm timer	14
	Play from external audio device	15

	Adjust display brightness	15
	Headphone	15

8	Product information	16
	Specifications	16
	USB playability information	16
	Supported MP3 disc formats	17
	Bluetooth	17
	Maintenance	17

9	Troubleshooting	18
----------	------------------------	----

1 Safety and Notice

Read and understand all instructions before you use this product. If damage is caused by failure to follow the instructions, the warranty does not apply.

Safety

Safety

Warning

- Never remove the casing of this apparatus.
 - Never lubricate any part of this apparatus.
 - Never look into the laser beam inside this apparatus.
 - Never place this apparatus on other electrical equipment.
 - Keep this apparatus away from direct sunlight, naked flames or heat.
 - Ensure that you always have easy access to the power cord, plug or adaptor to disconnect the apparatus from the power.
-
- The device shall not be exposed to dripping or splashing.
 - Do not place any source of danger on the device (e.g. liquid filled objects, lit candles).
 - Where the MAINS plug or an appliance coupler is used as the disconnect device, the disconnect device shall remain readily operable.
 - Make sure that there is enough free space around the product for ventilation.
 - Only use attachments/accessories specified by the manufacturer.

Care for your product

- Do not insert any objects other than discs into the disc compartment.

- Do not insert warped or cracked discs into the disc compartment.
- Remove the discs from the disc compartment if you are not using the product for an extended period of time.
- Only use microfiber cloth to clean the product.

Care of the environment



Your product is designed and manufactured with high quality materials and components, which can be recycled and reused.



When this crossed-out wheeled bin symbol is attached to a product it means that the product is covered by the European Directive 2002/96/EC.

Please inform yourself about the local separate collection system for electrical and electronic products.

Please act according to your local rules and do not dispose of your old products with your normal household waste. Correct disposal of your old product helps to prevent potential negative consequences for the environment and human health.



Your product contains batteries covered by the European Directive 2006/66/EC, which cannot be disposed with normal household waste. Please inform yourself about the local rules on separate collection of batteries because correct disposal helps to prevent negative consequences for the environmental and human health.

Compliance



This product complies with the radio interference requirements of the European Community.

CE 0890

This product complies with the requirement of the 1999/5/EC directive.

This apparatus includes this label:



Note

- The type plate is located on the bottom of the apparatus.

Hearing safety



Warning

- To prevent possible hearing damage, do not listen at high volume levels for long periods.

Listen at a moderate volume.

- Using headphones at a high volume can impair your hearing. This product can produce sounds in decibel ranges that may cause hearing loss for a normal person, even for exposure less than a minute. The

higher decibel ranges are offered for those that may have already experienced some hearing loss.

- Sound can be deceiving. Over time your hearing 'comfort level' adapts to higher volumes of sound. So after prolonged listening, what sounds 'normal' can actually be loud and harmful to your hearing. To guard against this, set your volume to a safe level before your hearing adapts and leave it there.

To establish a safe volume level:

- Set your volume control at a low setting.
- Slowly increase the sound until you can hear it comfortably and clearly, without distortion.

Listen for reasonable periods of time:

- Prolonged exposure to sound, even at normally 'safe' levels, can also cause hearing loss.
- Be sure to use your equipment reasonably and take appropriate breaks.

Be sure to observe the following guidelines when using your headphones.

- Listen at reasonable volumes for reasonable periods of time.
- Be careful not to adjust the volume as your hearing adapts.
- Do not turn up the volume so high that you can't hear what's around you.
- You should use caution or temporarily discontinue use in potentially hazardous situations. Do not use headphones while operating a motorized vehicle, cycling, skateboarding, etc.; it may create a traffic hazard and is illegal in many areas.

Notice

Any changes or modifications made to this device that are not expressly approved by Philips Consumer Lifestyle may void the user's authority to operate the equipment.

Environmental information

All unnecessary packaging has been omitted. We have tried to make the packaging easy to separate into three materials: cardboard (box), polystyrene foam (buffer) and polyethylene (bags, protective foam sheet.)

Your system consists of materials which can be recycled and reused if disassembled by a specialized company. Please observe the local regulations regarding the disposal of packaging materials, exhausted batteries and old equipment.



**Be responsible
Respect copyrights**

The making of unauthorized copies of copy-protected material, including computer programs, files, broadcasts and sound recordings, may be an infringement of copyrights and constitute a criminal offence. This equipment should not be used for such purposes.

Bluetooth

The Bluetooth® word mark and logos are registered trademarks owned by Bluetooth SIG, Inc. and any use of such marks by Philips is under license.

2 Your Micro System

Congratulations on your purchase, and welcome to Philips! To fully benefit from the support that Philips offers, register your product at www.philips.com/welcome.

Introduction

With this unit, you can enjoy audio from disc, USB mass storage devices, Bluetooth-enabled devices and other external devices, or listen to radio stations.

The unit supports the following media formats:



What's in the box

Check and identify the contents of your package:

- Main unit
- 2 x Speakers
- Remote control with 2 x AAA batteries
- FM antenna
- AC power cable
- 1 set front panel (for main unit)
- 1 set speaker grill
- Short user manual
- Safety & Notice sheet

Overview of the main unit

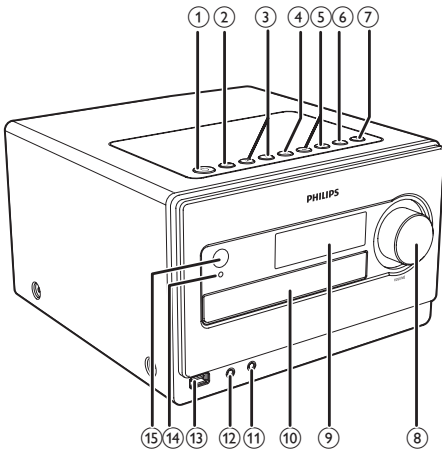

- ①
 - Turn on the unit, switch to Standby mode, or switch to Eco Power mode.
- ② **SOURCE**
 - Select a source: DISC, USB, TUNER, AUDIO IN, AUX, or BT.
- ③ /
 - Skip to the previous/next track.
 - Select a preset radio station.
 - Adjust time.
- ④
 - Start or pause play.
- ⑤
 - Press and hold the key to search within a track/disc/USB.
 - Turn to a radio station.
- ⑥
 - Stop play.
 - Erase a program.
 - In standby mode, turn on/off feature demonstration.
 - In BT mode, press and hold to clear Bluetooth pairing history.
- ⑦
 - Open/close the disc compartment.
- ⑧ **VOLUME**

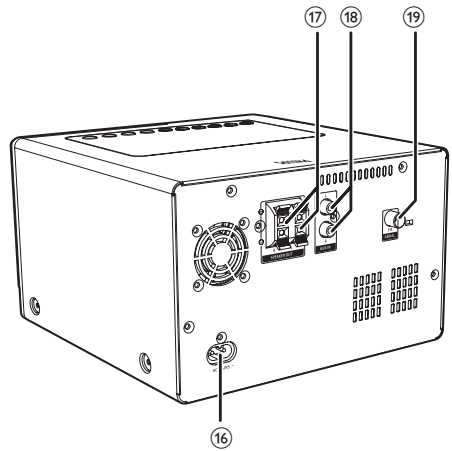

- Adjust volume.
- Adjust time.
- ⑨ **Display panel**
 - Show the current status.
- ⑩ **Disc compartment**
- ⑪
 - Headphone socket.
- ⑫ **AUDIO IN**
 - Connect an external audio device.
- ⑬
 - USB socket.
- ⑭ **Bluetooth indicator**
 - Lights up when the unit is connected with Bluetooth compatible device.
- ⑮ **IR sensor**
 - Detect signals from the remote control (always point the remote control towards the IR sensor).
- ⑯ **AC MAIN~**
 - Power supply socket.
- ⑰ **SPEAKER OUT**
 - Connect the speakers.
- ⑱ **AUX IN**
 - Connect an external audio device.

19 FM AERIAL

- Connect the FM antenna.

Overview of the remote control

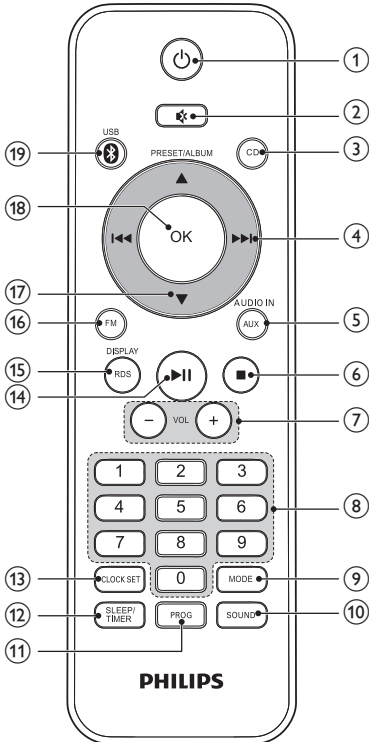

- ① **⏻**
 - Turn on the unit, or switch to Standby mode, or switch to Eco Power mode.
- ② **🔇**
 - Mute or restore volume.
- ③ **CD**
 - Select a disc source.

- ④ **⏮ / ⏭**
 - Skip to the previous/next track.
 - Tune to a radio station.
 - Press and hold the key to search within a track/disc/USB.
- ⑤ **AUX/AUDIO IN**
 - Select an external audio device source.
- ⑥ **■**
 - Stop play.
 - Erase a program.
 - In standby mode, turn on/off feature demonstration.
 - In BT mode, press and hold to clear Bluetooth pairing history.
- ⑦ **VOL +/-**
 - Adjust volume.
 - Adjust time.
- ⑧ **Numeric keypad**
 - Select a track from a disc/USB directly.
 - Select a preset radio station.
- ⑨ **MODE**
 - Select repeat/shuffle play.
- ⑩ **SOUND**
 - Select a preset sound setting.
- ⑪ **PROG**
 - Program tracks in disc/USB source.
 - Program radio stations.
- ⑫ **SLEEP/TIMER**
 - Set the sleep timer.
 - Set the alarm timer.
- ⑬ **CLOCK SET**
 - Set clock in standby mode.
 - Display the time in any source mode.
- ⑭ **▶||**
 - Start or pause play.
- ⑮ **RDS/DISPLAY**
 - Select RDS broadcast information.
 - Synchronize clock with RDS station.

- Select display information during play.
- Adjust display brightness in standby mode.

16 FM

- Select the FM radio source.

17 PRESET/ALBUM ▲ / ▼

- Skip to the previous/next album.
- Select a preset radio station.
- Adjust time.

18 OK

- Confirm a selection.
- Switch between STEREO and MONO in tuner source.

19 */USB

- Select the Bluetooth source.
- Select the USB source.

3 Get started



Caution

- Use of controls or adjustments or performance of procedures other than herein may result in hazardous radiation exposure or other unsafe operation.

Always follow the instructions in this chapter in sequence.

If you contact Philips, you will be asked for the model and serial number of this apparatus. The model number and serial number are on the rear of the apparatus. Write the numbers here:

Model No. _____

Serial No. _____

Connect speakers



Note

- For optimal sound, use the supplied speakers only.
- Connect only speakers with impedance that is the same or higher than the supplied speakers. Refer to the Specifications section of this manual.

Insert the speaker wires completely into the speaker input sockets on the back of the unit.

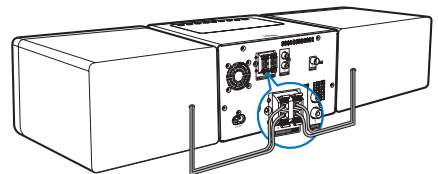

Connect FM antenna



Tip

- For optimal reception, fully extend and adjust the position of the antenna.

Connect the supplied FM antenna to the FM AERIAL socket on the main unit.

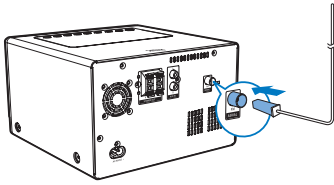

Connect power

! Caution

- Risk of product damage! Make sure that the power voltage corresponds to the voltage printed on the back or underside of the unit.
- Risk of electric shock! When you unplug the AC power cord, always pull the plug from the socket. Never pull the cord.
- Before connecting the AC power cord, ensure you have completed all other connections.

Connect the power cord to:

- the **AC MAIN~** socket on the main unit.
- the wall outlet.

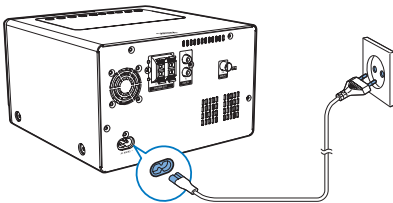

Prepare the remote control

! Caution

- Risk of explosion! Keep batteries away from heat, sunshine or fire. Never discard batteries in fire.

To insert the remote control battery:

- 1 Open the battery compartment.
- 2 Insert 2 AAA batteries with correct polarity (+/-) as indicated.
- 3 Close the battery compartment.

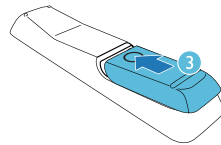
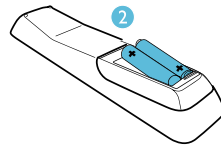
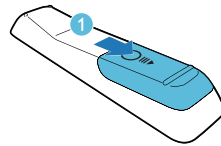

≡ Note

- If you are not going to use the remote control for a long time, remove the batteries.
- Do not use old and new or different types of batteries in combination.
- Batteries contain chemical substances, so they should be disposed of properly.

Set clock

Note

- You can set the clock in standby mode only.

- 1 In standby mode, press and hold **CLOCK SET** on the remote control to activate the clock setting mode.
 - ↳ **[CLOCK SET]** (clock set) is displayed briefly.
 - ↳ The 12 hour or 24 hour format is displayed.
- 2 Press **PRESET/ALBUM ▲ / ▼** to select 12 hour or 24 hour format.
- 3 Press **CLOCK SET** to confirm.
 - ↳ The hour digits begin to blink.
- 4 Press **PRESET/ALBUM ▲ / ▼** to set the hour.
- 5 Press **CLOCK SET** to confirm.
 - ↳ The minute digits begin to blink.
- 6 Press **PRESET/ALBUM ▲ / ▼** to set the minute.
- 7 Press **CLOCK SET** to confirm.

Note

- You can also press **VOL +/-** on remote control, or **◀ / ▶, VOLUME** on the main unit to set hour format/hour/minute.
- To exit clock setting mode without storing, press **■ /MENU**.
- If no button is pressed in 90 seconds, the system exits clock setting mode automatically.

Turn on

- Press **⏻**.
 - ↳ The unit switches to the last selected source.

Switch to standby

- Press **⏻** again to switch the unit to standby mode.
 - ↳ The clock (if set) appears on the display panel.

Switch to ECO Power mode:

- Press and hold **⏻** for more than three seconds.
 - ↳ **[ECOPOWER]** (Eco Power) is displayed briefly.

Tip

- The unit switches to Eco Power mode after 15 minutes in standby mode.

Switch between standby mode and Eco Power mode:

- In standby/Eco Power mode, press and hold **⏻** to switch the unit to Eco Power/standby mode.

Demonstrate the unit's features

- In standby mode, press **■ /MENU** until **[WELCOME TO PHILIPS]** (welcome to Philips) scrolls from the right to the left on the display, and then **[DEMO ON]** (demo on) is displayed briefly.
 - ↳ This system's features are displayed one by one.
- To turn off the demonstration, press **■ /MENU** again.

4 Play

Play a disc

- 1 Press **SOURCE** repeatedly to select DISC source.
- 2 Press **▲** to open the disc compartment.
- 3 Insert a disc with the printed side facing upward.
- 4 Press **▲** to close the disc compartment.
- 5 Play starts automatically. If not, press **▶||**.

Pause/resume play

- During play, press **▶||** to pause/resume play.

Skip to a track

For CD:

- Press **◀◀ / ▶▶** to select another track.
 - You can also press **◀ / ▶** on the main unit to select another track.
 - You can also press numeric keypad to select a track directly.

For MP3 disc and USB:

- 1 Press **PRESET/ALBUM ▲ / ▼** to select an album or a folder.
- 2 Press **◀◀ / ▶▶** to select a track or a file.

Note

- You can press numeric keypad directly to select a track or a file from the current album or folder.

Search within a track

- 1 During play, press and hold **◀◀ / ▶▶**.

- 2 Release to resume normal play.

Program tracks

Note

- You can program tracks only when the play stops.

You can program a maximum of 20 tracks.

- 1 Press **PROG** to activate the program mode.
 - ↳ **[PRG]** (program) is displayed.
- 2 For MP3/WMA tracks, press **PRESET/ALBUM ▲ / ▼** to select an album.
- 3 Press **◀◀ / ▶▶** to select a track, then press **PROG** to confirm.
- 4 Repeat steps 2 to 3 to program more tracks.
- 5 Press **▶||** to play the programmed tracks.
 - ↳ During play, **[PRG]** (program) is displayed.
 - To erase the program, in the stop position, press **■ / MENU**.

Display play information

- During play, press **RDS/DISPLAY** repeatedly to select different play information.
 - For CD: Lap time of the current track, lap time remaining of the current track, lap time remaining of all tracks.
 - For MP3 disc and USB: ID3 information, such as **[TITLE]** (title), **[ALBUM]** (album), **[ARTIST]** (artist).

Select repeat/shuffle play options

- 1 During play, press **MODE** repeatedly to select a repeat option or the shuffle play mode.
 - **REP**: the current track is played repeatedly.

- **REP ALL:** all tracks are played repeatedly.
- **REP ALB:** all tracks in the album are played repeatedly.
- **SHUF:** all tracks are played randomly.

2 To resume normal play, press **MODE** repeatedly until no option is displayed.

Play from USB

Note

- Make sure that the USB device contains playable audio content.

1 Insert the USB mass storage device into the  socket.

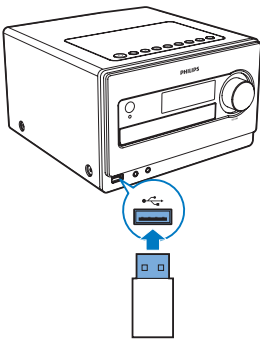

2 Press **SOURCE** repeatedly to select the USB source.

↳ Play starts automatically. If not, press



- To select a folder, press **PRESET/ALBUM ▲ / ▼**.
- To select an audio file, press **◀◀ / ▶▶**.

Note

- You can press numeric keypad directly to select a file from the current folder.

Play from a Bluetooth device

You can listen to a Bluetooth device through the unit.

Note

- Before you connect a Bluetooth device to the unit, familiarize yourself with the Bluetooth capabilities of the device.
- Keep the unit away from other electronic devices that may cause interference.
- The effective operation range between the unit and the paired device is approximately 10 meters (30 feet).
- Any obstacle between the unit and the device can reduce the operational range.

1 Press **SOURCE** repeatedly to select Bluetooth source.

2 Activate the Bluetooth function on your Bluetooth device (see the device user manual).

3 Select "BTM5000" on your device for pairing.

↳ The Bluetooth indicator lights up.

↳ **[CONNECT]** displays on the screen.

- For some devices, you may need to input "0000" as the pairing password.

4 Start music play on your Bluetooth device.

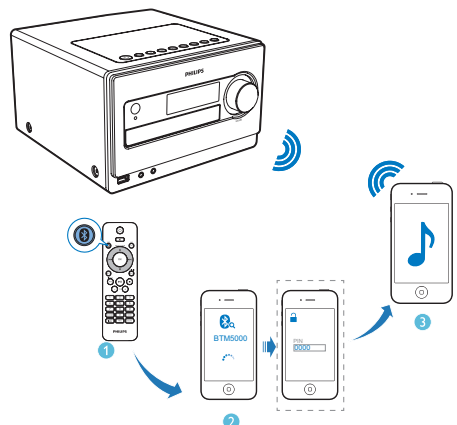

 Tip

- If the unit switches from Bluetooth source to other sources, the connected Bluetooth device disconnects automatically.
- The system can memorize up to 8 previously connected Bluetooth devices.



To clear Bluetooth pairing history:

Press and hold .



- ↳ The current Bluetooth connection is disconnected.
- ↳ After successful clearing, **[CLEAR BLUETOOTH PAIRED LIST SUCCESSFULLY]** (Clear Bluetooth paired list successfully) scrolls on the screen.

5 Listen to radio

Tune to a radio station

- 1 Press **SOURCE** repeatedly to select the tuner source.
- 2 Press and hold  /  for more than 2 seconds.
 - ↳ **[SEARCH]** (search) is displayed.
 - ↳ The radio tunes to a station with strong reception automatically.
- 3 Repeat step 2 to tune to more stations.

 Tip

- To tune to a weak station, press  /  repeatedly until you find optimal reception.

Program radio stations automatically

You can program a maximum of 20 preset radio stations (FM).

- In tuner mode, press and hold **PROG** for more than 2 seconds to activate automatic program mode.
 - ↳ **[AUTO]** (auto) is displayed.
 - ↳ All available stations are programmed in the order of waveband reception strength.
 - ↳ The first programmed radio station is broadcast automatically.

Program radio stations manually

You can program a maximum of 20 preset radio stations (FM).

- 1 Tune to a radio station.
- 2 Press **PROG** to activate program mode.
↳ **[PRG]** (program) is displayed.
- 3 Press **PRESET/ALBUM ▲ / ▼** to allocate a number to this radio station, then press **PROG** to confirm.
- 4 Repeat the above steps to program other stations.



Tip

- To overwrite a programmed station, store another station in its place.

Select a preset radio station

- In tuner mode, press **PRESET/ALBUM ▲ / ▼** to select a preset number.
- You can also press the numeric keypad to select a preset number directly.



Tip

- Position the antenna as far as possible from TV, VCR, or other radiation source.
- For optimal reception, fully extend and adjust the position of the antenna.

Select stereo/mono broadcast

For stations with weak signals: to improve the reception, change to monaural sound.

- In tuner source, press **OK** to select a setting:
 - **[STEREO]**: stereo broadcast.
 - **[MONO]**: monaural broadcast.

Show RDS information

RDS (Radio Data System) is a service that allows FM stations to show additional information. If you tune to an RDS station, an RDS icon and the station name are displayed.

- 1 Tune to an RDS station.
- 2 Press **RDS/DISPLAY** repeatedly to scroll through the following information (if available):
 - ↳ Station name
 - ↳ Program type such as **[NEWS]** (news), **[SPORT]** (sport), **[POP M]** (pop music)...
 - ↳ RDS RT
 - ↳ Frequency

Synchronize clock with RDS

You can synchronize time shown on the unit with that on the RDS station.

- 1 Tune to a RDS radio station that transmits time signals.
- 2 Press **RDS/DISPLAY** for over 2 seconds.
 - ↳ **[CT SYNC]** is displayed and the unit reads RDS time automatically.
 - ↳ If no time signal is received, **[NO CT]** is displayed.



Note

- The accuracy of the transmitted time depends on the RDS station that transmits the time signal.

6 Adjust sound

Adjust volume

- During play, press **VOL +/-** to increase/decrease the volume.

Select a preset sound effect

- During play, press **SOUND** repeatedly to select:
 - **[WARM]** (warm)
 - **[BRIGHT]** (bright)
 - **[POWERFUL]** (powerful)
 - **[CLEAR]** (clear)
 - **[BALANCED]** (balanced)

Mute sound

- During play, press **M** to mute/unmute sound.
 - ↳ **[MUTING]** (muting) blinks on the display after muting sound.

7 Other features

Set the sleep timer

This unit can switch to standby automatically after a set period of time.

- When the unit is turned on, press **SLEEP/TIMER** repeatedly to select a set period of time (in minutes).
 - **[SLEEP OFF]**
 - **[SLEEP -- 120]**
 - **[SLEEP -- 90]**
 - **[SLEEP -- 60]**
 - **[SLEEP -- 45]**
 - **[SLEEP -- 30]**
 - **[SLEEP -- 15]**
- ↳ When sleep timer is activated, **zZ** is displayed.

To deactivate sleep timer

- Press **SLEEP/TIMER** repeatedly until **[SLEEP OFF]** (sleep off) is displayed.
 - ↳ When sleep timer is deactivated, **zZ** disappears.

Set the alarm timer

This unit can be used as an alarm clock. The **DISC**, **TUNER** or **USB** is activated to play at a preset time.



- 1 Press **⏻** to switch the unit to standby mode.
- 2 Make sure that you have set the clock correctly.
- 3 Press and hold **SLEEP/TIMER**.
 - ↳ A prompt to select the source is displayed.
- 4 Press **SOURCE** repeatedly to select a source: **DISC**, **USB** or **TUNER**.

- 5 Press **SLEEP/TIMER** to confirm.
↳ The hour digits begin to blink.
- 6 Press **PRESET/ALBUM ▲ / ▼** to set the hour.
- 7 Press **SLEEP/TIMER** to confirm.
↳ The minute digits begin to blink.
- 8 Press **PRESET/ALBUM ▲ / ▼** to set the minute.
- 9 Press **SLEEP/TIMER** to confirm.
↳ The [VOL] (volume) begins to blink.
- 10 Press **PRESET/ALBUM ▲ / ▼** to adjust the volume, then press **SLEEP/TIMER** to confirm.
↳ The timer is set and activated.

Tip

- For source selection, you can also press **VOL -/+**, **PRESET/ALBUM ▲ / ▼** on the remote control, or **◀ / ▶**, **VOLUME** on the main unit.
- For hour/minute/volume adjustment, you can also press **VOL -/+** on the remote control, or **◀ / ▶**, **VOLUME** on the main unit.

Activate and deactivate the alarm timer

- 1 Press **⏻** to switch the unit to standby mode.
- 2 Press **SLEEP/TIMER** repeatedly to activate or deactivate the timer:
 - ↳ If the timer is activated, the display shows .
 - ↳ If the timer is deactivated,  disappears on the display.

Note

- In audio in and Bluetooth mode, the alarm timer cannot be set.
- If DISC/USB source is selected and the track cannot be played, tuner is activated automatically.

Play from external audio device

You can play from an external audio device such as MP3 player through this unit.

- 1 Connect the audio device.
 - For audio device with red/white audio output sockets:
Connect a red/white audio cable (not supplied) to the **AUX-IN** sockets and to the audio output sockets on the audio device.
 - For audio device with headphone sockets:
Connect the audio in cable (not supplied) to the **AUDIO IN** socket and to the headphone socket on the audio device.
- 2 Press **SOURCE** to select **AUDIO IN** or **AUX** source.
- 3 Play the external audio device.

Adjust display brightness

Note

- You can adjust the display brightness in standby mode only.

In standby mode, press **RDS/DISPLAY** repeatedly to adjust display brightness.

- Full brightness (100%)
- Half brightness (70%)
- Brightness low (40%)

Headphone

Plug headphones (not supplied) into the  socket on the unit to listen through the headphones.

8 Product information

Note

- Product information is subject to change without prior notice.

Specifications

Amplifier

Rated Output Power	2 × 20 W RMS
Frequency Response	40 Hz - 20 kHz, ± 3 dB
Signal to Noise Ratio	> 77 dBA
Audio in Input	600mV RMS 22k Ω
Aux Input	1000mV RMS 22k Ω

Disc

Laser Type	Semiconductor
Disc Diameter	12 cm /8 cm
Support disc	CD-DA, CD-R, CD-RW, MP3-CD, WMA-CD
Audio DAC	24 Bits / 44.1 kHz
Total Harmonic Distortion	< 0.8% (1 kHz)
Frequency Response	40 Hz -20 kHz (44.1 kHz)
Signal to Noise Ratio	> 77 dBA

Tuner

Tuning Range	FM: 87.5 - 108 MHz
Tuning grid	50 KHz
Number of presets	20

Sensitivity	
- Mono, 26dB S/N Ratio	< 22 dBf
- Stereo, 46dB S/N Ratio	< 43 dBf
Search Selectivity	< 28 dBf
Total Harmonic Distortion	< 3%
Signal to Noise Ratio	>= 50 dB

Speakers

Speaker Impedance	6 ohm
Speaker Driver	89 mm woofer + 13 mm tweeter
Sensitivity	>85dB/m/W ±4dB/m/W

General information

AC power	220V - 240V ~ , 50/60Hz
Operation Power Consumption	25 W
Eco Standby Power Consumption	< 0.5 W
USB Direct	Version 2.0HS
Dimensions	
- Main Unit (W × H × D)	210 × 132 × 242 mm
- Speaker	200 × 132 × 220 mm
Weight	1.8 kg
- Main Unit	1.6 kg × 2
- Speaker	

USB playability information

Compatible USB devices:

- USB flash memory (USB 1.1 and USB 2.0)
- USB flash players (USB 1.1 and USB 2.0)
- memory cards (requires an additional card reader to work with this unit)

Supported formats:

- USB or memory file format FAT12, FAT16, FAT32 (sector size: 512 bytes)
- MP3 bit rate (data rate): 32-320 Kbps and variable bit rate
- WMA v9 or earlier
- Directory nesting up to a maximum of 8 levels
- Number of albums/ folders: maximum 99
- Number of tracks/titles: maximum 999
- ID3 tag v2.0 to v2.3
- File name in Unicode UTF8 (maximum length: 16 bytes)

Supported MP3 disc formats

- ISO9660, Joliet
- Maximum title number: 999 (depending on file name length)
- Maximum album number: 99
- Supported sampling frequencies: 32 kHz, 44.1 kHz, 48 kHz
- Supported Bit-rates: 32~320 (kbps), variable bit rates

Bluetooth

Standard	Bluetooth Standard Version 2.1+EDR
Frequency band	2.402~2.480 GHz ISM Band
Range	10m (free space)

Maintenance

Clean the cabinet

- Use a soft cloth slightly moistened with a mild detergent solution. Do not use a solution containing alcohol, spirits, ammonia or abrasives.

Clean discs

- When a disc becomes dirty, clean it with a cleaning cloth. Wipe the disc from the centre out.



- Do not use solvents such as benzene, thinner, commercially available cleaners, or antistatic spray intended for analogue records.

Clean the disc lens

- After prolonged use, dirt or dust may accumulate at the disc lens. To ensure good play quality, clean the disc lens with Philips CD lens cleaner or any commercially available cleaner. Follow the instructions supplied with cleaner.

9 Troubleshooting



Warning

- Never remove the casing of this apparatus.

To keep the warranty valid, never try to repair the system yourself.

If you encounter problems when using this unit, check the following points before requesting service. If the problem remains unsolved, go to the Philips web site (www.philips.com/support). When you contact Philips, ensure that the unit is nearby and the model number and serial number are available.

No power

- Ensure that the AC power cord of the unit is connected properly.
- Ensure that there is power at the AC outlet.
- As a power-saving feature, the system switches off automatically 15 minutes after track play reaches the end and no control is operated.

No sound or poor sound

- Adjust the volume.
- Disconnect the headphones.
- Check that the speakers are connected correctly.
- Check if the stripped speaker wires are clamped.

No response from the unit

- Disconnect and reconnect the AC power plug, then turn on the unit again.
- As a power-saving feature, the system switches off automatically 15 minutes after track play reaches the end and no control is operated.

Remote control does not work

- Before you press any function button, first select the correct source with the remote control instead of the main unit.

- Reduce the distance between the remote control and the unit.
- Insert the batteries with its polarities (+/- signs) aligned as indicated.
- Replace the batteries.
- Aim the remote control directly at the sensor on the front of the unit.

No disc detected

- Insert a disc.
- Check if the disc is inserted upside down.
- Wait until the moisture condensation at the lens has cleared.
- Replace or clean the disc.
- Use a finalized CD or correct format disc.

Cannot display some files in USB device

- The number of folders or files in the USB device has exceeded a certain limit. This phenomenon is not a malfunction.
- The formats of these files are not supported.

USB device not supported

- The USB device is incompatible with the unit. Try another one.

Poor radio reception

- Increase the distance between the unit and your TV or VCR.
- Fully extend the FM antenna.
- Connect an outdoor FM antenna instead.

Timer does not work

- Set the clock correctly.
- Switch on the timer.

Clock/timer setting erased

- Power has been interrupted or the power cord has been disconnected.
- Reset the clock/timer.

Music playback unavailable after successful connection

- The Bluetooth-enabled device is incompatible with the unit.

Bluetooth-enabled device connection error

- The device does not support the profiles required for the unit.
- The unit already connected with another Bluetooth-enabled device. Disconnect that device or all other connected devices and then try again.

The paired mobile phone connects and disconnects constantly

- The Bluetooth reception is poor. Move the mobile phone closer to the unit or remove any obstacle between the mobile phone and the unit.
- Some mobile phones may connect and disconnect constantly when you make or end calls. This does not indicate any malfunction of the unit.
- For some mobile phones, the Bluetooth connection may be deactivated automatically as a power-saving feature. This does not indicate any malfunction of the unit.



Specifications are subject to change without notice
© 2013 Koninklijke Philips Electronics N.V.
All rights reserved.

BTM5000_12_UM_V1.0

