

# Quick start guide

**PHILIPS**

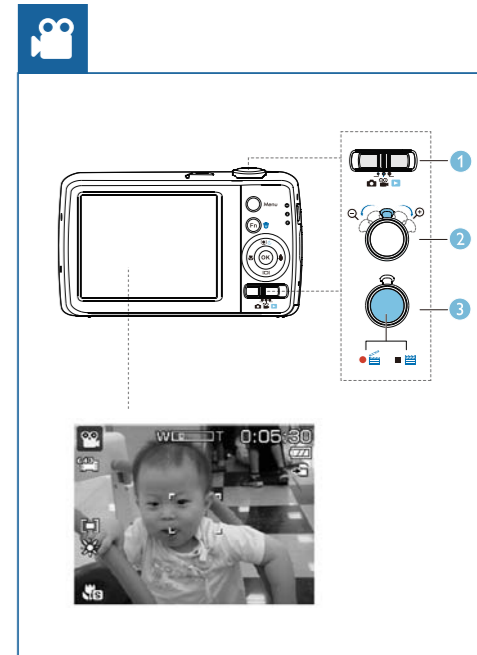

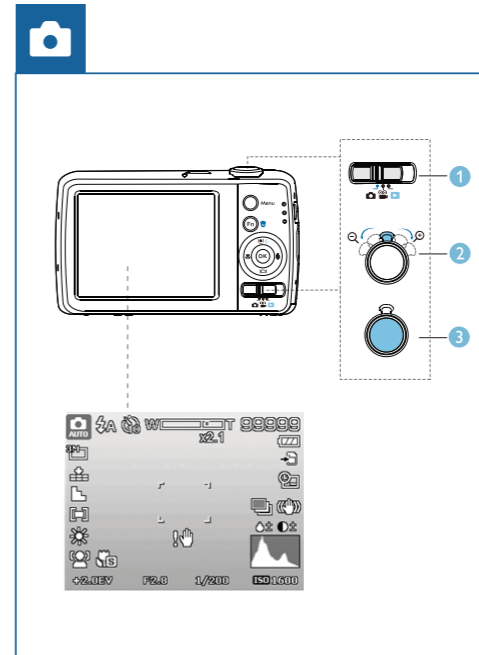
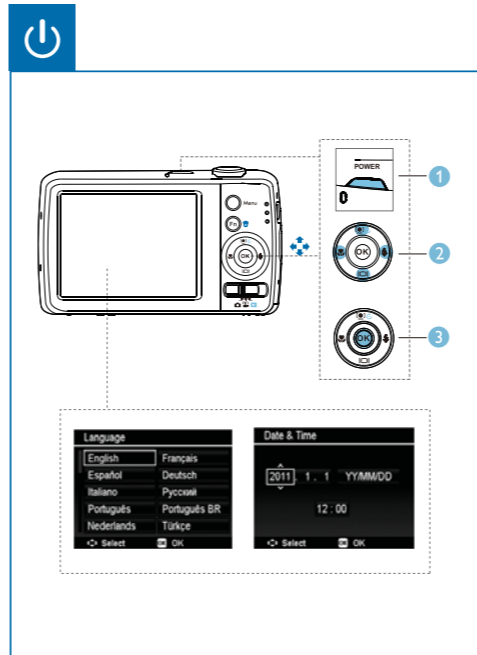
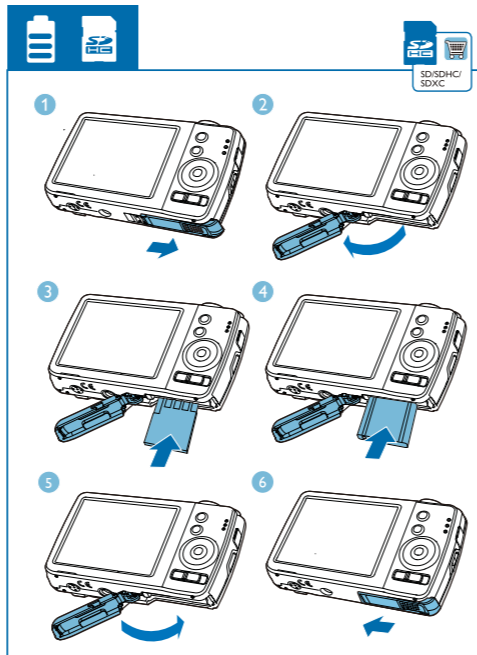
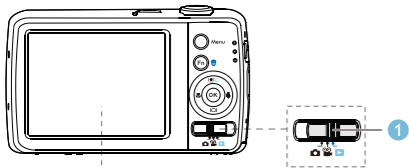

2

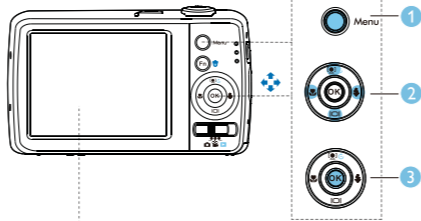
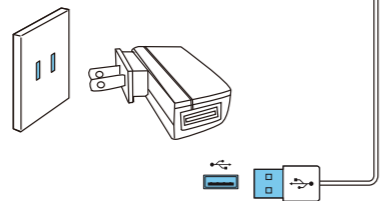

# Important

## Safety

- ① Read these instructions.
- ② Keep these instructions.
- ③ Heed all warnings.
- ④ Follow all instructions.
- ⑤ Do not use this apparatus near water.
- ⑥ Clean only with dry cloth.
- ⑦ Do not block any ventilation openings. Install in accordance with the manufacturer's instructions.
- ⑧ Do not install near any heat sources such as radiators, heat registers, stoves, or other apparatus (including amplifiers) that produce heat.
- ⑨ Only use attachments/accessories specified by the manufacturer.
- ⑩ Refer all servicing to qualified service personnel. Servicing is required when the apparatus has been damaged in any way, such as power-supply cord or plug is damaged, liquid has been spilled or objects have fallen into the apparatus, the apparatus has been exposed to rain or moisture, does not operate normally, or has been dropped.
- ⑪ **Battery usage CAUTION**

- To prevent battery leakage which may result in bodily injury, property damage, or damage to the unit:
  - Install all batteries correctly, + and - as marked on the unit.
  - Do not mix batteries (old and new or carbon and alkaline, etc.).
  - Remove batteries when the unit is not used for a long time.

- Danger of explosion if the battery is incorrectly replaced. Replace only with the same or equivalent type.
- ⑫ Apparatus shall not be exposed to dripping or splashing.
- ⑬ Do not place any sources of danger on the apparatus (e.g. liquid filled objects, lighted candles).

## Notice

### Disposal of your old product and batteries

Your product is designed and manufactured with high quality materials and components, which can be recycled and reused. Never dispose of your product with other household waste. Please inform yourself about the local rules on the separate collection of electrical and electronic products and batteries. The correct disposal of these products helps prevent potentially negative consequences on the environment and human health. Please visit for additional information on a recycling center in your area.

### Caution

- Removal of the built-in battery invalidates the warranty and may destroy the product.

### Note

- You can find the safety logo and power rating information at the bottom of the unit.



All registered and unregistered trademarks are property of their respective owners.  
© 2012 Koninklijke Philips Electronics N.V.  
All rights reserved.

