

DVD VIDEO PLAYER

DVP640 • DVP642



Need help? Call us!

Philips representatives are ready to help you with any questions about your new product. We can guide you through Connections, First-time Setup, or any of the Features. We want you to start enjoying your new product right away!

CALL US BEFORE YOU CONSIDER RETURNING THE PRODUCT!

1-800-531-0039

or

Visit us on the web at www.philips.com



PHILIPS

Return your Warranty Registration card today to ensure you receive all the benefits you're entitled to.

- Once your Philips purchase is registered, you're eligible to receive all the privileges of owning a Philips product.
- So complete and return the Warranty Registration Card enclosed with your purchase at once, and take advantage of these important benefits.

Warranty Verification

Registering your product within 10 days confirms your right to maximum protection under the terms and conditions of your Philips warranty.

Owner Confirmation

Your completed Warranty Registration Card serves as verification of ownership in the event of product theft or loss.

Model Registration

Returning your Warranty Registration Card right away guarantees you'll receive all the information and special offers which you qualify for as the owner of your model.

Know these
safety symbols



 This “bolt of lightning” indicates uninsulated material within your unit may cause an electrical shock. For the safety of everyone in your household, please do not remove product covering.

 The “exclamation point” calls attention to features for which you should read the enclosed literature closely to prevent operating and maintenance problems.

For Customer Use

Enter below the Serial No. which is located on the rear or bottom of the cabinet. Retain this information for future reference.

Model No. _____

Serial No. _____

WARNING: TO PREVENT FIRE OR SHOCK HAZARD, DO NOT EXPOSE THIS EQUIPMENT TO RAIN OR MOISTURE.

CAUTION: To prevent electric shock, match wide blade of plug to wide slot, and fully insert.



PHILIPS

***Congratulations on your purchase,
and welcome to the “family!”***

Dear Philips product owner:

Thank you for your confidence in Philips. You've selected one of the best-built, best-backed products available today. And we'll do everything in our power to keep you happy with your purchase for many years to come.

As a member of the Philips “family,” you're entitled to protection by one of the most comprehensive warranties and outstanding service networks in the industry.

What's more, your purchase guarantees you'll receive all the information and special offers for which you qualify, plus easy access to accessories from our convenient home shopping network.

And most importantly you can count on our uncompromising commitment to your total satisfaction.

All of this is our way of saying welcome – and thanks for investing in a Philips product.

Sincerely,

Lawrence J. Blanford
President and Chief Executive Officer

P.S. Remember, to get the most from your Philips product, you must return your Warranty Registration Card within 10 days. So please mail it to us right now!

IMPORTANT SAFETY INSTRUCTIONS

1. Read these instructions.
2. Keep these instructions.
3. Heed all warnings.
4. Follow all instructions.
5. Do not use this apparatus near water.
6. Clean only with dry cloth.
7. Do not block any ventilation openings. Install in accordance with the manufacturer's instructions.
8. Do not install near any heat sources such as radiators, heat registers, stoves, or other apparatus (including amplifiers) that produce heat.

9. Do not defeat the safety purpose of the polarized or grounding-type plug.

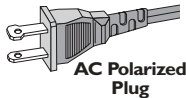

A polarized plug has two blades with one wider than the other: A grounding type plug has two blades and a third grounding prong. The wide blade or the third prong are provided for your safety. If the provided plug does not fit into your outlet, consult an electrician for replacement of the obsolete outlet.

10. Protect the power cord from being walked on or pinched, particularly at plugs, convenience receptacles, and the point where they exit from the apparatus.
11. Only use attachments/accessories specified by the manufacturer.

12.  Use only with the cart, stand, tripod, bracket, or table specified by the manufacturer or sold with the apparatus. When a cart is used, use caution when moving the cart/apparatus combination to avoid injury from tip-over.

13. Unplug this apparatus during lightning storms or when unused for long periods of time.

14. Refer all servicing to qualified service personnel. Servicing is required when the apparatus has been damaged in any way, such as power-supply cord or plug is damaged, liquid has been spilled or objects have fallen into the apparatus, the apparatus has been exposed to rain or moisture, does not operate normally, or has been dropped.

15. Battery usage **CAUTION** – To prevent battery leakage which may result in bodily injury, property damage, or damage to the unit:

- Install **all** batteries correctly, + and - as marked on the unit.
- Do not mix batteries (**old** and **new** or **carbon** and **alkaline**, etc.).
- Remove batteries when the unit is not used for a long time.

16. Apparatus shall not be exposed to dripping or splashing.

17. Do not place any sources of danger on the apparatus (e.g. liquid filled objects, lighted candles).

Class II equipment symbol



This symbol indicates that the unit has a double insulation system

Canada

English:

This digital apparatus does not exceed the Class B limits for radio noise emissions from digital apparatus as set out in the Radio Interference Regulations of the Canadian Department of Communications.

Français:

Cet appareil numérique n'émet pas de bruits radioélectriques dépassant les limites applicables aux appareils numériques de Class B prescrites dans le Règlement sur le Brouillage Radioélectrique édicté par le Ministère des Communications du Canada.

ATTENTION

L'utilisation des commandes ou réglages ou le non-respect des procédures ci-inclues peuvent se traduire par une exposition dangereuse à l'irradiation.

ATENCIÓN

El uso de mando o ajustes o la ejecución de métodos que no sean los aquí descritos puede ocasionar peligro de exposición a radiación.

This warning label is located on the rear panel and inside this laser product.

CAUTION: INVISIBLE LASER RADIATION WHEN OPEN. DO NOT STARE INTO BEAM.
DANGER: INVISIBLE LASER RADIATION WHEN OPEN. AVOID DIRECT EXPOSURE TO BEAM.
VARO! AVATTAESSA JA SUOJALUKITUS OHITETTAESSA OLET ALTTIINANAKYMATTOMAAALLE LASERSATEILYLLE. ÄLÄ KATSO SATEESEEN.
WARNING! OSYNLIG LASERSTRÅLNING NÄR DENNA DEL ÄR ÖPPNAD. OCH SPÄRREN ÄR URKOPPLAD. BETRÄKTA EJ STRÅLEN.

or

DANGER - Invisible laser radiation when open. AVOID DIRECT EXPOSURE TO BEAM.

WARNING

To reduce the risk of fire or electric shock, do not expose this appliance to rain or moisture.

Use of controls or adjustments or performance of procedures other than herein may result in hazardous radiation exposure.

The set complies with the FCC-Rules, Part 15 and with 21 CFR 1040.10.

Important Note:

Due to the numerous versions of new CD-Audio copy protection or enhanced CD-Audio protection recently available on certain discs, Philips is unable to guarantee that this DVD Player is fully compatible with such new discs. Should you have difficulty playing any such CD-Audio discs, kindly refer them to your CD-Audio disc retailer.

General Information

Environmental Information

All unnecessary packaging has been omitted. The packaging has been made easy to separate into three materials: cardboard (box), polystyrene foam (buffer) and polyethylene (bags, protective foam sheet).

Your DVD player consists of materials which can be recycled and reused if disassembled by a specialized company. Please observe the local regulations regarding the disposal of packaging materials, exhausted batteries and old equipment.

DivX, DivX Certified, and associated logos are trademarks of DivX Networks, Inc and are used under license.



This product incorporates copyright protection technology that is protected by method claims of certain U.S. patents and other intellectual property rights owned by Macrovision Corporation and other rights owners. Use of this copyright protection technology must be authorized by Macrovision Corporation, and is intended for home and other limited viewing uses only unless otherwise authorized by Macrovision Corporation. Reverse engineering or disassembly is prohibited.

Laser safety

This unit employs a laser. Due to possible eye injury, only a qualified service person should remove the cover or attempt to service this device.

**NOTE:
PICTURES SHOWN MAY BE DIFFERENT BETWEEN COUNTRIES.**

**CAUTION
(WARNING LOCATION: ON THE BACKPLATE OF THE SET)**

NEVER MAKE OR CHANGE CONNECTIONS WITH THE POWER SWITCHED ON.

Manufactured under license from Dolby Laboratories. "Dolby", "Pro-Logic" and the double-D symbol are trademarks of Dolby Laboratories.

For Customer Use:

Read carefully the information located at the rear of your DVD Player and enter below the Serial No. Retain this information for future reference.

Model No. DVD 640 / DVD 642
Serial No. _____

LASER

Type	Semiconductor laser GaAlAs
Wave length	650 nm (DVD) 780 nm (VCD/CD)
Output Power	7 mW (DVD) 10 mW (VCD/CD)
Beam divergence	60 degree

General Information

Supplied accessories	8
Care and safety information	8

Connections

Connecting TV	9-11
Using Composite Video jack (CVBS)	9
Using S-Video jack	9
Using Component Video jacks (Pr Pb Y) .	10
Using an accessory RF modulator	10-11
Connecting the power cord	11
Optional : Connecting to an Audio System .	12
Stereo has Dolby Pro Logic or Right / Left	
Audio In jacks	12
Optional: Connecting to a Digital Receiver ..	12
Receiver has a PCM, Dolby Digital, or	
MPEG2 decoder	12

Functional Overview

Front and Rear Panels	13
Remote Control	14

Getting Started

Step 1: Inserting batteries into the	
Remote Control	15
Using the Remote Control to operate the	
Player	15
Step 2: Setting up the TV	15-16
Deactivate Progressive manually	15-16
Selecting the color system that corresponds	
to your TV	16
Step 3: Setting language preferences	17
Setting the OSD Language	17
Setting the Audio, Subtitle and Disc menu	
languages	17

Disc Operations

Playable Discs	18
Region Codes	18
Playing discs	19
Using the Disc Menu	19
Basic playback controls	19-21
Pausing playback	19
Selecting track/chapter	19
Mute	20
Resuming playback from the last stopped	
point	20
Zoom	20
Repeat	20
Repeat A-B	20
Display	21
Slow Motion	21
Searching	21
Program playback	21

Special DVD features	22
Playing a Title	22
Camera Angle	22
Changing the Audio Language	22
Subtitles	22
Special VCD & SVCD Features	22-23
Playback Control (PBC)	22
Preview	23
Playing MP3/DivX/MPEG-4/JPEG/Kodak	
Picture CD	24
General Operation	24
Playback selection	24
Special MP3/JPEG features	24
Preview Function (JPEG)	24
Zoom picture (JPEG)	24
Playback with multi-angles (JPEG)	24
Scan Effect (JPEG)	24
Playback speed control (MP3)	24

DVD Menu Options

Basic Operations	25
General Setup menu	25-26
Screen Saver	25
Smart Power	25
Disc Lock	26
Program	26
Audio Setup Menu	27-28
DOWNMIX	27
Digital Output	27
LPCM Output	27
Sound Mode	28
Reverb Mode	28
D.R.C. (Dynamic Range Control)	28
Video Setup Menu	29-31
TV Display	29
Closed Captions	29
Video Output	30
Progressive	30
Smart Picture	31
Preferences Menu	31-32
Parental	31-32
Password	32
Default	33
MP3/JPEG Navigator	33

Specifications

Troubleshooting

Glossary

.....	37
-------	----

General Information

Supplied accessories

Video cable
(yellow)



Audio cable
(white, red)



Remote Control
and
two AA batteries

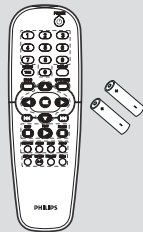

Care and safety information

- **Power consumption**
 - When the system is switched to Standby mode, it is still consuming power. To disconnect the system from the power supply completely, remove the AC power plug from the wall jack.

- **Avoid high temperatures, moisture, water and dust**
 - Do not expose the player, batteries or discs to humidity, rain, sand or excessive heat (caused by heating equipment or direct sunlight).
- **Avoid condensation**
 - The lens may cloud over when the player is suddenly moved from cold to warm surroundings, making it impossible to play a disc. Leave the player in the warm environment until the moisture evaporates.
- **Do not block the vents**
 - Do not operate the DVD Player in an enclosed cabinet. Allow about 10 cm (4 inches) of free space around the player for adequate ventilation.

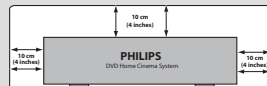

- **Care of the cabinet**
 - Use a soft cloth slightly moistened with a mild detergent solution. Do not use a solution containing alcohol, spirits, ammonia or abrasives.
- **Finding a suitable location**
 - Place the player on a flat, hard, and stable surface.
- **Disc handling**
 - To clean a CD, wipe it in a straight line from the center toward the edge using a soft, lint-free cloth. A cleaning agent may damage the disc.
 - Write only on the printed side of a CD-R/CD-RW and only with a soft felt-tipped pen.
 - Handle the disc by its edge; do not touch the surface.

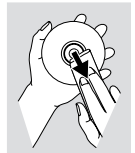

Connecting TV

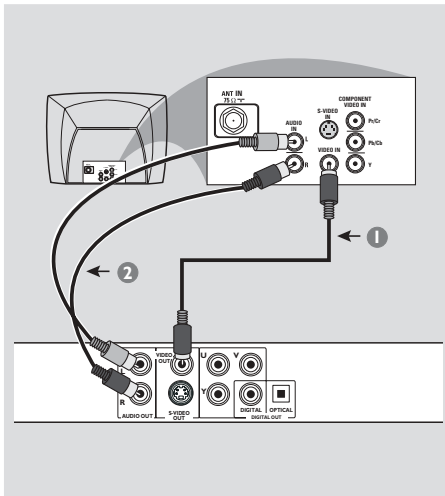

IMPORTANT!

- You only need to make one video connection from the following options, depending on the capabilities of your TV.
- Connect the DVD Player directly to the TV.

Using Composite Video jack (CVBS)

- 1 Use the supplied composite video cable (yellow) to connect the DVD Player's **yellow VIDEO OUT (CVBS) jack** to the VIDEO IN jack (labeled as Video In, Composite, CVBS, or Baseband) on the TV.
- 2 To hear the sound of this DVD Player through your TV, use the audio cables (white/red) to connect AUDIO OUT (L/R) jacks of the DVD Player to the corresponding AUDIO IN jacks on the TV (cable supplied).

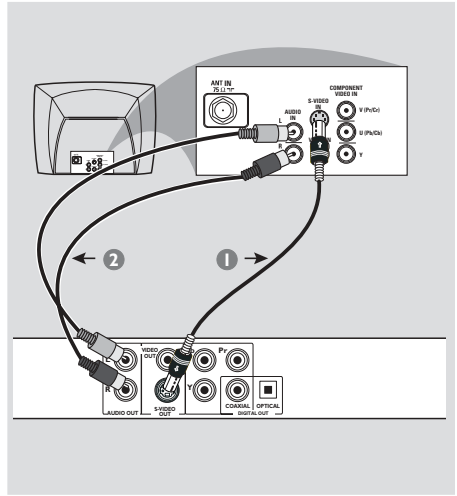

IMPORTANT!

- S-Video provides better picture quality. This option must be available on your TV.

Using S-Video jack

- 1 Use the S-video cable to connect the DVD Player's **S-VIDEO OUT** jack to the S-Video in jack (labeled as Y/C or S-VHS) on the TV (cable not supplied).
- 2 To hear the sound of this DVD Player through your TV, use the audio cables (white/red) to connect AUDIO OUT (L/R) jacks of the DVD Player to the corresponding AUDIO IN jacks on the TV (cable supplied).

Connections

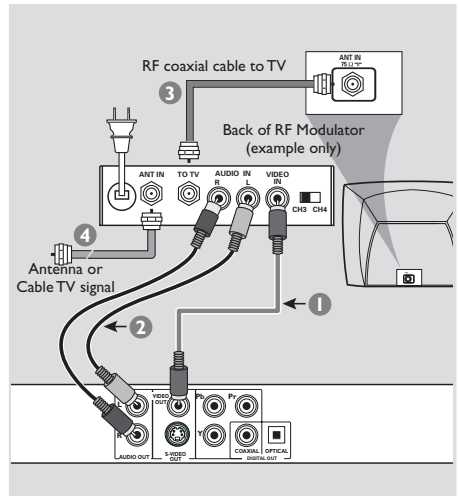
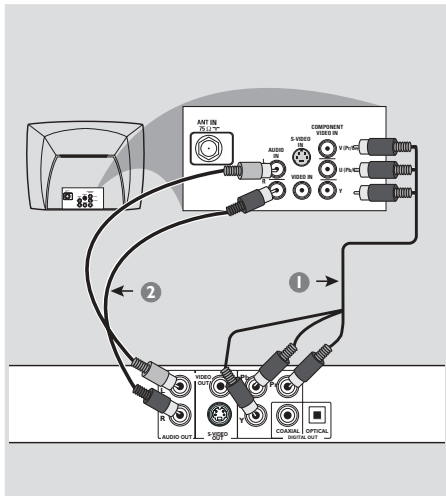

IMPORTANT!

- **Component Video** provides higher picture quality. This option must be available on your TV.
- **Progressive Scan video quality** is only possible when using **Component Video (Pr Pb Y)**.

Using Component Video jacks (Pr Pb Y)

- 1 Use the component video cables (red/blue/green) to connect the DVD Player's **Pr Pb Y** jacks to the corresponding Component video in jacks (labeled as Pr/Cr Pb/Cb Y or YUV) on the TV (*cable not supplied*).
- 2 To hear the sound of this DVD Player through your TV, use the audio cables (white/red) to connect AUDIO OUT (L/R) jacks of the DVD Player to the corresponding AUDIO IN jacks on the TV (*cable supplied*).

IMPORTANT!

- If your TV only has a single **Antenna In** jack (labeled as 75 ohm or RF In), you will need an **RF modulator** in order to view DVD playback on the TV. The RF modulator is not supplied with the DVD Player. See your electronics retailer or contact Philips for details on RF modulator availability and operations.

Using an accessory RF modulator

- 1 Use the supplied composite video cable (yellow) to connect the DVD Player's **yellow VIDEO OUT (CVBS)** jack to the video in jack on the RF modulator.
- 2 Use the supplied audio cable (white/red) to connect the DVD Player's AUDIO OUT (L/R) jacks to the AUDIO jacks on the TV.

Connecting the power cord

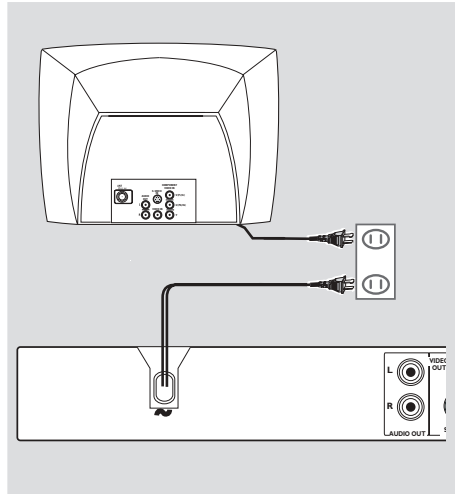

Using an accessory RF modulator (cont'd)

- 3 Use an RF coaxial cable (not supplied) to connect ANTENNA OUT or TO TV jack of the RF modulator to the ANTENNA IN jack on the TV.
- 4 Connect the Antenna or Cable TV service signal to the ANTENNA IN or RF IN jack on the RF modulator. (It may have been connected to your TV previously. Disconnect it from the TV).
- 5 Set the CH3/4 switch on the RF modulator to 3 or 4. Set your TV to the same channel.

After everything is connected properly, plug the AC power cord into the power outlet.

Never make or change any connections with the power switched on.

When no disc is loaded, **press STANDBY ON on the DVD Player to turn it on.**

"NO DISC" may appear on the display panel.

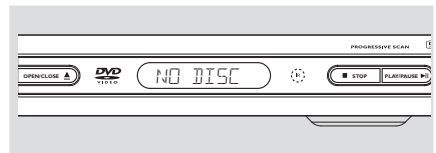

Connections

Optional: Connecting to an Audio System

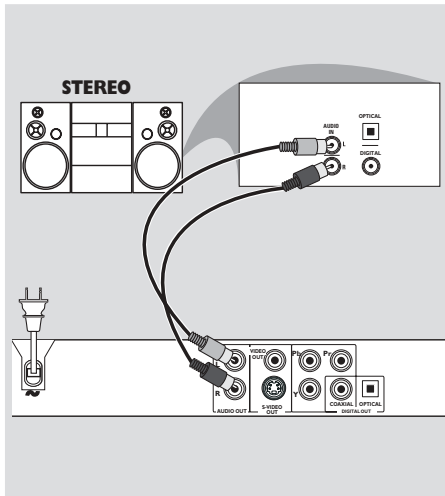

Optional: Connecting to a Digital Receiver

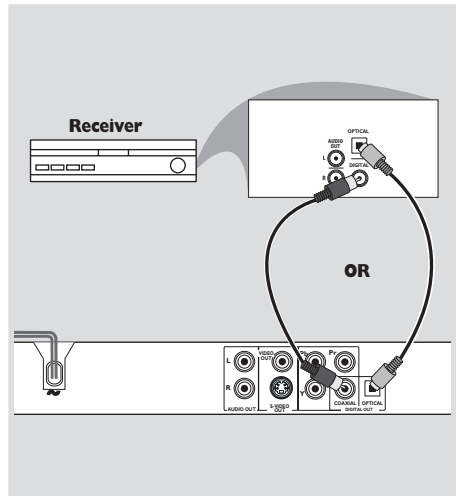

Stereo has Dolby Pro Logic or Right / Left Audio In jacks

- 1 Select one of the video connections to your TV (CVBS VIDEO IN, S-VIDEO IN, or COMPONENT VIDEO IN) depending on the options available on your TV.
- 2 Use the audio cables (white/red) to connect **AUDIO OUT (L/R)** jacks of the DVD Player to the corresponding **AUDIO IN** jacks on the stereo (*cable supplied*).

Receiver has a PCM, Dolby Digital, or MPEG2 decoder

- 1 Select one of the video connections to your TV (CVBS VIDEO IN, S-VIDEO IN, or COMPONENT VIDEO IN) depending on the options available on your TV.
- 2 Connect either the **COAXIAL** or **OPTICAL** jack of the DVD Player to the corresponding **Digital Audio In** jack on your Receiver (*cable not supplied*).
- 3 Set the DVD Player's **Digital Output** to **PCM-ONLY** or **ALL** depending on the capabilities of your Receiver (see page 27 "Digital Output").

Helpful Hint:

- If the audio format of **Digital Output** does not match the capabilities of your receiver, the receiver will produce a strong, distorted sound or no sound at all.

Functional Overview

Front and Rear Panels

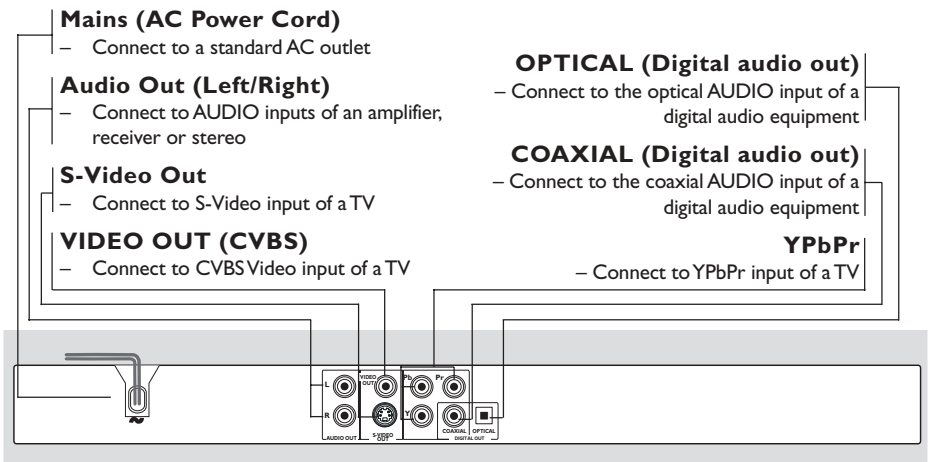
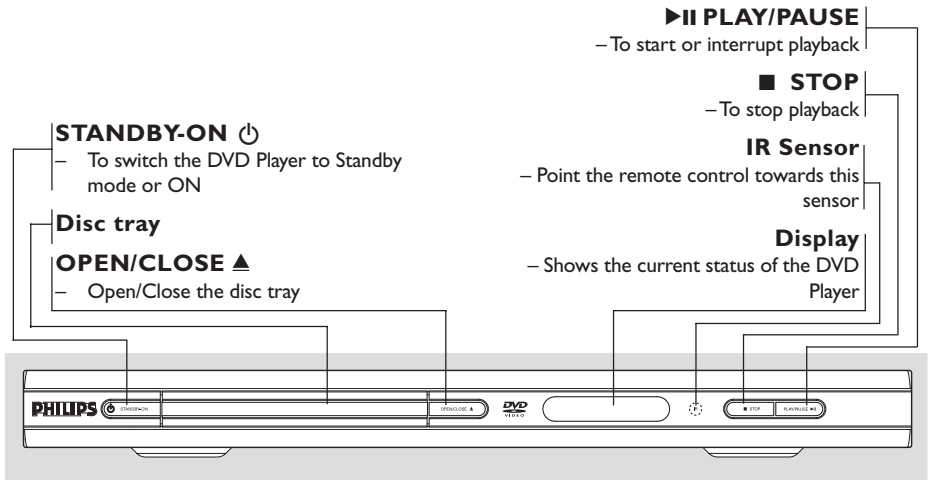

Caution: Do not touch the inner pins of the jacks on the rear panel. Electrostatic discharge may cause permanent damage to the unit.

Functional Overview

Remote Control

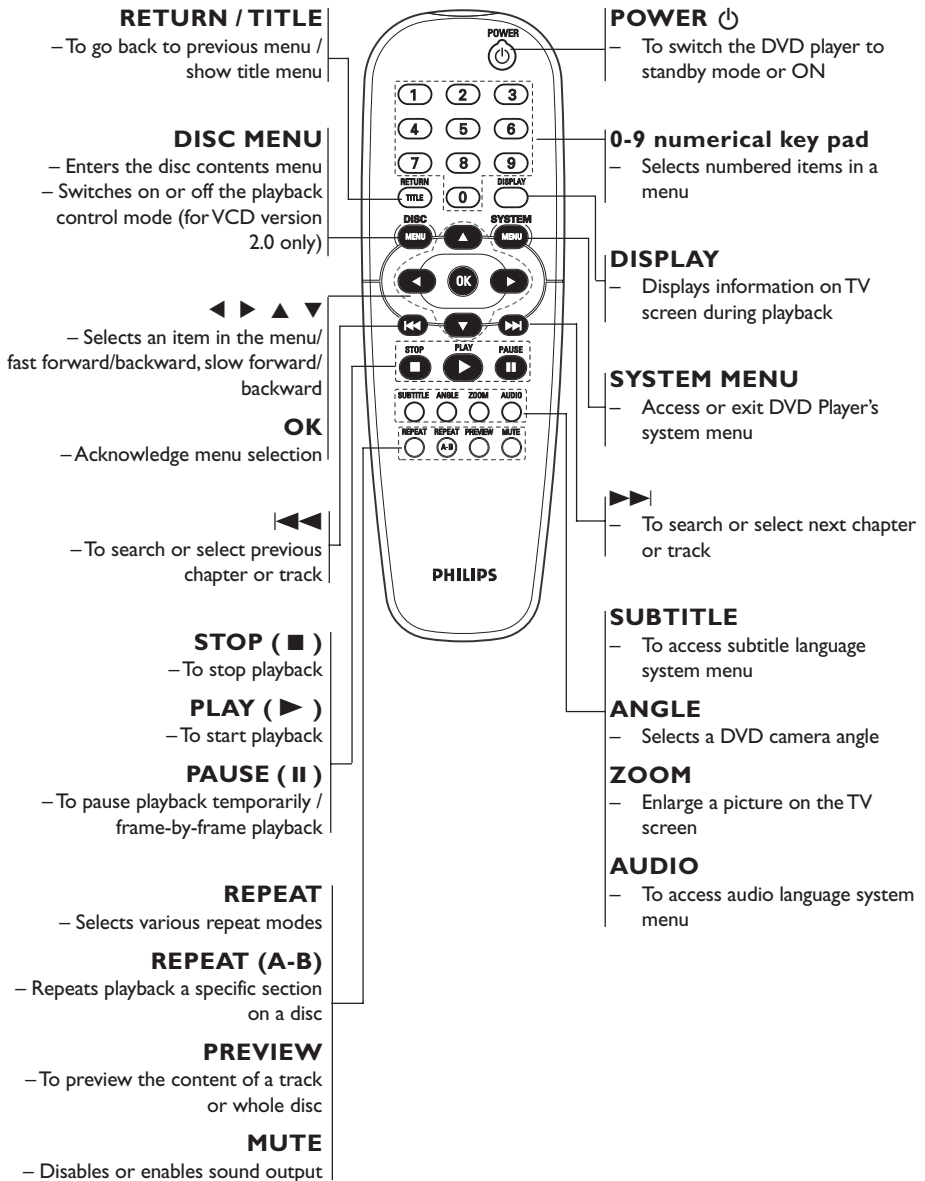

Step 1: Inserting batteries into the Remote Control

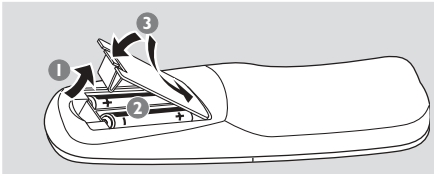

- 1 Open the battery compartment.
- 2 Insert two batteries type R06 or AA, following the indications (+ -) inside the compartment.
- 3 Replace the cover.

Using the Remote Control to operate the Player

- 1 Aim the Remote Control directly at the remote sensor (iR) on the front panel of the DVD Player.
- 2 Do not put any objects between the Remote Control and the DVD Player while operating the DVD Player.



CAUTION!

- Remove batteries if they are exhausted or if the Remote Control will not be used for a long time.
- Do not use old and new or different types of batteries in combination.
- Batteries contain chemical substances, so they should be disposed properly.

Step 2: Setting up the TV

IMPORTANT!

Make sure you have completed all the necessary connections. (See pages 9-10 “Connecting TV”).

- 1 Turn on the TV and set it to the correct Video-In channel. You should see the blue Philips DVD background screen on the TV.
 - 2 Usually these channels are between the lowest and highest channels and may be called FRONT, A/V IN, or VIDEO. See your TV manual for more details.
 - Or, you may go to channel 1 on your TV, then press the Channel down button repeatedly until you see the Video In channel.
 - Or, the TV Remote Control may have a button or switch that chooses different video modes.
 - Or, set the TV to channel 3 or 4 if you are using an RF modulator.
 - 3 If you are using other external equipment (audio system or receiver), turn it on and select the appropriate input source for the DVD Player. Refer to the equipment owner's manual for details.





Deactivate Progressive Scan manually

The progressive scan display presents 60 complete frames per second, rather than 30 frames per second of interlaced scanning (normal TV system). With nearly double the number of lines, progressive scan offers higher picture resolution and eliminates bothersome motion artifacts jagged edges on moving objects.

To enjoy the quality offered by progressive scan, a progressive scan TV is required. To activate progressive scan, refer to 'Progressive' on page 30.

Getting Started





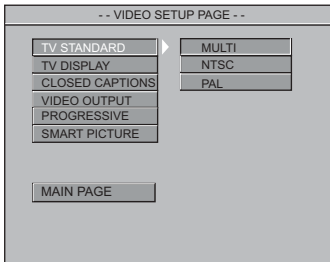

If the progressive function is activated but your TV does not support progressive scan or the cables are not connected accordingly, the TV screen will be blank. You can deactivate progressive scan as below.

- 1 Press **STANDBY ON**  on the front panel to switch on the DVD player.
- 2 Press **OPEN/CLOSE**  on the front panel to open the disc tray.
- 3 Press **STOP**  on the front panel.
- 4 Press **PLAY/PAUSE**  on the front panel.
→ The blue Philips DVD background appears on the TV screen.

Selecting the color system that corresponds to your TV

This DVD Player is compatible with both NTSC and PAL. In order for a DVD to play on this Player, the color system of the Disc, the TV and the DVD Player should match.



- 1 Press **SYSTEM MENU**.
- 2 Press   to select 'Video Setup Page'.
- 3 Enter its submenu by pressing **OK**.
- 4 Use the     keys on the Remote Control to navigate in the menu.
Move to 'TV Standard' and press .

PAL – Select this if the connected TV has the PALcolor system. It will change the video signal of an NTSC disc and output it in PAL format.

NTSC – Select this if the connected TV has the NTSC color system. It will change the video signal of a PAL disc (VCD only) and output it in NTSC format.

Multi – Select this if the connected TV is compatible with both NTSC and PAL (multi-system). The output format will be in accordance with the video signal of the disc.

Helpful Hint:

- **Before changing the current TV Standard setting, determine the color system of your TV**
- **If there is not a proper picture on your TV, wait for 15 seconds for auto recover.**

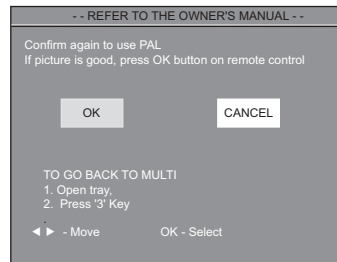
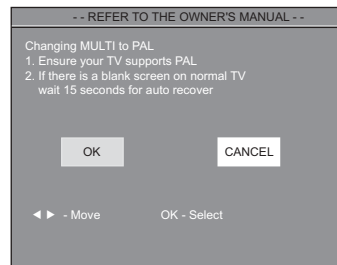

To exit from the menu
Press **SYSTEM MENU**.

Step 3: Setting language preferences

You can select your preferred language settings. This DVD Player will automatically switch to the language for you whenever you load a disc. If the language selected is not available on the disc, the disc's default language will be used instead. The OSD (on-screen display) language for the system menu will remain as you set it, regardless of various disc languages.

Setting the OSD Language

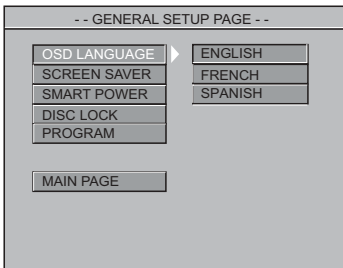

- 1 Press **SYSTEM MENU**.
- 2 Press **▼▲** to select 'General Setup' page.
- 3 Enter its submenu by pressing **OK**.
- 4 Use the **◀▶▲▼** keys on the Remote Control to navigate in the menu. Move to 'OSD Language' and press **▶**.
- 5 Select a language and press **OK**.

To exit from the menu
Press **SYSTEM MENU**.

Setting the Audio, Subtitle and Disc menu languages

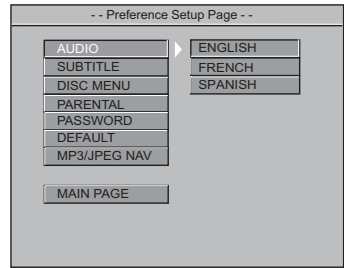

- 1 Press **STOP** twice, then press **SYSTEM MENU**.
- 2 Press **▼▲** to select 'Preferences Page'.
- 3 Enter its submenu by pressing **OK**.
- 4 Press **▲▼** to highlight one of the following in the Preferences Page.
 - 'Audio' (disc's soundtrack)
 - 'Subtitle' (disc's subtitles)
 - 'Disc Menu' (disc's menu)
- 5 Enter its submenu by pressing **▶**.
- 6 Select a language and press **OK**.
- 7 Repeat steps 4~6 for other language settings.

To exit from the menu
Press **SYSTEM MENU**.

Disc Operations

IMPORTANT!

- Depending on the DVD or VIDEO CD, some operations may be different or restricted.
- Do not push on the disc tray or put any objects other than discs in the disc tray. Doing so may cause the disc player to malfunction.

Playable Discs

Your DVD Player will play:

- Digital Video Discs (DVDs)
- Video CDs (VCDs)
- SuperVideo CDs (SVCDs)
- Finalized Digital Video Discs + Recordable (DVD+R)
- Finalized Digital Video Discs + Rewritable (DVD+RW)
- Audio Compact Discs (CDs)
- MP3 files disc on CD-R(W):
 - Maximum 30 characters display
 - Supported sampling frequencies : 32 kHz, 44.1 kHz, 48 kHz (MPEG-1) 16 kHz, 22.05 kHz, 24 kHz (MPEG-2)
 - Supported bitrates : 32-256 kbps (MPEG-1), 8-160 kbps (MPEG-2) variable bitrates
- Picture files on CD-R/CD-RW:
 - JPEG pictures.
 - KODAK pictures.
 - Fuji color pictures.
- MPEG-4 files on CD-R/CD-RW:
 - Simple profile
 - Advanced simple profile (640-480)
- DivX[®] disc on CD-R/CD-RW:
 - DivX 4.x and 5.x
 - GMC (Global Motion Compensation) and Q-Pel (Quarter Pixel) not supported

This DVD Player can play DivX, MPEG-4, MP3, JPEG, VCD & SVCD files on a personally recorded CD-R/CD-RW disc or commercial CD.

- Maximum files programmable is 24.
- MP3: Maximum supported bitrate is 320 kbps or 48 kHz.
- DivX4.x and 5.x comply with this standard, except GMC (Global Motion Compensation) and QP (Quarter Pixel) features.
- MPEG-4: All video codecs that comply with specifications of ISO-MPEG4.
- JPEG: For baseline JPEG, maximum resolution is 5120 x 3840 (beyond this picture will be cropped). For progressive JPEG, maximum resolution is 2048 x 1536 (beyond this, picture will not be displayed).

Region Codes

DVDs must be labeled for ALL regions or Region 1 in order to play on this Player. You cannot play Discs that are labeled for other regions.

Look for the symbols on your DVD's.



Helpful Hint:



- If you are having trouble playing a certain disc, remove the disc and try a different one. Improperly formatted disc will not play on this DVD Player.

IMPORTANT!



If the inhibit icon appears on the TV screen when a button is pressed, the function is not available on the current disc or at the current time.





Playing discs

- 1 Connect the power cords of the DVD Player and TV (and any optional stereo or receiver) to a power outlet.
- 2 Turn on the TV and set it to the correct Video In channel. (See page 15 “Setting up the TV”).
- 3 Press **STANDBY-ON**  on the front of the DVD Player.
→ You should see the blue Philips DVD background screen on the TV.
- 4 Press **OPEN•CLOSE**  to open the disc tray and load a disc. Press again to close the disc tray.
→ Make sure the label is facing up. For double-sided discs, make sure the label of the side you want to play is facing up.
- 5 Playback may start automatically (depending on the disc type).
→ If a disc menu appears on the TV, see “Using the Disc Menu”.
→ If the disc is locked by parental control, you must enter your four-digit password. (See page 32).
- 6 At any time, simply press **STOP**  to stop playback.

Using the Disc Menu

Depending on the disc, a menu may appear on the TV screen once you load the disc.

To select a playback feature or item

- Use the     or numeric keypad (0-9) on the Remote Control, then press **PLAY**  to start playback.



To access the menu

- Press **DISC MENU** on the Remote Control.





Basic playback controls

Unless otherwise stated, all operations described are based on Remote Control use.

Pausing playback (DVD/VCD/CD)

- 1 During playback, press **PAUSE II**.
→ Play will pause and sound will be mute.
- 2 During pause mode, press   to select the previous or next picture frame.
- 3 To return to normal playback, press **PLAY** .

Selecting a title (track) /chapter (DVD/VCD/CD)

- Press   /   or use the numeric keypad (0-9) to key in a title (track) / chapter number.

Disc Operations

Mute (DVD/VCD/CD/MP3/DivX/JPEG)

- Press **MUTE** repeatedly to disable and enable the sound.

Resuming playback from the last stopped point (DVD/VCD/CD)

Resume playback of the last five discs, even if the disc was removed from the Player.

- 1 Load one of the last five discs.
→ "LOADING" appears.
- 2 Press **PLAY** ► and the disc will play from the last point.

To cancel resume mode

- While play is stopped, press **STOP** ■ again.

Helpful Hint:

- Resume may not be available on some discs.

Zoom (DVD/VCD)

Zooming allows you to enlarge the video image during playback.

- 1 Press **ZOOM** during playback to select the zoom factor.
- 2 Press ◀▶ ▲▼ to move through the zoomed image.
- 3 Press **ZOOM** repeatedly to increase and decrease the zoom factor.
→ Playback will continue.

Repeat (DVD/VCD/CD/MP3)

You can play a chapter, track, title or entire disc repeatedly.

- Press **REPEAT** continuously to choose a Repeat mode during playback.

→ **DVD**

'CHAPTER REPEAT ON/TITLE REPEAT ON/REPEAT OFF'.

→ **VCD / CD**

'REP-ONE/REP-ALL/REPEAT OFF'.

For VCD2.0, SVCD discs:

- Not available if Playback Control is on (PBC On).

→ **MP3**

If 'MP3/JPEG Nav' is WITH MENU:

'REP-ONE/FOLDER REPEAT/REP-ALL/REPEAT OFF'.

If 'MP3/JPEG Nav' is NO MENU:

'REP-ONE/REP-ALL/REPEAT OFF'.

Helpful Hint:

- Repeat options are not available on some discs.

Repeat A-B (DVD/VCD/CD)

You can play only a specific portion of a Title/Track or Chapter repeatedly.

- 1 During playback, press **REPEAT A-B** at your chosen starting point.
→ 'A TO B SET A' appears on the TV screen.
- 2 When the disc reaches your selected ending point, press **REPEAT A-B** again.
→ 'A TO B SET B' appears on the TV screen, and the repeat sequence begins.
- 3 To resume regular playback, press **REPEAT A-B** again.
→ 'A TO B CANCELLED' appears on the TV screen.

Display (DVD/VCD)

The Display function allows you to start playback at any chosen time on the disc.

- 1 During playback, press and hold **DISPLAY** until the time edit box appears.
 - 2 Press **DISPLAY** once.
Use ◀▶ to highlight one of the options and use the numeric key pad (0-9) to enter the number of title (track) /chapter.
 - 3 Press **DISPLAY** twice.
Use ▶ to highlight the time option and use the numeric key pad (0-9) to enter hours, minutes and seconds from left to right in the time edit box.
 - 4 Press **OK** to confirm.
→ Playback starts from the selected time on the disc.
- Highlight 'TIME', then press ▲ ▼ to view the status of the playing disc.

For DVD

→ 'TITLE ELAPSED/ TITLE REMAIN/ CHP ELAPSED/ CHP REMAIN' appears.

For VCD

→ 'SINGLE ELAPSED/ SINGLE REMAIN/ TOTAL ELAPSED/ TOTAL REMAIN' appears.

Slow Motion (DVD/VCD/SVCD)

During playback, press ▲ or ▼ to select slow reverse (SR) or slow forward (SF).

→ DVD

- Press ▲ or ▼ repeatedly to select the slow reverse or slow forward speed:
SFx2 → SFx4 → SFx8 → PLAY
SRx2 → SRx4 → SRx8 → PLAY
- **VCD / SVCD**
- Press ▲ repeatedly to select the slow forward speed:
SFx1 → SFx2 → SFx3 → PLAY

Helpful Hint:

- Slow Reverse is not available in VCD/ SVCDs.

Searching

(DVD/VCD/SVCD/CD/MP3)

- Press ◀ or ▶ repeatedly to select fast reverse (FR) search or fast forward (FF) search.

→ DVD / MP3

FRx2 → FRx4 → FRx6 → FRx8 → PLAY
FFx2 → FFx4 → FFx6 → FFx8 → PLAY

→ VCD / SVCD / CD

FRx1 → FRx2 → FRx3 → FRx4 → PLAY
FFx1 → FFx2 → FFx3 → FFx4 → PLAY

Program Playback

(DVD/VCD/CD)

- 1 Press **SYSTEM MENU**. Press ▼ ▲ to select 'General Setup Page'.
- 2 Select 'Program' and set it to ON, then press **OK** (see page 26, 'Program').
→ The 'Program' menu appears.
- 3 Use the ◀▶ ▲ ▼ keys and numeric keypad (0-9) on the Remote Control to select a title (track) /chapter.
- 4 Press **PLAY** ▶ to start playback.
→ For DVD, the maximum programmable titles or chapters is 16.
→ For VCD/CD, the maximum programmable tracks is 24.

- **To erase a selection in the Program**
Use the ◀▶ ▲ ▼ keys to select the item(s), then press **OK** to delete.
- **To list the programmed item(s)**
While play is stopped, press **SYSTEM MENU**.
Select 'Program' and set it to ON, then press ▶.

Disc Operations

Special DVD Features

Playing a Title

- 1 Press **RETURN/TITLE**.
→ The disc title menu appears on the TV screen.
- 2 Use **▲▼◀▶** or the **numeric keypad (0-9)** to select a play option.
- 3 Press **OK** to confirm.

Camera Angle

- Press **ANGLE** repeatedly to select a different desire angle. Multiple angles or perspectives are not available on all discs.

Changing the Audio Language

For DVD

- Press **AUDIO** repeatedly to select different audio languages if available on the DVD.

Changing the Audio Channel

For VCD

- Press **AUDIO** repeatedly to select the available audio channels provided by the disc (LEFT VOCAL, RIGHT VOCAL, LEFT MONO, RIGHT MONO, STEREO).

Subtitles

- Press **SUBTITLE** repeatedly to select different subtitle languages if available on the DVD.

Special VCD & SVCD Features

Playback Control (PBC)

For VCD's with Playback Control (PBC) feature (version 2.0 only)

- Press **DISC MENU** repeatedly to toggle between 'PBC ON' and 'PBC OFF'.
→ If you select 'PBC ON', the disc menu (if available) will appear on the TV.
→ Use **◀◀ / ▶▶** or the numeric keypad (0-9) to select a play option.
- During playback, pressing **RETURN/TITLE** will return to the menu screen (if PBC is on).

To skip the index menu and play the Disc directly from the beginning;

- Press **DISC MENU** to turn off Playback Control (PBC).

Preview (VCD/SVCD/CD)

For VCD/SVCD

- While play is stopped, press **PREVIEW** on the remote control.
→ The preview menu will be displayed.

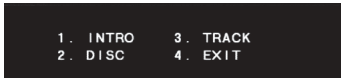

1. INTRO

The DVD Player will play every track for a few seconds providing a summary of the disc content.

- 1 Press **1** on the numerical key pad.
- 2 Press **STOP** to quit previewing.

2. DISC

Divide a disc into nine segments by regular intervals and display them on one page to help you preview the whole disc.



- 1 Press **2** on the numerical key pad.
→ The preview of nine tracks will appear on the TV screen.
- 2 To select other tracks, press **◀◀** or **▶▶**.
- 3 Use the numerical key pad to select a track to play.

3. TRACK

Divide a single track into nine segments by regular intervals and display them on one page to help you preview the selected track.



- 1 Press **3** on the numerical key pad.
→ Nine segments of the track will preview on the TV screen.
- 2 To select other tracks, press **◀◀** or **▶▶**.
- 3 Use the numerical key pad to choose a track segment at which to start play.

4. EXIT

- 1 Press **4** on the numerical key pad.

For CD

- While play is stopped, press **PREVIEW** on the remote control.
→ Each track will play for about 10 seconds.
→ For a JPEG CD, press **PREVIEW** to view nine thumbnail pictures on the TV screen (see page 24).

Disc Operations

Playing MP3/DivX/MPEG-4/ JPEG/Kodak Picture CD

IMPORTANT!

You have to turn on your TV and set it to the correct Video In channel. (See page 15 "Setting up the TV").

General Operation

- 1 Load an MP3/DivX/MPEG-4/JPEG disc.
→ The DATA CD MENU appears on the TV screen.
- 2 Use ▲ ▼ to select a folder. Press **OK** to open the folder.

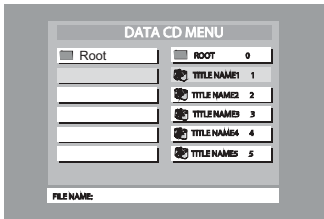

- 3 Press ▲ ▼ or use the numeric keypad (0-9) to highlight an option.
 - 4 Press **OK** to confirm.
→ Playback will start at the selected file and continue to the end of the folder.
- During MP3 playback, the selected track name and current playing time will be displayed under the 'File Name'.
 - If the 'MP3/JPEG Nav' is set to NO MENU, the DATA CD MENU will not appear on the TV screen (see page 33).

Helpful Hint:

– Kodak Picture CD, playback will start automatically without a disc menu.
Press **STOP** ■ to display thumbnails of nine pictures.

Playback selection

During playback, you can:

- Press |◀◀/▶▶| to select another file in the current folder.
- During playback, press ▲▼◀▶ to rotate the picture on the TV screen.
- Press **PAUSE** II to pause playback.

Special MP3/JPEG features

Preview (JPEG)

This shows the content of the current folder or the whole disc.

- 1 While play is stopped, press **PREVIEW**.
→ Thumbnails of nine pictures appear on the TV screen.

(example for nine thumbnail pictures)



- 2 Press |◀◀/▶▶| to display other pictures on the previous/next page.
- 3 Use ◀▶▲▼ to highlight a picture. Press **OK** to start playback,

Zoom picture (JPEG)

- During playback, press **ZOOM** repeatedly to choose 'ZOOM ON' or 'ZOOM OFF'.
- Press |◀◀/▶▶| to display the picture with different zoom factors.
- Use ◀▶▲▼ to move through the zoomed picture.

Playback with multi-angles (JPEG)

- During playback, press ▲▼◀▶ to rotate the picture on the TV screen.
▲: flip the picture vertically
▼: flip the picture horizontally
◀: rotate the picture counter-clockwise
▶: rotate the picture clockwise

Scan Effect (JPEG)

- Press **ANGLE** repeatedly to choose different scan effect.
→ Various scan effects appear in the top left corner of the TV screen.

Playback speed control (MP3)

- Press ◀/▶ repeatedly to play backward/forward at different speeds.
- Press |◀◀/▶▶| to change tracks.

DVD Menu Options

Basic Operations

- 1 Press **SYSTEM MENU** when play is stopped to enter the Setup Menu.
- 2 Press **OK** to enter the next level submenu or confirm your selection.
- 3 Press **◀▶** to enter the submenu or return to the previous menu.
- 4 Press **▲▼** to highlight the desired menu.
- 5 Press **SYSTEM MENU** to quit the setup menu.
→ The settings will be stored in the player's memory even if after the player is switched off.

General Setup menu

The options in General Setup menu are: 'OSD Language', 'Screen Saver', 'Smart Power', 'Disc Lock' and 'Program'.

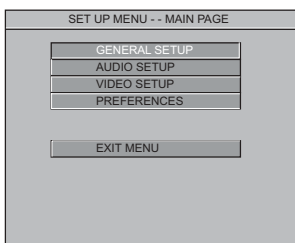

- 1 Press **SYSTEM MENU** to enter the setup menu.
- 2 Press **▲▼** to select 'General Setup' page.
- 3 Press **OK** to confirm.

NOTE:

Some of the features in the DVD Menu Options are described in "Getting Started".

Screen Saver

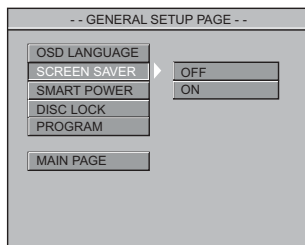

- 1 Press **▲▼** to highlight 'Screen Saver'.
- 2 Enter its submenu by pressing **▶**.
- 3 Press **▲▼** to choose a setting.
→ **Off**: Screen saver is disabled.
→ **On**: When play is stopped or if no Disc is in the Player, and if no actions are performed within five minutes, the screen saver will be activated.
- 4 Press **OK**, then press **◀** to return to the General Setup Page.

Smart Power

When play is stopped or if no Disc is in the Player, the DVD Player will switch to standby mode after fifteen minutes of inactivity to save energy.

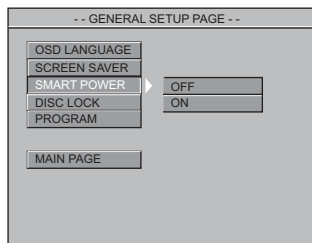

- 1 Press **▲▼** to highlight 'Smart Power'.
- 2 Enter its submenu by pressing **▶**.
- 3 Press **▲▼** to choose a setting.
→ **Off**: Smart Power is disabled.
→ **On**: When play is stopped or if no Disc is in the Player, and if no actions are performed for 15 minutes, the Player will turn off.
- 4 Press **OK**, then press **◀** to return to the General Setup Page.

DVD Menu Options

Disc Lock (DVD/VCD/CD)

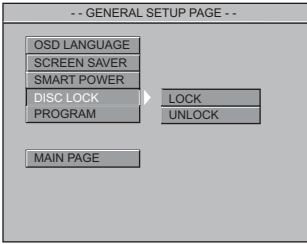

- 1 Press ▲▼ to highlight 'Disc Lock'.
- 2 Enter its submenu by pressing ►.
- 3 Press ▲▼ to choose a setting.
→ **Lock**: Select this option and the player will lock the current playing disc.
→ **Unlock**: Select this option and the player will unlock the current playing disc.
- You will need to enter the password to confirm unlock selection. Use the numerical keypad (0-9) on the remote. The default password is 1234 (see 'Password' on page 32).
- 4 Press **OK**, then press ◀ to return to the General Setup Page.

Helpful Hint:

– When a locked disc is in the Player, a menu will appear.

Program

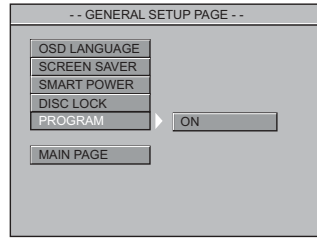

- 1 Press ▲▼ to highlight 'Program'.
- 2 Enter its submenu by pressing ►.
→ **On**: Select this option to activate program function.
- 3 Press **OK** to enter to 'Program' menu (see 'Program Playback' on page 21).

For VCD

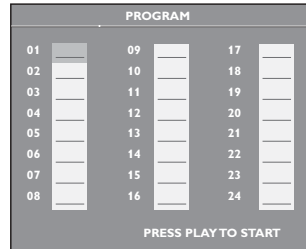

For DVD

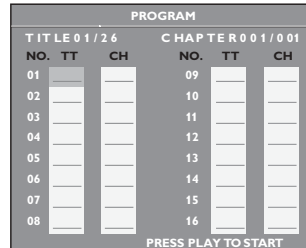

DVD Menu Options

Audio Setup Menu

The options in the Audio Setup menu are: 'Downmix', 'Digital Output', 'LPCM Output', 'Sound Mode', 'Reverb Mode' and 'D.R.C. (Dynamic Range Control)'.

- 1 Press **SYSTEM MENU**.
- 2 Press **▲▼** to select the 'Audio Setup' page.
- 3 Press **OK** to confirm.

Downmix

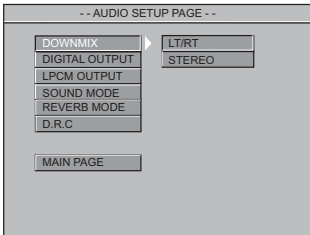

- 1 Press the **▲▼** keys to highlight 'Downmix'.
- 2 Enter its submenu by pressing **▶**.
- 3 Press **▲▼** to choose a setting.
→ **LT/RT**: Select this option if your DVD Player is connected to a Stereo with a Dolby Pro Logic decoder.
→ **Stereo**: Select this option if the TV or Stereo has right and left Audio In jacks but does not have Dolby Pro Logic.
- 4 Press **OK**, then press **◀** to return to the Audio Setup Page.

Digital Output

Set Digital output according to the optional audio equipment you connected.

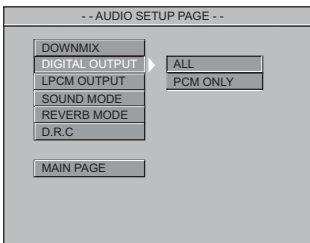

- 1 Press **▲▼** to highlight 'Digital Output'.
- 2 Enter its submenu by pressing **▶**.
- 3 Press **▲▼** to choose a setting.
→ **All**: If you connected the DVD Player's Digital (Coaxial or Optical) jack to a multi-channel decoder/receiver.
→ **PCM Only**: Only if your receiver is not capable of decoding multi-channel audio.
- 4 Press **OK**, then press **◀** to return to the Audio Setup Page.

Helpful Hint:

– If **DIGITAL OUTPUT** is set to 'All', all audio settings except **MUTE** are invalid.

LPCM Output

If you connect the DVD Player to a PCM compatible receiver using Player's Digital (Coaxial or Optical) jack, you may need to adjust 'LPCM Output'.

Discs are recorded at a certain sampling rate, measured in kHz. The higher the sampling rate, the better the sound quality.

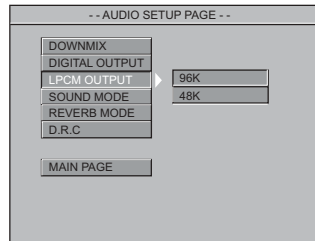

- 1 Press **▲▼** to highlight 'LPCM Output'.
- 2 Enter its submenu by pressing **▶**.
- 3 Press **▲▼** to choose a setting.
→ **48K**: Play a disc recorded at the sampling rate of 48 kHz.
→ **96K**: Play a disc recorded at the sampling rate of 96 kHz.
- 4 Press **OK**, then press **◀** to return to the Audio Setup Page.

Helpful Hint:

– The average setting for most Discs is **48K**.

DVD Menu Options

Sound Mode

The digital sound effect allows you to select from various pre-set modes that control the frequency bands of optimized certain musical styles. It enhances the excitement and enjoyment of your favorite music.

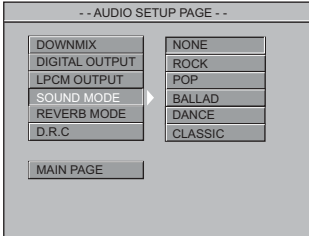

- 1 Press ▲▼ to highlight 'Sound Mode'.
- 2 Enter its submenu by pressing ►.
- 3 Press ▲▼ to choose a setting.
→ **None, Rock, Pop, Ballad, Dance, Classic**
- 4 Press **OK**, then press ◀ to return to the Audio Setup Page.

Reverb Mode

Reverb mode provides a virtual surround sound effect even when the DVD Player is connected to a Stereo or TV that has only left/right stereo sound capability.

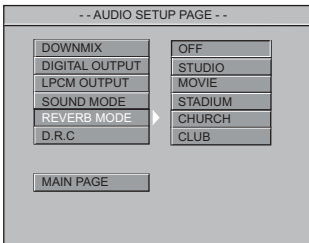

- 1 Press ▲▼ to highlight 'Reverb Mode'.
- 2 Enter its submenu by pressing ►.
- 3 Press ▲▼ to choose a setting.
→ **Off, Studio, Movie, Stadium, Church, Club**
- 4 Press **OK**, then press ◀ to return to the Audio Setup Page.

D.R.C. (Dynamic Range Control)

High volume outputs are softened, enabling you to watch your favorite action movie without disturbing others at night.

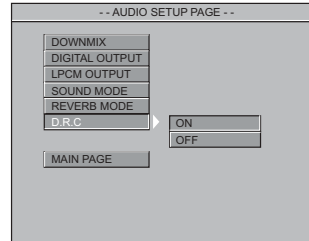

- 1 Press ▲▼ to highlight 'D.R.C'.
- 2 Enter its submenu by pressing ►.
- 3 Press ▲▼ to choose a setting.
→ **Off**: The dynamic range of the audio is not compressed. You will hear the highs and lows of the sounds.
→ **On**: The dynamic range of the audio is compressed. The loud and soft sound will be leveled evenly, reducing sudden bursts of loud sounds.
- 4 Press **OK**, then press ◀ to return to the Audio Setup Page.

DVD Menu Options

Video Setup Menu

The options in the Video Setup menu are: 'TV Standard', 'TV Display', 'Closed Captions', 'Video Output', 'Progressive' and 'Smart Picture'.

- 1 Press **SYSTEM MENU**.
- 2 Press **▲▼** to select 'Video Setup' page.
- 3 Press **OK** to confirm.

TV Display

Set the aspect ratio of the DVD Player according to the TV you have connected and the Discs you are playing.

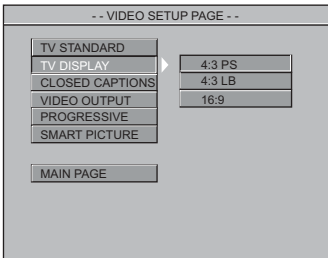

- 1 Press **▲▼** to highlight 'TV Display'.
- 2 Enter its submenu by pressing **▶**.
- 3 Press **▲▼** to choose a setting.

16:9



4:3
Letter Box



4:3
Pan Scan



16:9

→ If you have a wide screen TV.

4:3 Letter Box

→ If you have a standard TV. In this case, a wide picture with black bands on the upper and lower portions of the TV screen will be displayed.

4:3 Pan Scan

→ If you have a regular TV and want both sides of the picture to be trimmed or formatted to fit your TV screen.

- 4 Press **OK**, then press **◀** to return to the Video Setup Page.

Closed Captions

Closed captions are data that is hidden in the video signal on specific discs, invisible without a special decoder. The difference between subtitles and closed captions is that subtitles are intended for hearing persons, and closed captions are for the hearing impaired. For example, closed captions show sound effects (e.g., "phone ringing" and "footsteps"), while subtitles don't.

Before you select this function, please ensure that the disc contains closed captions information and your TV also has this function.

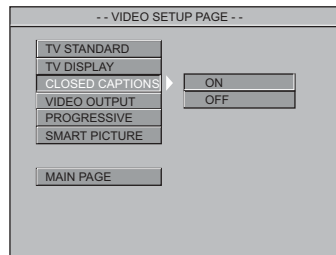

- 1 Press **▲▼** to highlight 'Closed Captions'.
- 2 Enter its submenu by pressing **▶**.
- 3 Press **▲▼** to choose a setting.
 - **On**: Enable Closed Captions.
 - **Off**: Disable Closed Captions.
- 4 Press **OK**, then press **◀** to return to the Video Setup Page.

DVD Menu Options

Video Output

Choose the type of video output that matches the connection of the DVD Player to your TV.

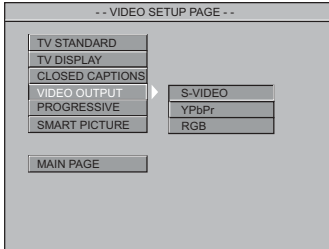

- 1 Press ▲▼ to highlight 'Video Output'.
- 2 Enter its submenu by pressing ►.
- 3 Press ▲▼ to choose a setting.
→ **S-Video**: If you have connected the S-Video Out jack to a TV.
→ **YPbPr**: If you have connected the YPbPr Out jacks to a TV.
→ **RGB**: If you have connected the RGB out jack to a TV.
- 4 Press **OK**, then press ◀ to return to the Video Setup Page.

Progressive

To select this item you must set 'Video Output' to YPbPr (see left) and ensure your TV has progressive scan.

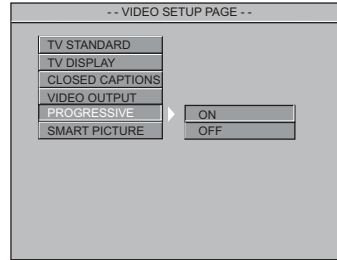

- 1 Press ▲▼ to highlight 'Progressive'.
- 2 Enter its submenu by pressing ►.
- 3 Press ▲▼ to choose a setting.
→ **On**: Enable Progressive Scan video.
→ **Off**: Disable Progressive Scan video.
- 4 Press **OK**, then press ◀ to return to the Video Setup Page.

Helpful Hint:

- If a blank/distorted TV screen appears, wait for 15 seconds for auto recover.
- To deactivate the progressive function, refer to the hint menu displayed on the TV screen or see pages 15 and 16.

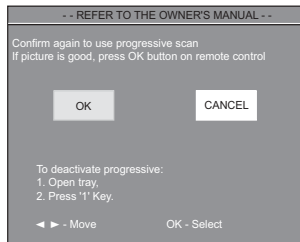
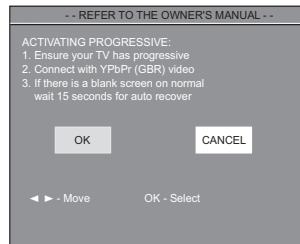

DVD Menu Options

Smart Picture

In this menu, you can choose an ideal predefined picture setting.

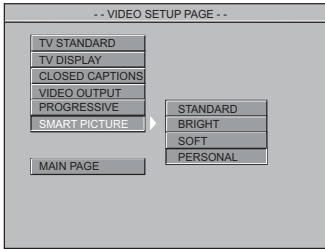

- 1 Press **▲▼** to highlight 'Smart Picture'.
- 2 Enter its submenu by pressing **▶**.
- 3 Press **▲▼** to choose a setting.
→ **Standard**: select the standard picture setting.
→ **Bright**: make the TV picture brighter.
→ **Soft**: make the TV picture softer.
→ **Personal**: set the 'Brightness', 'Contrast', 'Hue' and 'Saturation' as you prefer (see 'Brightness' below).
- 4 Press **OK**, then press **◀** to return to the Video Setup Page.

Brightness

You can personalize your picture by adjusting brightness, contrast, hue and saturation.



- 1 Press **◀▶** to highlight 'Brightness'.
- 2 Press **▼** to open the level bar.
- 3 Press **◀▶** to decrease or increase the brightness level.
- Repeat steps 1 - 4 for adjusting the contrast, hue and saturation.
- 4 Press **OK** to exit.

Preferences Menu

The options in the Preferences menu are: 'Audio', 'Subtitle', 'Disc Menu', 'Parental', 'Password', 'Default' and 'MP3/JPEG Nav'.

- 1 Press **STOP** twice.
- 2 Press **SYSTEM MENU** to enter the setup menu.
- 3 Press **▲▼** to select the 'Preferences' page.
- 4 Press **OK** to confirm.

Parental

Some DVDs may have a parental level assigned to the complete disc or to certain scenes on the disc. This feature lets you set a playback limitation level. The rating levels are from 1 to 8 and are country dependent. You can prohibit the playing of certain discs that are not suitable for your children or have certain discs played with alternative scenes.

- VCD, SVCD, CD have no level indication, so parental control has no effect on those kinds of discs. This also applies to most illegal DVDs.

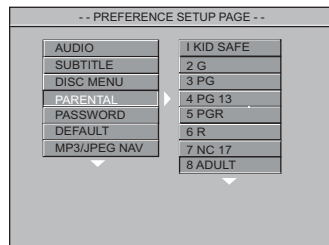

DVD Menu Options

Parental - cont'd

- 1 Press **▲▼** to highlight 'Parental'.
- 2 Enter its submenu by pressing **►**.
- 3 Use **▲▼** to highlight a rating level for the disc inserted.
→ DVDs that are rated above the level you selected will not play unless you enter your four-digit password and choose a higher level rating.
→ To disable Parental controls and have all Discs play, choose 'No Parental'.
- 4 Press **OK**, then press **◀** to return to the Preferences Setup Page.

Helpful Hint:

– Some DVDs are not encoded with a rating though the movie rating may be printed on the Disc cover. The rating level feature does not prohibit play of such Discs.

Rating explanations

1KID SAFE - 2 G

– General Audience; recommended as acceptable for viewers of all ages.

3 PG

– Parental Guidance suggested.

4 PG13

– Material is unsuitable for children under age 13.

5 PGR - 6 R

– Parental Guidance - Restricted; recommended that parents restrict children under 17 from viewing or allow to view only when supervised by a parent or adult guardian.

7 NC-17

– No children under age 17; not recommended viewing for children under age 17.

8 ADULT

– Mature material; should be viewed only by adults due to graphic sexual material, violence or language.

NO PARENTAL

– All discs will play.

Password

This feature is used for Parental Control. Enter your four digit password to play a prohibit Disc or if prompt for a password. The default password is 1234.

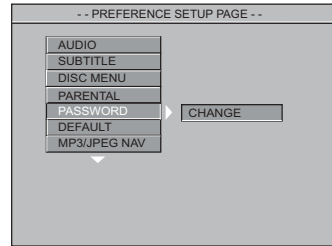

- 1 Press **▲▼** to highlight 'Password'.
- 2 Enter its submenu by pressing **►**.
- 3 Press **OK** to open the password 'Change' page.

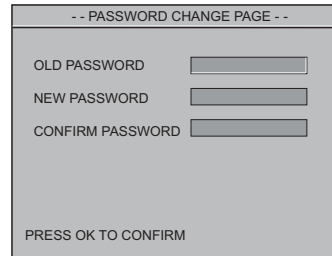

- 4 Enter your current password as the PLD PASSWORD. Use the numerical keypad (0-9) on the remote.
- 5 Enter a new four-digit code.
- 6 Enter the new four-digit code a second time to confirm.
→ The new four-digit code will take effect.
- 7 Press **OK**, then press **◀** to return to the Preference Setup Page.

Helpful Hints:

– If the new password has been set, the Parental and Disc Lock code will also be changed to new password. The default password won't take effect.

– To reset the password to the default setting (1234), press **STOP** four times.

DVD Menu Options

Default

Setting the 'Default' function will reset all options to the factory defaults. Your personal settings will be erased.

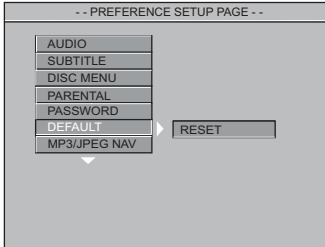

- 1 Press ▲▼ to highlight 'Default'.
- 2 Highlight RESET by pressing ►.
- 3 Press OK, then press ◀ to return to the Preference Setup Page.

Caution!

– **When this function is activated, all settings will reset to factory defaults.**

MP3/JPEG Navigator

This feature allows you to select alternate settings when you playback picture CDs (JPEG/DivX) and MP3 CDs.

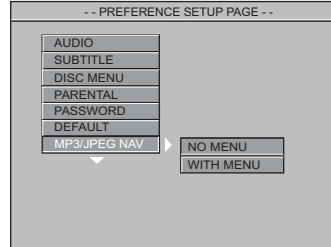

- 1 Press ▲▼ to highlight 'MP3/JPEG Nav'.
- 2 Enter its submenu by pressing ►.
- 3 Press ▲▼ to choose a setting.
→ **No Menu:** playback all files in sequence automatically without a menu.
→ **With Menu:** playback files in the selected folder within a menu.
- 4 Press OK, then press ◀ to return to the Preference Setup Page.

Helpful Hints:

- MP3/JPEG Nav can be set to WITH MENU only if the disc was recorded with menu.
- It may not be available on some discs, even though it is set to 'WITH MENU'.

Specifications

TV STANDARD (PAL/50Hz) (NTSC/60Hz)

Number of lines	625	525
Playback	Multistandard	(PAL/NTSC)

VIDEO PERFORMANCE

CVBS	1Vpp — 75
YPbPr	0.7Vpp — 75

VIDEO FORMAT

Digital Compression	MPEG 2 for DVD,SVCD
	MPEG 1 forVCD
	MPEG-4

DVD	50Hz	60Hz
Horiz. resolution	720 pixels	720 pixels
Vertical resolution	576 lines	480 lines

VCD	50Hz	60Hz
Horiz. resolution	352 pixels	352 pixels
Vertical resolution	288 lines	240 lines

AUDIO FORMAT

Digital	Mpeg/ AC-3/ PCM	compressed Digital 16, 20, 24 bits fs, 44.1, 48, 96 kHz
	MP3(ISO 9660)	96, 112, 128, 256 kbps & variable bit rate fs, 32, 44.1, 48 kHz

Analog Sound Stereo

Dolby Surround compatible downmix from Dolby Digital multi-channel sound

AUDIO PERFORMANCE

DA Converter	24 bit	
DVD	fs 96 kHz	4Hz- 44kHz
	fs 48 kHz	4Hz- 22kHz
SVCD	fs 48 kHz	4Hz- 22kHz
	fs 44.1kHz	4Hz- 20kHz
CD/VCD	fs 44.1kHz	4Hz- 20kHz
Signal-Noise (1kHz)		105 dB
Dynamic range(1kHz)		100 dB
Crosstalk (1kHz)		105 dB
Distortion/noise (1kHz)		90 dB
MPEG MP3	MPEG Audio L3	

CONNECTIONS

YPbPr Output	Cinch 3x (red, green, blue)
Video Output	Cinch (yellow)
Audio Output(L+R)	Cinch (white/red)
Digital Output	1 coaxial, 1 optical
	IEC60958 for CDDA / LPCM
	IEC61937 for MPEG 1/2,
	Dolby Digital

CABINET

Dimensions (w x h x d)	17.13 x 1.69 x 9.25 inch
	435 x 43 x 235 mm
Weight	Approximately 4.40 pound
	Approximately 2.0 kg

POWER CONSUMPTION

Power consumption in Standby mode	< 0.8 W
-----------------------------------	---------

Specifications subject to change without prior notice

Troubleshooting

WARNING

Under no circumstances should you try to repair the system yourself, as this will invalidate the warranty. Do not open the system as there is a risk of electric shock.

If a fault occurs, first check the points listed below before taking the system for repair. If you are unable to remedy a problem by following these hints, please call [1-800-531-0039](tel:1-800-531-0039) for help.

Problem	Solution
No power	<ul style="list-style-type: none">– Check if the AC power cord is properly connected.– Press the STANDBY ON  on the front of the DVD Player to turn on the power.
No picture	<ul style="list-style-type: none">– Refer to your TV's manual for correct Video In channel selection. Change the TV channel until you see the DVD screen.– Check if the TV is switched on.
Distorted picture	<ul style="list-style-type: none">– Sometimes a small amount of picture distortion may appear, depending on the disc being played. This is not a malfunction.
Completely distorted picture or black/white picture with DVD	<ul style="list-style-type: none">– Connect DVD Player directly to the TV.– Make sure the disc is compatible with the DVD Player.– Ensure that the DVD Player's TV Standard is set to match that of the Disc and your TV.
No sound or distorted sound	<ul style="list-style-type: none">– Adjust the volume.– Check the audio cables and make sure both are connected secured to the TV or Stereo Audio In jacks.
No audio at digital output	<ul style="list-style-type: none">– Check the digital connections.– Check if your receiver can decode MPEG-2 or DTS. Make sure digital output is set to PCM Only.– Check if the audio format of the selected audio language matches your receiver capabilities.
Disc can't play	<ul style="list-style-type: none">– A DVD+R/CD-R must be finalized.– Ensure the disc label is facing up.– Check if the disc is defective by trying another disc.– If you have recorded a Picture CD or MP3 CD yourself, ensure that your disc contains at least 10 pictures or 5 MP3 tracks.– Check the Disc's Region Code. It must be 1 or ALL.
Picture freezes momentarily during playback	<ul style="list-style-type: none">– Check the disc for fingerprints/scratches and clean with a soft cloth wiping from center to edge.
No return to start-up screen when disc is removed	<ul style="list-style-type: none">– Reset the unit by switching the player off, then on again.

Troubleshooting

Problem	Solution
The player does not respond to the Remote Control	<ul style="list-style-type: none">– Aim the Remote Control directly at the sensor on the front of the player.– Reduce the distance to the player.– Replace the batteries in the Remote Control.– Re-insert the batteries with their polarities (+/- signs) as indicated.
Buttons do not work	<ul style="list-style-type: none">– To completely reset the player, unplug the AC cord from the AC outlet for 5-10 seconds.
Player does not respond to some operating commands during playback.	<ul style="list-style-type: none">– Operations may not be permitted by the disc. Refer to the instructions of the disc jacket.
DVD Player cannot read CDs/DVDs	<ul style="list-style-type: none">– Use a commonly available cleaning CD/DVD to clean the lens before sending the DVD Player for repair.
Menu items cannot be selected	<ul style="list-style-type: none">– Press STOP twice before selecting the System Menu.– Depending on the disc availability, some menu items cannot be selected.
Unable to play DivX movies	<ul style="list-style-type: none">– Check that the DivX file is encoded in 'Home Theater' mode with DivX 5.x encoder.
DVD Player upgrades	<ul style="list-style-type: none">– If a DVD does not play properly, contact Philips at 1-800-531-0339 for assistance. Due to the inconsistency of Disc formats provided by various Disc manufacturers, your DVD Player may require a playability enhancement. As DVD technology has advanced, these enhancements have become both common and easy to complete.

If you are unable to remedy a problem by following these hints, contact Philips.

Analog: Sound that has not been turned into numbers. Analog sound varies, while digital sound has specific numerical values. These jacks send audio through two channels, the left and right.

Aspect ratio: The ratio of vertical and horizontal sizes of a displayed image. The horizontal vs. vertical ratio of conventional TVs is 4:3, and that of wide-screens is 16:9.

AUDIO OUT Jacks: Red and white jacks on the back of the DVD Player that send audio to another system (TV, Stereo, etc.).

Bit Rate: The amount of data used to hold a given length of music; measured in kilobits per second, or kbps. Or, the speed at which you record. Generally, the higher the bit rate, or the higher the recording speed, the better the sound quality. However, higher bit rates use more space on a Disc.

Chapter: Sections of a movie or a music piece on a DVD that are smaller than titles. A title is composed of several chapters. Each chapter is assigned a chapter number enabling you to locate the chapter you want.

Component Video Out Jacks: Red, blue and green jacks on the back of the DVD System that send high-quality video to a TV that has Component Video In jacks (R/G/B, Y/Pb/Pr, YUV, etc.).

Digital: Sound that has been converted into numerical values. Digital sound is available when you use the DIGITAL AUDIO OUT (COAXIAL or OPTICAL) jacks. These jacks send audio through multiple channels, instead of just two channels as analog does.

Disc menu: A screen display prepared for allowing selection of images, sounds, subtitles, multi-angles, etc recorded on a DVD.

Dolby Digital: A surround sound system developed by Dolby Laboratories containing up to six channels of digital audio (front left and right, surround left and right, center and subwoofer).

JPEG: A very common digital still picture format. A still-picture data compression system proposed by the Joint Photographic Expert Group, which features small decrease in image quality in spite of its high compression ratio.

MP3: A file format with a sound data compression system. "MP3" is the abbreviation of Motion Picture Experts Group 1 (or MPEG-1) Audio Layer 3. By using the MP3 format. One CD-R or CD-RW can contain about 10 times more data than a regular CD.

Multichannel: DVDs are formatted to have each sound track constitute one sound field. Multichannel refers to a structure of sound tracks having three or more channels.

Parental Control: Limits Disc play according to the age of the users or the limitation level in each country. The limitation varies from disc to disc; when it is activated, playback will be prohibited if the software's level is higher than the user-set level.

PCM (Pulse Code Modulation): A system for converting analog sound to digital sound for later processing, with no data compression used in conversion.

Playback control (PBC): Refers to the signal recorded on video CDs or SVCDs for controlling playback. By using menu screens recorded on a Video CD or SVCD that supports PBC, you can enjoy interactive playback and searching.

Progressive Scan: It displays all the horizontal lines of a picture at one time, as a single frame. This system can convert the interlaced video from DVD into progressive format when the DVD Player is connected to a Progressive Scan TV. It dramatically increases the vertical resolution and provides the best picture.

Region code: A system allowing discs to be played only in the region designated. This unit will only play discs that have compatible region codes. You can find the region code of your unit by looking on the product label. Some discs are compatible with more than one region (or ALL regions).

S-Video: Produces a clear picture by sending separate signals for the luminance and the color. You can use S-Video only if your TV has an S-Video In jack.

Title: The longest section of a movie or music feature on DVD. Each title is assigned a title number, enabling you to locate the title you want.

VIDEO OUT jack: Yellow jack on the back of the DVD Player that sends the DVD picture video to a TV.

PHILIPS CONSUMER ELECTRONICS COMPANY

A Division of Philips Electronics North America Corporation, Knoxville, Tennessee 37914-1810, USA

DVP 640 • DVP 642



8239 210 98531
IB8461E001

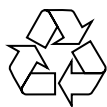

The products and services described herein are not necessarily available in all countries. Due to continuous product improvements this document is subject to change without notice.

Printed in China
SL-0347/17-1