

Register your product and get support at  
[www.philips.com/welcome](http://www.philips.com/welcome)

MCM103B



---

EN      User manual      3

---

**PHILIPS**



# Contents

---

<b>1 Important</b>	4
Safety	4
Notice	6

---

<b>2 Your Micro Hi-Fi System</b>	7
Introduction	7
What's in the box	7
Overview of the main unit	8
Overview of the remote control	9

---

<b>3 Connect</b>	10
Connect speakers	10
Connect power	11

---

<b>4 Get started</b>	11
Prepare the remote control	11
Auto install radio stations	12
Set clock	12
Turn on	12

---

<b>5 Play</b>	13
Play discs	13
Play from USB	13

---

<b>6 Play options</b>	13
Skip to a track	13
Pause/resume play	13
Search within a track	13
Display play information	13
Repeat play	13
Random play	14
Program tracks	14

---

<b>7 Adjust volume level and sound effect</b>	15
Adjust volume level	15
Select a preset sound effect	15
Enhance bass	15
Mute sound	15

---

<b>8 Listen to radio</b>	15
Tune to a radio station	15
Program radio stations automatically	15
Program radio stations manually	16
Select a preset radio station	16

---

<b>9 Other features</b>	17
Set the alarm timer	17
Set the sleep timer	17
Listen to an external device	17

---

<b>10 Product information</b>	18
Specifications	18
USB playability information	18
Supported MP3 disc formats	19

---

<b>11 Troubleshooting</b>	20
No sound or poor sound	20

# 1 Important

---

## Safety

### Know these safety symbols

This 'bolt of lightning' indicates uninsulated material within your unit may cause an electrical shock. For the safety of everyone in your household, please do not remove product covering.

The 'exclamation mark' calls attention to features for which you should read the enclosed literature closely to prevent operating and maintenance problems.  
**WARNING:** To reduce the risk of fire or electric shock, this apparatus should not be exposed to rain or moisture and objects filled with liquids, such as vases, should not be placed on this apparatus.

**CAUTION:** To prevent electric shock, fully insert the plug. (For regions with polarized plugs: To prevent electric shock, match wide blade to wide slot.)

---

### Important Safety Instructions

- ① Read these instructions.
  - ② Keep these instructions.
  - ③ Heed all warnings.
  - ④ Follow all instructions.
  - ⑤ Do not use this apparatus near water.
  - ⑥ Clean only with dry cloth.
  - ⑦ Do not block any ventilation openings. Install in accordance with the manufacturer's instructions.
  - ⑧ Do not install near any heat sources such as radiators, heat registers, stoves, or other apparatus (including amplifiers) that produce heat.
  - ⑨ Protect the power cord from being walked on or pinched, particularly at plugs, convenience receptacles, and the point where they exit from the apparatus.
  - ⑩ Only use attachments/accessories specified by the manufacturer.
  - ⑪ Use only with the cart, stand, tripod, bracket, or table specified by the manufacturer or sold with the apparatus. When a cart is used, use caution when moving the cart/apparatus combination to avoid injury from tip-over.
- 
- ⑫ Unplug this apparatus during lightning storms or when unused for long periods of time.
  - ⑬ Refer all servicing to qualified service personnel. Servicing is required when the apparatus has been damaged in any way, such as power-supply cord or plug is damaged, liquid has been spilled or objects have fallen into the apparatus, the apparatus has been exposed to rain or moisture, does not operate normally, or has been dropped.
  - ⑭ Battery usage **CAUTION** – To prevent battery leakage which may result in bodily injury, property damage, or damage to the unit:
    - Install all batteries correctly, + and - as marked on the unit.
    - Do not mix batteries (old and new or carbon and alkaline, etc.).
    - Remove batteries when the unit is not used for a long time.
    - Batteries (battery pack or batteries installed) shall not be exposed to excessive heat such as sunshine, fire or the like.

- ⑮ Apparatus shall not be exposed to dripping or splashing.
- ⑯ Do not place any sources of danger on the apparatus (e.g. liquid filled objects, lighted candles).
- ⑰ Where the MAINS plug or an appliance coupler is used as the disconnect device, the disconnect device shall remain readily operable.

 **Warning**

- Never remove the casing of this apparatus.
- Never lubricate any part of this apparatus.
- Never place this apparatus on other electrical equipment.
- Keep this apparatus away from direct sunlight, naked flames or heat.
- Never look into the laser beam inside this apparatus.
- Ensure that you always have easy access to the power cord, plug or adaptor to disconnect this apparatus from the power.

 **Caution**

- Use of controls or adjustments or performance of procedures other than herein may result in hazardous radiation exposure or other unsafe operation.

---

## Hearing safety

### Listen at a moderate volume.

- Using headphones at a high volume can impair your hearing. This product can produce sounds in decibel ranges that may cause hearing loss for a normal person, even for exposure less than a minute. The higher decibel ranges are offered for those that may have already experienced some hearing loss.

- Sound can be deceiving. Over time your hearing 'comfort level' adapts to higher volumes of sound. So after prolonged listening, what sounds 'normal' can actually be loud and harmful to your hearing. To guard against this, set your volume to a safe level before your hearing adapts and leave it there.

### To establish a safe volume level:

- Set your volume control at a low setting.
- Slowly increase the sound until you can hear it comfortably and clearly, without distortion.

### Listen for reasonable periods of time:

- Prolonged exposure to sound, even at normally 'safe' levels, can also cause hearing loss.
- Be sure to use your equipment reasonably and take appropriate breaks.

### Be sure to observe the following guidelines when using your headphones.

- Listen at reasonable volumes for reasonable periods of time.
- Be careful not to adjust the volume as your hearing adapts.
- Do not turn up the volume so high that you can't hear what's around you.
- You should use caution or temporarily discontinue use in potentially hazardous situations. Do not use headphones while operating a motorized vehicle, cycling, skateboarding, etc.; it may create a traffic hazard and is illegal in many areas.

---

## Notice

Any changes or modifications made to this device that are not expressly approved by Philips Consumer Lifestyle may void the user's authority to operate the equipment.



Your product is designed and manufactured with high quality materials and components, which can be recycled and reused.



When this crossed-out wheeled bin symbol is attached to a product it means that the product is covered by the European Directive 2002/96/EC.

Please inform yourself about the local separate collection system for electrical and electronic products.

Please act according to your local rules and do not dispose of your old products with your normal household waste. Correct disposal of your old product helps to prevent potential negative consequences for the environment and human health.



Your product contains batteries covered by the European Directive 2006/66/EC, which cannot be disposed with normal household waste. Please inform yourself about the local rules on separate collection of batteries because correct disposal helps to prevent negative consequences for the environmental and human health.

## Environmental information

All unnecessary packaging has been omitted. We have tried to make the packaging easy to separate into three materials: cardboard (box), polystyrene foam (buffer) and polyethylene (bags, protective foam sheet.)

Your system consists of materials which can be recycled and reused if disassembled by a specialized company. Please observe the local regulations regarding the disposal of packaging materials, exhausted batteries and old equipment.

**This apparatus includes this label:**



## 2 Your Micro Hi-Fi System

Congratulations on your purchase, and welcome to Philips! To fully benefit from the support that Philips offers, register your product at [www.Philips.com/welcome](http://www.Philips.com/welcome).

---

### Introduction

**With this unit, you can:**

- enjoy music from audio discs, USB devices and other external devices directly
- listen to FM radio stations

**You can enrich sound output with these sound effects:**

- Digital Sound Control (DSC)
- Dynamic Bass Boost (DBB)

**The unit supports these media formats:**



---

### What's in the box

Check and identify the contents of your package:

- Main unit
- Loudspeaker boxes x 2
- Power cord
- MP3 link cable x 1
- Remote control
- Quick start guide
- User manual

## Overview of the main unit

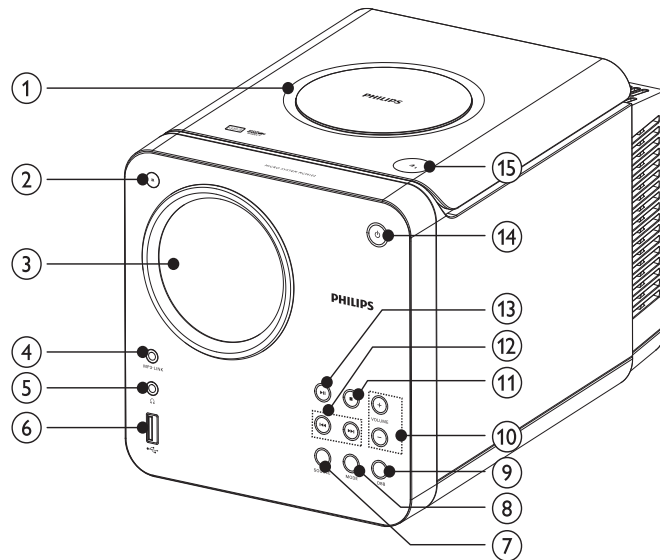

- |   |   |
|---|---|
| <p>① <b>Disc compartment</b></p> <p>② <b>IR</b></p> <ul style="list-style-type: none"> <li>• Remote control sensor</li> </ul> <p>③ <b>Display panel</b></p> <ul style="list-style-type: none"> <li>• Show current status.</li> </ul> <p>④ <b>MP3 LINK</b></p> <ul style="list-style-type: none"> <li>• Jack for an external audio device.</li> </ul> <p>⑤ <b>Headphone jack</b></p> <ul style="list-style-type: none"> <li>• Headphone jack</li> </ul> <p>⑥ <b>USB socket</b></p> <ul style="list-style-type: none"> <li>• USB socket</li> </ul> <p>⑦ <b>SOURCE</b></p> <ul style="list-style-type: none"> <li>• Select a source: Disc, USB, FM tuner, or MP3 link.</li> </ul> <p>⑧ <b>MODE</b></p> <ul style="list-style-type: none"> <li>• Select a repeat/shuffle play mode.</li> </ul> <p>⑨ <b>DBB</b></p> <ul style="list-style-type: none"> <li>• Turn on or off dynamic bass enhancement.</li> </ul> | <p>⑩ <b>VOLUME +/-</b></p> <ul style="list-style-type: none"> <li>• Adjust volume.</li> </ul> <p>⑪ <b>■</b></p> <ul style="list-style-type: none"> <li>• Stop play or erase a program.</li> </ul> <p>⑫ <b>⏮ / ⏭</b></p> <ul style="list-style-type: none"> <li>• Skip to the previous/next track.</li> <li>• Search fast forward or fast backward.</li> <li>• Tune to a radio station.</li> <li>• Adjust time.</li> </ul> <p>⑬ <b>▶   </b></p> <ul style="list-style-type: none"> <li>• Start or pause play.</li> </ul> <p>⑭ <b>⏻</b></p> <ul style="list-style-type: none"> <li>• Turn on the unit, or switch to standby mode, or switch to Eco Power standby.</li> </ul> <p>⑮ <b>▲</b></p> <ul style="list-style-type: none"> <li>• Open/close the disc compartment.</li> </ul> |
|---|---|



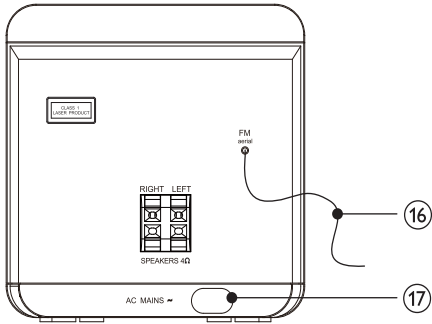

- ①⑥ FM antenna
  - Improve FM reception.
- ① AC MAINS~
  - Power cord socket

## Overview of the remote control

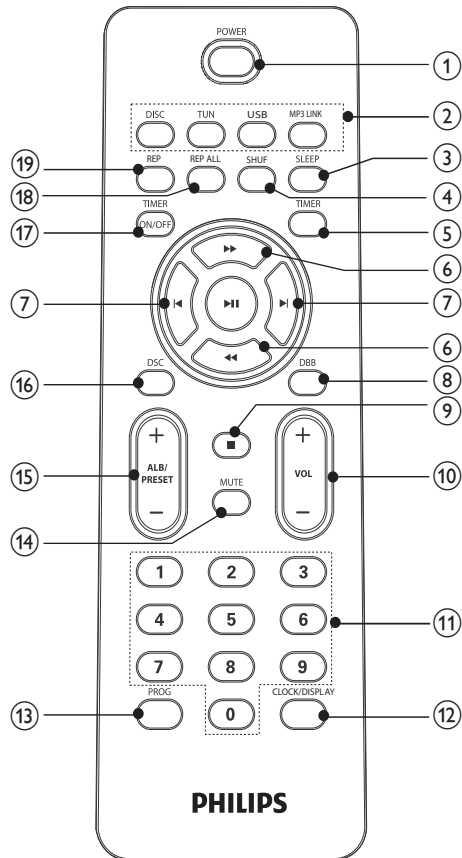

- ① POWER
  - Turn on the unit, or switch to standby mode.
- ② Source selection keys (DISC, TUN, USB, MP3 LINK)
  - Select a source: DISC, TUNER, USB or MP3 LINK.
- ③ SLEEP
  - Set the sleep timer.
- ④ SHUF
  - Play tracks randomly.

- ⑤ **TIMER**
  - Set the alarm timer.
- ⑥ **◀◀ / ▶▶**
  - Search within a track/ disc/USB.
  - Tune to a radio station.
  - Adjust time.
- ⑦ **◀ / ▶**
  - Skip to the previous/next track.
- ⑧ **DBB**
  - Turns on or off dynamic bass enhancement.
- ⑨ **■**
  - Stop play or erase a program.
- ⑩ **VOL +/-**
  - Adjust volume.
- ⑪ **Numeric keypad**
  - Select a track from a disc directly.
- ⑫ **CLOCK/DISPLAY**
  - Set the clock.
  - View the clock.
  - During play, select display information.
- ⑬ **PROG**
  - Program tracks.
  - Program radio stations.
  - Select 12 hour or 24 hour format.
- ⑭ **MUTE**
  - Mute volume.
- ⑮ **ALB/PRESET+/-**
  - Skip to the previous/next album.
  - Select a preset radio station.
- ⑯ **DSC**
  - Select a preset sound setting: POP, JAZZ, CLASSIC or ROCK.
- ⑰ **TIMER ON/OFF**
  - Turn on or off alarm timer.
- ⑱ **REP ALL**
  - Play all tracks repeatedly.
- ⑲ **REP**
  - Play a track repeatedly.

## 3 Connect

### Connect speakers

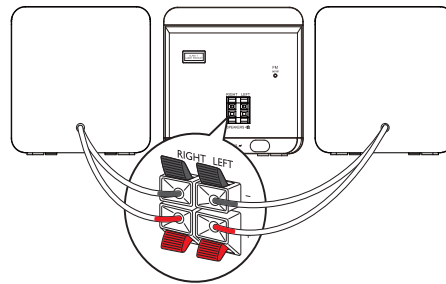

#### Note

- Ensure that the colors of the speaker wires and terminals are matched.

- 1 Hold down the socket flap.
- 2 Insert the stripped part of the wire completely.
  - Insert the right speaker wires to "RIGHT", left speaker wires to "LEFT".
  - Insert the red wires to "+", black wires to "-".
- 3 Release the socket flap.

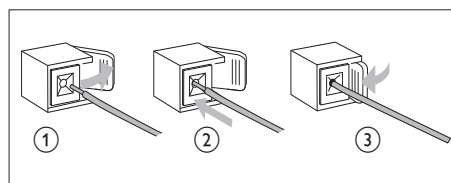

## Connect power

### ! Caution

- Risk of product damage! Ensure that the power supply voltage corresponds to the voltage printed on the back or the underside of the unit.
- Before connecting the AC power cord, ensure you have completed all other connections.

### ≡ Note

- The type plate is located on the rear of the main unit.
- The voltage selector is at the bottom of the main unit

- 1 Switch the voltage selector to the local power line voltage.
- 2 Connect the AC power cord to the **AC MAINS~** jack on the main unit and to the wall socket.

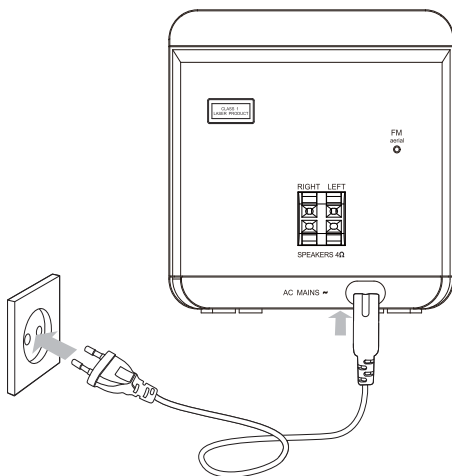

## 4 Get started

### ! Caution

- Use of controls or adjustments or performance of procedures other than herein may result in hazardous radiation exposure or other unsafe operation.

Always follow the instructions in this chapter in sequence.

If you contact Philips, you will be asked for the model and serial number of this apparatus. The model number and serial number are on the rear of the apparatus. Write the numbers here:  
 Model No. \_\_\_\_\_  
 Serial No. \_\_\_\_\_

## Prepare the remote control

### ! Caution

- Risk of explosion! Keep batteries away from heat, sunshine or fire. Never discard batteries in fire.

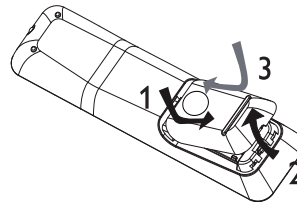

- 1 Open the battery compartment.
- 2 Insert 2 AAA batteries with correct polarity (+/-) as indicated.
- 3 Close the battery compartment.

### Note

- If you are not going to use the remote control for a long time, remove the batteries.
- Do not use old and new or different types of batteries in combination.
- Batteries contain chemical substances, so they should be disposed of properly.

---

## Auto install radio stations

When you connect the unit to the power supply for the first time, or no radio station is stored in this unit, Plug and Play is activated to store all available radio stations automatically.

- 1 Connect the unit to the power supply.
  - ↳ [AUTO INSTALL - PLEASE PRESS PLAY, STOP CANCEL] (press the PLAY button to auto install; to cancel, press ■) displays.
- 2 Press ►|| on the main unit to start installation.
  - ↳ [AUTO] displays.
  - ↳ The unit automatically store radio stations with sufficient signal strength.
  - ↳ When all the available radio stations are stored, the first preset radio station is broadcast automatically.

---

## Set clock

- 1 Press and hold **CLOCK/DISPLAY** to activate the clock setting mode.
  - ↳ The 12 hour or 24 hour format is displayed.
- 2 Press **PROG** repeatedly to select 12 hour or 24 hour format.
- 3 Press **CLOCK/DISPLAY** to confirm.
  - ↳ The hour digits are displayed and begin to blink.
- 4 Press ◀◀/▶▶ to set the hour.

- 5 Press **CLOCK/DISPLAY** to confirm.
  - ↳ The minute digits are displayed and begin to blink.

- 6 Press ◀◀/▶▶ to set the minute.

- 7 Press **CLOCK/DISPLAY** to confirm.

### Tip

- To view the clock during play, press **CLOCK/DISPLAY** repeatedly until the clock is displayed.

---

## Turn on

- 1 Press **POWER**.
  - ↳ The unit switches to the last selected source.

---

## Switch to standby

- 1 Press **POWER** to switch the unit to standby mode.
  - ↳ The backlight on the display panel is dimmed.
  - ↳ The clock (if set) appears on the display panel.

## 5 Play

### Play discs

- 1 Press **DISC** to select the disc source.
- 2 Press **▲** to open the disc compartment.
- 3 Insert a disc with the printed side facing up, then close the disc door.
  - ↳ Play starts automatically.

### Play from USB

#### Note

- Ensure that the USB device contains playable audio contents for supported formats.

- 1 Insert the USB plug of a USB device into  the socket.
- 2 Press **USB** to select the USB source.
  - ↳ The total number of tracks is displayed.
- 3 Press **ALB/PRESET+/-** to select a folder.
- 4 Press **◀/▶** to select a file.
- 5 Press **▶||** to start play.

## 6 Play options

### Skip to a track

For CD:

- 1 Press **◀/▶** to select another track.
  - To select a track directly, you can also press a key on the numerical keypad.

For MP3 disc and USB:

- 1 Press **ALB/PRESET+/-** to select an album or folder.
- 2 Press **◀/▶** to select select a track or file.

### Pause/resume play

- 1 During play, press **▶||** to pause/resume play.

### Search within a track

- 1 During play, press and hold **◀◀/▶▶**.
- 2 Release to resume normal play.

### Display play information

- 1 During play, press **CLOCK/DISPLAY** repeatedly to select different play information.

### Repeat play

#### Play a track repeatedly

- 1 During play, press **REP**.
  - ↳ **[REP]** (repeat) is displayed: the current track is played repeatedly.

- 2 To return to normal play, press **REP** again.

---

### Play all tracks or an album repeatedly

- 1 During play, press **REP ALL** repeatedly to select:
  - ↳ **[REP ALL]** (repeat all) is displayed: all tracks are played repeatedly.
  - ↳ **[REP ALB]** (repeat album) is displayed (for MP3 and USB only): the current album is played repeatedly.
- 2 To return to normal play, press **REP ALL** repeatedly until repeat mode is no longer displayed.

- 4 Repeat steps 2 to 3 to select and store all tracks to program.

- 5 Press **▶||** to play the programmed tracks.
  - ↳ During play, **[PROG]** (program) is displayed.
    - To erase the program, in the stop position, press **■**.

---

### Random play

- 1 Press **SHUF**.
  - ↳ **[SHUF]** (shuffle) is displayed: all tracks are played randomly.
- 2 To return to normal play, press **SHUF** again.



Tip

- The repeat and shuffle functions cannot be activated at the same time.

---

### Program tracks

You can program a maximum of 40 tracks.

- 1 At CD/USB mode, in the stop position, press **PROG** to activate the program mode.
  - ↳ **[PROG]** (program) blinks on the display.
- 2 For MP3 tracks, press **ALB/PRESET+/-** to select an album.
- 3 Press **◀/▶** to select a track number; then press **PROG** to confirm.

## 7 Adjust volume level and sound effect

### Adjust volume level

- 1 During play, press **VOL +/-** to increase/decrease the volume level.

### Select a preset sound effect

- 1 During play, press **DSC** repeatedly to select:
  - [POP] (pop)
  - [JAZZ] (jazz)
  - [ROCK] (rock)
  - [CLASSIC] (classic)

### Enhance bass

- 1 During play, press **DBB** to turn on or off dynamic bass enhancement.
  - ↳ If DBB is activated, DBB is displayed.

### Mute sound

- 1 During play, press **MUTE** to mute/unmute sound.

## 8 Listen to radio

### Tune to a radio station

- 1 Press **TUN** to select FM.
- 2 Press and hold **◀▶** for more than 2 seconds.
  - ↳ [SEARCH] (search) is displayed.
  - ↳ The radio tunes to a station with strong reception automatically.
- 3 Repeat step 2 to tune to more stations.
  - To tune to a weak station, press **◀▶** repeatedly until you find optimal reception.

### Program radio stations automatically



#### Note

- You can program a maximum of 20 preset radio stations.

- 1 In the tuner mode, press and hold **PROG** for 2 seconds to activate automatic program mode.
  - ↳ [AUTO] (auto) is displayed.
  - ↳ All available stations are programmed in the order of waveband reception strength.
  - ↳ The first programmed radio station is broadcast automatically.

---

## Program radio stations manually

 Note

- You can program a maximum of 20 preset radio stations.

- 1 Tune to a radio station.
- 2 Press **PROG** to activate program mode.  
↳ [PROG] (program) blinks on the display.
- 3 Press **ALB/PRESET+/-** to allocate a number (1 to 20) to this radio station, then press **PROG** to confirm.  
↳ The preset number and the frequency of the preset station are displayed.
- 4 Repeat the above steps to program other stations.

 Note

- To overwrite a programmed station, store another station in its place.

---

## Select a preset radio station

- 1 Press **ALB/PRESET+/-** to select a preset number.

 Tip

- FM antenna is fixed to the main unit.
- Position the antenna as far as possible from TV, VCR or other radiation source.
- For optimal reception, fully extend and adjust the position of the antenna.





## 9 Other features

### Set the alarm timer

This unit can be used as an alarm clock. The DISC, TUNER or USB is activated to play at a preset time.

- 1 Ensure that you have set the clock correctly.
- 2 Press and hold **TIMER**.
- 3 Press **DISC**, **TUN** or **USB** to select a source.
- 4 Press **TIMER** to confirm.
  - ↳ The hour digits are displayed and begin to blink.
- 5 Press **◀/▶** to set the hour.
- 6 Press **TIMER** to confirm.
  - ↳ The minute digits are displayed and begin to blink.
- 7 Press **◀/▶** to set the minute.
- 8 Press **TIMER** to confirm.
  - ↳ The timer is set and activated.

### Activate and deactivate alarm timer

- 1 Press **TIMER ON/OFF** repeatedly to activate or deactivate timer.
  - ↳ If timer is activated, the display shows .
  - ↳ If timer is deactivated,  disappears on the display.



#### Note

- Alarm timer is not available in MP3 LINK mode.
- If DISC/USB source is selected and the track cannot be played, tuner is activated automatically.

### Set the sleep timer

This unit can switch to standby automatically after a set period of time.

- 1 When the unit is turned on, press **SLEEP** repeatedly to select a set period of time (in minutes).
  - ↳ When sleep timer is activated, the display shows **zZ**.

#### To deactivate sleep timer

- 1 Press **SLEEP** repeatedly until **[OFF]** is displayed.
  - ↳ When sleep timer is deactivated, **zZ** disappears on the display.

### Listen to an external device

You can listen to an MP3 player through this unit.

- 1 Press **MP3 LINK** to select MP3 LINK source.
- 2 Connect the supplied MP3 link cable to:
  - **MP3 LINK** jack (3.5 mm) on the unit
  - the headphone jack on an external device
- 3 Start to play the device (see the device user manual).

# 10 Product information

## Note

- Product information is subject to change without prior notice.

## Specifications

### Amplifier

Rated Output Power	2X5W RMS
Frequency Response	60 - 16kHz, $\pm 3$ dB
Signal to Noise Ratio	>65dB
Aux Input	0.5 V RMS 20kohm

### Disc

Laser Type	Semiconductor
Disc Diameter	12cm/8cm
Support Disc	CD-DA, CD-R, CD-RW, MP3-CD
Audio DAC	24Bits / 44.1kHz
Total Harmonic Distortion	<1%
Frequency Response	60Hz -16kHz (44.1kHz)
S/N Ratio	>65dBA

### Tuner

Tuning Range	FM: 87.5 - 108 MHz
Tuning Grid	50 KHz
Sensitivity	
- Mono, 26 dB S/N Ratio	< 22 dBf
Search Selectivity	< 36 dBu
Total Harmonic Distortion	< 3%
Signal to Noise Ratio	> 45 dBu

### Speakers

Speaker Impedance	4ohm
Speaker Driver	3.5"woofer+0.8" tweeter
Sensitivity	>82dB/m/W

### General information

AC power	110-127/220-240V~; 50/60Hz
Operation Power Consumption	20 W
Standby Power Consumption	< 4 W
USB Direct	Version 2.0/1.1
Dimensions	
- Main Unit (W x H x D)	150 x 152 x 250 mm
- Speaker Box (W x H x D)	150 x 152 x 197 mm
Weight	
- Main Unit	2.002 kg
- Speaker Box	2 x 0.895 kg

---

## USB playability information

### Compatible USB devices:

- USB flash memory (USB 2.0 or USB1.1)
- USB flash players (USB 2.0 or USB1.1)
- memory cards (requires an additional card reader to work with this apparatus)

### Supported formats:

- USB or memory file format FAT12, FAT16, FAT32 (sector size: 512 bytes)
- MP3 bit rate (data rate): 32-320 Kbps and variable bit rate
- Directory nesting up to a maximum of 8 levels
- Number of albums/ folders: maximum 99
- Number of tracks/titles: maximum 999
- ID3 tag v2.0 or later
- File name in Unicode UTF8 (maximum length: 128 bytes)

### Unsupported formats:

- Empty albums: an empty album is an album that does not contain MP3 files, and is not be shown in the display.
- Unsupported file formats are skipped. For example, Word documents (.doc) or MP3 files with extension .dlf are ignored and not played.
- AAC, WAV, PCM audio files

---

## Supported MP3 disc formats

- ISO9660, Joliet
- Maximum title number: 512 (depending on file name length)
- Maximum album number: 255
- Supported sampling frequencies: 32 kHz, 44.1kHz, 48 kHz
- Supported Bit-rates: 32~256 (kbps), variable bit rates

# 11 Troubleshooting

## Warning

- Never remove the casing of this apparatus.

To keep the warranty valid, never try to repair the system yourself.

If you encounter problems when using this apparatus, check the following points before requesting service. If the problem remains unsolved, go to the Philips web site ([www.philips.com/welcome](http://www.philips.com/welcome)). When you contact Philips, ensure that the apparatus is nearby and the model number and serial number are available.

### No power

- Ensure that the AC power plug of the unit is connected properly.
- Ensure that there is power at the AC outlet.
- As a power-saving feature, the unit switches off automatically 15 minutes after track play reaches the end and no control is operated.

---

## No sound or poor sound

### No sound or poor sound

- Adjust the volume.
- Disconnect the headphones.
- Check that the speakers are connected correctly.
- Check if the stripped speaker wires are clamped.

### Left and right sound outputs reversed

- Check the speaker connections and location.

### No response from the apparatus

- Disconnect and reconnect the AC power plug, then turn on the system again.

- As a power-saving feature, the system switches off automatically 15 minutes after track play reaches the end and no control is operated.

### Remote control does not work

- Before you press any function button, first select the correct source with the remote control instead of the main unit.
- Reduce the distance between the remote control and the unit.
- Insert the battery with its polarities (+/- signs) aligned as indicated.
- Replace the battery.
- Aim the remote control directly at the sensor on the front of the unit.

### No disc detected

- Insert a disc.
- Check if the disc is inserted upside down.
- Wait until the moisture condensation at the lens has cleared.
- Replace or clean the disc.
- Use a finalized CD or correct format disc.

### Cannot display some files in USB device

- The number of folders or files in the USB device has exceeded a certain limit. This phenomenon is not a malfunction.
- The formats of these files are not supported.

### USB device not supported

- The USB device is incompatible with the unit. Try another one.

### Poor radio reception

- Increase the distance between the unit and your TV or VCR.
- Fully extend the FM antenna.

### Timer does not work

- Set the clock correctly.
- Switch on the timer.

### Clock/timer setting erased

- Power has been interrupted or the power cord has been disconnected.
- Reset the clock/timer.

