

# Always there to help you

Register your product and get support at  
[www.philips.com/welcome](http://www.philips.com/welcome)

HTB5510D  
HTB5540D  
HTB5570D



---

User manual

---

---

Manual del usuario

---

**PHILIPS**



- EN** Before using your product, read all accompanying safety information
- ES** Antes de usar el producto, consulte la información de seguridad que se encuentra adjunta.

\* **ES** Adaptador suministrado como accesorio. No debe ser utilizado en las redes eléctricas en Argentina, su uso está destinado sólo para los demás países de América Latina.



## HTB5510D

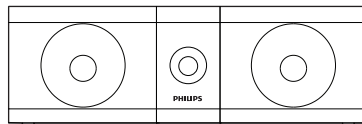
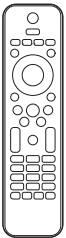

HDMI

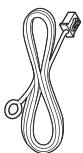

FM Antenna

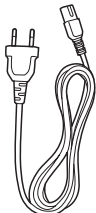

Power Cord

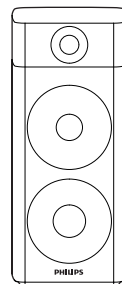
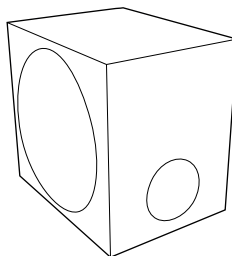

2x

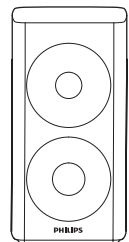

2x

## HTB5540D

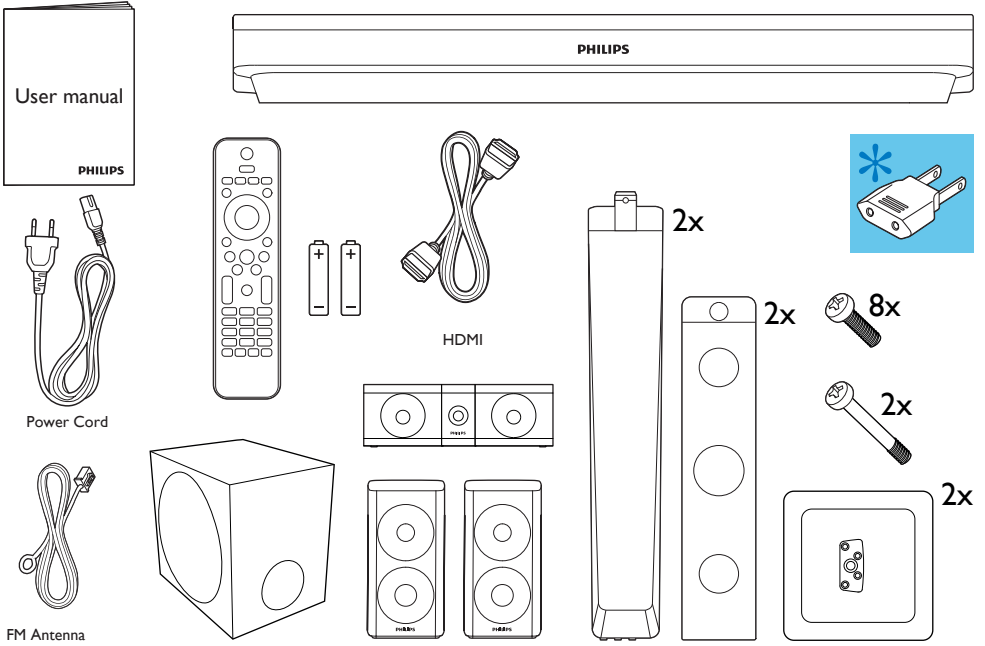

## HTB5570D

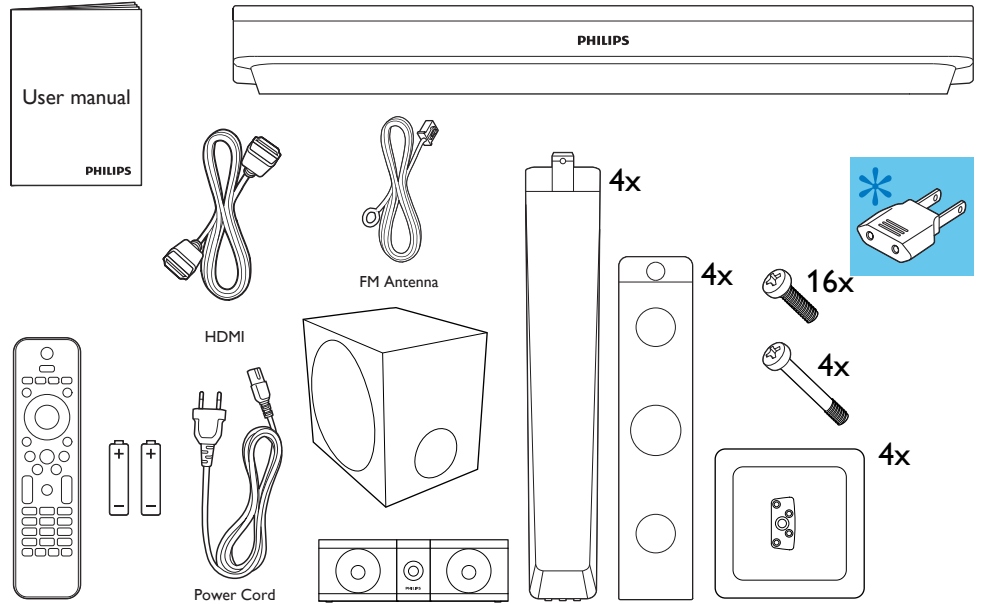

# 1

- EN** Stand mount the speakers  
Applied to HTB5540D and HTB5570D only
- ES** Montaje de los altavoces con base o soporte  
Solo aplica a los modelos HTB5540D y HTB5570D

## 1

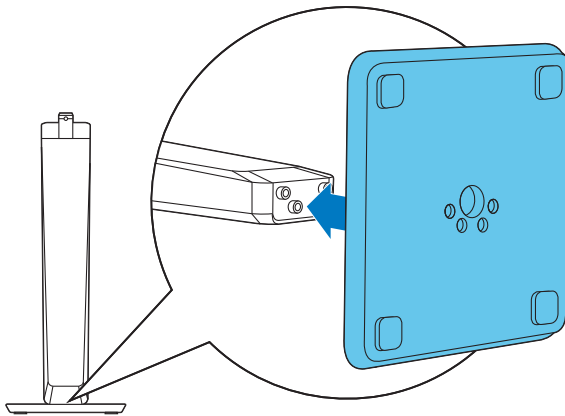

## 2

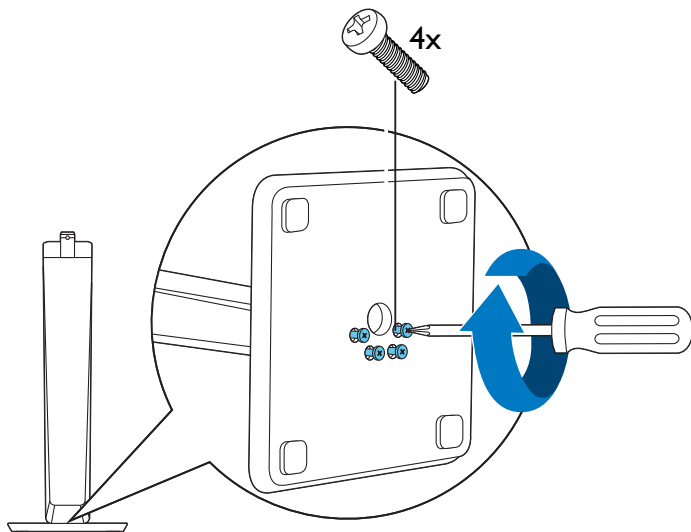

3

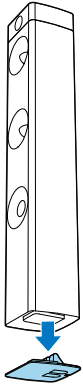

4

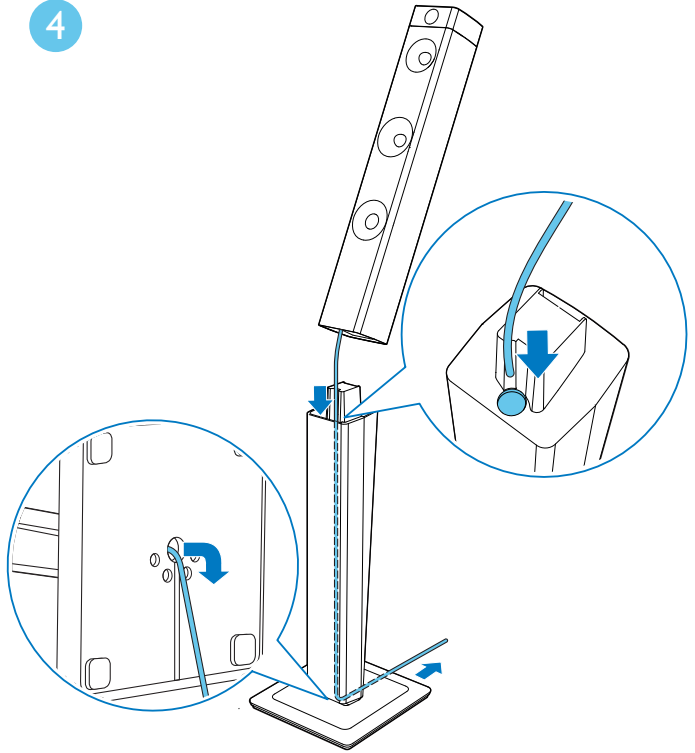

5

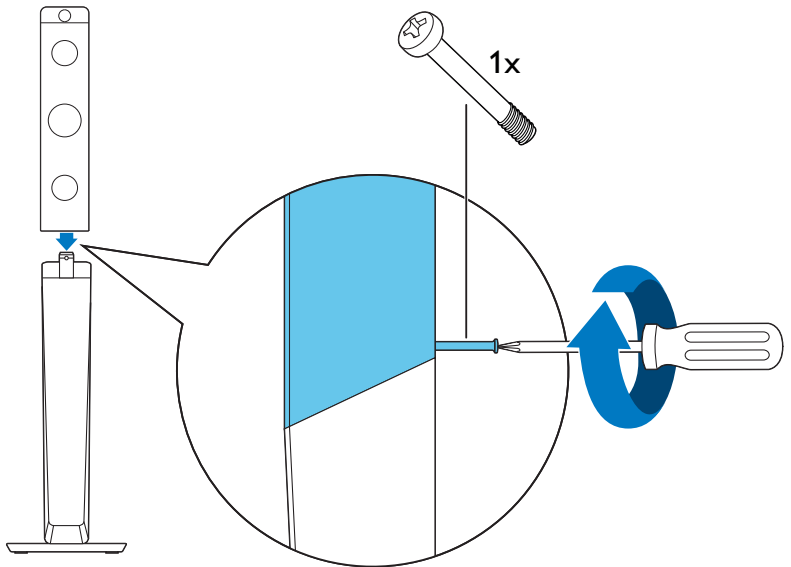

# 2

- EN Connect the home theater
- ES Conexión del Home Theater

## HTB5510D

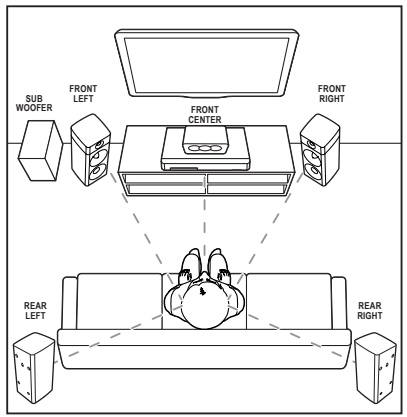
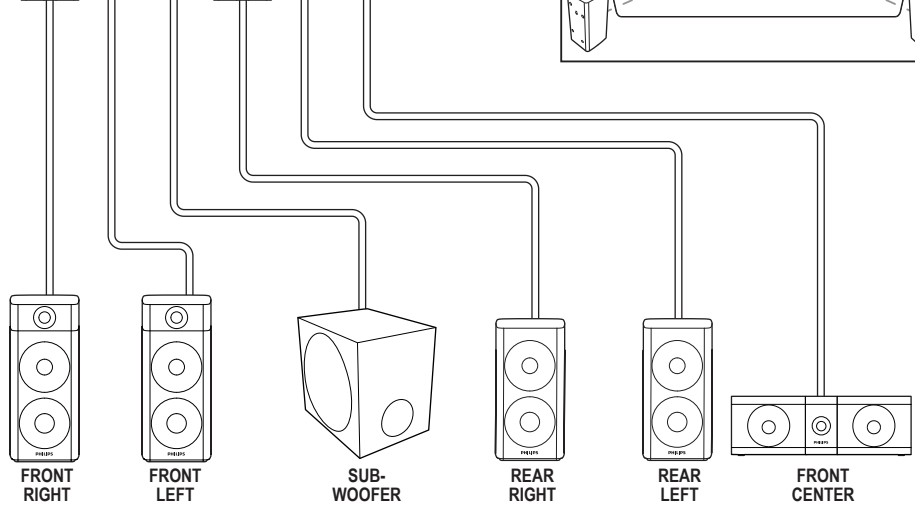
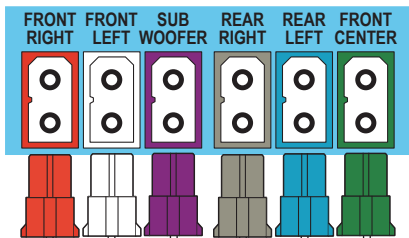
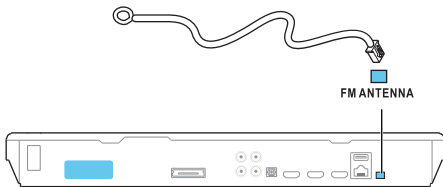

# HTB5540D

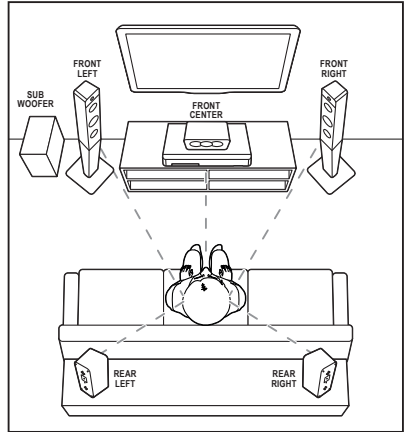
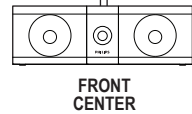
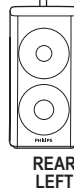
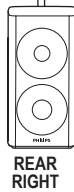
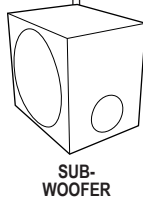
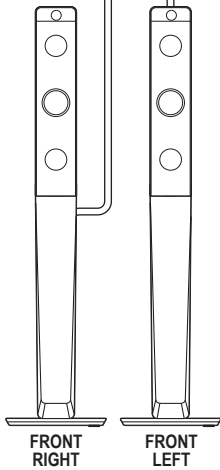
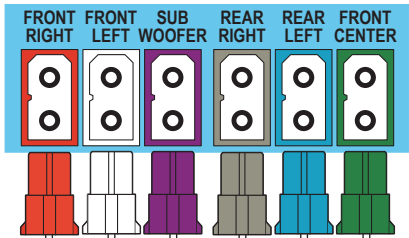

# HTB5570D

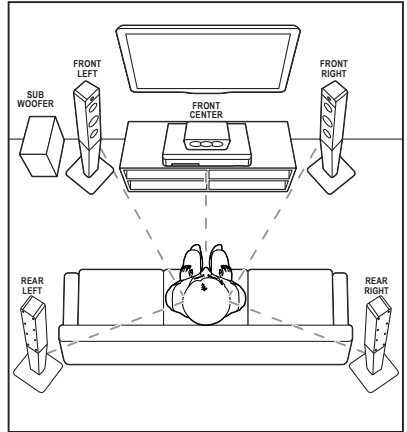
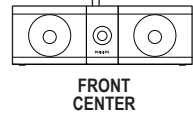
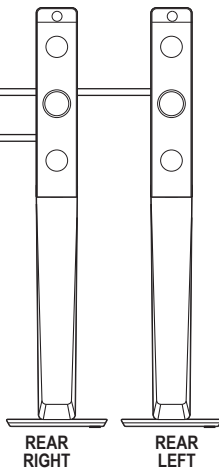
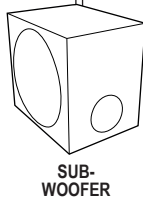
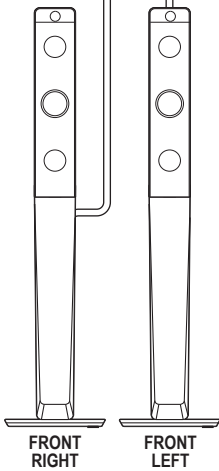
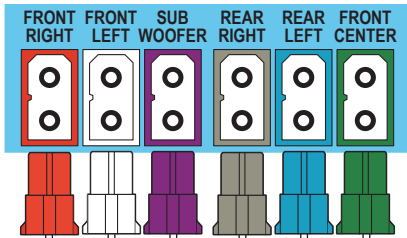



# 3

- EN** Connect to TV in one of these ways
- ES** Conecte al TV de alguna de las siguientes maneras

## HDMI ARC



## HDMI + OPTICAL

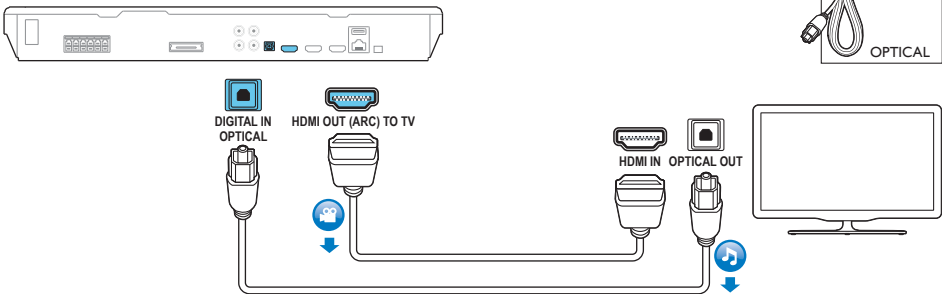

## HDMI + COAXIAL

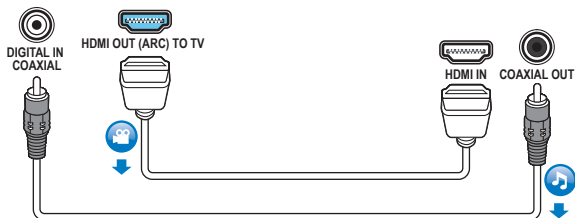

## HDMI + AUDIO L/R

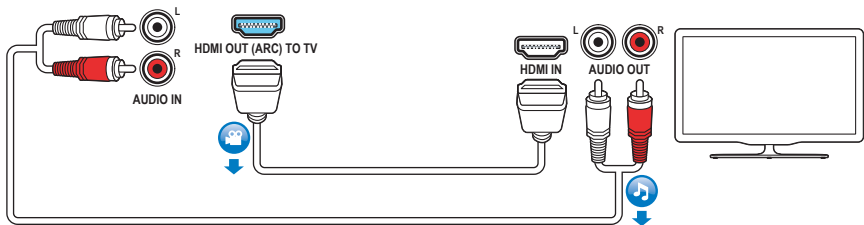

# 4

**EN** Connect with other HDMI devices

**ES** Conecte con otros dispositivos HDMI

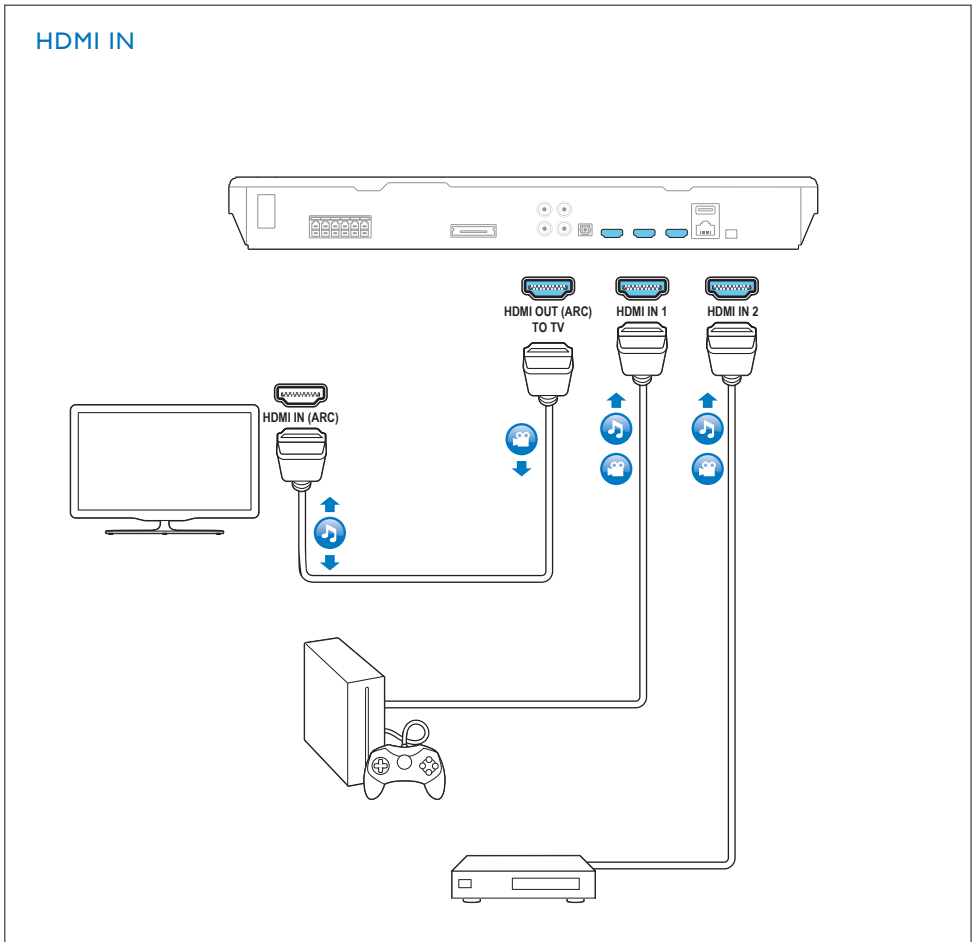

# 5

**EN** Switch on the home theater  
**ES** Encendido del Home Theater

1

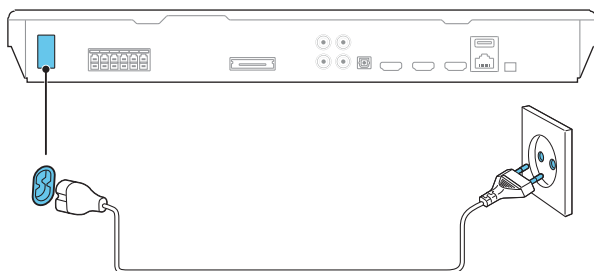

2

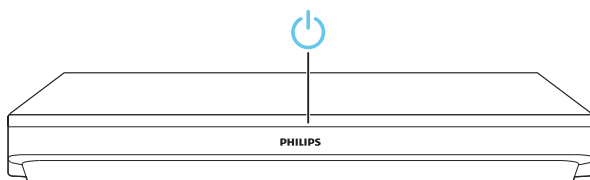

3

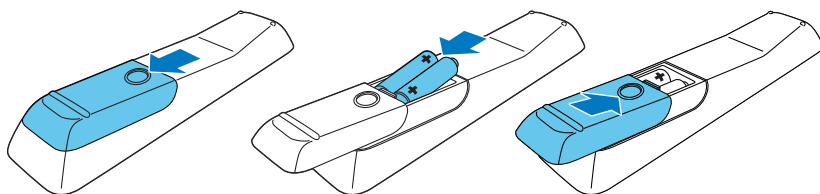

# 6

- EN Complete the first time setup
- ES Proceso de configuración inicial

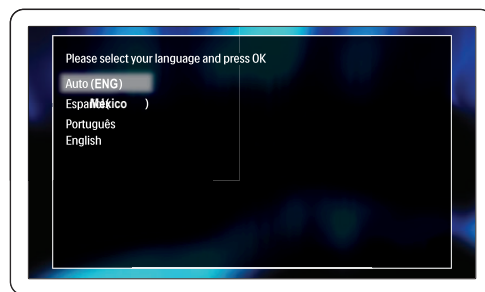
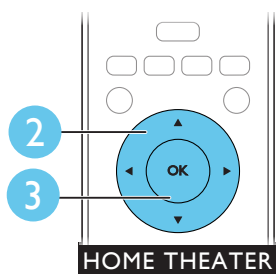
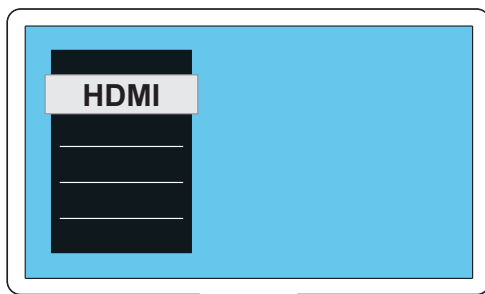
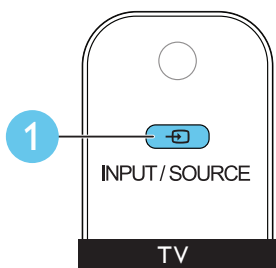

# 7

**EN** Use your home theater  
**ES** Uso del sistema de Home Theater

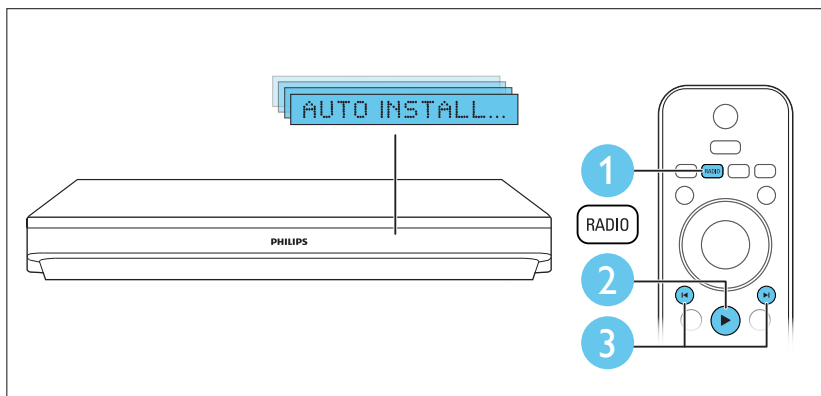
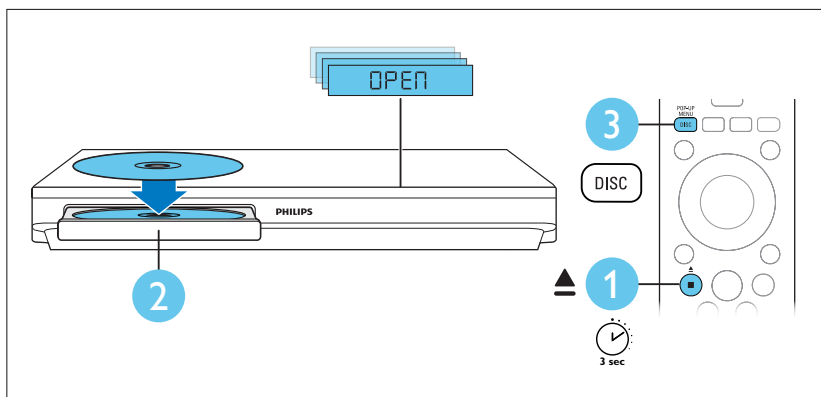

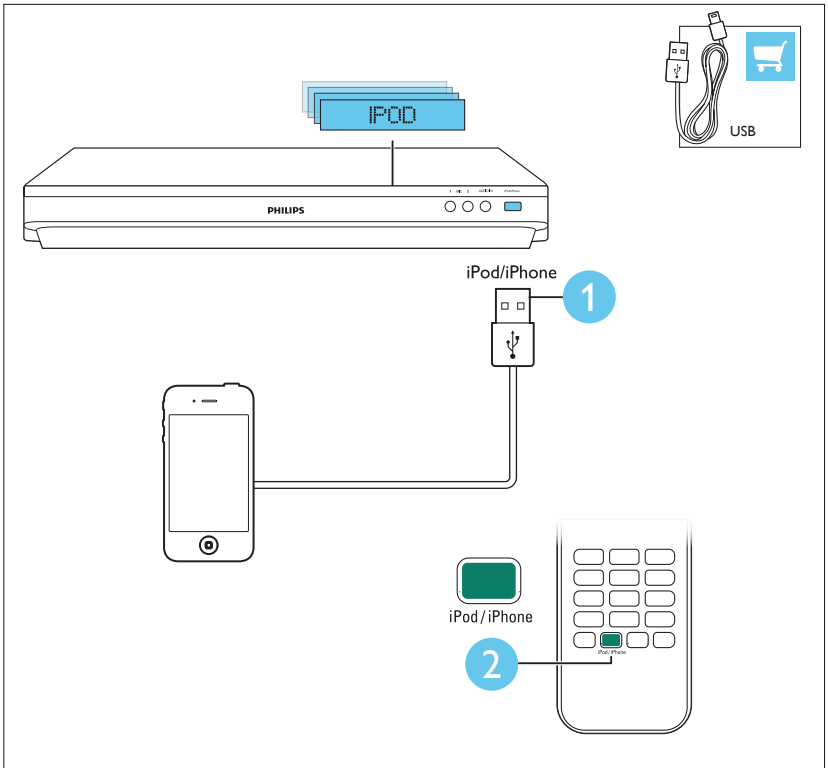
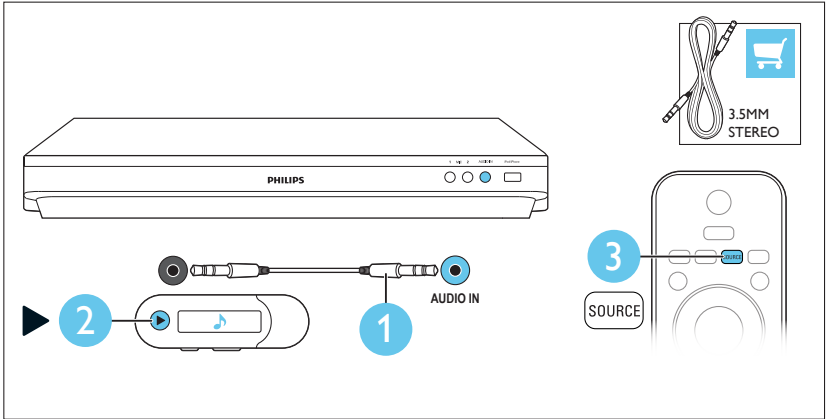

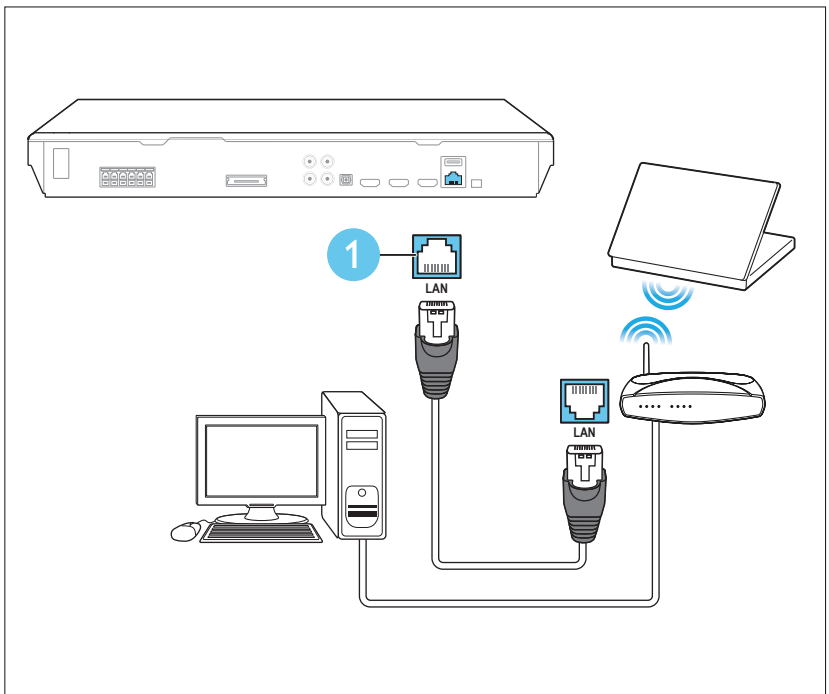
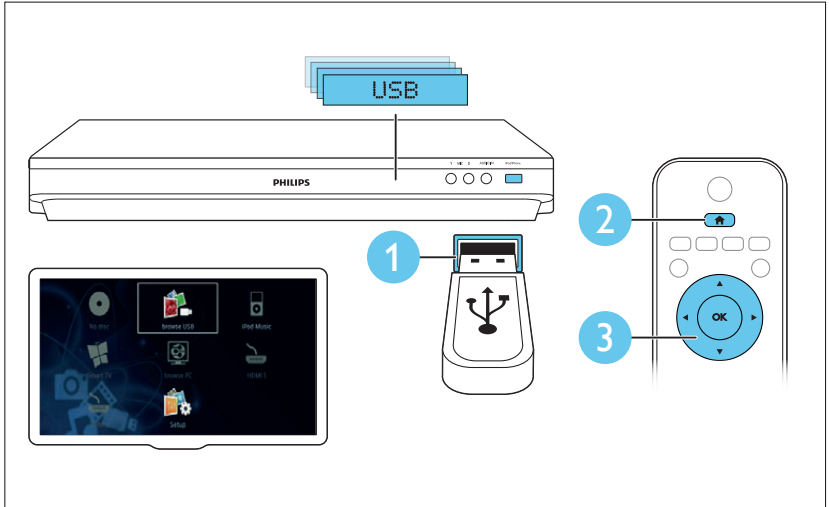



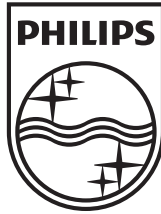

Specifications are subject to change without notice  
© 2013 Koninklijke Philips Electronics N.V.  
All rights reserved.

HTB5510D\_5540D\_5570D\_55\_UM\_V1.0

