

Register your product and get support at
www.philips.com/welcome

HTS3510

HTS3520



Quick Start

PHILIPS

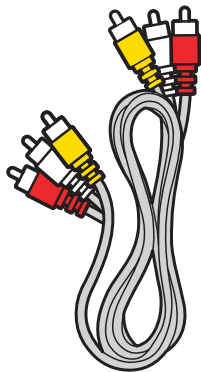
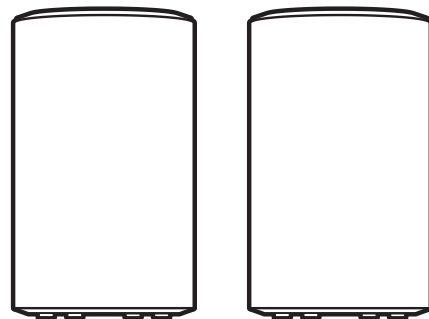
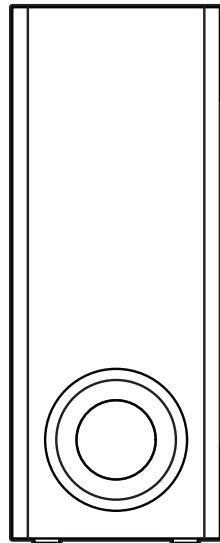
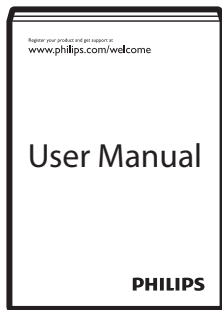
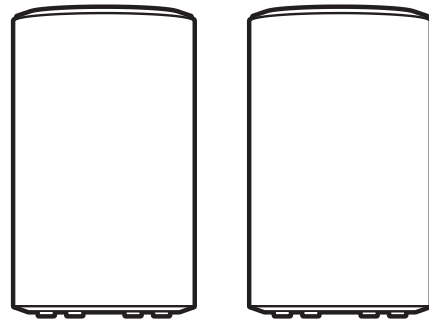
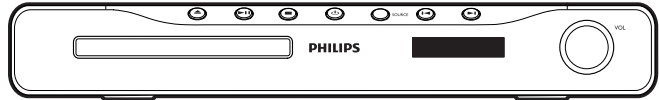
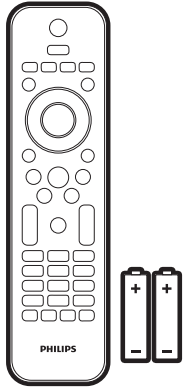
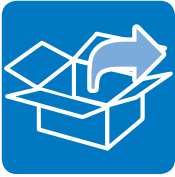

Audio/Video

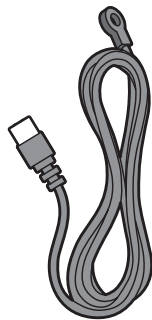

FM Antenna

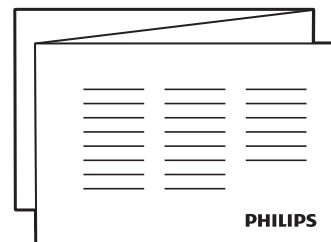

1

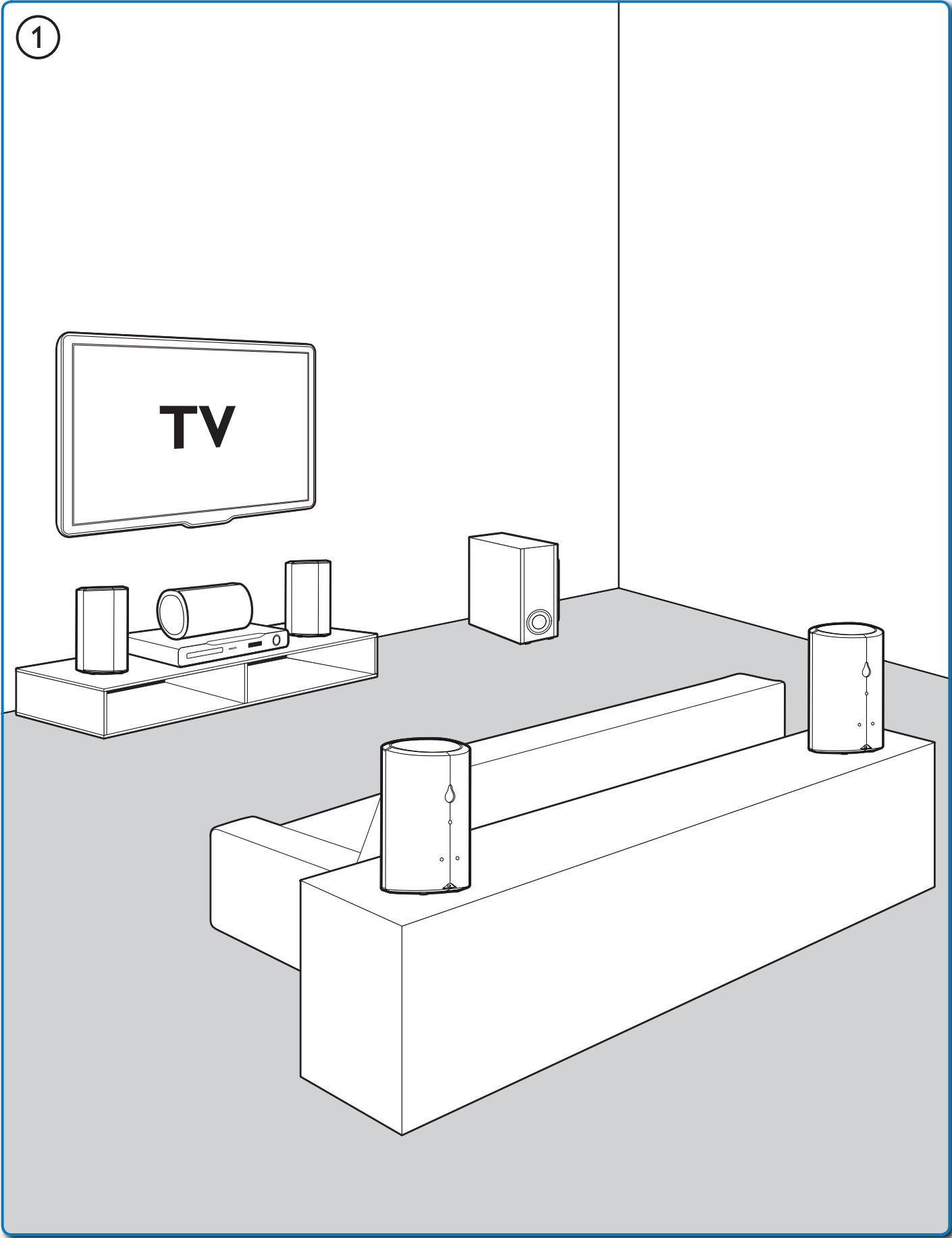

2

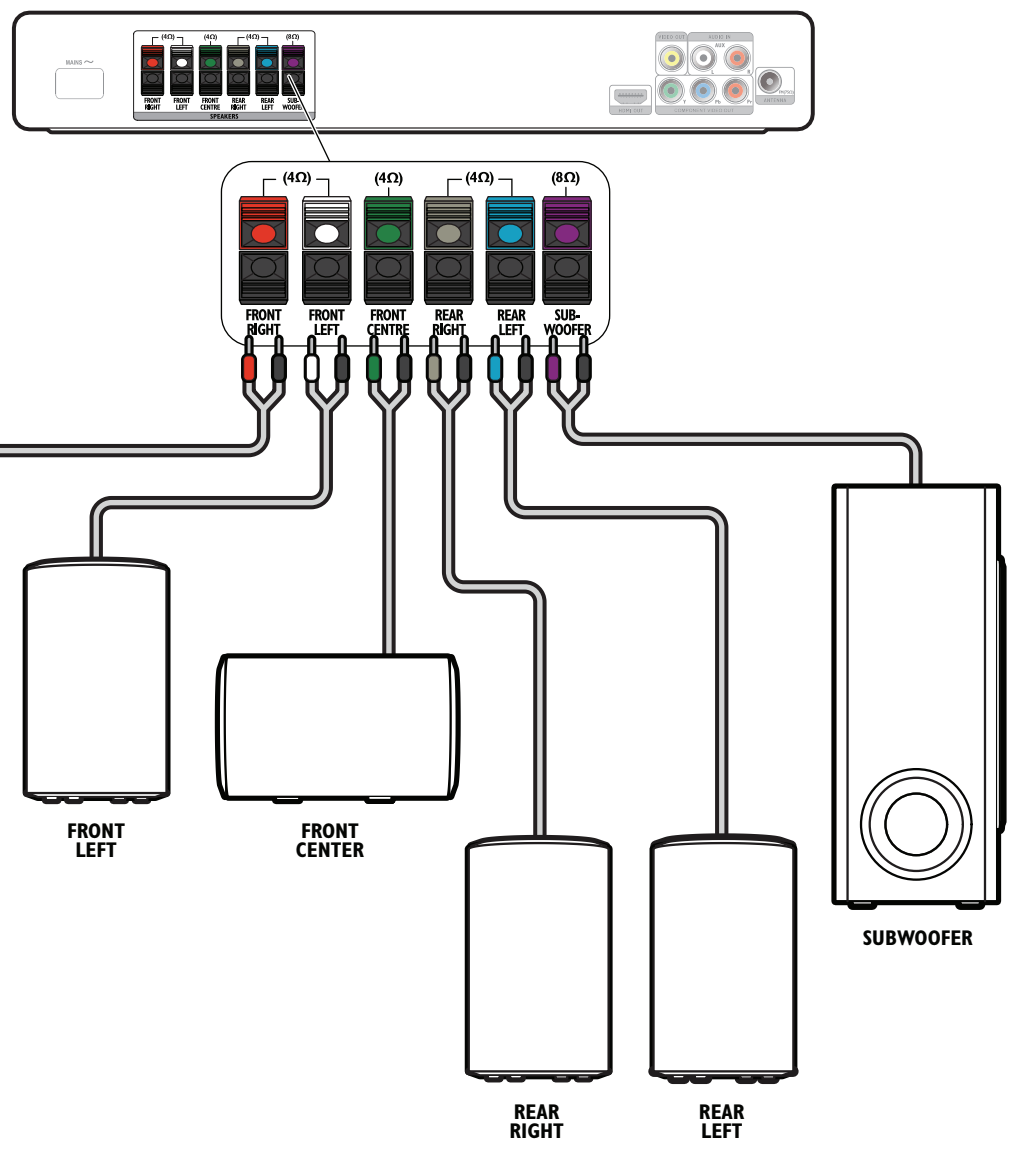

3

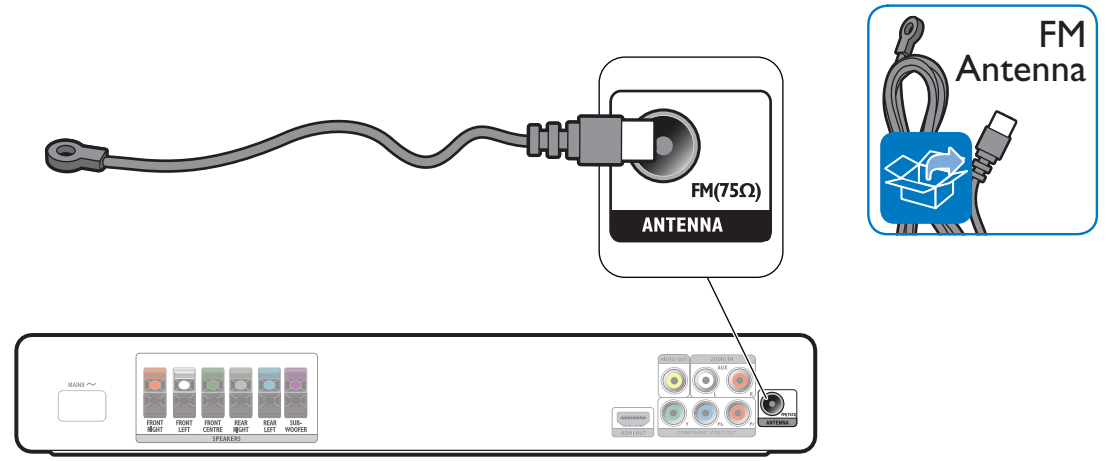

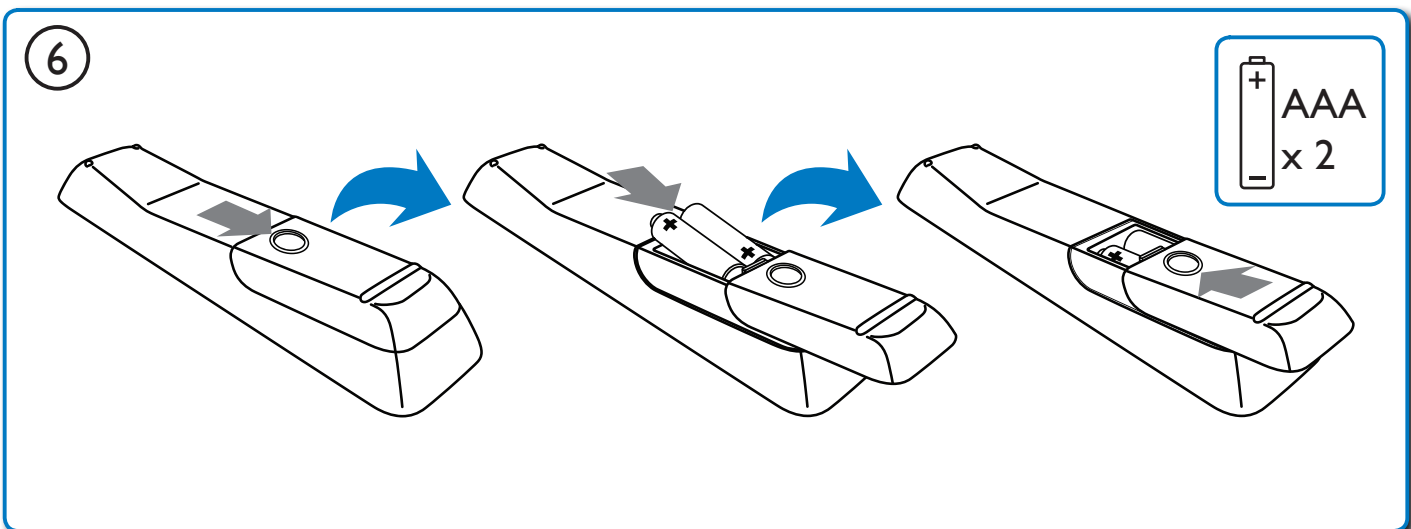
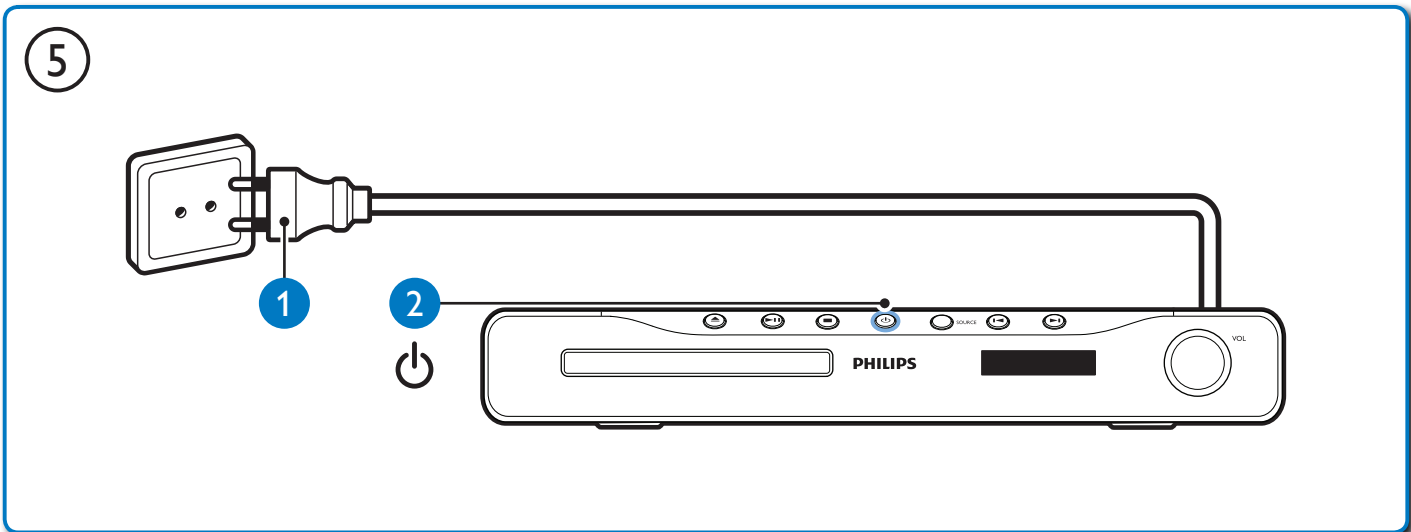
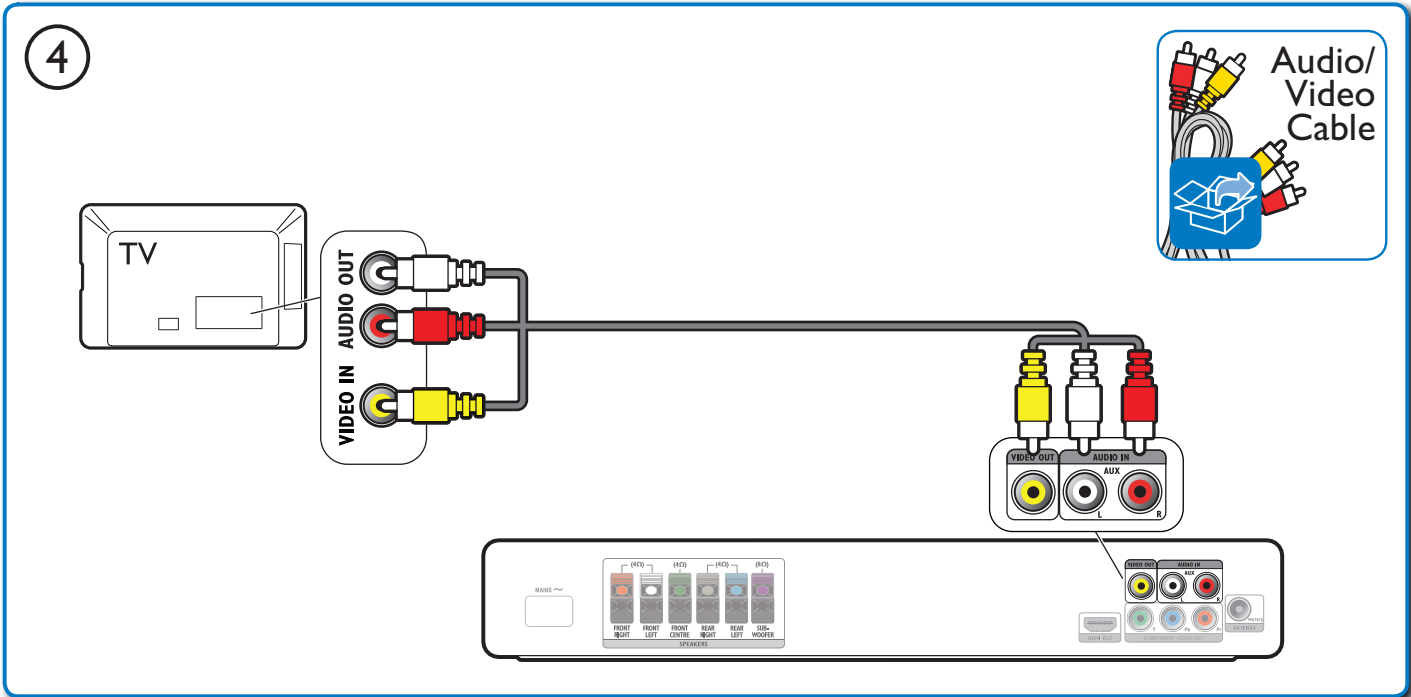

2

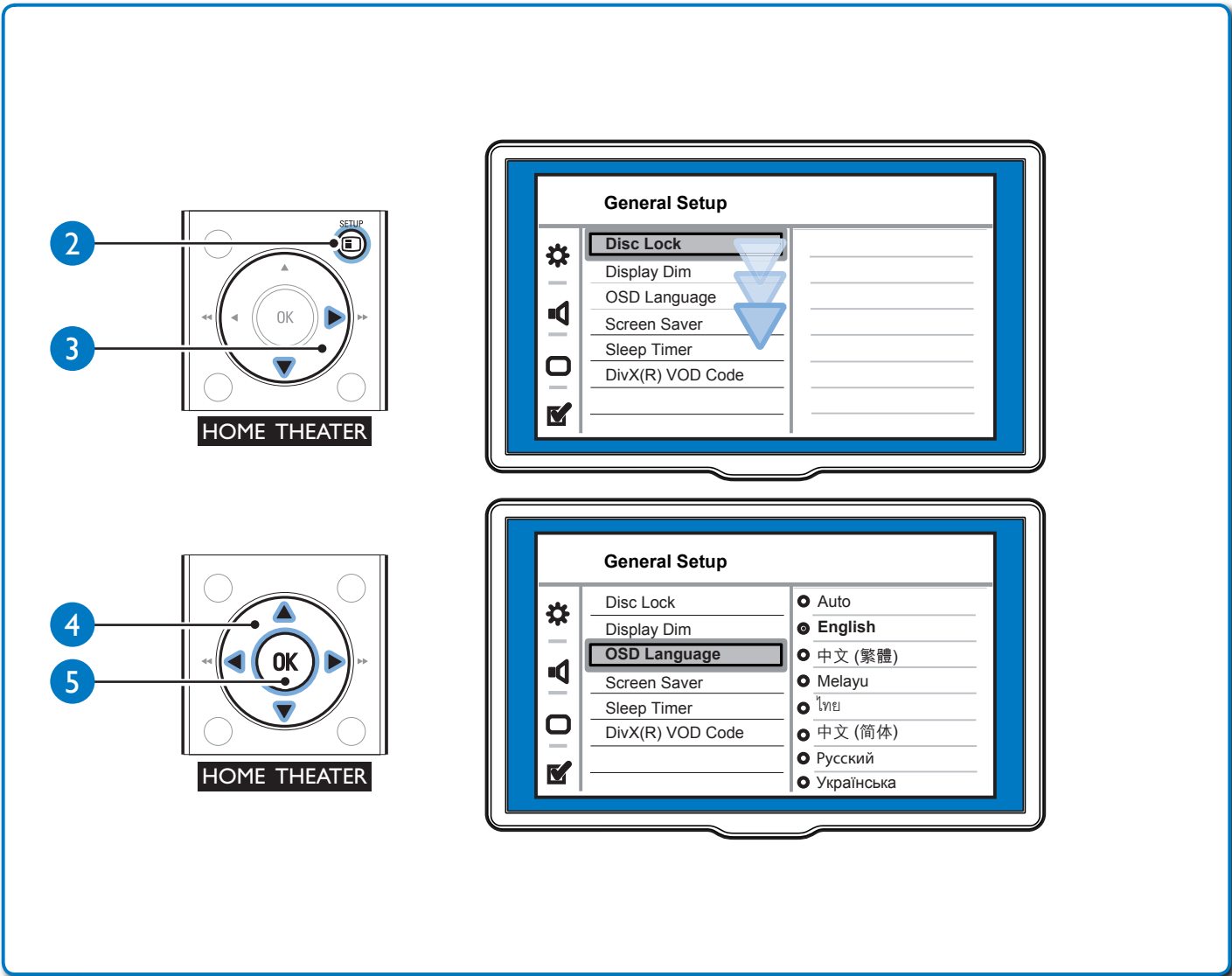
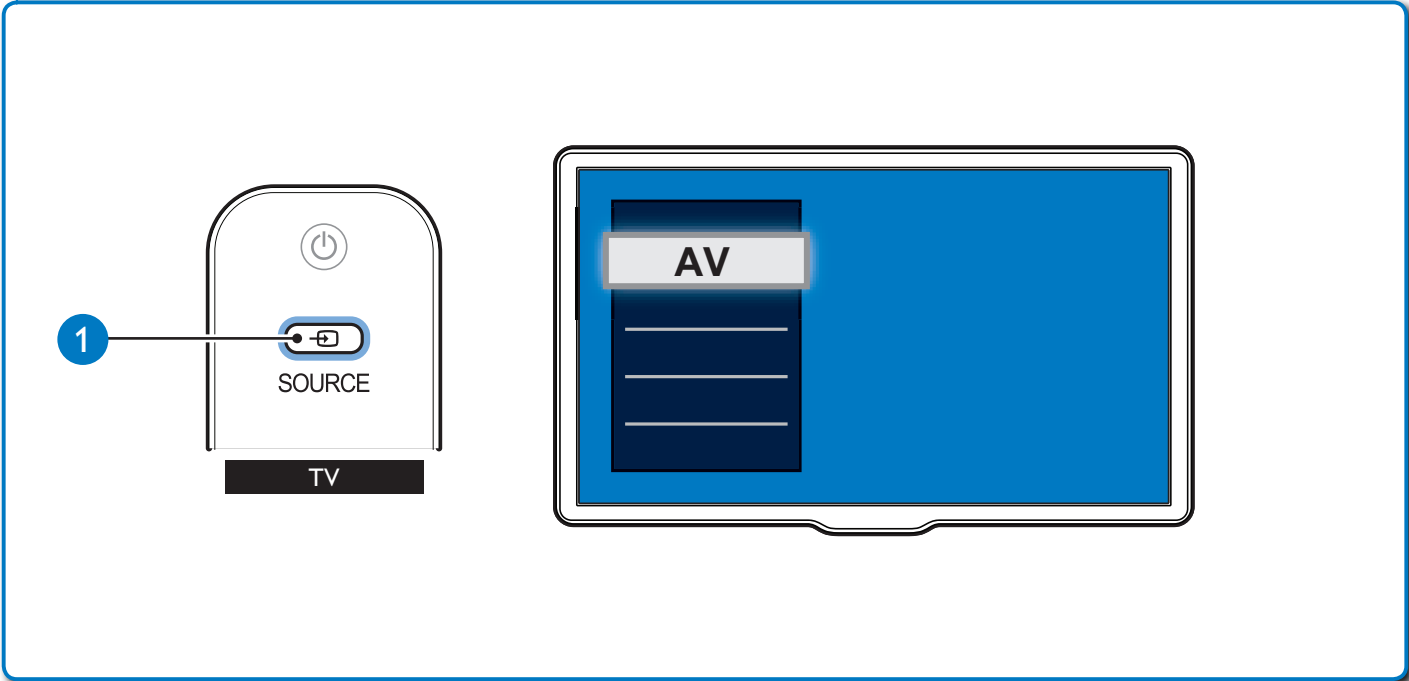

3

DISC

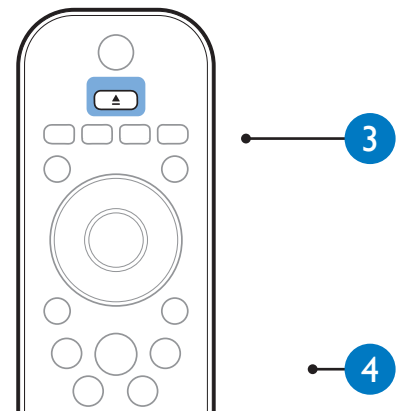
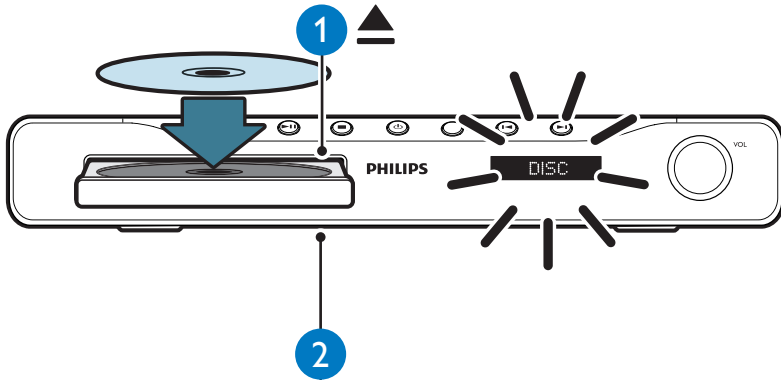

FM

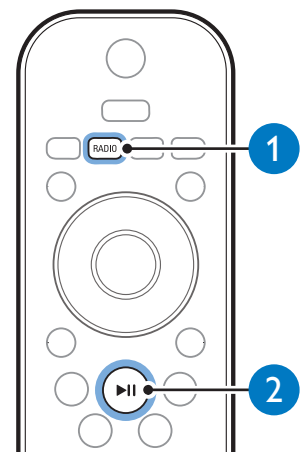
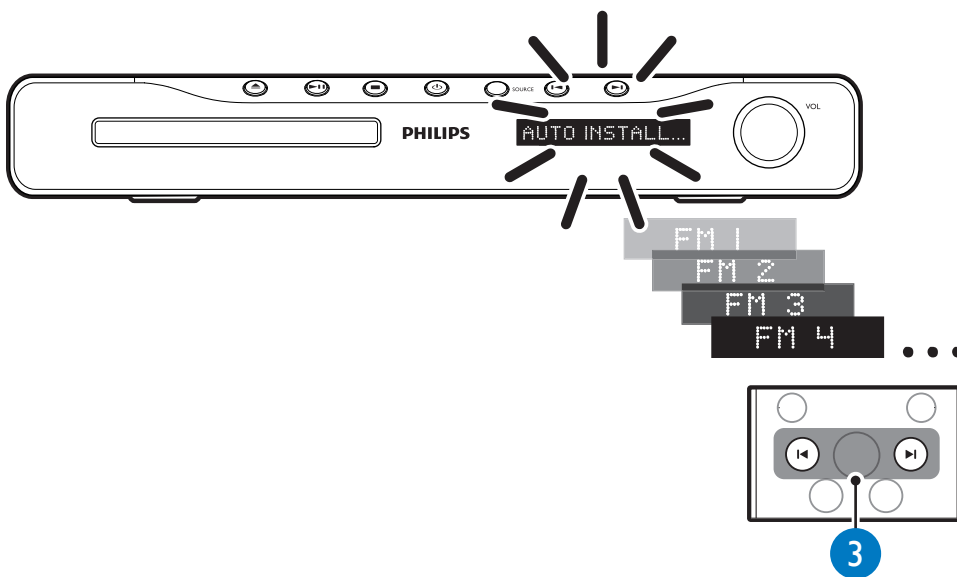

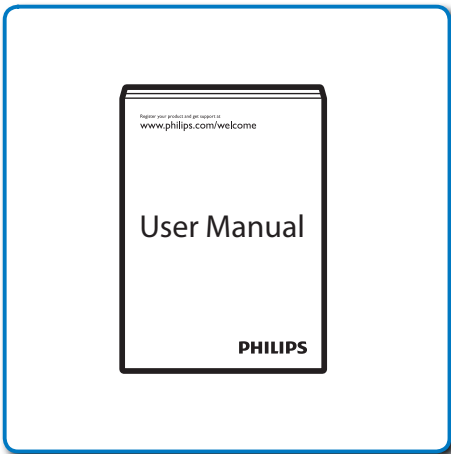
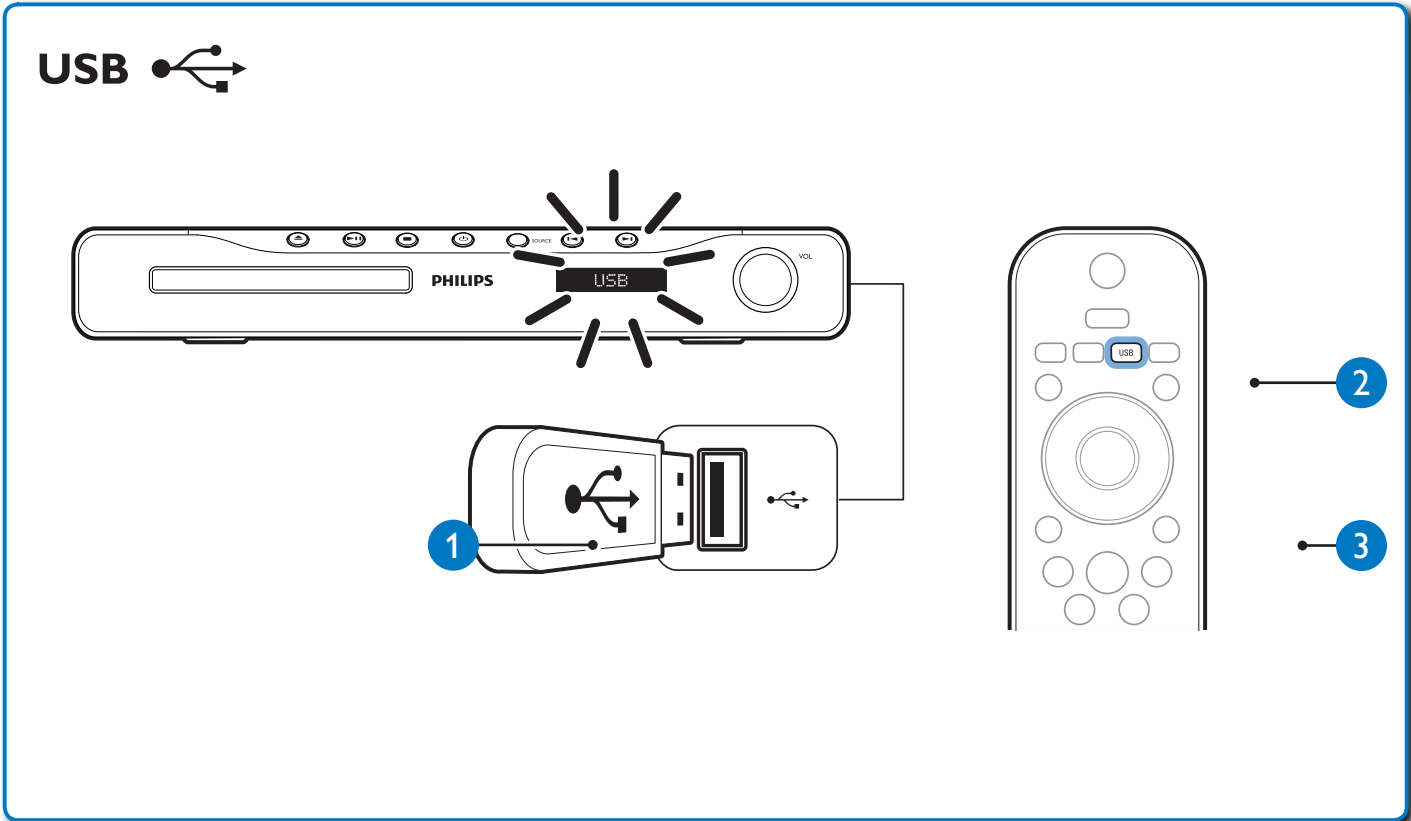

Specifications are subject to change without notice
Trademarks are the property of Koninklijke Philips Electronics N.V.
or their respective owners
2010 © Koninklijke Philips Electronics N.V. All rights reserved.
sgthy_1023/51.98_v3

 Be responsible
Respect copyrights

