

Register your product and get support at  
[www.philips.com/welcome](http://www.philips.com/welcome)

# PhotoFrame

SPF1017

SPF1027



---

EN

User manual

---

**PHILIPS**

# Contents

<b>1 Important</b>	<b>2</b>	<b>6 Setup</b>	<b>16</b>
Safety	2	Select an on-screen language	16
Safety precautions and maintenance	2	Select a slideshow transition effect	16
Notice	2	Select a slideshow frequency	17
Declaration of Conformity	2	Display collage photos	17
End of life disposal	2	Select a photo background	18
Recycling Information for Customers	3	Adjust display brightness	18
Compliance with Electro-Magnetic Field (EMF)	3	Select a slideshow sequence	19
Recycling	3	Protect/Unprotect content of a memory card	20
North Europe Information (Nordic Countries)	4	Set display auto on/off	20
Banned Substance Declaration	4	View the status of the PhotoFrame	21
		Set auto orientation	21
		Set button sound	22
		Display key hints at power on	22
		Set to factory default	23
<b>2 Your PhotoFrame</b>	<b>5</b>	<b>7 Product information</b>	<b>24</b>
Introduction	5	<b>8 Frequently asked questions</b>	<b>25</b>
What's in the box	5	<b>9 Glossary</b>	<b>26</b>
Overview of your PhotoFrame	6		
<b>3 Get started</b>	<b>7</b>		
Install the stand	7		
Connect power	7		
Turn on the PhotoFrame	7		
Connect a storage device	8		
Connect a PC/Mac	8		
<b>4 Photo</b>	<b>10</b>		
Play photos	10		
Manage photos/slideshow	10		
Copy a photo	10		
Delete a photo	11		
Select a photo effect	11		
Select a photo frame	11		
Rotate a photo	12		
Zoom and crop a photo	12		
Select slideshow sequence	12		
Select slideshow frequency	13		
<b>5 Clock</b>	<b>14</b>		
Set time and date	14		
Show clock in slideshow	14		
Set alarm clock	14		

## Need help?

Please visit [www.philips.com/welcome](http://www.philips.com/welcome) where you can access a full set of supporting materials such as user manual, the latest software updates and answers to frequently asked questions.

# 1 Important

---

## Safety

---

### Safety precautions and maintenance

- Never touch, push, rub or strike the screen with hard objects as this may damage the screen permanently.
- When the product is not used for long periods, unplug it.
- Before you clean the screen, turn off and unplug the power cord. Only clean the screen with a soft, water-damp cloth. Never use substances such as alcohol, chemicals or household cleaners to clean the product.
- Never place the product near naked flames or other heat sources, including direct sunlight.
- Never expose the product to rain or water. Never place liquid containers, such as vases, near the product.
- Never drop the product. When you drop the product, it will be damaged.
- Keep the stand away from cables.
- Ensure that you install and use services or software only from trustworthy sources free of virus or harmful software.
- This product is designed for indoor use only.
- Only use the supplied power adaptor for the product.

---

## Notice

### Warranty

No components are user serviceable. Do not open or remove covers to the inside of the product. Repairs may only be done by Philips Service Centres and official repair shops. Failure to do so shall void any warranty, stated or implied.

Any operation expressly prohibited in this manual, any adjustments, or assembly procedures not recommended or authorised in this manual shall void the warranty.



Be responsible  
Respect copyrights

The making of unauthorized copies of copy-protected material, including computer programs, files, broadcasts and sound recordings, may be an infringement of copyrights and constitute a criminal offence. This equipment should not be used for such purposes.

---

## Declaration of Conformity

Philips Consumer Lifestyle declares under our responsibility that the product is in conformity with the following standards  
EN60950-1:2006 (Safety requirement of Information Technology Equipment)  
EN55022:2006 (Radio Disturbance requirement of Information Technology Equipment)  
EN55024:1998 (Immunity requirement of Information Technology Equipment)  
EN61000-3-2:2006 (Limits for Harmonic Current Emission)  
EN61000-3-3:1995 (Limitation of Voltage Fluctuation and Flicker)  
following provisions of directives applicable  
73/23/EEC (Low Voltage Directive)  
2004/108/EC (EMC Directive)  
2006/95/EC (Amendment of EMC and Low Voltage Directive) and is produced by a manufacturing organization on ISO9000 level.

---

## End of life disposal

- Your new product contains materials that can be recycled and reused. Specialized companies can recycle your product to increase the amount of reusable materials and to minimize the amount to be disposed of.

- Please find out about the local regulations on how to dispose of your old monitor from your local Philips dealer.
- (For customers in Canada and U.S.A.) Dispose of in accordance to local-state and federal regulations.

For additional information on recycling contact [www.eia.org](http://www.eia.org) (Consumer Education Initiative).

## Recycling Information for Customers

Philips establishes technically and economically viable objectives to optimize the environmental performance of the organization's product, service and activities.

From the planning, design and production stages, Philips emphasizes the important of making products that can easily be recycled. At Philips, end-of-life management primarily entails participation in national take-back initiatives and recycling programs whenever possible, preferably in cooperation with competitors. There is currently a system of recycling up and running in the European countries, such as The Netherlands, Belgium, Norway, Sweden and Denmark.

In U.S.A., Philips Consumer Lifestyle North America has contributed funds for the Electronic Industries Alliance (EIA) Electronics Recycling Project and state recycling initiatives for end-of-life electronics products from household sources. In addition, the Northeast Recycling Council (NERC) - a multi-state non-profit organization focused on promoting recycling market development - plans to implement a recycling program.

In Asia Pacific, Taiwan, the products can be taken back by Environment Protection Administration (EPA) to follow the IT product recycling management process, detail can be found in web site [www.epa.gov.tw](http://www.epa.gov.tw). For help and service, please read the section of Service and Warranty or the following team of Environmental specialist can help.

## Compliance with Electro-Magnetic Field (EMF)

Koninklijke Philips Electronics N.V. manufactures and sells many products targeted at consumers, which, like any electronic apparatus, in general have the ability to emit and receive electromagnetic signals.

One of Philips' leading Business Principles is to take all necessary health and safety measures for our products, to comply with all applicable legal requirements and to stay well within the EMF standards applicable at the time of producing the products.

Philips is committed to develop, produce and market products that cause no adverse health effects. Philips confirms that if its products are handled properly for their intended use, they are safe to use according to scientific evidence available today.

Philips plays an active role in the development of international EMF and safety standards, enabling Philips to anticipate further developments in standardisation for early integration in its products.

## Recycling



Your product is designed and manufactured with high quality materials and components, which can be recycled and reused.

When you see the crossed-out wheel bin symbol attached to a product, it means the product is covered by the European Directive 2002/96/EC:



Never dispose of your product with other household waste. Please inform yourself about the local rules on the separate collection of electrical and electronic products. The correct disposal of your old product helps prevent potentially negative consequences on the environment and human health.

---

## North Europe Information (Nordic Countries)

### **VARNING:**

FÖRSÄKRA DIG OM ATT HUVUDBRYTARE OCH UTTAG ÄR LÄTÅTKOMLIGA, NÄR DU STÄLLER DIN UTRUSTNING PÅPLATS.

Placering/Ventilation

### **ADVARSEL:**

SØRG VED PLACERINGEN FOR, AT NETLEDNINGENS STIK OG STIKKONTAKT ER NEMT TILGÆNGELIGE.

Paikka/Ilmankierto

### **VAROITUS:**

SIIJOITA LAITE SITEN, ETTÄ VERKKOJOHTO VOIDAAN TARVITTAESSA HELPOSTI IRROTTAA PISTORASIESTA.

Plassering/Ventilasjon

### **ADVARSEL:**

NÅR DETTE UTSTYRET PLASSERES, MÅ DU PASSE PÅ AT KONTAKTENE FOR STØMTILFØRSEL ER LETTE Å NÅ.

---

## Banned Substance Declaration

This product complies with RoHs and Philips BSD (AR17-G04-5010-010) requirements.

## 2 Your PhotoFrame

Congratulations on your purchase, and welcome to Philips! To fully benefit from the support that Philips offers, register your product at [www.philips.com/welcome](http://www.philips.com/welcome).

### Introduction

With Philips Digital PhotoFrame, you can display JPEG photos in high quality directly from your memories cards.

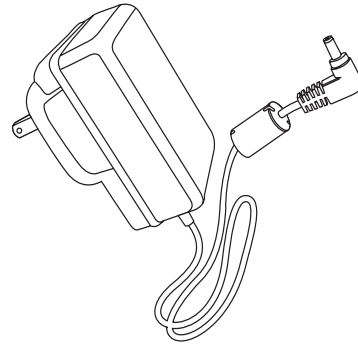

- AC-DC power adaptor

### What's in the box

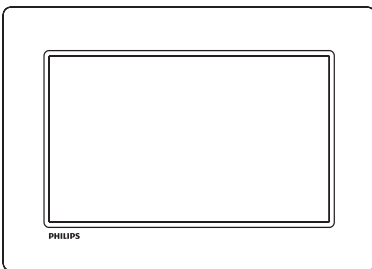

- Philips Digital PhotoFrame

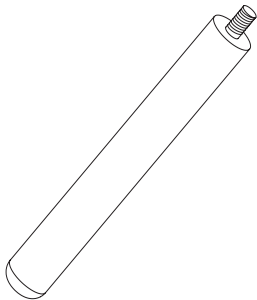

- Stand

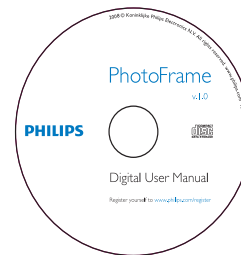

- CD-ROM
  - Digital User Manual
  - Auto Run software

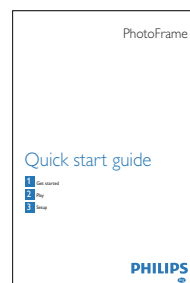

- Quick Start Guide

# Overview of your PhotoFrame

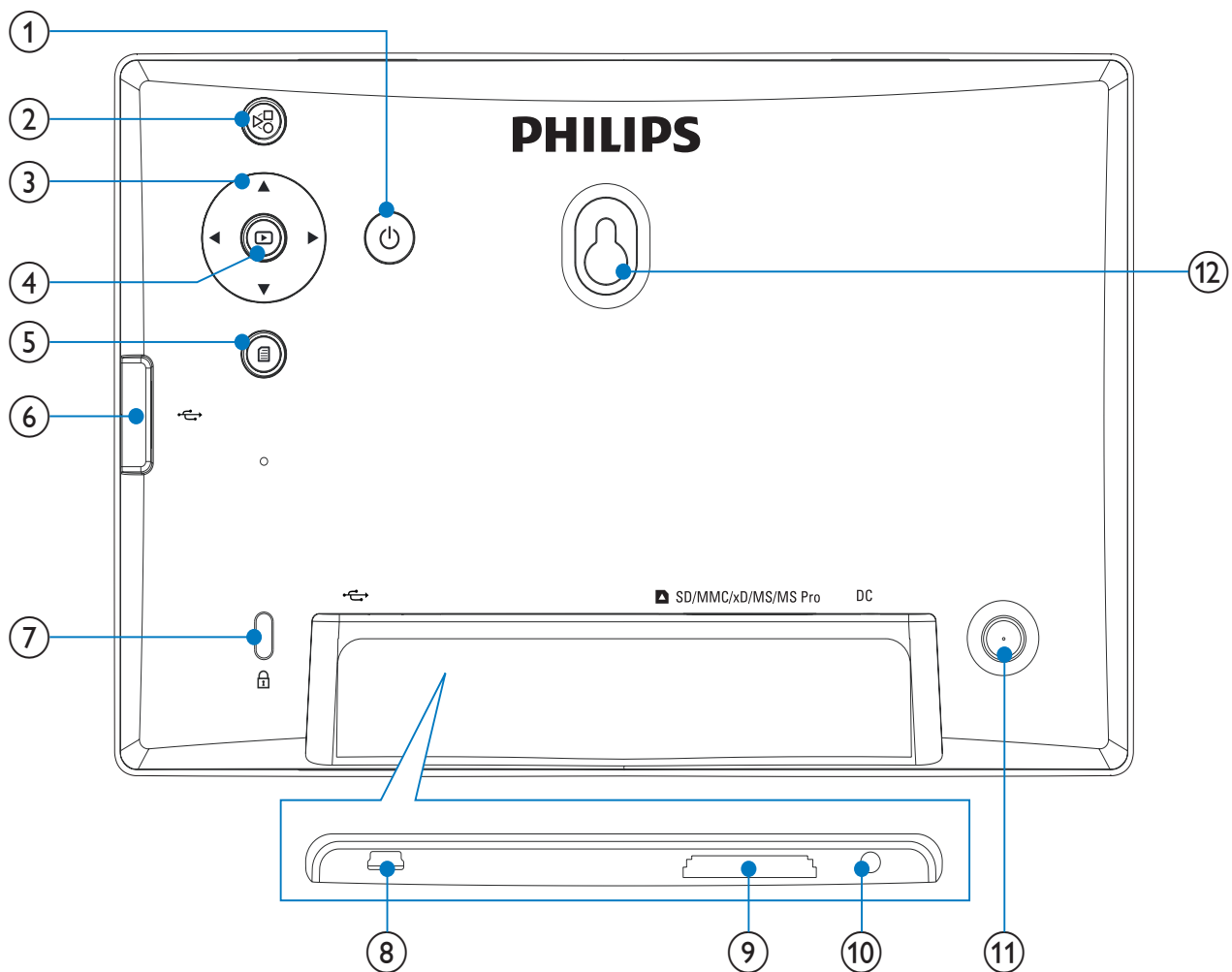

- |   |  |
|---|--|
| <p>①  Turn on/off the PhotoFrame</p> <p>②  Toggle between slideshow mode, thumbnail mode, and main menu</p> <p>③  Select the previous/next/right/left option</p> <p>④  Play photos in slideshow mode, browse mode, or clock mode</p> <ul style="list-style-type: none"> <li>• Pause slideshow</li> <li>• Confirm a selection</li> </ul> <p>⑤  Enter/Exit photo menu</p> | <p>⑥  Slot for a USB flash drive</p> <p>⑦  Kensington lock</p> <p>⑧  Slot for a USB cable to PC</p> <p>⑨  Slot for an SD/MMC/xD/MS/MS Pro card</p> <p>⑩ <b>DC</b></p> <ul style="list-style-type: none"> <li>• Socket for the AC-DC power adaptor</li> </ul> <p>⑪ <b>Stand hole</b></p> <p>⑫ <b>Wall mounting hole</b></p> |
|---|--|

# 3 Get started

## Caution

- Use the controls only as stated in this user manual.

Always follow the instructions in this chapter in sequence.

If you contact Philips, you will be asked for the model and serial number of this apparatus. The model number and serial number are on the back of the apparatus. Write the numbers here:

Model No. \_\_\_\_\_

Serial No. \_\_\_\_\_

## Install the stand

To place the PhotoFrame on a flat surface, attach the supplied stand to the back of the PhotoFrame.

- 1 Insert the stand into the PhotoFrame.

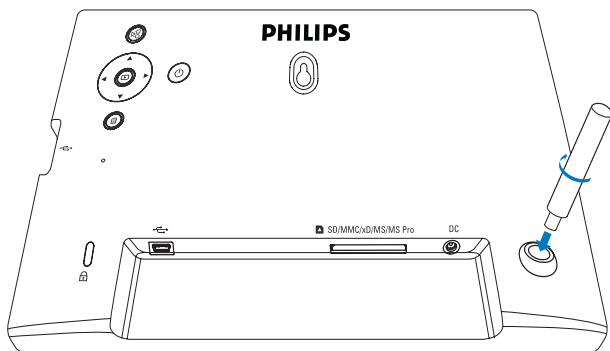

- 2 Screw the stand into the stand hole firmly.

## Connect power

### Note

- When you position the PhotoFrame, ensure that the power plug and outlet are easily accessible.

- 1 Connect the power cord to the DC socket of the PhotoFrame.

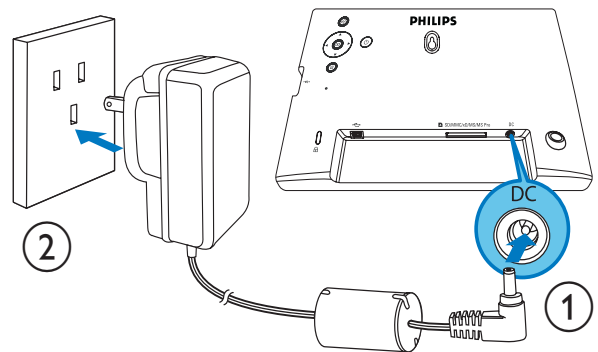



- 2 Connect the power cord to a power supply socket.

## Turn on the PhotoFrame

### Note

- You can only turn off the PhotoFrame after all copy and save actions are complete.

- 1 Press and hold  for more than 1 second.
  - ↳ Photos are displayed in slideshow mode.
  - To turn off the PhotoFrame, press and hold .



## Connect a storage device

### ! Caution

- Do not remove a storage device from the PhotoFrame when files are transferring from or to the storage device.

You can play JPEG photos in one of the following storage device which is connected to the PhotoFrame:

- Secure Digital (SD)
- Secure Digital (SDHC)
- Multimedia Card (MMC)
- xD card (xD)
- Memory Stick (MS)
- Memory Stick Pro (with adaptor)
- USB memory drive

However, we do not guarantee the operations for all types of memory card media.

- 1 For xD/SD/MMC/MS/MS Pro card, insert it into the slot until you hear a "CLICK".
  - For USB memory drive, insert it into the slot firmly.

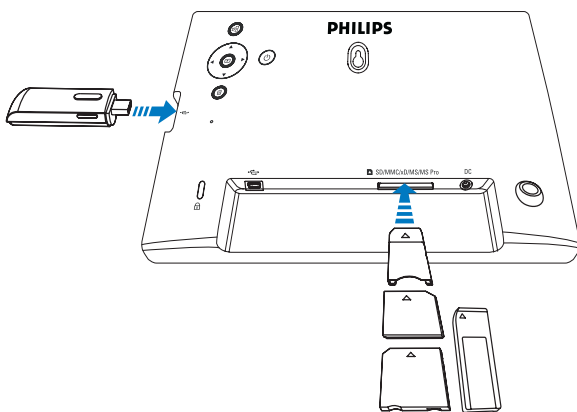

- Photos in the storage device are displayed in slideshow mode.

### To remove a storage device:

- For xD/SD/MMC/MS/MS Pro card, push the card inward and then pull it out.

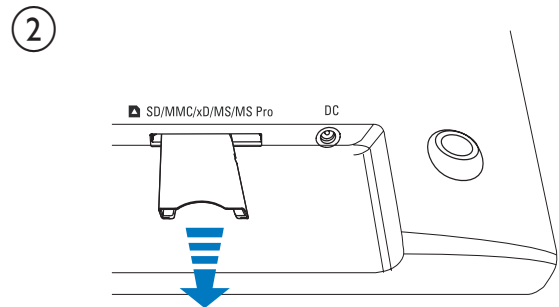
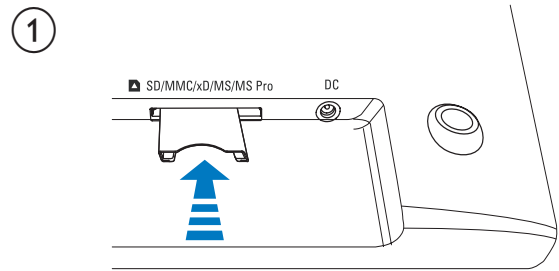

- For USB memory drive, pull it out from the PhotoFrame.

## Connect a PC/Mac

### ! Caution

- Do not disconnect the PhotoFrame from the PC when files are transferring between the PhotoFrame and the PC/Mac.

### System requirements:

PC	Mac
Windows® XP, Vista	Mac OS® X

**On PC:**

- 1** Connect the supplied USB cable to the PhotoFrame and to a PC/Mac.

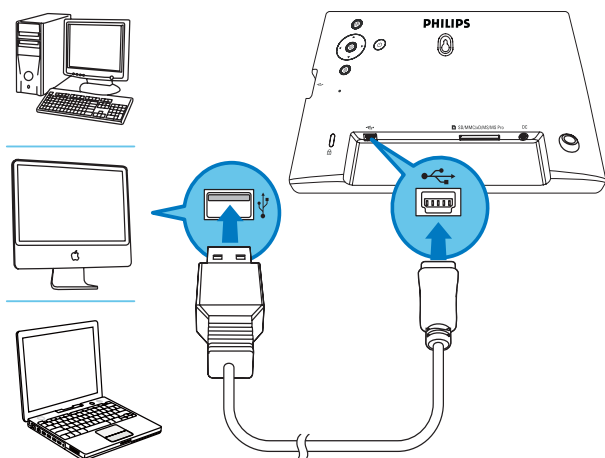

- ↳ You can drag and drop JPEG photos from the PC/Mac to the internal memory of the PhotoFrame.

- 2** After all copy and save actions are complete, disconnect the USB cable from the PC/Mac and the PhotoFrame.

# 4 Photo

## Play photos

- 1 In the main menu, select **[Photo]** and then press  to confirm.

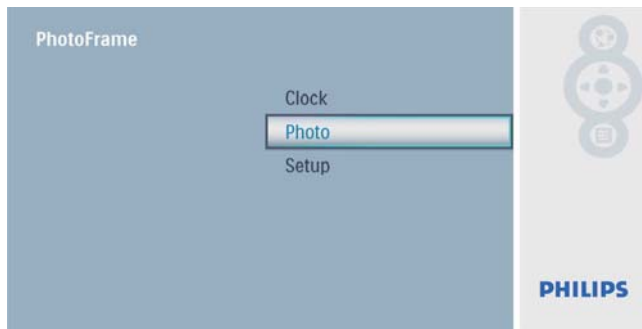

- 2 Select a photo source, and then press  to confirm.

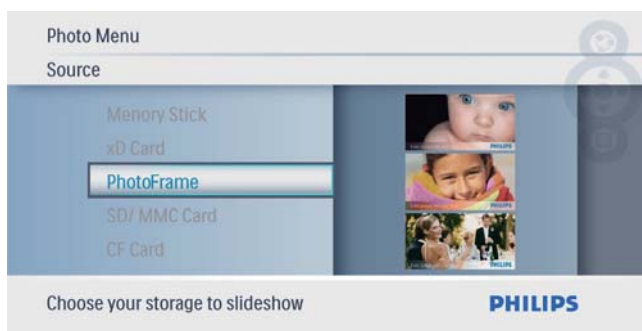

- 3 Select a photo, and then press  to confirm.

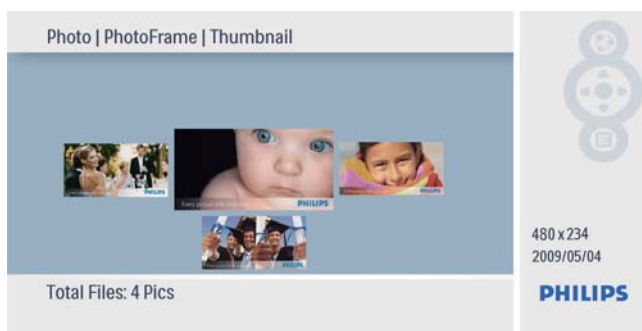

## Manage photos/slideshow

You can manage a photo or set slideshow setting in slideshow/thumbnail mode.

- 1 In slideshow/thumbnail mode, press .  
↳ Photo menu is displayed.



## Copy a photo

### ! Caution

- Never remove a storage device before the copy or delete action completes.

- 1 In **[Photo Menu]**, select **[Copy To]** and then press  to confirm.



- 2 Press  to start copy.  
↳ The photo is copied to the PhotoFrame.

### \* Tip

- When there is not enough memory to store more images, an error message is displayed.

## Delete a photo

### ! Caution

- Never remove a storage device before the copy or delete action completes.

- 1 In **[Photo Menu]**, select **[Delete]** and then press  to confirm.



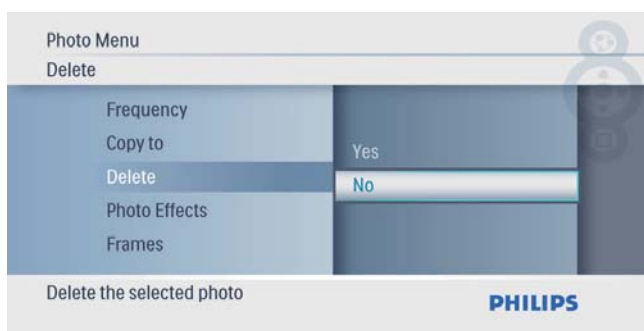

- 2 Select **[Yes]**, and then press  to confirm.

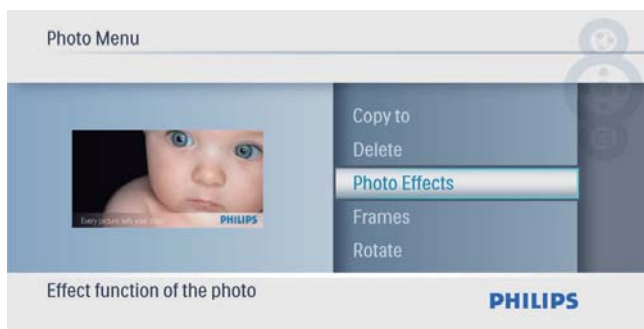

## Select a photo effect

- 1 In **[Photo Menu]**, select **[Photo Effects]** and then press  to confirm.



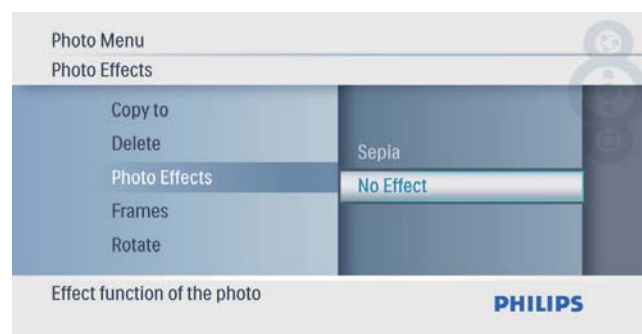

- 2 Select an option, and then press  to confirm.



## Select a photo frame

- 1 In **[Photo Menu]**, select **[Frames]** and then press  to confirm.





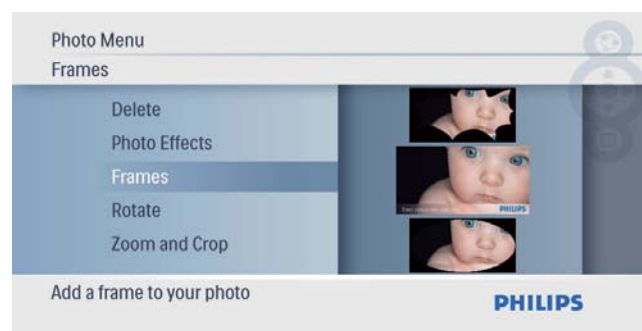

- 2 Press / to select a frame, and then press  to confirm.

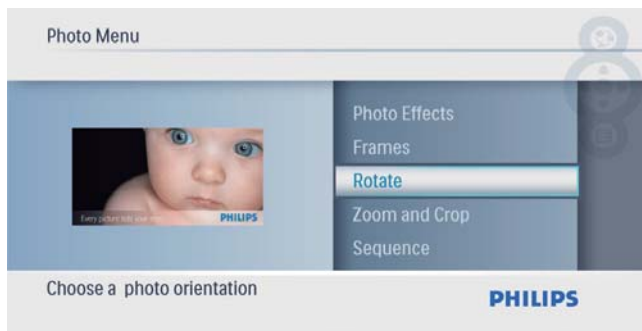

## Rotate a photo

- 1 In **[Photo Menu]**, select **[Rotate]** and then press  to confirm.





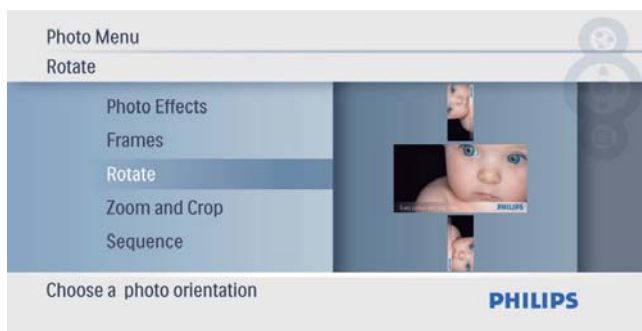



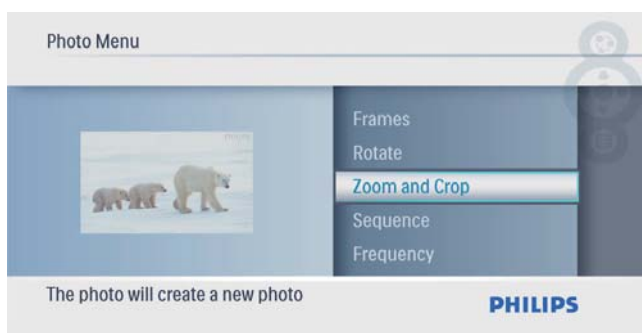

- 2 Press / to select an orientation, and then press  to confirm.



## Zoom and crop a photo

- 1 In **[Photo Menu]**, select **[Zoom and Crop]** and then press  to confirm.



- 2 Press  to zoom in a photo, and then press  to confirm.
  - Press  to zoom out a photo, and then press  to confirm.
- 3 Press / to pan the photo, and then press  to confirm.
- 4 Select **[Yes]**, and then press  to confirm.

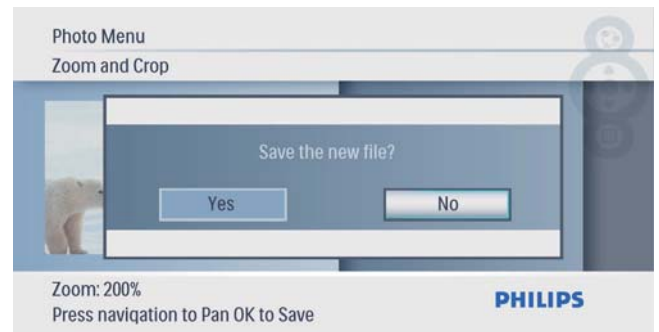

### Tip

- Zoom and crop function is only applied to photos over 480 x 234 pixel.

## Select slideshow sequence

You can display the slideshow in sequence or randomly.

- 1 In **[Photo Menu]**, select **[Sequence]** and then press  to confirm.



- 2 Select an option, and then press  to confirm.

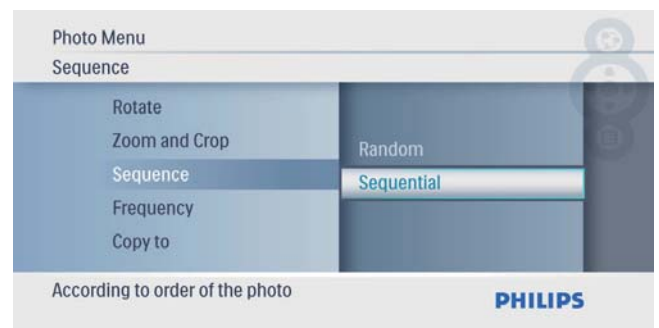

## Select slideshow frequency

- 1 In [Photo Menu], select [Frequency] and then press  to confirm.



- 2 Select a transition time, and then press  to confirm.



# 5 Clock

## Set time and date

- 1 In the main menu, select **[Clock]** and then press  to confirm.

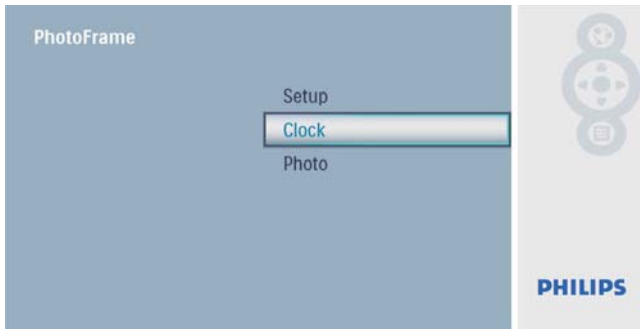





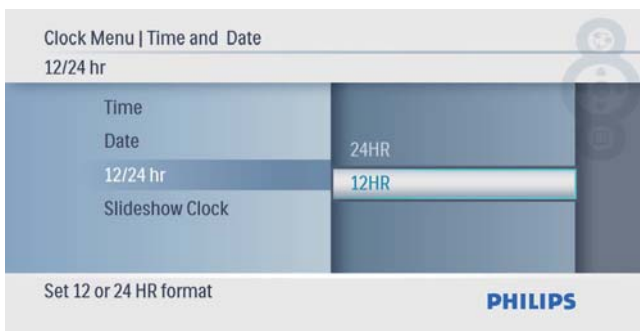

- 2 Select **[Time and Date]**, and then press  to confirm.



- Select **[12/24 hr]** > **[12HR]** / **[24HR]**, and then press  to confirm.



- 3 Select **[Time]** / **[Date]**, and then press  to confirm.
- 4 Press /// to set time/date, and then press  to confirm.

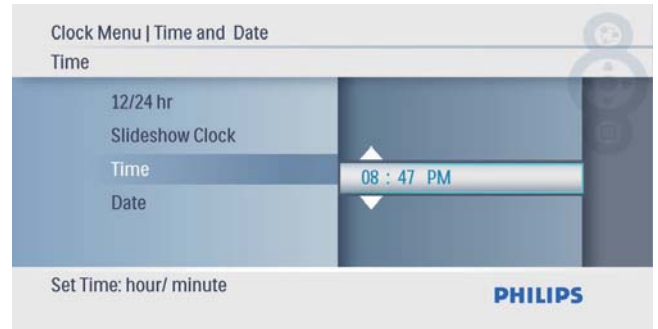

## Show clock in slideshow

- 1 In the **[Time and Date]** menu, select **[Slideshow Clock]** and then press  to confirm.



- 2 Select **[Yes]**, and then press  to confirm.

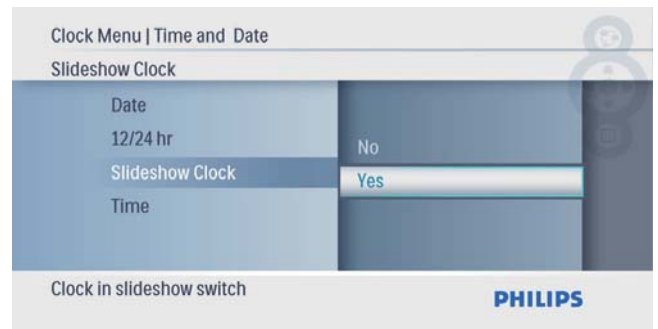

↳ You can have clock shown in slideshow.

## Set alarm clock

### Note

- Ensure that you set time and date of your PhotoFrame correctly.

- 1 In the main menu, select **[Clock]** and then press  to confirm.

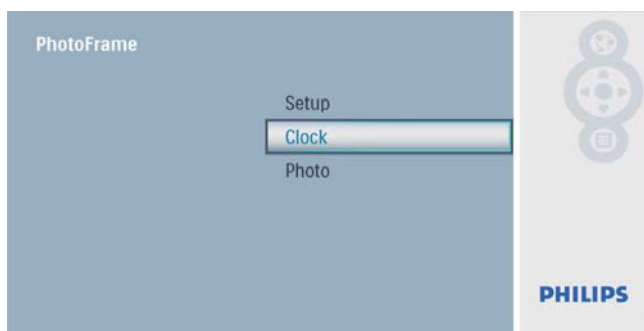

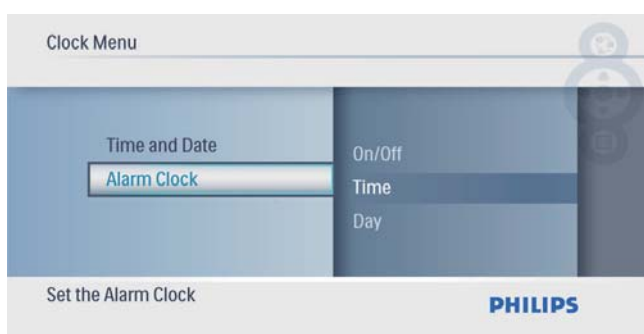

- 2 Select **[Alarm Clock]**, and then press  to confirm.



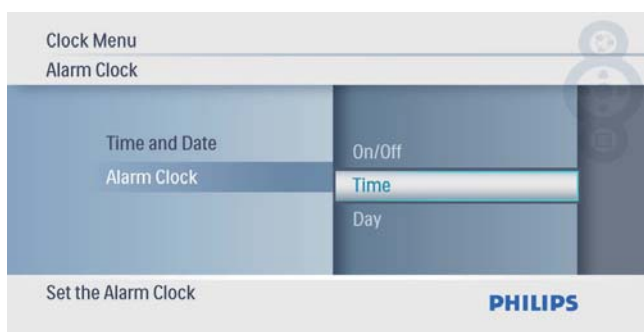

↳ The **[Alarm Clock]** menu is displayed.

- 3 Select **[Time]**, and then press  to confirm.

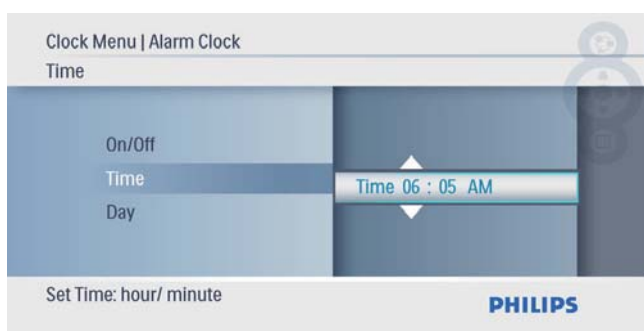

- 4 Press /// to set time for an alarm clock, and then press  to confirm.



- 5 Select **[Day]** for an alarm clock, and then press  to confirm.

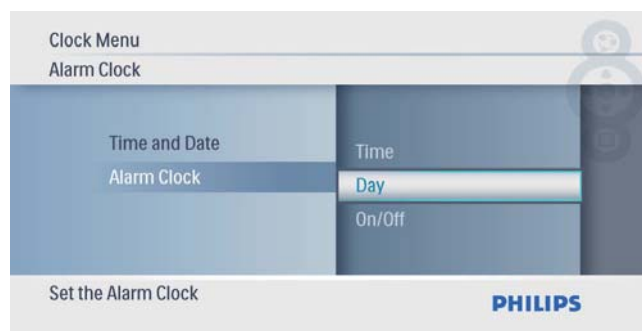

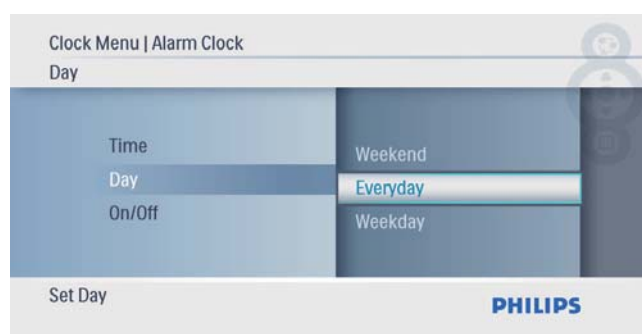

- 6 Selection an option, and then press  to confirm.

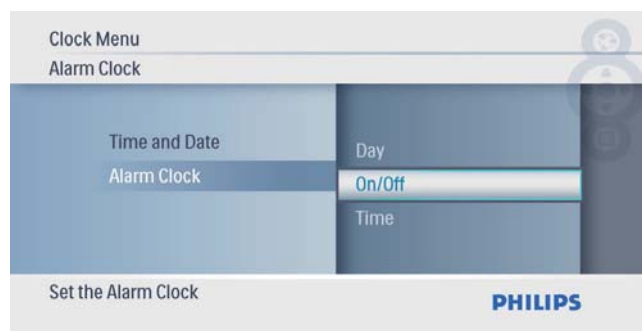

- 7 Select **[On/Off]**, and then press  to confirm.



- 8 Select **[On]**, and then press  to confirm.
- To set off an alarm clock, select **[Off]** and then press  to confirm.





# 6 Setup

## Select an on-screen language

- 1 In the main menu, select **[Setup]** and then press  to confirm.

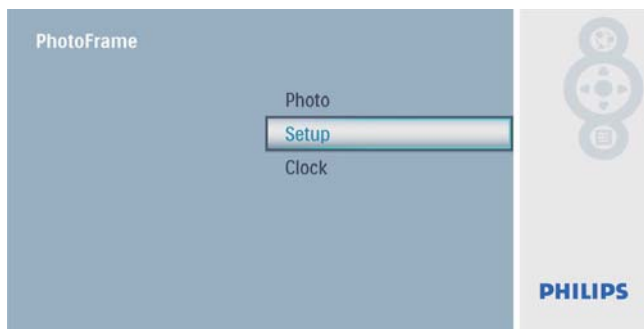

- 2 Select **[Language]**, and then press  to confirm.

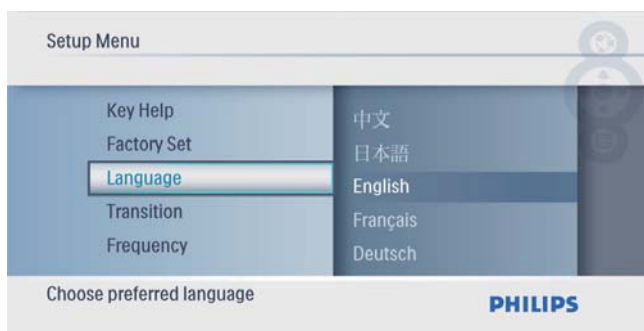

- 3 Select a language, and then press  to confirm.



## Select a slideshow transition effect

- 1 In the main menu, select **[Setup]** and then press  to confirm.

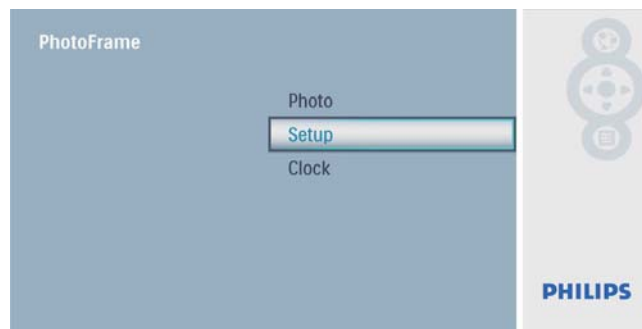

- 2 Select **[Transition]**, and then press  to confirm.



- 3 Select an option, and then press  to confirm.

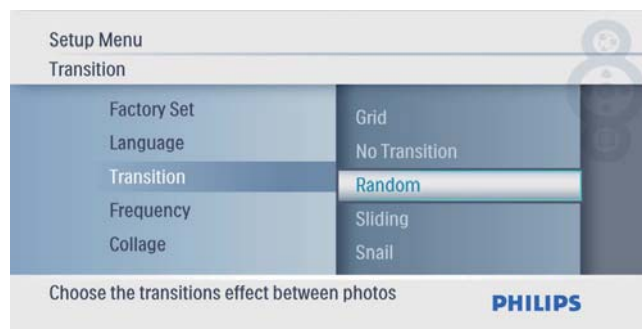

## Select a slideshow frequency

- 1 In the main menu, select **[Setup]** and then press  to confirm.



- 2 Select **[Frequency]**, and then press  to confirm.



- 3 Select an option, and then press  to confirm.



## Display collage photos

- 1 In the main menu, select **[Setup]** and then press  to confirm.

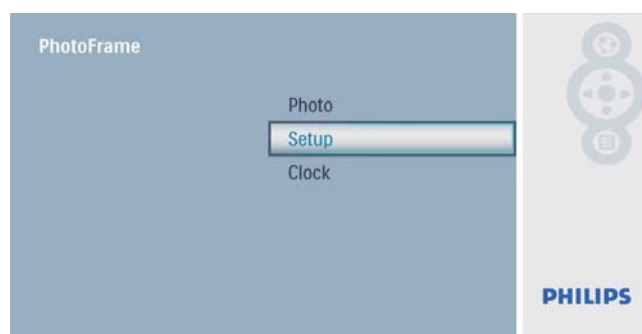

- 2 Select **[Collage]**, and then press  to confirm.



- 3 Select **[Random]**, and then press  to confirm.

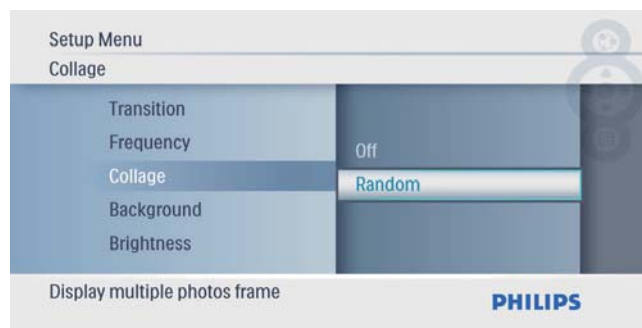

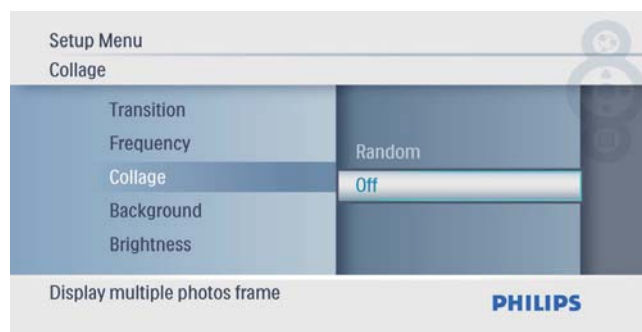

- To disable collage function, select **[Off]** and then press  to confirm.

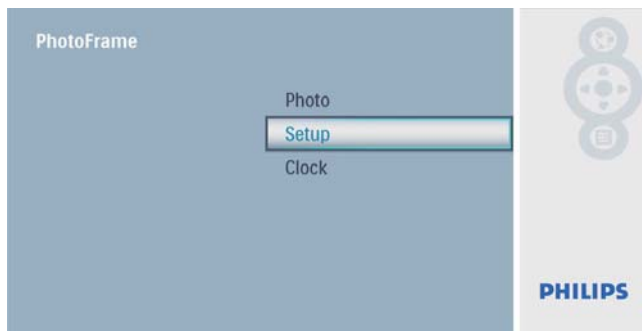

## Select a photo background

- 1 In the main menu, select **[Setup]** and then press  to confirm.



- 2 Select **[Background]**, and then press  to confirm.



- 3 Select an option, and then press  to confirm.
  - ↳ If you select a background color, the PhotoFrame displays a photo with a background color.



- ↳ If you select **[Auto Fit]**, the PhotoFrame extends a photo to fill the screen with picture distortion.



- ↳ If you select **[RadiantColor]**, the PhotoFrame extends the color on the edges of a photo that is smaller than the full screen to fill the screen without black bars or aspect ratio distortion.



## Adjust display brightness

- 1 In the main menu, select **[Setup]** and then press  to confirm.



- 2 Select **[Brightness]**, and then press  to confirm.



- 3 Press ▲/▼ to adjust brightness level, and then press ▶ to confirm.



## Select a slideshow sequence

- 1 In the main menu, select [Setup] and then press ▶ to confirm.

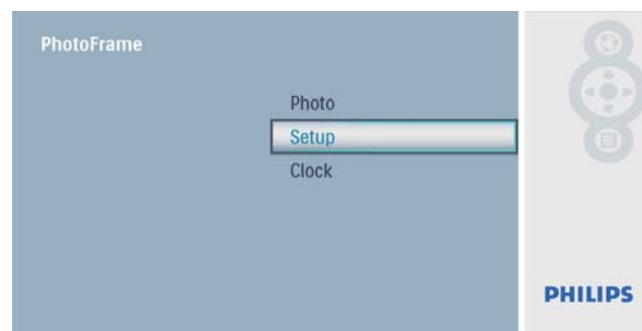

- 2 Select [Sequence], and then press ▶ to confirm.



- 3 Selection an option, and then press ▶ to confirm.

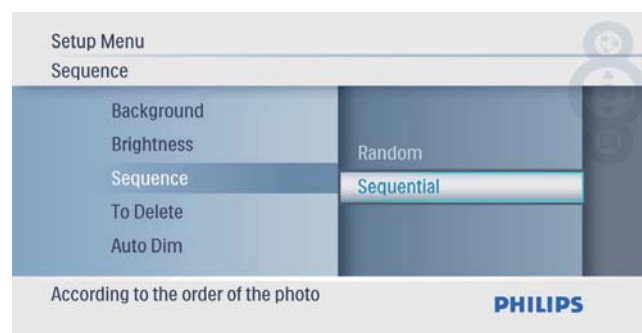

## Protect/Unprotect content of a memory card

You can enable the delete function on a storage device available on the PhotoFrame. To avoid deleting photos on a storage device, you can also disable the delete function on a storage device.

- 1 In the main menu, select **[Setup]** and then press  to confirm.

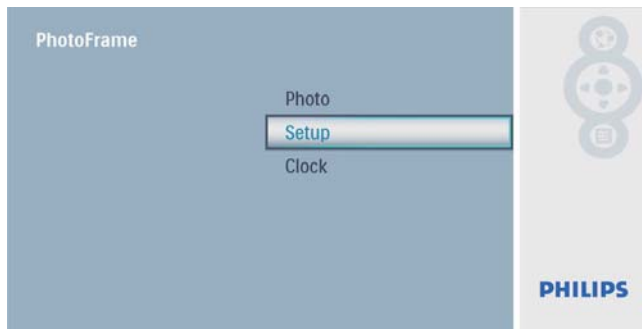

- 2 Select **[To Delete]**, and then press  to confirm.



- 3 Select **[Allow]** / **[Not Allow]**, and then press  to confirm.

## Set display auto on/off

You can configure the time for the PhotoFrame to turn on or off the display automatically.

### Note

- Ensure that you set the current time and date of the PhotoFrame before you set the auto on/off function.

- 1 In the main menu, select **[Setup]** and then press  to confirm.

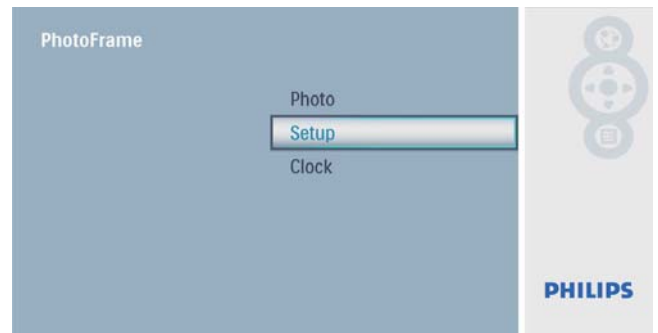





- 2 Select **[Auto Dim]**, and then press  to confirm.

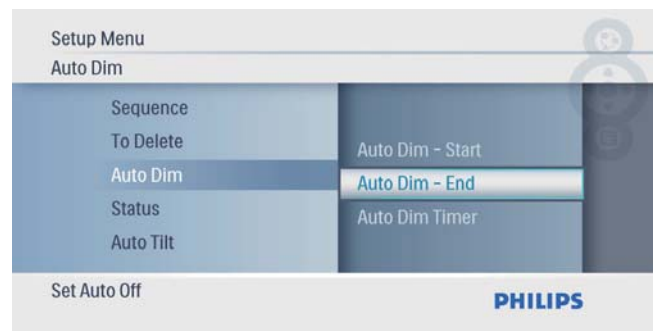

- 3 Select **[Auto Dim - End]** / **[Auto Dim - Start]**, and then press  to confirm.



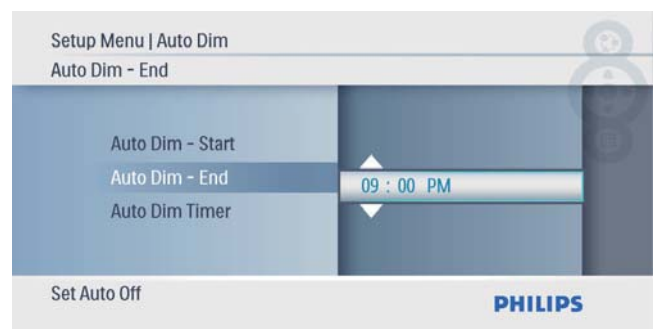

- 4 Press /// to set time for auto-on/ auto-off, and then press  to confirm.

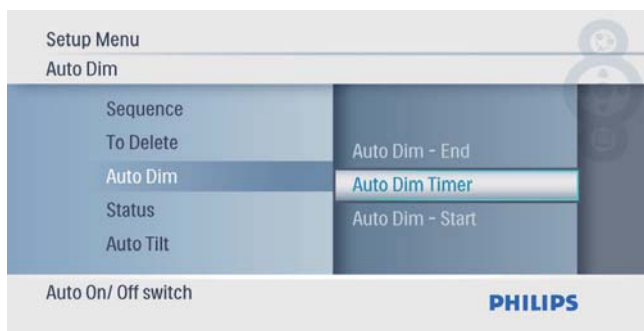

- 5 Select **[Auto Dim Timer]**, and then press  to confirm.



- 6 Select **[On]**, and then press  to confirm.
- To set off auto-on/auto-off function, select **[Off]** and then press  to confirm.

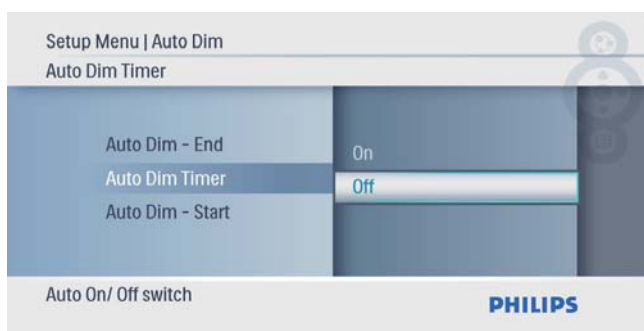

## View the status of the PhotoFrame

- 1 In the main menu, select **[Setup]** and then press  to confirm.



- 2 Select **[Status]**.



- ↳ The status of the PhotoFrame is displayed on the right of the screen.

## Set auto orientation

You can display photos in the correct orientation depending the horizontal/vertical orientation of the PhotoFrame.

- 1 In the main menu, select **[Setup]** and then press  to confirm.

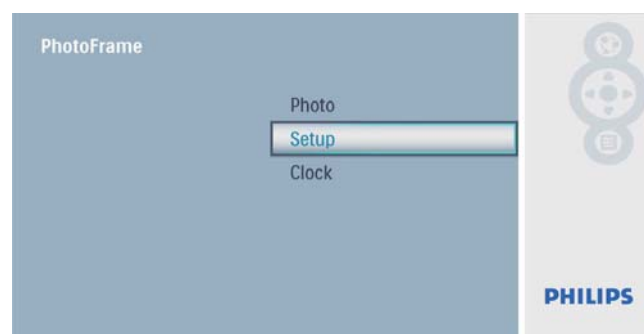

- 2 Select **[Auto Tilt]**, and then press  to confirm.



- 3 Select **[On]**, and then press  to confirm.

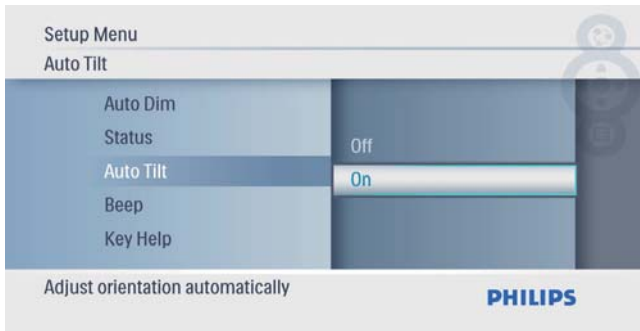

- To set off auto orientation function, select **[Off]** and then press  to confirm.

## Set button sound

- 1 In the main menu, select **[Setup]** and then press  to confirm.

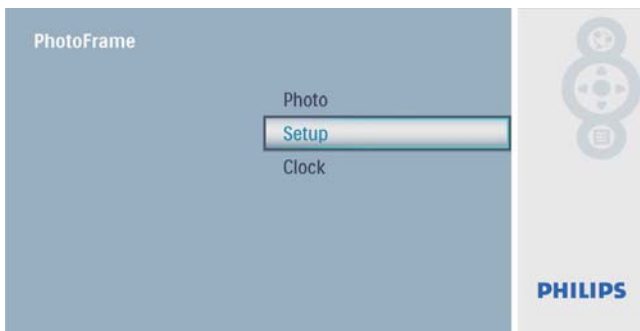

- 2 Select **[Beep]**, and then press  to confirm.

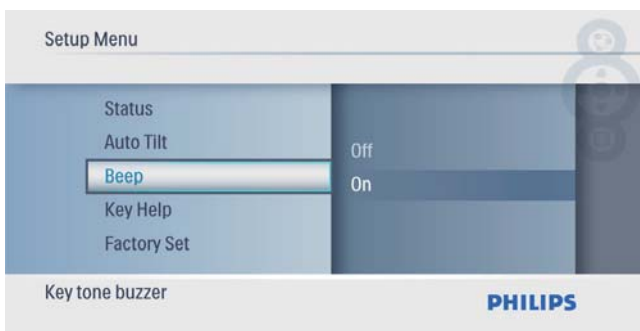

- 3 Select **[On]** to turn on the button sound, and then press  to confirm.

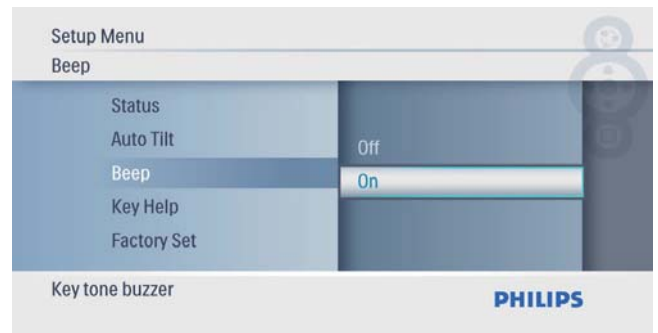

- To turn off the button sound, select **[Off]** and then press  to confirm.

## Display key hints at power on

- 1 In the main menu, select **[Setup]** and then press  to confirm.

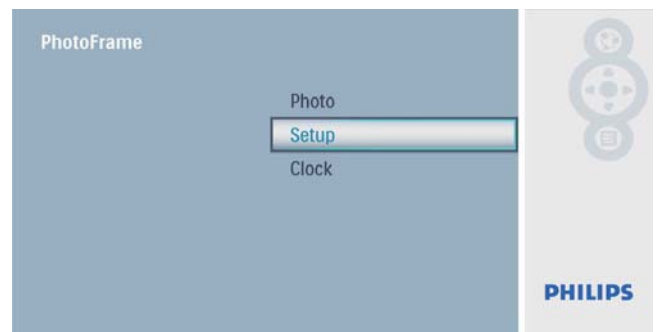

- 2 Select **[Key Help]**, and then press  to confirm.

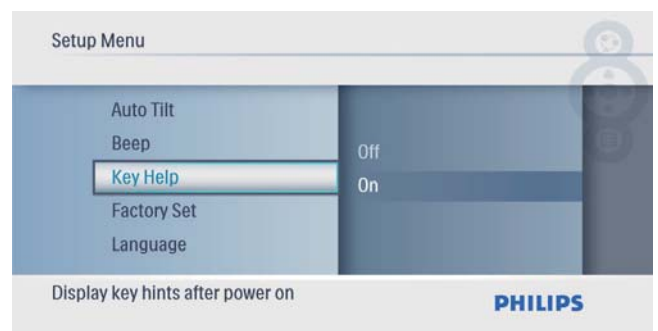

- 3 Select **[On]** to display key hints at power on, and then press  to confirm.

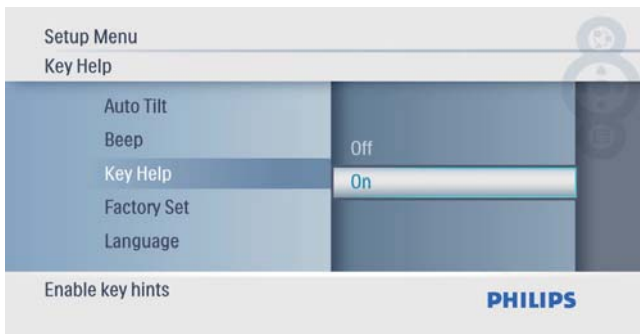

- To not display key hints at power on, select **[Off]** and then press  to confirm.

## Set to factory default

- 1 In the main menu, select **[Setup]** and then press  to confirm.

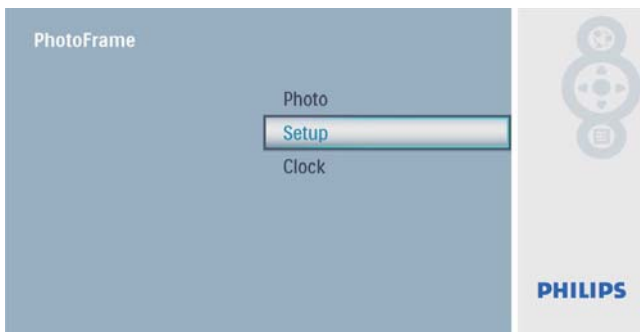

- 2 Select **[Factory Set]**, and then press  to confirm.

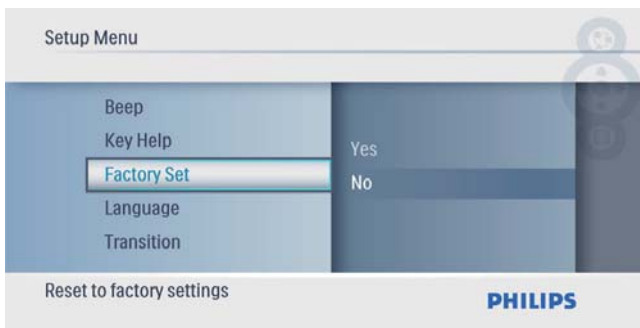

- 3 Select **[Yes]**, and then press  to confirm.





# 7 Product information

## Note

- Product information is subject to change without prior notice.

### Picture/Display

- Viewing angle: @ C/R > 10, 140° (H)/100° (V)
- Lifetime, to 50% brightness: 20000 hr
- Aspect ratio: 16:9
- Panel resolution: 480 × 234
- Brightness (typical): 250 cd/m<sup>2</sup>
- Contrast ratio (typical): 300:1

### Storage media

- Memory card types:
  - Secure Digital (SD)
  - Secure Digital (SDHC)
  - Multimedia Card
  - xD card
  - Memory Stick
  - Memory Stick Pro
  - USB: USB flash drive
- Built-in memory capacity: 512 MB (For up to 500 High Definition photos, around 26MB used by system)

### Connectivity

USB: USB 2.0 Host, USB 2.0 Slave

### Dimensions

- Set dimensions (W × H × D): 206 × 139 × 25.4 mm
- Set dimensions with stand (W × H × D): 206 × 139 × 104.1 mm
- Weight (Main unit): 0.348 kg
- Temperature range (operation): 0°C - 40°C/32°F - 104°F
- Temperature range (storage): -10°C - 60°C/14°F - 140°F

### Power

- Power mode supported: AC powered
- Input: 100 - 240 V ~ 50/60 Hz 0.6 A
- Output: 9 V  $\equiv$  2 A
- Efficiency level: IV

- Consumption: (system on): 4.5 W

### Accessories

- AC-DC power adaptor
- Stand
- Quick Start Guide
- CD-ROM
  - Digital User Manual
  - Auto Run software

### Convenience

- Card Reader: Built-in
- Photo format supported: JPEG photo (Up to 10MB JPEG files, Up to 64 Megapixels)
- Placement supported: Photo auto orientation, Landscape, Portrait
- Buttons and controls: 3 buttons, 4-way navigation key and enter
- Playback mode: Slideshow, Thumbnail browse
- Photo edit: Copy, Delete, Frames, Rotate, Photo Effects, Zoom and Crop
- Photo effects: No effect, Sepia
- Slideshow setting: Slideshow Sequence, Transition Effect, Frequency, Collage, Background Color
- Screen background: Black, White, Gray, Auto fit, Radiant color
- Setup function: Brightness adjustment, Language, Status, Beep on/off, Set time and date, Clock display enable/disable, Auto on/off
- System status: Firmware version, Remaining memory
- Plug & Play Compatibility: Windows Vista, Windows 2000/XP or later
- Regulatory Approvals: BSMI, C-Tick, CCC, CE, GOST, PSB, Switzerland
- Other convenience: Kensington lock compatible
- On-Screen Display languages: English, Spanish, German, French, Italian, Dutch, Danish, Russian, Simplified Chinese, Japanese

## 8 Frequently asked questions

### **Is the LCD screen touch-enabled?**

The LCD screen is not touch-enabled. Use the buttons on the back to control the PhotoFrame.

### **Can I switch different slideshow photos by using different memory cards?**

Yes. When a memory card is connected to the PhotoFrame, you can play photos on the specific memory card in slideshow mode.

### **Will the LCD be damaged, if I keep showing the same photo for a long time?**

No. The PhotoFrame can display the same photo continuously for 72 hours without any damage to the LCD screen.

### **Why does my PhotoFrame not show some of my photos?**

The PhotoFrame supports only JPEG photos. Ensure that these JPEG photos are not damaged.

### **Can I use the PhotoFrame during its display auto-off periods?**

Yes. You can press  $\phi$  to wake up the PhotoFrame.

### **Why does the PhotoFrame not go into auto-off status after I set it?**

Ensure that you set the current time, auto-off time, and auto-on time correctly. The PhotoFrame automatically turns off its display exactly at the auto-off time. If the time has already passed for the day, it starts to enter auto-off status at the specified time from the next day.

### **Can I increase the memory size to store more pictures on the PhotoFrame?**

No. The internal memory of the PhotoFrame is fixed and cannot be expanded. However, you could switch between different photos by using different storage devices on the PhotoFrame.

# 9 Glossary

---

## A

### Aspect ratio

Aspect ratio refers to the length to height ratio of TV screens. The ratio of a standard TV is 4:3, while the ratio of a high-definition or wide TV is 16:9. The letter box allows you to enjoy a picture with a wider perspective on a standard 4:3 screen.

---

## J

### JPEG

A very common digital still picture format. A still-picture data compression system proposed by the Joint Photographic Expert Group, which features small decrease in image quality in spite of its high compression ratio. Files are recognized by their file extension '.jpg' or '.jpeg'.

---

## K

### Kensington lock

A Kensington Security Slot (also called a K-Slot or Kensington lock). Part of an anti-theft system. It is a small, metal-reinforced hole found on almost all small or portable computer and electronics equipment, particularly on expensive and/or relatively light ones, such as laptops, computer monitors, desktop computers, gaming consoles, and video projectors. It is used for attaching a lock-and-cable apparatus, in particular those from Kensington.

---

## M

### Memory Stick

Memory Stick. A flash memory card for digital storage on cameras, camcorders and other handheld devices.

### MMC Card

MultiMedia Card. A flash memory card that provides storage for cellphones, PDAs and other handheld devices. The card uses flash memory for read/write applications or ROM chips (ROM-MMC) for static information, the latter widely used for adding applications to a Palm PDA.

---

## S

### SD Card

Secure Digital Memory Card. A flash memory card that provides storage for digital cameras, cellphones and PDAs. SD Cards use the same 32 x 24mm form factor as the MultiMediaCard (MMC), but are slightly thicker (2.1mm vs. 1.4mm), and SD Card readers accept both formats. Cards up to 4GB are available.

---

## X

### xD Card

EXtreme Digital Picture Card. A flash memory card used in digital cameras.

