

Micro Hi-Fi System

MCM275

User manual

用戶手冊



PHILIPS

CAUTION

Visible and invisible laser radiation. If the cover is open, do not look at the beam.

High voltage! Do not open. You run the risk of getting an electric shock.

The machine does not contain any user-serviceable parts.

Modification of the product could result in hazardous radiation of EMC or other unsafe operation.

If you disconnect the product from the mains, make sure to take the plug out of the wall socket completely.

Children could seriously injure themselves as the free end of the cable may still be live if only the connector is removed from the MAINS socket at the back of the unit.

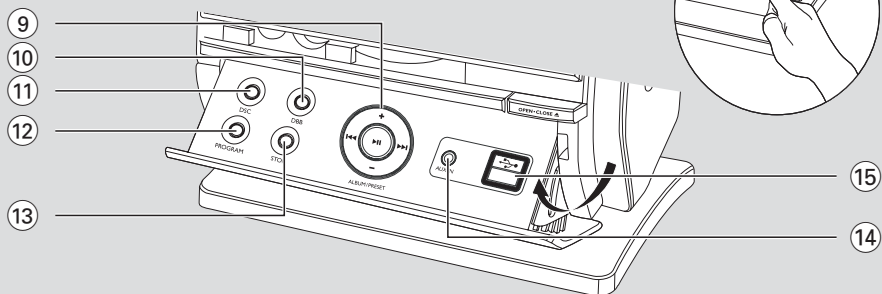
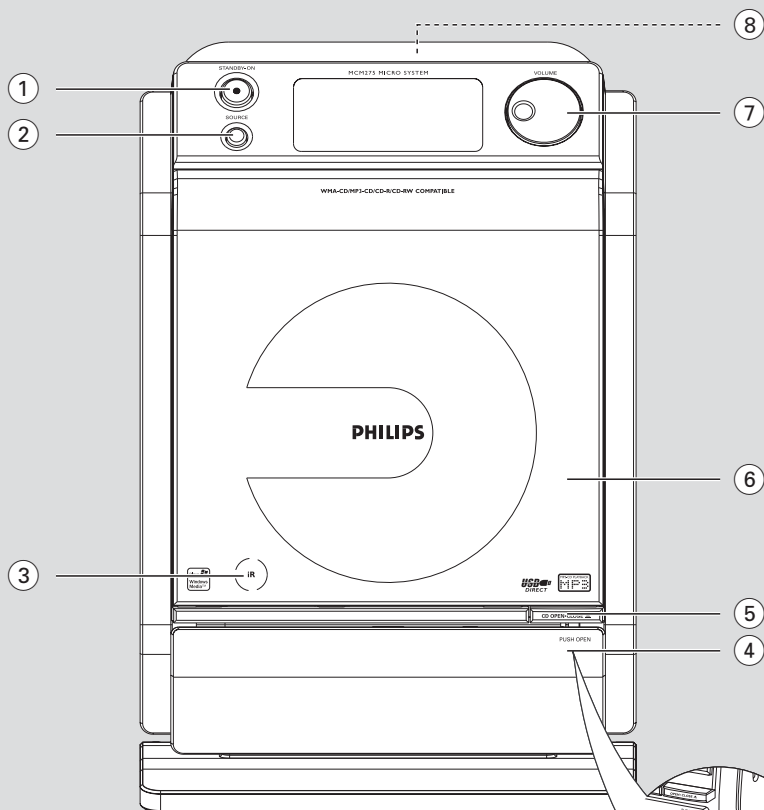

English 6

中文 30

General Information

Supplied accessories	7
Environmental information	7
Safety information	7

Controls

Controls on the set	8
Remote control	9-10

Installation

Placing MCM275	10
Mounting stand onto the set	
Mounting MCM275 onto walls	
Rear connections	11-12
Speaker connections	
Antenna connections	
Connecting an additional appliance	12-13
Connecting a USB device	
Connecting a non-USB device	
Using AC power	13

Preparations

Using the remote control	14
Setting the clock	14

Basic Functions

Switching on/off the set and selecting functions	15
Auto-standby	15
Volume control	16
Volume adjustment	
MUTE	
Sound control	16
DSC	
DBB	
Displaying the clock	16

CD

Discs for playback	17
Playing discs	17-18
Selecting and searching	18
Selecting a different track	
Finding a passage within a track during playback	
Programming tracks	19
Reviewing the program	
Erasing the program	
Different play modes: REPEAT, SHUFFLE	20
Display track information (MP3/WMA only)	20

Tuner

Tuning to radio stations	21
Programming radio stations	21
Autostore:Automatic programming	
Manual programming	
To listen to a preset station	
Changing tuning grid	22

USB

Using a USB mass storage device	23-24
Playing a USB mass storage device	

AUX

AUX (Listening to an external source)	24
---	----

Timer

Setting the timer	25
Activating and deactivating TIMER	25

SLEEP

.....	25
-------	----

Specifications

.....	26
-------	----

Maintenance

.....	26
-------	----

Troubleshooting

.....	27-28
-------	-------

How to mount your MCM275 onto walls

.....	29
-------	----

Supplied accessories

- 2 speaker boxes including 2 speaker cables
- remote control (with 1 x CR2025 battery)
- MW loop antenna
- FM wire antenna
- stand
- mounting kit

Environmental Information

All unnecessary packaging has been omitted. We have tried to make the packaging easy to separate into three materials: cardboard (box), polystyrene foam (buffer) and polyethylene (bags, protective foam sheet).

Your system consists of materials which can be recycled and reused if disassembled by a specialized company. Please observe the local regulations regarding the disposal of packaging materials, exhausted batteries and old equipment.

Safety Information

- Place the system on a flat, hard and stable surface.
- Place the system in a location with adequate ventilation to prevent internal heat build-up in your system. Allow at least 10 cm (4 inches) clearance from the rear and the top of the unit and 5 cm (2 inches) from each side.
- The ventilation should not be impeded by covering the ventilation openings with items, such as newspapers, table-cloths, curtains, etc.
- Do not expose the system, batteries or discs to excessive moisture, rain, sand or heat sources caused by heating equipment or direct sunlight.
- No naked flame sources, such as lighted candles, should be placed on the apparatus.
- No objects filled with liquids, such as vases, shall be placed on the apparatus.
- If the system is brought directly from a cold to a warm location, or is placed in a very damp room, moisture may condense on the lens of the disc unit inside the system. Should this occur, the CD player would not operate normally. Leave the power on for about one hour with no disc in the system until normal playback is possible.
- The mechanical parts of the set contain self-lubricating bearings and must not be oiled or lubricated.
- **When the system is switched to Standby mode, it is still consuming some power. To disconnect the system from the power supply completely, remove the AC power plug from the wall socket.**

Controls on the set (illustrations on page 3)

① STANDBY-ON

- press briefly to switch the set on or to standby mode

② SOURCE

- selects sound source **CD, USB, TUNER** or **AUX**
- **In standby mode:** switches the set on and selects sound source **CD, USB, TUNER** or **AUX**

③ IR

- sensor for the infrared remote control
- **Helpful hints:** Always point the remote control towards this sensor.

④ PUSH OPEN

- push to unfold or fold the control panel

⑤ CD OPEN • CLOSE ▲

- opens/closes the CD door

⑥ CD door

⑦ VOLUME

- adjusts the volume level
- **Clock/Timer:** adjusts the hours and minutes

⑧

- 3.5 mm headphone socket

Helpful hints:

- Adjust the volume to a moderate level before you plug in the headphones.
- Connecting headphones will switch off the speakers.

⑨ ALBUM/ PRESET + /-

- **CD/USB:** selects albums (for MP3/WMA only)
- **TUNER:** selects a preset radio station



- **CD/USB:** skips or searches CD tracks/titles backwards/forwards

- **Tuner:** tunes to radio stations



- **CD/USB:** starts or pauses playback

⑩ DBB (Dynamic Bass Boost)

- turns the bass enhancement on/off

⑪ DSC (Digital Sound Control)

- selects predefined sound settings: **ROCK, JAZZ, POP, CLASSIC**

⑫ PROGRAM

- **CD/USB:** programs tracks
- **Tuner:** programs preset radio stations

⑬ STOP

- **CD/USB:** stops playback; erase a program

⑭ AUX-IN

- connects to the AUDIO OUT jack on the external appliance

⑮

- jack for the external USB mass storage device

Remote control

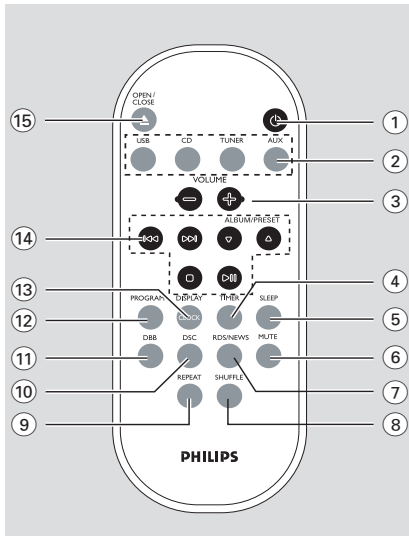

Notes for remote control:

- First select the source you wish to control by pressing one of the source select keys on the remote control (for example CD, TUNER).
- Then select the desired function (for example ► II, ◀◀, ▶▶).

①

- press briefly to switch the set on or to standby mode

② **Source buttons**

USB

- selects **USB** source
- **In standby mode::** switches the set on and selects **USB** source.

CD

- selects **CD** source
- **In standby mode::** switches the set on and selects **CD** source.

TUNER

- selects **TUNER** source and toggles between the wavebands: FM and MW
- **In standby mode::** switches the set on and selects **TUNER** source

AUX

- selects the audio input from an additional connected appliance
- **In standby mode::** switches the set on and selects the audio input from an additional connected appliance
- ③ **VOLUME + / -**
 - adjusts the volume level
- **Clock/Timer:** adjusts the hours and minutes
- ④ **TIMER**
 - displays the timer setting
 - switches the timer on/off
 - enters the timer setting mode (press and hold for more than 2 seconds)

⑤ **SLEEP**

- set the sleep timer

⑥ **MUTE**

- switches the sound off temporarily

⑦ **RDS/NEWS**

- no function on this set

⑧ **SHUFFLE**

- selects random playback

⑨ **REPEAT**

- selects continuous playback

⑩ **DSC (Digital Sound Control)**

- selects predefined sound settings: ROCK, JAZZ, POP, CLASSIC

⑪ **DBB (Dynamic Bass Boost)**

- turns the bass enhancement on/off

⑫ **PROGRAM**

- **CD/USB:** programs tracks
- **Tuner:** programs preset radio stations

⑬ **DISPLAY/CLOCK**

- **Clock:** - displays the set time
 - **In standby mode:** enters the clock setting mode (press and hold for more than 2 seconds)
- **TUNER/Audio CD:** switches between clock display and playback display
- **MP3/WMA:** displays disc information during playback

- ⑭ **◀◀ / ▶▶**
 - **CD/USB:** skips or searches CD tracks backwards/forwards
 - **Tuner:** tunes to radio stations
- ALBUM/ PRESET ▲ / ▼**
 - **CD/USB:** selects the next/previous album (for MP3/WMA only)
 - **TUNER:** selects a preset radio station
- ▶ ||**
 - **CD/USB:** starts or pauses playback
- - **CD/USB:** stops playback; erase a program
- ⑮ **OPEN • CLOSE ▲**
 - opens/closes the CD door

Placing MCM275

With the detachable stand and by-packed wall mounting kit , MCM275 allows you to place it in two ways: **on desktops with stand** or **on walls without stand**.

Mounting stand onto the set

MCM275 is equipped with a stand. To mount the stand onto the set,

- ① Put MCM275 on a flat and firm surface, rear side facing up
- ② As shown, align the stand to the slots at set's bottom, **▼ FRONT** facing down

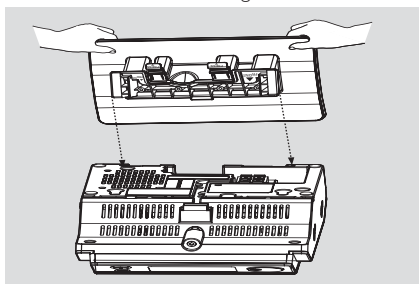

- ③ Push the stand down into the slots
→ When the stand is in place, you will hear a click

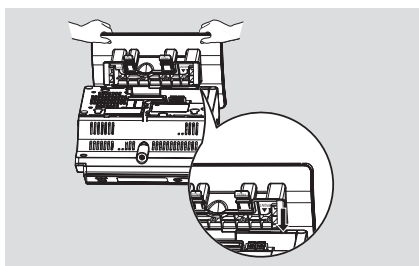

Mounting MCM275 onto walls

See **Appendix: How to mount your MCM275 onto walls** to learn more about wall mounting.

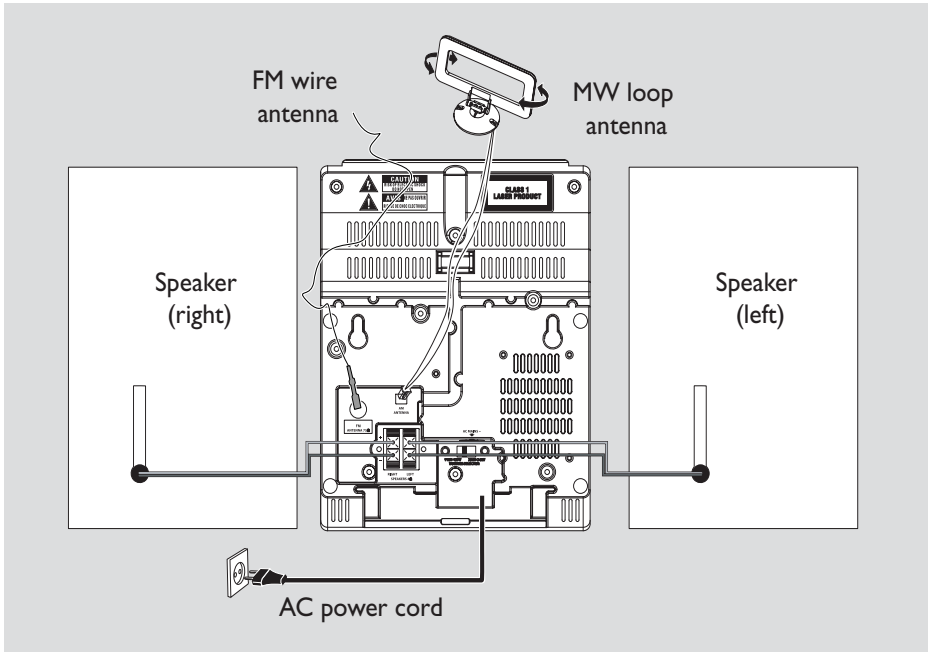

Rear connections

Warning:

- Never make or change connections with the mains supply switched on.
- Install your set near the AC outlet and where the AC power plug can be reached easily.

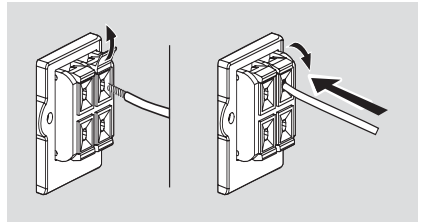

(A) Speaker connections

Use the supplied speakers only. Using other speakers can damage the set or the sound quality will be negatively affected.

- Connect the cable of the left speaker to **LEFT** (red and black) and the cable of the right speaker to **RIGHT** (red and black) as follows:
 - a. Press the clip of the red terminal and fully insert the stripped portion of the colored (or marked) speaker cable into the socket, then release the clip
 - b. Press the clip of the black terminal and fully insert the stripped portion of the black (or unmarked) speaker cable into the socket, then release the clip

(B) Antenna connections MW antenna

- 1 Assemble the loop antenna as shown:

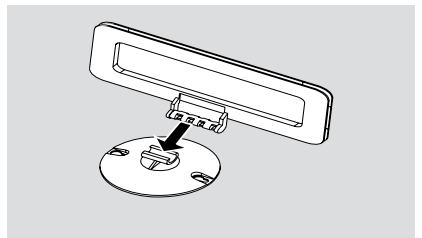

Or

Insert the loop antenna into the slot on the set

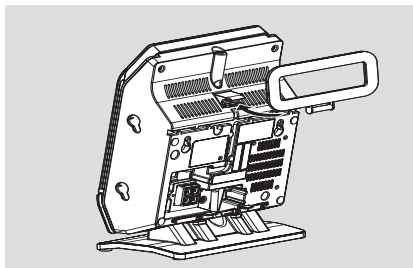

- 2 Fit the plug of the loop antenna to AM (MW) ANTENNA as shown below
- 3 Adjust the position of the antenna for optimal reception (as far away as possible from the TV, VCR or other radiation sources)

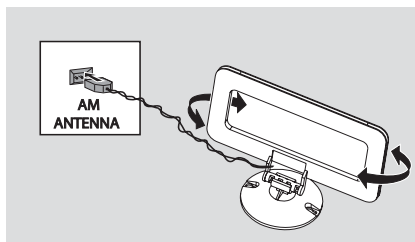

FM antenna

The wire antenna supplied can only be used to receive nearby stations. For better reception we recommend using a cable antenna system or an outdoor antenna.

- 1 Extend the wire antenna and fit it to FM ANTENNA as shown below

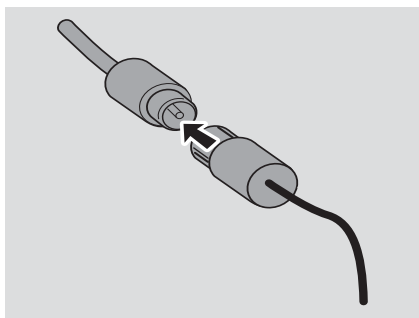

Note: If you are using a cable antenna system or an outdoor antenna, fit the antenna plug, instead of the wire antenna, to FM ANTENNA.

- 2 Move the antenna in different positions for optimal reception (as far away as possible from the TV, VCR or other radiation sources)
- 3 Fix the antenna's end to the wall

Connecting an additional appliance

Connecting a USB device or memory card

By connecting a USB mass storage device (including USB flash memory, USB flash players or memory cards) to the Hi-Fi system, you can enjoy the device's stored music through the powerful speakers of Hi-Fi system.

- 1 Check you have unfolded the control panel

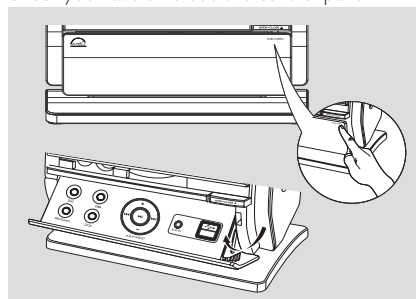

- 2 Insert the USB device's USB plug into the socket  on the set's foldable control panel

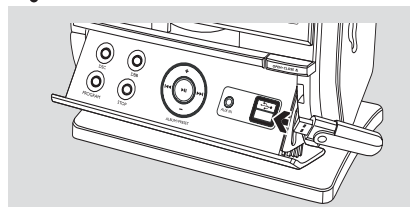

or

for the devices with USB cable:

- a. Insert one plug of the USB cable (not supplied) to the socket  on the set's foldable control panel
- b. Insert the other plug of the USB cable to the USB output terminal of the USB device

or

for the memory card:

- a. Insert the memory card into a card reader (not supplied)
- b. Use a USB cable (not supplied) to connect the card reader to the socket  on the set's foldable control panel

Connecting a non-USB device

It is possible to use an additional appliance, e.g. TV, VCR or CD recorder with the set. On MCM275, you can playback music from an external source.

- 1 Follow the Step 1 under **Connecting a USB device or memory card**
- 2 Insert one plug of the audio cable (not supplied) to the socket **AUX IN** on the set's foldable control panel
- 3 Connect the other end of the audio cable to the **AUDIO OUT** terminal of the additional appliance

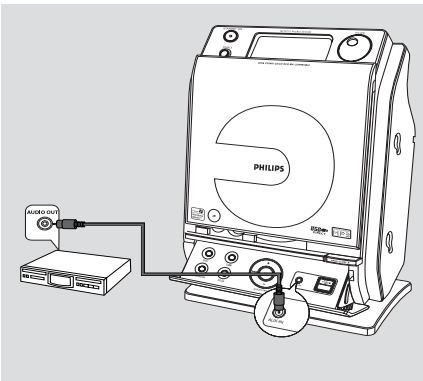

- 4 Select **AUX** mode on the set

Helpful hints:

- Always refer to the owner's manual of other equipment for complete connection.

Using AC power

- 1 Make sure all the connections have been made before switching on the power supply
- 2 If your system is equipped with a Voltage Selector, set the VOLTAGE SELECTOR to the local power line voltage

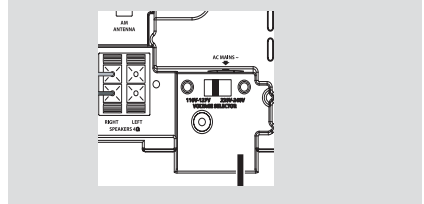

- 3 Connect the AC power cord to the wall socket. This switches on the power supply

When MCM275 is switched to standby, it is still consuming some power. **To disconnect the system from the power supply completely, remove the power plug from the wall socket.**

The type plate is located on the rear of the set.

Warning!

To avoid overheating of the system, a safety circuit has been built in. Therefore, your system may switch to Standby mode automatically under extreme conditions. If this happens, let the system cool down before reusing it (not available for all versions).

Preparation

Using the remote control

IMPORTANT!

- Remove the protective plastic tab before using the remote control.
- Always point the remote control directly towards IR area.

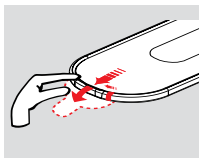

Notes for remote control:

- First select the source you wish to control by pressing one of the source select keys on the remote control (for example CD, TUNER).
- Then select the desired function (for example **II**, **II<<**, **>>II**).

To replace the remote controls' battery

- 1 Press and hold **◀** as indicated
- 2 Simultaneously, pull the battery tray at **▼**
- 3 Remove the old battery and put a new CR2025 battery in place
- 4 Put back the battery tray

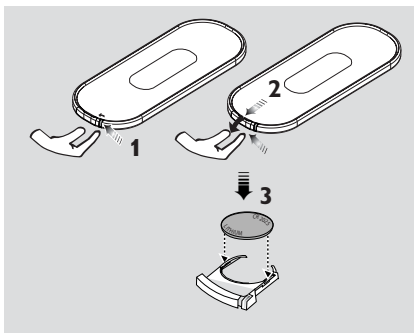

CAUTION!

- Remove the battery if it is exhausted or will not be used for a long time.
- Batteries contain chemical substances, so they should be disposed of properly.

Setting the clock

After connecting MCM275 to the power supply, set the clock first.

- 1 In the standby mode, press and hold **DISPLAY/CLOCK** on the remote control
→ **SET CLOCK** scrolls on the display
→ **24 HR** or **12 HR** appears for the initial clock setting. **To select 24-hour clock or 12-hour clock,**
 - On the remote control, press **VOLUME +/-** once or more (or turn **VOLUME** on the set)
 - On the remote control, press **DISPLAY/CLOCK** to confirm
- 2 The hours digits start flashing
→ Hold down or press **VOLUME +/-** repeatedly to set the hours (or turn **VOLUME** on the set)
- 3 Press **DISPLAY/CLOCK** to confirm
→ The minutes digits start flashing
- 4 Hold down or press **VOLUME +/-** repeatedly to set the minutes (or turn **VOLUME** on the set)
- 5 Press **DISPLAY/CLOCK** to confirm
– To exit without storing the clock setting press **STOP** ■

Helpful hints:

- The clock setting will be erased when the system is disconnected from the power supply.
- The set will exit from the clock setting mode if no button is pressed within 90 seconds.

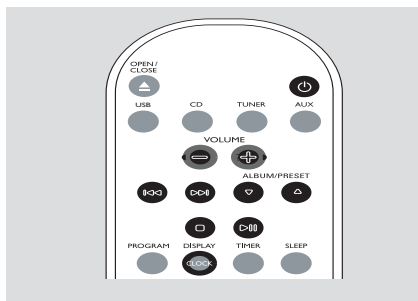

Switching on/off the set and selecting functions

- 1 To switch on, press **STANDBY-ON** or **SOURCE** on the set (or ϕ on the remote control)
 → The set switches to the last source selected
OR
 On the remote control, press the source button (e.g. **USB, CD, TUNER, AUX**)
- 2 When the set is on, press **STANDBY-ON** to switch it to standby mode (or ϕ on the remote control)
- 3 To select your function, press **SOURCE** once or more on the set (or **USB, CD, TUNER, AUX** on the remote control)

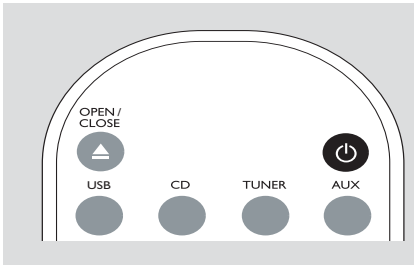

Helpful hints:

- You can also switch on the set by pressing **CD OPEN • CLOSE ▲**

Auto-standby

When the set has reached the end of CD playback and remains in the stop position for more than 15 minutes, the set will switch off automatically to save power.

Basic Functions

Volume control

Volume adjustment

- Adjust the volume by using the **VOLUME** rotary on the set or by pressing **VOLUME +/-** on the remote control
 - **VOL** and the actual value (between 1 and 31) are displayed
 - **VOL MIN** is the minimum volume level
 - **VOL MAX** is the maximum volume level

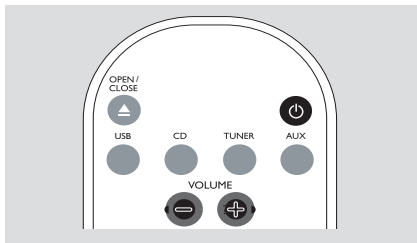

MUTE

You can temporarily switch off the sound without switching off the set.

- 1 Press **MUTE** on the remote control to switch off the sound
 - **MUTE** appears. Playback continues without sound
- 2 To switch on the sound, you can:
 - press **MUTE** again;
 - adjust the volume controls;
 - change source

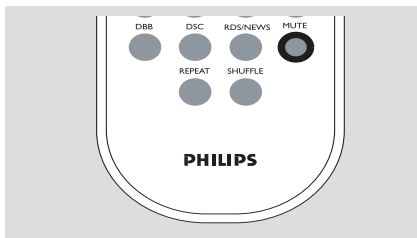

Sound control

DSC

Digital **S**ound **C**ontrol enables you to select predefined sound settings.

- Press **DSC** repeatedly to select the desired sound setting: **ROCK**, **JAZZ**, **POP**, **CLASSIC**

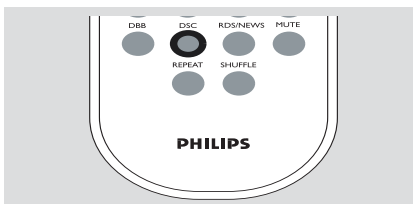

DBB

- Press **DBB** (**D**ynamic **B**ass **B**oost) once or more to switch bass enhancement on or off.
 - **DBB** appears if **DBB** is activated

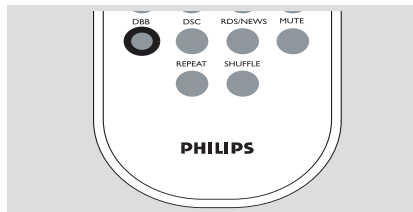

Displaying the clock

- During playback, press **DISPLAY/CLOCK** on the remote control repeatedly to switch between the clock display and the playback display.

Notes:

- When playing **MP3** files, you will get track information (**ID3 tag**) by pressing **DISPLAY/ CLOCK**.

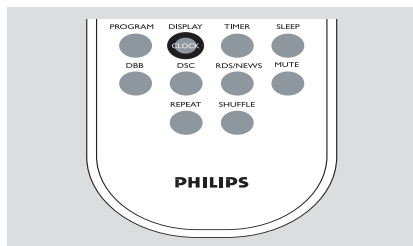

Discs for playback

With this system, you can play

- all pre-recorded audio CDs (CDDA)
- all finalized audio CD-Rs and CD-RWs
- MP3/WMA-CDs (CD-Rs/CD-RWs with MP3/WMA files)



IMPORTANT!

– This system is designed for regular discs. Therefore, do not use any accessories such as disc stabilizer rings or disc treatment sheets, etc.

About MP3/WMA

The music compression technology MP3 (MPEG1 Audio Layer 3) and WMA (Windows Media Audio) significantly reduces the digital data of an audio CD while maintaining CD quality sound.

Windows Media Audio® is a registered trademark of Microsoft Corporation.

Supported formats:

- Disc format ISO9660, Joliet, UDF (created on Adaptec Direct CD) and multi-session CDs
- MP3 bit rate (data rate): 32-320 Kbps and variable bit rate
- Directory nesting up to a maximum of 8 levels
- Max. track number plus album: 500
- WMA v9 or earlier



The system will not play or support the following:

- Empty albums: an empty album is an album that does not contain MP3/WMA files, and will not be shown in the display.
- Non-supported file formats are skipped. This means that e.g.: Word documents .doc or MP3 files with extension .dlf are ignored and will not be played.
- DRM protected WMA files
- WMA files in Lossless or VBR format

IMPORTANT!

- Make sure that the file names of MP3 files end with .mp3.
- For DRM protected WMA files, use Windows Media Player 10 (or later) for CD burning/conversion. Visit www.microsoft.com for details about Windows Media Player and WM DRM (Windows Media Digital Rights Management).

Playing discs

- 1 Press **SOURCE** once or more to select **CD** (or **CD** on the remote control)
→ The CD icon  appears
- 2 Press **CD OPEN•CLOSE**  to open the CD compartment.
→ **OPEN** is displayed

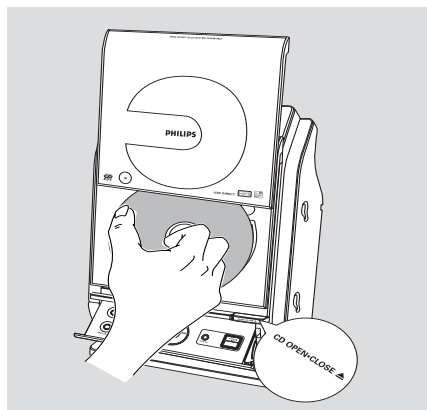

- 3 Insert a disc with the printed side facing up.
Press **CD OPEN•CLOSE**  again to close the compartment
→ **READING** is displayed as the CD player scans the contents of a disc
→ **Audio CD**: the total number of tracks and playing time are shown
MP3/WMA: Display shows current album number "A x x" and current track number "T x xx"

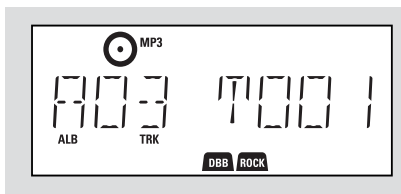

Helpful hints:

– If you have not organized MP3/WMA files into any albums on your disc, an album “00” will be automatically assigned for all those files.

- 4 Press ► || to start playback
→ Display shows current track number and elapsed playing time

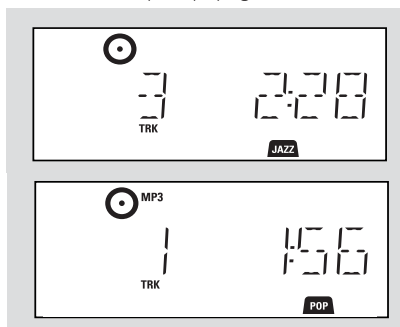

- 5 To pause playback, press ► ||. To resume playback, press the button again
6 To stop playback, press **STOP ■**

Helpful hints:

CD playwill also stop when

- the CD door is opened
- the disc has reached the end
- you select another source: **TUNER, USB or AUX**

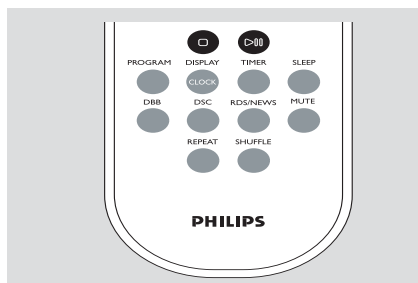
**Selecting and searching****Selecting a different track**

- Press ◀◀ / ▶▶ once or repeatedly until the desired track number appears in the display
MP3/WMA: → Track information scrolls briefly

MP3/WMA:

- Press **ALBUM/ PRESET** once or more to select the next or previous album
→ Track information scrolls briefly
or
- In the stop position, press **ALBUM/ PRESET** and ◀◀ / ▶▶ to select the desired album and track
→ **MP3/WMA:** Display shows current album/ track number

Finding a passage within a track during playback

- 1 During playback, press and hold ◀◀ / ▶▶
→ The CD plays at a high speed
- 2 When you recognize the passage you want, release ◀◀ or ▶▶
→ Normal playback resumes

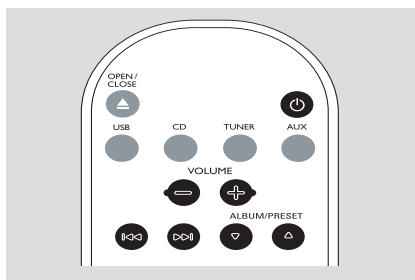

Programming tracks

You may store up to 40 tracks in the desired sequence. If you like, store any track more than once.

- In the stop position, press **PROGRAM** to start programming
 - **P** flashes
 - **Audio CD**: Display shows *PROG* and current track number
 - MP3/WMA**: Display shows current album/track number

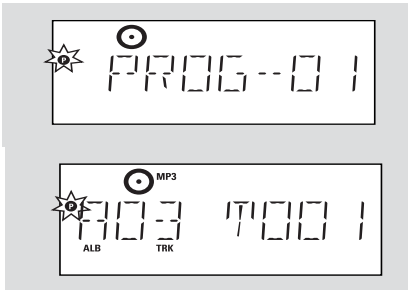

- Press **◀◀ / ▶▶** once or repeatedly until the desired track number appears in the display
- MP3/WMA**: press **ALBUM/ PRESET** and **◀◀ / ▶▶** to select the desired album and track
- Press **PROGRAM** to confirm
 - Display shows briefly the number of tracks programmed
 - Then, the display shows the track number you just stored

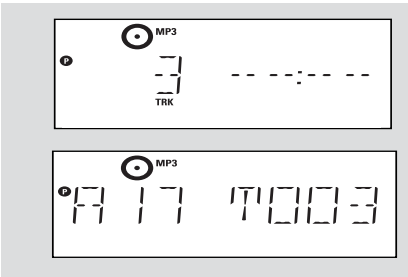

- Repeat steps 2-3 to select and store all desired tracks.
 - *FULL* is displayed if you attempt to program more than 40 tracks
- Press **▶||** play the program

Helpful hints:

– The set will return to the stop position if no button is pressed within 90 seconds.

P disappears. To resume programming, press **PROGRAM**.

– **MP3/WMA**: When playing a program, use of **ALBUM/ PRESET** are void.

Erasing the program

You can erase the contents of the memory by:

- Press **STOP** ■
 - once if in the stop position;
 - twice during playback;
- Press **STANDBY-ON** ⏻
- Select another sound source
- Open the CD door
 - **P** disappears. *CLEAR* scrolls

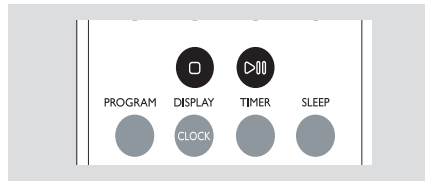

Different play modes: REPEAT, SHUFFLE

REPEAT TRACK – plays the current track continuously

REPEAT ALL – plays the entire disc/program continuously

SHUFFLE – plays all the tracks in random order

- 1 During playback, press once or more **REPEAT** or **SHUFFLE** to select play modes
- 2 To return to normal playback, press **REPEAT** or **SHUFFLE** repeatedly until the various modes are no longer displayed

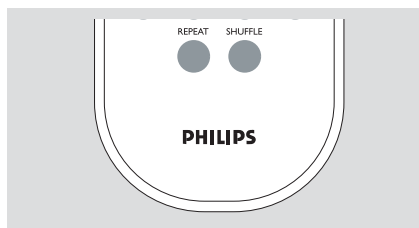

Helpful hints:

- In the shuffle mode, press **▶▶|** to select tracks.

Display track information (MP3/WMA only)

The ID3 tag is part of an MP3/WMA file and contains various track information such as the track's title or the artist's name.

- During playback, press **DISPLAY/CLOCK** repeatedly on the remote control
→ Display show title name, album name and ID3 tag information

Helpful hints:

- Complete the ID3 tag information with your MP3/WMA encoder software before burning the MP3/WMA-CD.

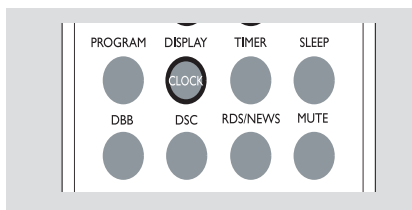

Tuning to radio stations

- 1 Press **SOURCE** once or more to select **TUNER** (or **TUNER** on the remote control)
- 2 Press **TUNER** on the remote control repeatedly to select your desired waveband, FM or MW
→ Display shows: , radio station frequency, waveband and if programmed, a preset number

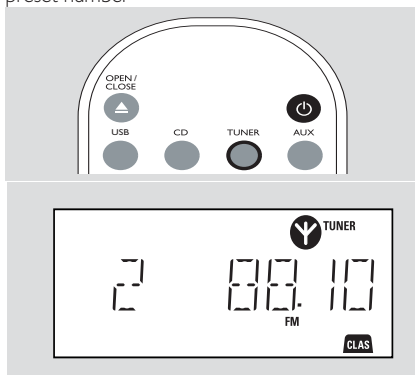

- 3 Press and hold **I◀◀ / ▶▶I** until **SEARCH** appears
→ The radio automatically tunes to a station with sufficient reception. Display shows **SEARCH** during automatic tuning
→ **FM**: If a station is received in stereo,  is shown
- 4 Repeat step 3 if necessary until you find the desired station.
- To tune to a weak station, press **I◀◀ / ▶▶I** briefly and repeatedly until you have found optimal reception.

Programming radio stations

You can store up to a total of 40 radio stations (FM and MW) in the memory, manually or automatically (Autostore).

Autostore: Automatic programming

Automatic programming will start from preset 1 or a chosen preset number. From this preset number upwards, former programmed tuner stations will be erased. The set will only program stations which are not in the memory already.

- 1 Press the **ALBUM/ PRESET** buttons once or more to select the preset number where programming should start.

Note:

– If no tuner preset number is selected, default is preset 1 and all your presets will be erased.

- 2 Press and hold **PROGRAM** until **AUTO** appears
→ **P** flashes
→ Available stations are programmed: FM stations followed by MW stations
→ After all stations are stored, the last preset station will then be played

Manual programming

- 1 Tune to your desired station (see **Tuning to radio stations**)
- 2 Press **PROGRAM** to activate programming
→ **P** flashes
- 3 Press **ALBUM/ PRESET** to allocate a number from 1 to 40 to this station.
- 4 Press **PROGRAM** to confirm
→ Display shows the preset number, waveband and the frequency of the preset station
- 5 Repeat steps 1-4 to store other stations
- You can erase a preset station by storing another frequency in its place

To listen to a preset station

- Press the **ALBUM/ PRESET** buttons once or more until the desired preset station is displayed.

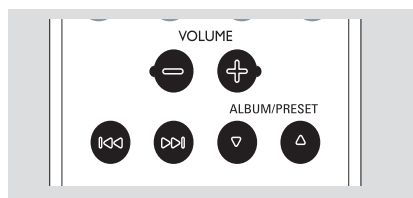

Changing tuning grid *(not available for all versions)*

In North and South America, the frequency step between adjacent channels in the MW band is 10 kHz (9 kHz in some areas).

Changing the tuning grid will erase all previously stored preset radio stations.

- 1 Select **TUNER** source
- 2 Press **STOP** on the set for at least 5 seconds.
→ The display will show "GRID 9" or "GRID 10".

Note:

- GRID 9 and GRID 10 indicate that the tuning grid is in step of 9 kHz and 10 kHz respectively.
- The FM tuning grid also will be changed from 50 kHz to 100 kHz or vice versa.

Using a USB mass storage device

By connecting a USB mass storage device to the Hi-Fi system, you can enjoy the device's stored music through the powerful speakers of Hi-Fi system.

Playing a USB mass storage device

Compatible USB mass storage devices

- With the Hi-Fi system, you can use
- USB flash memory (USB 2.0 or USB1.1)
 - USB flash players (USB 2.0 or USB1.1)
 - memory cards (requires an additional card reader to work with this Hi-Fi system)

Note:

– In some USB flash players (or memory devices), the stored contents are recorded using copyright protection technology. Such protected contents will be unplayable on any other devices (such as this Hi-Fi system).

Supported formats:

- USB or memory file format FAT12, FAT16, FAT32 (sector size: 512 - 65,536 bytes)
- MP3 bit rate (data rate): 32-320 Kbps and variable bit rate
- WMA v9 or earlier
- Directory nesting up to a maximum of 8 levels
- Number of albums/ folders: maximum 99
- Number of tracks/titles: maximum 999
- ID3 tag v2.0 or later
- File name in Unicode UTF8 (maximum length: 128 bytes)

The system will not play or support the following:

- Empty albums: an empty album is an album that does not contain MP3/WMA files, and will not be shown in the display.
- Non-supported file formats are skipped. This means that e.g.: Word documents .doc or MP3 files with extension .dlf are ignored and will not be played.
- AAC, WAV, PCM audio files
- DRM protected WMA files
- WMA files in Lossless format

How to transfer music files from PC to a USB mass storage device

By dragging and dropping music files, you can easily transfer your favorite music from PC to a USB mass storage device.

For the flash player, you can also use its music management software for the music transfer.

However, those WMA files may be unplayable for compatibility reasons.

How to organize your MP3/WMA files on the USB mass storage device

This Hi-Fi system will browse the MP3/WMA files in the folders/sub-folders/titles order.

Example:

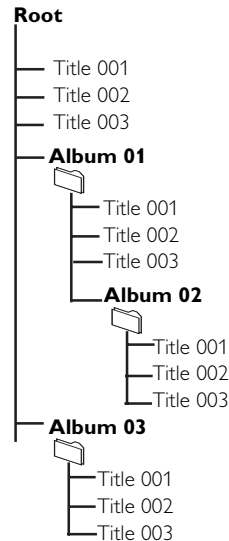

Organize your MP3/WMA files in different folders or subfolders as required.

Note:

- If you have not organized MP3/WMA files into any albums on your disc, an album "00" will be automatically assigned for all those files.
- Make sure that the file names of MP3 files end with .mp3. and the file names of WMA files end with .wma.
- For DRM protected WMA files, use Windows Media Player 10 (or later) for conversion. Visit www.microsoft.com for details about Windows Media Player and WM DRM (Windows Media Digital Rights Management).

- 1 Check the USB device has been properly connected. (See **Installation: Connecting an additional appliance**)
- 2 Press **SOURCE** once or more to select **USB** (or **USB** on the remote control)
 - The icon  appears

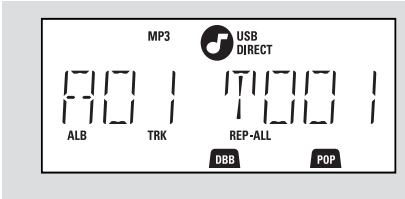

- **NO AUDIO** appears if no audio file is found in the USB device
- 3 Play the USB's audio files as you do with the albums/tracks on a CD (See **CD**)

Note:

- For compatibility reasons, the album/track information may differ from what it is displayed through flash players' music management software.
- File names or ID3 tags will be displayed as ----- if they are not in English.

AUX (Listening to an external source)

You can listen to the sound of the connected external device through your MCM275

- 1 Check the external device has been properly connected (See **Installation, Connecting an additional appliance**)
- 2 Press **SOURCE** once or more to select **AUX** (or **AUX** on the remote control)
- 3 To avoid noise distortion, turn down the volume on your external device
- 4 Press the **PLAY** key on the connected device to start playback
- 5 To adjust the sound and volume, use the sound controls on your external device and the MCM275

Setting the timer

The set can be used as an alarm clock, whereby the selected source (CD, TUNER or USB) starts playback at a preset time. **Make sure the clock is set before using the timer.**

- 1 Press and hold **TIMER** on the remote control until **SET TIMER** appears
 →  flashes. **SELECT SOURCE** scrolls
 → Display shows current source **CD, TUNER** or **USB**
- 2 Press **SOURCE** on the set repeatedly to select the source (or press **CD, TUNER** or **USB** on the remote control)
- 3 Press **TIMER** to confirm
 → The hours digits start flashing

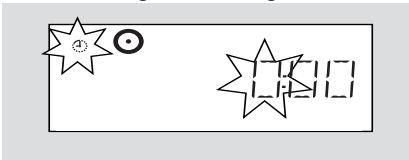

- 4 Hold down or press **VOLUME +/-** repeatedly to set the hours (or turn **VOLUME** on the set)
- 5 Press **TIMER** to confirm
 → The minutes digits start flashing
- 6 Hold down or press **VOLUME +/-** repeatedly to set the minutes (or turn **VOLUME** on the set)
- 7 Press **TIMER** to confirm
 → The timer is now set and activated
 → At the set alarm time, the CD, TUNER or USB will switch on (volume level: max. 20)

Note:

– The set will exit from the timer setting mode if no button is pressed within 90 seconds.

Activating and deactivating TIMER

- Press **TIMER** on the remote repeatedly to activate or deactivate the timer:
 → If activated, the last set source and start time are displayed
 → If deactivated, "TIMER OFF" appears

Helpful hints:

The timer will not work at the set time if

- the set is switched on
- the timer is deactivated

The set will switch to Tuner source automatically if:

- no CD is inserted when the selected source is CD;
- no USB device is connected when the selected source is USB

SLEEP

You can set a certain period of time after which the set will switch to standby.

- On the remote control, press **SLEEP** repeatedly to select the desired time period options (in minutes):
 → Display shows in sequence: **Sleep 90, 75, 60, 45, 30, 15**
 → Display shows the selected option briefly and returns to its previous status. The icon **zzZ** appears

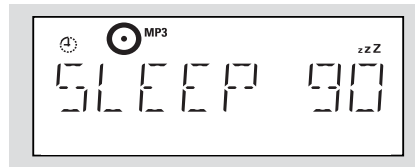

To deactivate the sleep timer, press **SLEEP** again

→ The icon **zzZ** disappears

or

Press **STANDBY-ON** to switch the set to standby (or  on the remote control)

Helpful hints:

– The SLEEP function does not affect your alarm time setting.

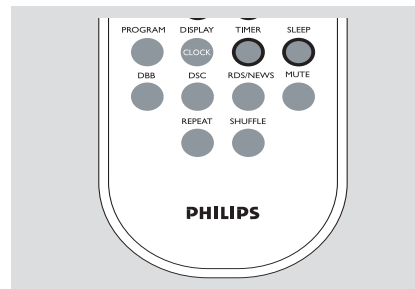

Specifications

AMPLIFIER

Output power 2 x 5 W RMS
..... 10 W + 10 W MPO
Signal-to-noise ratio ≥ 75 dBA
Frequency response 50 – 20,000 Hz, ± 3 dB
Input sensitivity AUX 0.5 V (max. 2 V)
Impedance loudspeakers $\geq 4 \Omega$
Impedance headphones 32Ω -1000 Ω
..... $<0.5W$

CD PLAYER

Frequency range 30 – 18000 Hz
Signal-to-noise ratio 75 dBA

TUNER

FM wave range 87.5 – 108 MHz
MW wave range (9 kHz) 531 – 1602 kHz
(10 kHz) 530 – 1700 kHz
Number of presets 40
Antenna
FM 75 Ω wire
MW Loop antenna

USB PLAYER

USB 12Mb/s,V1.1
..... support MP3 and WMA files
Number of albums/ folders maximum 99
Number of tracks/titles maximum 999

SPEAKERS

Bass reflex system
Dimensions (w x h x d) 160 x 269 x 90 (mm)

GENERAL INFORMATION

AC Power 110 – 127 / 220 – 240 V;
..... 50/60 Hz Switchable
Dimensions (w x h x d, with/without the stand)
..... 194 x 285 x 118/194 x 269 x 90 (mm)
Weight(with/without speakers) 3.8 / 2.2 kg
Standby power consumption <5 W

Specifications and external appearance are subject to change without notice.

Maintenance

Cleaning the Cabinet

- Use a soft cloth slightly moistened with a mild detergent solution. Do not use a solution containing alcohol, spirits, ammonia or abrasives.

Cleaning Discs

- When a disc becomes dirty, clean it with a cleaning cloth. Wipe the disc from the centre out.
- Do not use solvents such as benzene, thinner, commercially available cleaners, or antistatic spray intended for analogue records.



Cleaning the disc lens

- After prolonged use, dirt or dust may accumulate at the disc lens. To ensure good playback quality, clean the disc lens with Philips CD Lens Cleaner or any commercially available cleaner. Follow the instructions supplied with cleaner.

WARNING

Under no circumstances should you try to repair the system yourself, as this will invalidate the warranty. Do not open the system as there is a risk of electric shock.

If a fault occurs, first check the points listed below before taking the system for repair. If you are unable to remedy a problem by following these hints, consult your dealer or Philips for help.

Problem	Solution
"NO DISC" is displayed.	<ul style="list-style-type: none"> ✓ Insert a disc. ✓ Wait until the moisture condensation at the lens has cleared. ✓ Replace or clean the disc, see "Maintenance". ✓ Use a finalised CD-RW or a correct MP3/WMA-CD format disc.
Some files on the USB device are not displayed.	<ul style="list-style-type: none"> ✓ Check if the number of folders exceeds 99 or the number of titles exceeds 999
Radio reception is poor.	<ul style="list-style-type: none"> ✓ If the signal is too weak, adjust the antenna or connect an external antenna for better reception. ✓ Increase the distance between the Micro HiFi System and your TV or VCR.
The system does not react when buttons are pressed.	<ul style="list-style-type: none"> ✓ Remove and reconnect the AC power plug and switch on the system again.
Sound cannot be heard or is of poor quality.	<ul style="list-style-type: none"> ✓ Adjust the volume. ✓ Disconnect the headphones. ✓ Check that the speakers are connected correctly. ✓ Check if the stripped speaker wire is clamped. ✓ Make sure the MP3-CD was recorded within 32~256 kbps bit rate with sampling frequencies at 48 kHz, 44.1 kHz or 32 kHz.
The left and right sound outputs are reversed.	<ul style="list-style-type: none"> ✓ Check the speaker connections and location.

Troubleshooting

The remote control does not function properly.

- ✓ Select the source (CD or TUNER, for example) before pressing the function button (▶▶||, ◀◀◀, ▶▶▶).
- ✓ Reduce the distance between the remote control and the system.
- ✓ Insert the battery with its polarities (+/- signs) aligned as indicated.
- ✓ Replace the battery.
- ✓ Point the remote control directly toward IR sensor on the front of the system.

The timer is not working.

- ✓ Check the set is switched off
- ✓ Set the clock correctly.
- ✓ Press TIMER to switch on the timer:

The Clock/Timer setting is erased.

- ✓ Power has been interrupted or the power cord has been disconnected. Reset the clock/timer:

How to mount your MCM275 onto walls

IMPORTANT!

- The wall mounting instructions are for the use of the qualified wall mounting person only!
- Ask a qualified person to help you with the wall mounting, which includes drilling holes on the wall and mounting the set onto walls.

What's in the supplied mounting kits

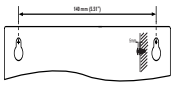

1 x template
(Wall mounting instructions)



2 x screws

What else you'll need

- Drilling tools (e.g. electric drill)

Preparation

- 1 To find a suitable location for mounting, try your necessary rear connections (see the chapter **Installation**).
- 2 Ask a qualified person to help you with the wall mounting, who should:
 - to avoid unexpected damage, learn about the piping, wiring and other relevant information inside your walls;
 - according to the drilling requirements, choose suitable drilling tools;
 - take other precautions necessary for the wall mounting work.

Mounting your MCM275

- 1 Align the template in the chosen location on a wall. Use a pencil to mark the drilling positions (as shown)

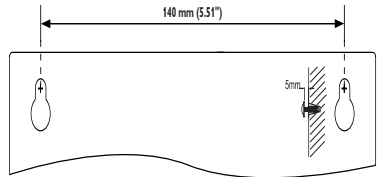

- 2 Drill two 6mm diameter holes as marked
- 3 Secure the dowels and screws in the holes respectively, leaving the screws 5mm proud of the wall

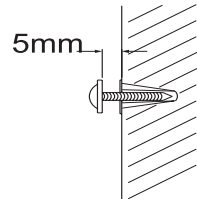

- 4 To detach the stand,
 - a. As shown, hold down the **▲ PRESS** buttons
 - b. Move out the stand to detach

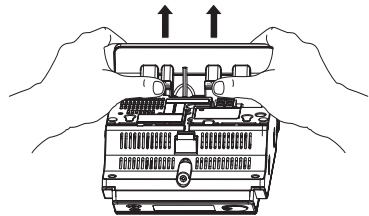

- 5 Hang the unit on the fastening screws
- 6 As shown, hook and mount the speakers in place

