

Register your product and get support at
www.philips.com/welcome

HTS3181



EN User manual

ES Manual del usuario

PT-BR Manual do Usuário

PHILIPS

“Evite o uso prolongado do aparelho com volume superior a 85 decibéis pois isto poderá prejudicar a sua audição.”

Nível de Decibéis	Exemplos
30	Biblioteca silenciosa, sussurros leves
40	Sala de estar, refrigerador, quarto longe do trânsito
50	Trânsito leve, conversação normal, escritório silencioso
60	Ar condicionado a uma distância de 6 m, máquina de costura
70	Aspirador de pó, secador de cabelo, restaurante ruidoso
80	Tráfego médio de cidade, coletor de lixo, alarme de despertador a uma distância de 60 cm
OS RUÍDOS ABAIXO PODEM SER PERIGOSOS EM CASO DE EXPOSIÇÃO CONSTANTE	
90	Metrô, motocicleta, tráfego de caminhão, cortador de grama
100	Caminhão de lixo, serra elétrica, furadeira pneumática
120	Show de banda de rock em frente às caixas acústicas, trovão
140	Tiro de arma de fogo, avião a jato
180	Lançamento de foguete

Contents

1 Important	4
Safety and important notice	4
Trademark notice	5

2 Your Home Theater System	6
Feature highlights	6
Product overview	6

3 Connect	9
Place the Home Theater System	9
Connect video cables	9
Connect speakers and subwoofer	11
Connect radio antenna	11
Connect audio cables/other devices	11
Connect power cord	12

4 Get started	13
Insert the remote control batteries	13
Find the correct viewing channel	14
Select menu display language	14
Turn on Progressive Scan	14
Change speaker settings	15
Select a play source	16

5 Play	17
Play a disc	17
Play video	17
Play music	20
Play photo	21
Play from USB device	23
Play from radio	23

6 Adjust sound	25
Control the volume	25
Select surround sound	25
Select a preset sound	25
Adjust microphone volume level	26
Karaoke settings	26
Turn off vocal (cancel voice)	26

7 Adjust settings	27
General setup	27
Audio setup	28
Video setup	29
Preferences	30

8 Additional Information	32
Update software	32
Care	32

9 Specifications	33
-------------------------	----

10 Troubleshooting	35
---------------------------	----

11 Glossary	37
--------------------	----

1 Important

Safety and important notice



Warning

- Risk of overheating! Never install the Home Theater System in a confined space. Always leave a space of at least 4 inches around the Home Theater System for ventilation. Ensure curtains or other objects never cover the ventilation slots on the Home Theater System.
- Never place the Home Theater System, remote control or batteries near naked flames or other heat sources, including direct sunlight.
- Only use this Home Theater System indoors. Keep this Home Theater System away from water, moisture and liquid-filled objects.
- Never place this Home Theater System on other electrical equipment.
- Keep away from this Home Theater System during lightning storms.
- Where the mains plug or an appliance coupler is used as the disconnect device, the disconnect device shall remain readily operable.
- Visible and invisible laser radiation when open. Avoid exposure to beam.

Recycle notice



This electronic equipment contains a large number of materials that can be recycled or reused if disassembled by a specialized company. If you are disposing of an old machine, please take it to a recycling center. Please observe the local regulations regarding disposal of packaging materials, exhausted batteries and old equipment.

Copyright notice



Be responsible
Respect copyrights

This product incorporates copyright protection technology that is protected by method claims of certain U.S. patents and other intellectual property rights owned by Macrovision Corporation and other rights owners. Use of this copyright protection technology must be authorised by Macrovision Corporation, and is intended for home and other limited viewing uses only unless otherwise authorised by Macrovision Corporation. Reverse engineering or disassembly is prohibited.

About Progressive Scan

Consumers should note that not all high definition television sets are fully compatible with this product and may cause artifacts to be displayed in the picture. In case of 525 or 625 progressive scan picture problems, it is recommended that the user switch the connection to the 'standard definition' output. If there are questions regarding our TV set compatibility with this model 525p and 625p DVD player, please contact our customer service center.

Trademark notice



Manufactured under license from Dolby Laboratories. Dolby, Pro Logic and the double-D symbol are trademarks of Dolby Laboratories.



DivX, DivX Ultra Certified, and associated logos are trademarks of DivX, Inc. and are used under license.

Official DivX® Ultra Certified product.

Plays all versions of DivX® video (including DivX® 6) with enhanced playback of DivX® media files and the DivX® Media Format.

Plays DivX® video with menus, subtitles and audio tracks.



Windows Media and the Windows logo are trademarks, or registered trademarks of Microsoft Corporation in the United States and/or other countries.



The USB-IF Logos are trademarks of Universal Serial Bus Implementers Forum, inc.



ENERGY STAR and the ENERGY STAR mark are registered U.S. marks.



2 Your Home Theater System

Congratulations on your purchase, and welcome to Philips! To fully benefit from the support that Philips offers, register your product at www.philips.com/welcome.

Feature highlights

Listen to rich uncompressed multi-channel surround sound

This Home Theater System supports 5.1 channels of uncompressed audio that delivers a real-to-life sound experience as if you are listening to it live.

USB direct

Simply plug your USB device into the USB jack to play your MP3/WMA/JPEG/DivX files.

Sync the audio output with the video play

Synchronize audio and video by delaying the audio output if the video signal sent to the TV is slower than the audio streams.

Screen Fit

View the movie in full screen display on any TV.

Karaoke scoring function

Karaoke scoring gives a score and a comment for each performance. Have your singing performance scored for even more karaoke fun at home!

Region codes

You can play discs with the following region codes.



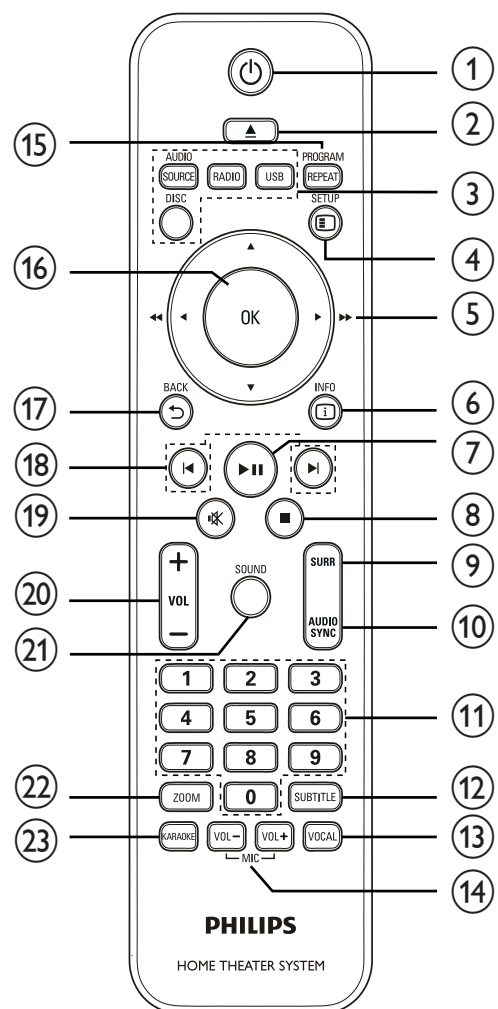

DVD region code	Countries
	Latin America

Product overview

Remote control



- ① **⏻ (Standby-On)**
 - Turns on the Home Theater System or switches to standby mode.

- ② ▲ (Open/Close)
- Opens or closes the disc compartment.
- ③ Source buttons
- **AUDIO SOURCE:** Selects an audio input source.
 - **RADIO:** Switches to FM band.
 - **USB:** Switches to the USB source.
 - **DISC:** Switches to the disc source.
- ④  **SETUP**
- Accesses or exits the setup menu.
- ⑤ ▲▼◀▶ (Navigation buttons)
- Navigates through the menus.
 - Press left and right for fast backward or forward search.
 - In radio mode, press up and down to tune the radio frequency.
 - In radio mode, press left or right to start auto search.
- ⑥  **INFO**
- For discs, displays information about the current status or the disc.
 - For slideshows, displays a thumbnail view of photo files.
- ⑦ ▶|| (Play/Pause)
- Starts, pauses or resumes disc play.
 - In radio mode, automatically tunes radio stations during first-time setup.
- ⑧ ■ (Stop)
- Stops disc play.
 - In radio mode, erases the current preset radio station.
- ⑨ **SURR (Surround Sound)**
- Switches to supported surround sound or stereo sound.
- ⑩ **AUDIO SYNC**
- Selects an audio language or channel on a disc.
 - Press and hold to access the setting for audio sync, then press **VOL +/-** to set the audio delay time.
- ⑪ **Numeric buttons**
- Selects an item to play.
- ⑫ **SUBTITLE**
- Selects the subtitle language on a disc.
- ⑬ **VOCAL**
- Changes the audio channel of a karaoke disc.
- ⑭ **MIC (VOL +/-)**
- Increases or decreases microphone volume.
- ⑮ **REPEAT / PROGRAM**
- Selects or turns off repeat or shuffle mode.
 - In radio mode, resets the list of preset stations: press to manually reset; press and hold to automatically reset.
- ⑯ **OK**
- Confirms an entry or selection.
- ⑰  **BACK**
- Returns to a previous screen.
 - For DVD, goes to the title menu.
 - For VCD version 2.0 or SVCD with PBC turned on, returns to the menu during playback.
- ⑱  **(Previous/Next)**
- Skips to the previous or next title, chapter, or track.
- ⑲  **(Mute)**
- Mutes or restores audio output.
- ⑳ **VOL +/-**
- Increases or decreases volume.
- ㉑ **SOUND**
- Selects a predefined sound effect.
- ㉒ **ZOOM**
- Zooms in or out of the picture.
 - Fits the picture format to the TV screen (using zoom function: 1.3X and 1.6X).

23 KARAOKE

- Accesses or exits the karaoke menu.

Main unit

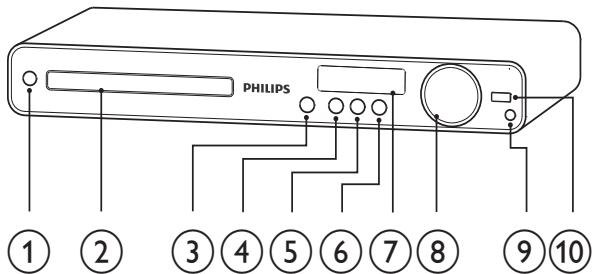

1 (Standby-On)

- Turns on the Home Theater System or switches to standby mode.

2 Disc compartment

3 (Open/Close)

- Opens or closes the disc compartment.

4 (Play/Pause)

- Starts, pauses or resumes disc play.
- In radio mode, automatically tunes radio stations during first-time setup.

5 (Stop)

- Stops disc play.
- In radio mode, erases the current preset radio station.

6 SOURCE

- Selects a media to play or listen to audio from the connected device.

7 Display panel

8 VOLUME

- Increases or decreases volume.

9 MIC

- Connects a microphone.

10 (USB)

- Connects a USB supported device.

3 Connect

Make the following connections to use your Home Theater System.

Basic connections:

- Video
- Speakers and subwoofer
- Power

Optional connections:

- Radio antenna
- Audio
 - Audio from TV
 - Audio from cable box/recorder/game console
- Other devices
 - USB device

Note

- Refer to the type plate at the back or bottom of the product for identification and supply ratings.
- Before you make or change any connections, ensure that all the devices are disconnected from the power outlet.

Place the Home Theater System

- Place the Home Theater System where it cannot be pushed, pulled over or knocked down. Do not place it in an enclosed cabinet.
- Be sure that you have full access to the power cord for easy disconnection of the Home Theater System from the power supply.

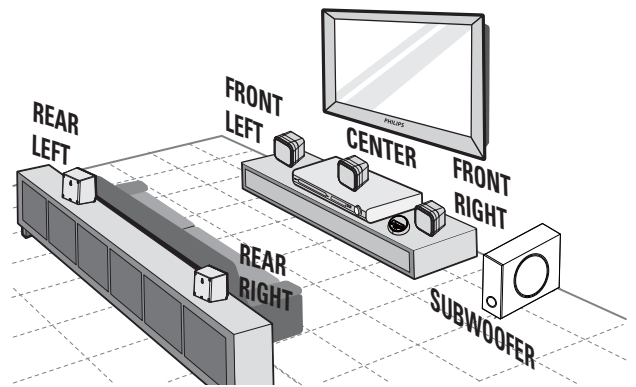

- 1 Place this Home Theater System near the TV.
- 2 Place the speakers system at normal listening ear-level and directly parallel to the listening area.
- 3 Place the subwoofer at the corner of the room or at least 3 feet away from the TV.

Tip

- To avoid magnetic interference or unwanted noise, never place this Home Theater System too close to any radiation devices.

Connect video cables

Connect this Home Theater System to TV to view disc play. Select the best video connection that the TV can support.

- Option 1: Connect to the VIDEO jack (for a standard TV).
- Option 2: Connect to the component video jacks (for a standard TV or Progressive Scan TV).

Note

- You must connect this Home Theater System directly to a TV.

Option 1: Connect to the Video (CVBS) jack

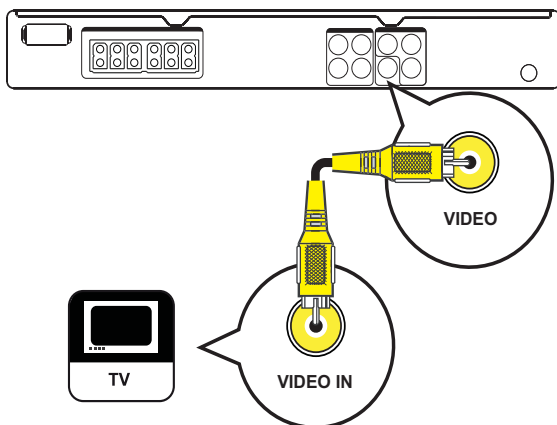

- 1 Connect a composite video cable to the **VIDEO** jack on this Home Theater System and the VIDEO input jack on the TV.

Note

- The video input jack on the TV might be labeled as A/V IN, VIDEO IN, COMPOSITE or BASEBAND.
- This type of connection provides standard picture quality.

Option 2: Connect to the component video jack

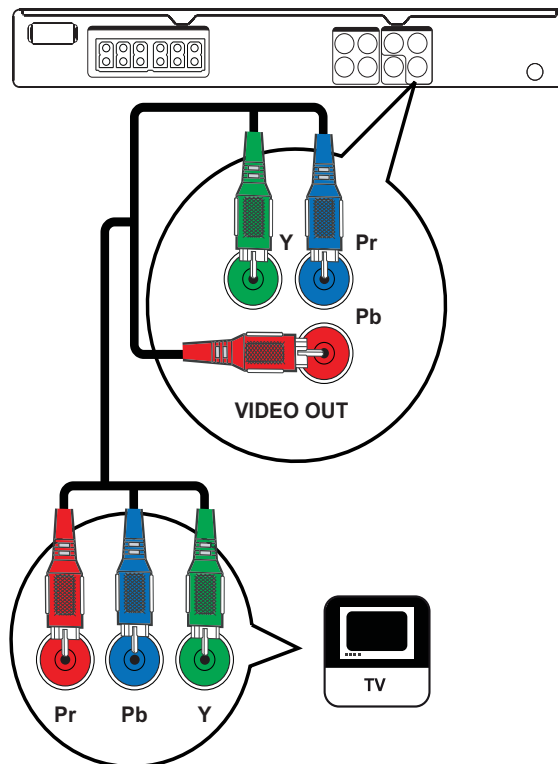

- 1 Connect the component video cable (not supplied) to the **Y Pb Pr** jacks on this Home Theater System and the COMPONENT VIDEO input jacks on the TV.
 - If a progressive scan TV is used, you may turn on the progressive scan mode. (see 'Get started' > 'Turn on Progressive Scan').

Note

- The component video input jack on the TV might be labeled as Y Pb/Cb Pr/Cr or YUV.
- This type of connection provides good picture quality.

Connect speakers and subwoofer

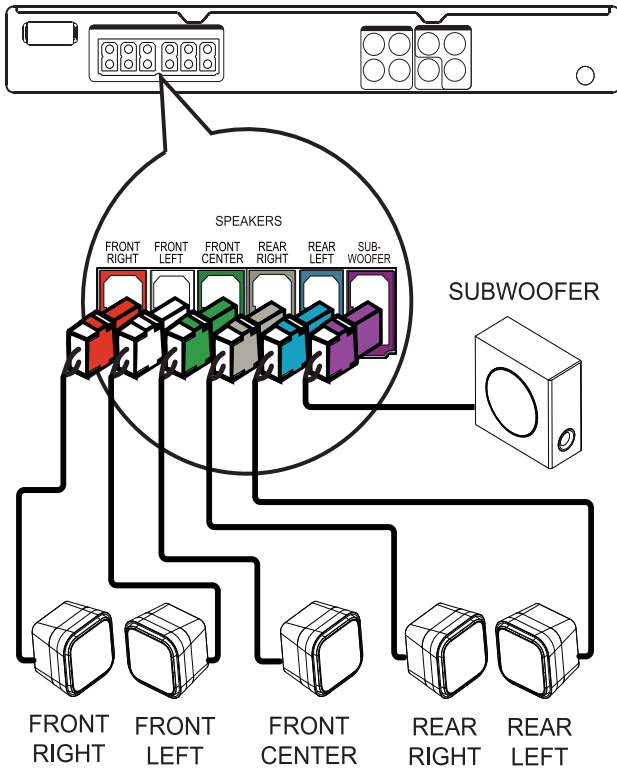

- 1 Connect the speakers and subwoofer to the matching jacks on the Home Theater System.



Note

- Ensure that the colors of the plugs and jacks are matched.

Connect radio antenna

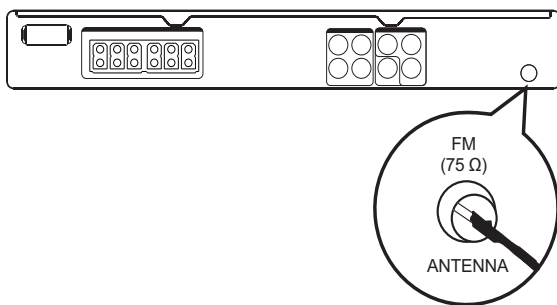

- 1 Connect the FM antenna to the **FM75Ω** jack on this Home Theater System (for some models, this cable is already connected).
- 2 Extend the FM antenna and fix its ends to the wall.



Tip

- For better FM stereo reception, connect to an external FM antenna.

Connect audio cables/other devices

Route the audio from other devices to this Home Theater System to enjoy audio play with multi-channel surround capabilities.

Connect audio from TV

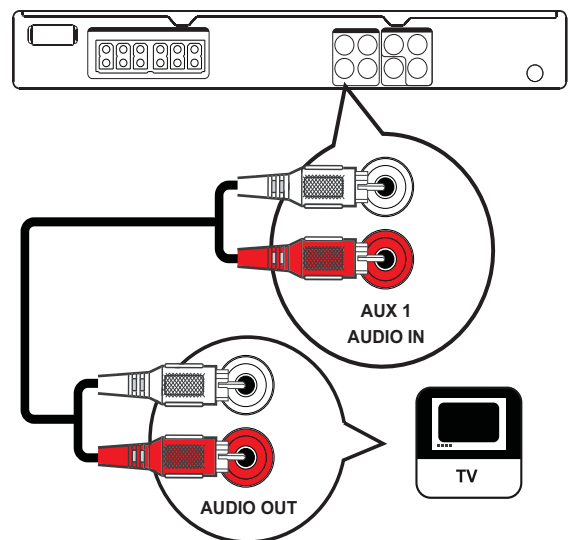

- 1 Connect the audio cables (not supplied) to the **AUDIO IN-AUX1** jacks on the Home Theater System and the **AUDIO** output jacks on the TV.

Note

- To listen to the audio output from this connection, press **AUDIO SOURCE** repeatedly until 'AUX1' is displayed on the display panel.

Connect audio from cable box/ recorder/game console

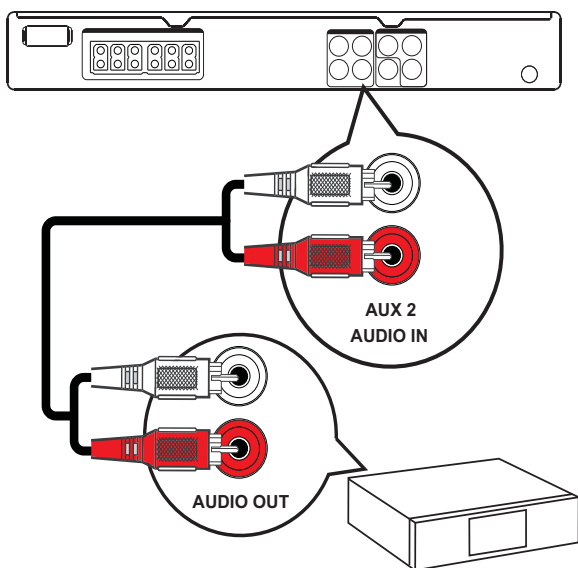

- 1 Connect the audio cables (not supplied) to the **AUDIO IN-AUX2** jacks on the Home Theater System and the **AUDIO** output jacks on the device.

Note

- To listen to the audio output from this connection, press **AUDIO SOURCE** repeatedly until 'AUX2' is displayed on the display panel.

Connect USB device

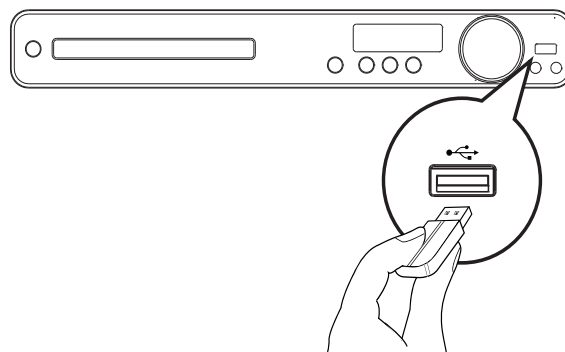

- 1 Connect the USB device to the **USB** jack on this Home Theater System.

Note

- This Home Theater System can only play/view MP3, WMA, DivX (Ultra) or JPEG files that are stored on such devices.
- Press **USB** to access the content and play the files.

Connect power cord

Warning

- Risk of product damage! Ensure that the power supply voltage corresponds to the voltage printed on the back or the underside of the Home Theater System.

- 1 Connect the power cord to the power outlet when all the required connections are done.
↳ The Home Theater System is ready to be set up for use.

4 Get started

Insert the remote control batteries

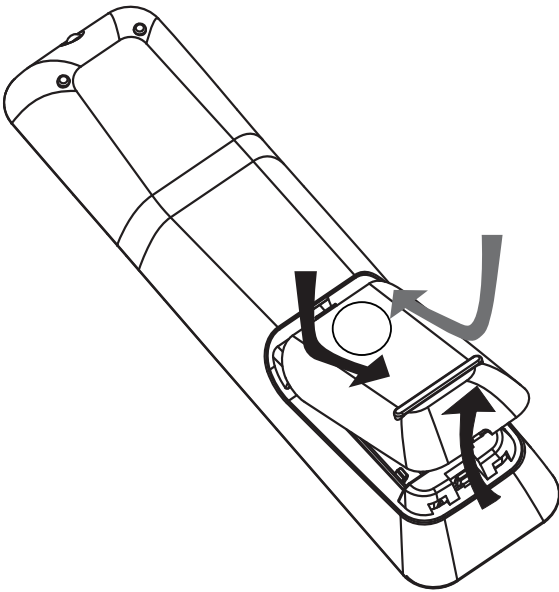

- 1 Slide the battery cover off the back of the remote control.
- 2 Insert the 2 supplied batteries (AAA). Be sure the + and - ends of the batteries line up with the markings inside the case.
- 3 Slide the cover back into position.

Note

- Do not mix batteries (old and new or carbon and alkaline, etc.).
- Remove batteries if they are exhausted or if the remote control is not to be used for a long time.
- Batteries contain chemical substances, they should be disposed of properly.

Control a play source

- 1 Press **RADIO**, **USB** or **DISC** button to select the source you wish to control.
- 2 Select the desired function (for example **◀**, **▶**).

Navigate through the menu

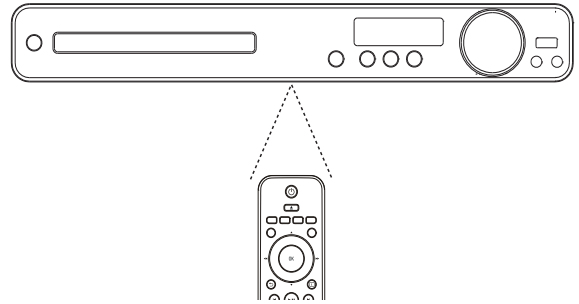

- 1 Point the remote control directly at the remote sensor on the Home Theater System and select the desired function.
- 2 Press the following buttons on the remote control to navigate through the on-screen menus.

Button	Action
▲▼	Move up or down
◀▶	Move left or right
OK	Confirm a selection
1 2 3 4 5 6 7 8 9 0	Enter numbers

Find the correct viewing channel

- 1 Press **⏻** to turn on the Home Theater System.
- 2 Press **DISC** to switch to disc mode.
- 3 Turn on the TV and switch to the correct video-in channel in one of the following ways:
 - Go to the lowest channel on your TV, then press the Channel Down button until you see the Philips screen.
 - Press **SOURCE** button repeatedly on the remote control of your TV.



Tip

- The video-in channel is between the lowest and highest channels and may be called FRONT, A/V IN, VIDEO, HDMI etc. See the TV user manual on how to select the correct input on the TV.

Select menu display language

General Setup	
Disc Lock	English
Display Dim	Español
OSD Language	Português
Screen Saver	
Sleep Timer	
DivX(R) VOD Code	

- 1 Press **DISC**.
- 2 Press **⏻** **SETUP**.
↳ **[General Setup]** menu is displayed.
- 3 Press **▶**.

- 4 Press **▲▼** to select **[OSD Language]** in the menu, then press **▶**.
 - The language options are different depending on your country or region. It may not correspond to the illustration shown here.
- 5 Press **▲▼** to select a language, then press **OK**.



Tip

- You can set the default language for DVD disc menu (see 'Adjust settings' > 'Preferences' > **[Disc Menu]**).

Turn on Progressive Scan

If the TV supports progressive scan output, you can connect this Home Theater System and the TV using component video connection. (see 'Connect video cables' > 'Option 2: Connect to the component video jack').

Video Setup	
TV System	On
TV Display	Off
Progressive	
Picture Settings	

- 1 Turn on the TV and ensure that the TV progressive scan mode is deactivated (see the TV user manual).
- 2 Switch the TV to the correct viewing channel for this Home Theater System.
- 3 Press **DISC**.
- 4 Press **⏻** **SETUP**.
- 5 Press **▼** to select **[Video Setup]** in the menu, then press **▶**.

- 6 Select **[Progressive]** > **[On]**, then press **OK**.
↳ A warning message is displayed.
- 7 To proceed, select **[Ok]** and press **OK**.
↳ The progressive setup is complete.

Note

- If a blank/distorted screen is displayed, wait for 15 seconds for the auto recover.
- If no picture displayed, turn off the progressive scan mode as follows: 1) Press **▲** to open the disc compartment. 2) Press **◀**. 3) Press **AUDIO SYNC**.

- 8 Press **⏏** **SETUP** to exit the menu.
- 9 You can now turn on the progressive scan mode on the TV.

Note

- During play, when progressive scan mode is on for both this Home Theater System and the TV, distorted picture may display. Turn off the progressive scan feature on both this Home Theater System and the TV.

Change speaker settings

Ideally, the distance between listening position and all the speakers should be the same. If not, change the speaker settings based on their distance from the listening position to obtain the best possible surround sound.

Audio Setup	
Speakers Volume	
Speakers Delay	
Night Mode	

- 1 Press **DISC**.
- 2 Press **⏏** **SETUP**.
- 3 Press **▼** to select **[Audio Setup]** in the menu, then press **▶**.
 - If the speaker setup option is not accessible, press **■** twice before you try the above steps again.

To set the speakers level

- 1 Select **[Speakers Volume]** in the menu, then press **▶**.

Speakers Volume Setup		
Front Left		0dB
Front Right		0dB
Center		0dB
Subwoofer		0dB
Rear Left		0dB
Rear Right		0dB

- 2 Press ◀▶ to change the volume level, then press **OK**.
 - ↳ The test tone is emitted from the speaker:
 - Repeat the above setting for other speakers until all the speakers output level sounds equally balance.
 - To exit the menu, press **⏏ SETUP**.

To set the output delay time (center and rear speakers only)

- 1 Select [**Speakers Delay**] in the menu, then press ▶.

Speakers Distance Setup		
Center	<input type="text"/>	OMS
Rear Left	<input type="text"/>	OMS
Rear Right	<input type="text"/>	OMS

- 2 Press ◀▶ to set the delay time, then press **OK**.
 - Repeat the above setting for other speakers until the sound output from different speakers reach the listening position at the same time.
 - To exit the menu, press **⏏ SETUP**.

Tip

- Set a longer delay time if the center speaker or rear speaker is closer to the listening position than the front speaker.
- Allow 1ms setting for every 1 foot distance between the speaker and the listening position.

Select a play source

On the main unit

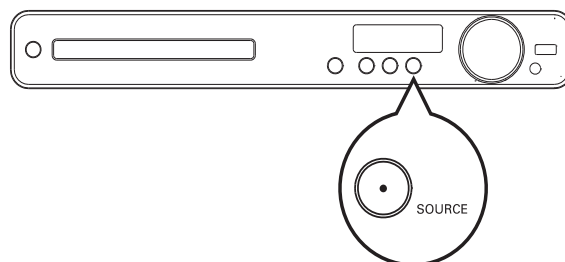

- Press **SOURCE** button repeatedly to select: **DISC > USB > FM > AUX 1 > AUX 2 > DISC ...**

On the remote control

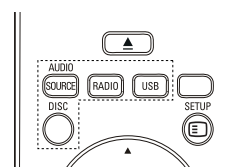

- Press **AUDIO SOURCE** repeatedly to switch to the connected audio source.

Display	Device connected to
AUX 1	AUDIO IN-AUX 1 jacks
AUX 2	AUDIO IN-AUX 2 jacks

- Press **RADIO** to switch to FM band.
- Press **USB** to switch to USB mode.
- Press **DISC** to switch to disc mode.

5 Play

Play a disc



Caution

- Never place any objects other than discs into the disc compartment.
- Never touch the disc optical lens inside the disc compartment.

- 1 Press **▲** to open the disc compartment.
- 2 Insert a disc with its label facing up.
 - For double-sided disc, load the side to play faces up.
- 3 Press **▲** to close the disc compartment and start disc play.
 - To view disc play, turn on the TV to the correct viewing channel for this Home Theater System.
 - To stop disc play, press **■**.



Note

- Check the types of discs supported (see 'Specifications' > 'Playback media').
- If the password entry menu is displayed, enter the password before you can play the locked or restricted disc.
- If you pause or stop a disc for about 15 minutes, the screen saver activates. To deactivate the screen saver, press **DISC**.
- After you pause or stop a disc and no buttons are pressed within 30 minutes, this Home Theater System automatically switches to standby mode.

Play video



Note

- For video disc, playback always resumes from the point where it was last stopped. To start play from the beginning, press **◀** while the message is displayed.

Control video play

- 1 Play a title.
- 2 Use the remote control to control the title.

Button	Action
▶ 	Starts, pauses or resumes disc play.
■	Stops disc play.
▶	Skips to the next title or chapter.
◀	Skips to the beginning of the current title or chapter. Press twice to jump to the previous title or chapter.
◀◀ / ▶▶	Searches fast-forward (right) or fast-backward (left). Press repeatedly to change the search speed.
▲ / ▼	Searches slow-forward (down) or slow-backward (up). Press repeatedly to change the search speed. For VCD, only slow-forward play is possible.

Change video play

- 1 Play a title.
- 2 Use the remote control to change the video play.

Button	Action
AUDIO	Selects an audio language or channel on a disc.
SYNC	
SUBTITLE	Selects the subtitle language on a disc.
REPEAT	Selects or turns off repeat or shuffle mode. Repeat options vary depending on the disc type. For VCDs, repeat play is only possible if the PBC mode is turned off.
ZOOM	Zooms in or out of the picture. To pan through the zoomed image, press the Navigation buttons .
INFO	Displays the current status or disc information. You can change the video play options here without interrupting disc play.

Note

- Some operations may not work with some discs. See the information accompanying the disc for details.

Access DVD menu

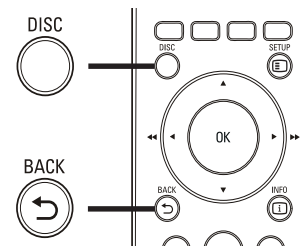

- 1 Press **DISC** to access disc main menu.
- 2 Select a play option, then press **OK**.
 - In some menus, press the **Numeric buttons** to input your selection.
 - To return to the title menu during play, press **BACK**.

Access VCD menu or preview menu

The PBC (Playback Control) for VCD is activated by default in the factory. When you load in a VCD, the contents menu is displayed.

- 1 Press **▲▼** or the **Numeric buttons** to select a play option, then press **OK** to start play.
 - If PBC is off, it skips the menu and starts play from the first title.
 - To return to the menu during play, press **BACK** (only possible if the PBC mode is on).
- 2 Press **DISC** to preview the contents of the disc.
 - To exit the menu, press **DISC**.

Select Digest Type:

Track Digest
Disc Interval
Track Interval

- 3 Select a preview play option, then press **OK**

[Track Digest]

Plays the first few seconds of each track in a disc.

[Disc Interval]

Divides the total disc time by six and play the first few seconds of these intervals.

[Track Interval]

Divides the current track by six and play the first few seconds of these intervals.

This option is not available in stop mode.

**Tip**

- You can change the PBC setting (see 'Adjust settings' > 'Preferences' > [PBC]).

Sync audio output with video play

If the video play is slower than the audio output (sound does not match with the pictures), you can delay the audio output to match the video.

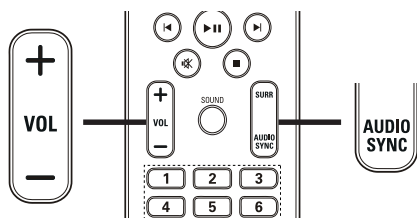

- Press and hold **AUDIO SYNC** until 'AUDIO SYNC XXX' is displayed. 'XXX' denotes the delay time.
- Within five seconds, press **VOL +/-** to set the delay time for audio output.

Note

- If the volume control is not used within 5 seconds, it resumes normal volume control function.

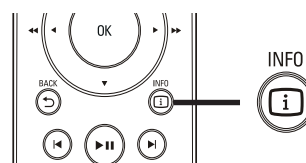
Quick skip play to a specific time

- During play, press **INFO**.
↳ The disc status menu is displayed.
- Press **▲▼** to view information, then press **OK**.
 - [TT Time] (title time)
 - [Ch Time] (chapter time)
 - [Disc Time] (disc time)
 - [Track Time] (track time)
- Press the **Numeric buttons** to enter the time where you want to skip to, then press **OK**.

Note

- The options are different depending on the disc type.

Repeat play a specific section

- During playback, press **INFO**.
↳ The disc status menu is displayed.
- Select **[Repeat]** in the menu, then press **▶**.
- Move to **[Repeat AB]** in the menu, then press **OK** to set the starting point.
- Press **OK** again to set the ending point.
↳ Repeat play starts.
- To cancel repeat play, select **[Off]** and press **OK**.

Note

- The marked section for repeat play is only possible within a track/title.

View video play from different camera angles

- 1 During play, press **INFO**.
↳ The disc status menu is displayed.
- 2 Select **[Angle]**, then press **▶**.
- 3 Press the **Numeric buttons** to select an angle.
↳ Play changes to the selected angle.

Note

- Applicable only to discs contain multi-angle scenes.

Play DivX® video

DivX video is a digital media format that retains high quality despite a high rate of compression. You can enjoy DivX video on this DivX® Certified Home Theater System.

- 1 Insert a disc or USB that contains the DivX videos.
- 2 Press **DISC** or **USB**.
↳ A contents menu is displayed.
- 3 Select a title to play, then press **▶||**.
- 4 Use the remote control to control the title.

Button	Action
AUDIO SYNC	Selects an audio language or channel.
SUBTITLE	Select DVD or DivX subtitle languages.
■	Stops play. For DivX Ultra video, press this button again to display the contents menu.
INFO	Displays DivX Ultra video information.

Note

- You can only play DivX videos that were rented or purchased with the DivX registration code of this Home Theater System (see 'Adjust settings' > 'General setup' > **[DivX(R) VOD Code]**).
- You can play DivX video files of up to 4GB.
- If the subtitle does not appear correctly, change the character set (see 'Adjust settings' > 'Preferences' > **[DivX Subtitle]**).
- This Home Theater System can display up to 45 characters in the subtitle.

Play music

Control audio track play

- 1 Play a track.
- 2 Use the remote control to control the track.

Button	Action
▶ 	Starts, pauses or resumes disc play.
■	Stops disc play.
▶	Skips to the next track.
◀	Skips to the beginning of the current track. Press twice to jump to the previous track.
1 2 3 4 5 6 7 8 9 0	Selects an item to play.
◀◀ / ▶▶	Searches fast-forward (right) or fast-backward (left). Press repeatedly to change the search speed.
REPEAT	Selects or turns off repeat or shuffle mode.

Play MP3/WMA music

MP3/WMA is a type of highly compressed audio file (files with .mp3 or .wma extensions).

- 1 Insert a disc or USB that contains the MP3/WMA music.
- 2 Press **DISC** or **USB**.
 - ↳ A contents menu is displayed.
- 3 Select a folder, then press **OK**.
- 4 Select a track to play, then press **▶||**.
 - To return to the main menu, press **↶ BACK** or press **▲** until 'Previous' folder is selected, then press **OK**.



Note

- For disc recorded in multiple sessions, only the first session is played.
- This Home Theater System does not support MP3PRO audio format.
- If any special characters are present in the MP3 track name (ID3) or album name, it might not be displayed correctly on the screen because these characters are not supported.
- Some WMA files are protected by Digital Rights Management and cannot be played on this Home Theater System.
- Folders/files that exceed the supported limit of this Home Theater System will not be displayed or played.



Tip

- You can select the display of data contents, view folders or files (see 'Adjust settings' > 'Preferences' > **[MP3/JPEG Display]**).

Play photo

Play photo as slideshow

This Home Theater System can play JPEG photos (files with .jpeg or .jpg extensions).

- 1 Insert a disc or USB that contains the JPEG photos.
- 2 Press **DISC** or **USB**.
 - ↳ Slideshow begins (for Kodak disc) or a contents menu (for JPEG disc) is displayed.
- 3 Select the folder/album you want to play.
 - To preview the photos in the folder/album, press **i INFO**.

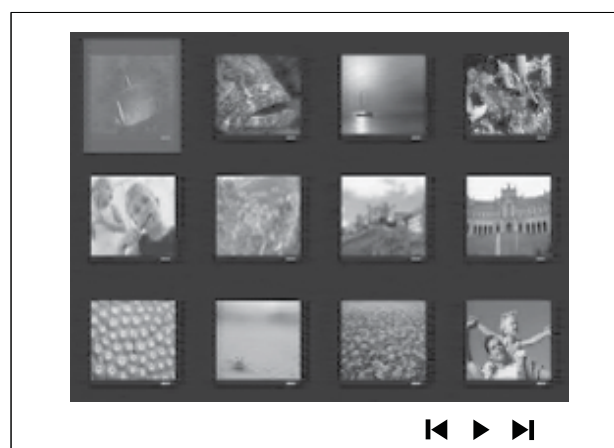

- To go to previous or next screen display, press **◀ / ▶**.
 - To select a photo, press the **Navigation buttons**.
 - To display the selected photo only, press **OK**.
- 4 Press **▶||** to start slideshow play.
 - To return to the menu, press **↶ BACK**.

Note

- You may require longer time to display the disc content on the TV due to the large number of songs/photos compiled onto one disc.
- If the JPEG photo is not recorded with an 'exif' type file, the actual thumbnail picture is not be shown on the display. It is replaced by a 'blue mountain' thumbnail picture.
- This Home Theater System can only display digital camera pictures according to the JPEG-EXIF format, typically used by almost all digital cameras. It cannot display Motion JPEG and pictures in formats other than JPEG, or sound clips associated with pictures.
- Folders/files that exceed the supported limit of this Home Theater System are not displayed or played.

Control photo play

- 1 Play photo slideshow.
- 2 Use the remote control to control the photo.

Button	Action
◀	Skips to the previous photo.
▶	Skips to the next photo.
▲	Rotates the photo clockwise.
▼	Rotates the photo anti-clockwise.
ZOOM	Zooms in or out of the picture. Play pause in zoom mode.
■	Stops play.

Play musical slideshow

Play MP3/WMA music files and JPEG photo files simultaneously to create musical slideshow. The MP3/WMA and JPEG files must be stored on the same disc or USB device.

- 1 Play MP3/WMA music.
- 2 Navigate to the photo folder/album and press **OK** to start slideshow play.
 - ↳ Slideshow begins and continues till the end of the photo folder or album.
 - ↳ Audio continues to play till the end of the disc.
 - To stop slideshow play, press **■**.
 - To stop music play, press **■** again.

Play from USB device

This Home Theater System plays/views MP3, WMA, DivX (Ultra) or JPEG files on the following USB devices:

- flash drive
- memory card reader
- HDD (external power source needed)

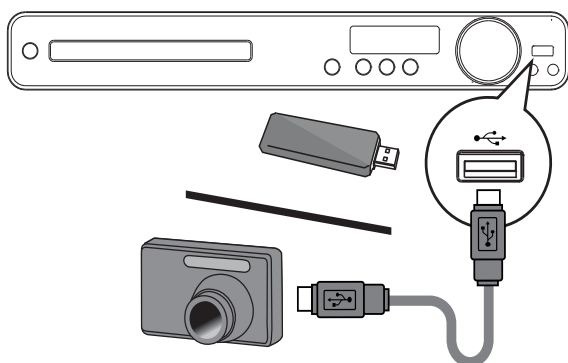

- 1 Connect a USB storage device to the **(USB)** jack.
- 2 Press **USB**.
↳ A contents menu is displayed.
- 3 Select a file to play, then press **▶||**.
↳ Play starts.
- 4 To stop play, press **■** or remove the USB device.

Note

- If the device does not fit into the USB jack, connect it through a USB extension cable.
- If you connect a multiple USB card/device reader, only one card/device can be accessed.
- Digital cameras that need PC software or use PTP protocol are not supported.

Play from radio

Check if the FM antenna has been connected to this Home Theater System. If not, connect the supplied FM antenna to the **FM75 Ω** jack and fix its ends to the wall.

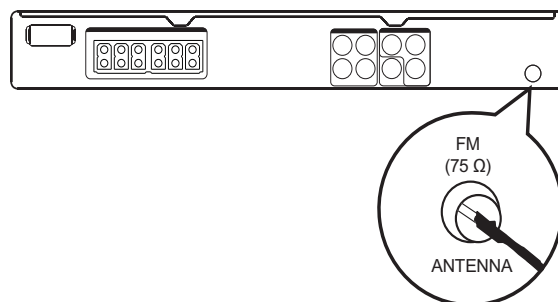

Tip

- For better FM stereo reception, connect an external FM antenna (not supplied).
- Position the antenna as far away as possible from your TV, VCR or other radiation source to prevent interference.

First time tuning

When you access to radio mode for the first time, follow the instructions to install the radio stations.



- 1 Press **RADIO**.
↳ 'AUTO INSTALL ... PRESS PLAY' is displayed.
- 2 Press **▶||**.
↳ All detected radio stations are stored.
↳ Once complete, it tunes to the first preset radio station.
 - To stop auto tuning, press **■**.

Note

- This Home Theater System can store up to a maximum of 40 radio stations.
- If auto installation is not activated or less than 5 radio stations are stored, you will be prompted to install the radio stations again.

Listen to radio

- 1 Press **RADIO**.
- 2 Use the remote control to control the radio.

Button	Action
	Selects a preset radio station.
	Tunes the radio frequency up or down.
	Press and hold this button to erase the current radio station from the preset list. The preset number for other radio stations remain unchanged.

Reinstall all the radio stations





- 1 Press **RADIO**.
- 2 Press and hold **PROGRAM** for more than 5 seconds.
 - ↳ All previously stored radio stations are replaced.



Note

- Check the radio antenna connection if no stereo signal is detected or less than 5 stations are detected during radio installation.

Search and store radio stations individually

- 1 Press **RADIO**.
- 2 Press .
 - ↳ It starts searching until a radio station is detected.
- 3 Repeat step 2 until you tune to the radio station you wish to store.
 - To finetune the radio frequency, press  / .
- 4 Press **PROGRAM**.
 - ↳ The preset station number blinks.
 - ↳ If no action is carried out within 20 seconds after the above step, it exits the preset mode.
- 5 Press  (or the **Numeric buttons**) to select a preset number to store.
- 6 Press **PROGRAM** to confirm.



Change tuning grid

In some countries, the frequency step between adjacent channels in FM band is 50 kHz or 100 kHz.



Note

- This feature only applicable for certain region.
- Change tuning grid erases all preset radio stations.

- 1 Press **RADIO**.
- 2 Press .
- 3 Press and hold  until 'GRID 9' or 'GRID 10' is displayed.
 - ↳ 'GRID 9' for 50 kHz and 'GRID 10' for 100 kHz.

6 Adjust sound

Control the volume

- 1 Press **VOL +/-** to increase or decrease the volume.
 - To mute, press **MUTE**.
 - To restore the volume, press **MUTE** again or press **VOL +**.

Select surround sound

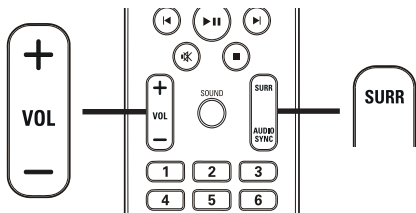

- 1 Press **SURR** repeatedly to select the best surround output that's available on the disc.

Option	Description
5 CH STEREO	Enhances the stereo channel output by duplicating the sound output to the center and rear speakers. Ideal for party music.
MULTI-CHANNEL / DPLII	Multi-channel surround output: Dolby Digital, and Dolby Pro Logic II.
STEREO	Stereo sound



Note

- "Dolby Prologic II" 5-channel mode is the default surround mode whenever you turn on this Home Theatre System or change to other play source.

Select a preset sound

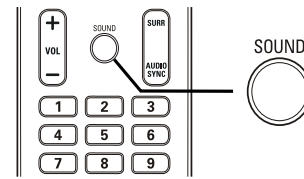

- 1 Press **SOUND** repeatedly to select the sound effect that most suitable for the video or music you play.

Video/Music	Description
ACTION / ROCK	Enhance low and high range for great sounding movie effects and atmosphere. Great for action movies and rock/pop music.
CONCERT/ CLASSIC	Flat and pure sound mode. Ideal for listening to classical music and watching live concert disc.
DRAMA / JAZZ	Clear mid and high range. Recreates the atmosphere of a live club with the artist just in front of you. Good for jazz music and watching dramas.
SPORTS	Moderate mid range and surround effects for clear vocals and the atmosphere of a live sports venue. It is also ideal for video gaming.
NIGHT	Dynamically controlled sound mode suitable for watching movies at night or for nonintrusive background music.

Adjust microphone volume level

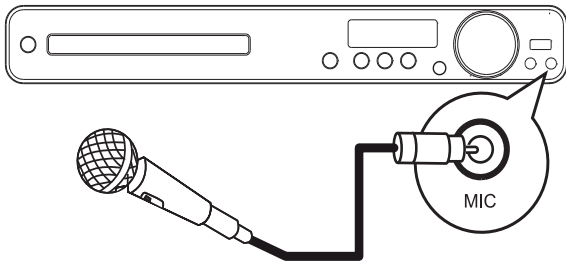

- 1 Connect the supplied microphone to **MIC** jack on this Home Theater System.
- 2 Turn on the microphone output. (see 'Karaoke settings'.)
- 3 Press **MIC (VOL +/-)** to adjust the microphone volume.
 - ↳ 'MICVOL XX' is displayed.
 - Sing or speak through the microphone to find the desired volume level.

Karaoke settings

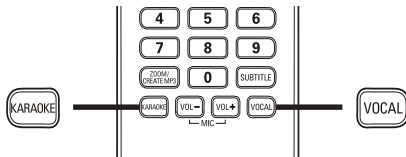

- 1 Turn on the TV to the correct viewing channel for this Home Theater System.
- 2 Press **KARAOKE**.
 - ↳ [**Karaoke Setup Page**] menu is displayed.
- 3 Select an option and change the setting, then press **OK**.
 - To exit the menu, press **KARAOKE**.

[Mic]

Turns on or off microphone output.

- **[On]** – Turns on microphone.
- **[Off]** – Turns off microphone.

[Echo Level]

Press **▲▼** to set the echo level, then press **OK**.

[Key]

Press **▲▼** to set the pitch level that matches your voice, then press **OK**.

[Score]

Selects a karaoke rating score level.

- **[Off]** – No score rating display.
- **[Basic]** – Basic rating.
- **[Intermediate]** – Intermediate rating.
- **[Advance]** – Advance rating.

Turn off vocal (cancel voice)





- 1 Press **VOCAL** repeatedly until 'VOICE CANCEL' is displayed.

Note

- You cannot cancel the voice output from MP3 or WMA audio.

7 Adjust settings

You can customize various kinds of settings as you prefer. Refer to the following instructions to navigate through the setup menus.

Symbol	Options
	[General Setup]
	[Audio Setup]
	[Video Setup]
	[Preferences]

Note

- If the setup option is grayed out, it means the setting cannot be changed at the current state.

General setup

General Setup	
Disc Lock	
Display Dim	
OSD Language	
Screen Saver	
Sleep Timer	
DivX(R) VOD Code	

- 1 Press **SETUP**.
↳ [General Setup] menu is displayed.
- 2 Press **▶**.
- 3 Select an option, then press **OK**.

- 4 Select a setting, then press **OK**.
 - To return to the previous menu, press **← BACK**.
 - To exit the menu, press **SETUP**.

Note

- See the explanations of the above options in the following pages.

[Disc Lock]

Sets play restriction for a specific discs. Before you start, place the disc in the disc compartment (maximum 40 discs can be locked).

- **[Lock]** – Restricts access to the current disc. Once activated, a password is needed to unlock and play the disc.
- **[Unlock]** – Plays all discs.

Tip

- You can set or change the password (see 'Adjust settings' > 'Preferences' > **[Password]**).

[Display Dim]

Changes the brightness level of the display panel on this Home Theater System.

- **[100%]** – Normal brightness.
- **[70%]** – Medium brightness.
- **[40%]** – Dimmest display.

[OSD Language]

Selects the default on-screen menu language.

[Screen Saver]

Turns off or on the screen saver mode. Helps to protect the TV screen from being damaged due to over exposure to a static image for too long.

- **[On]** – Sets the screen saver to appear after 15 minutes of inactivity (for example, in pause or stop mode).
- **[Off]** – Disables screen saver mode.

[Sleep Timer]

Switches to standby automatically after the preset time.

- **[15 mins], [30 mins], [45 mins], [60 mins]** – Selects the count down time before the Home Theater System switches to standby.
- **[Off]** – Disables sleep timer mode.

[DivX(R) VOD Code]

Displays the DivX® registration code.



Tip

- Enter this Home Theater System DivX registration code when you rent or purchase video from www.divx.com/vod. The DivX videos rented or purchased through the DivX® VOD (Video On Demand) service can be played only on the device to which it is registered.

Audio setup

Audio Setup	
Speakers Volume	
Speakers Delay	
Night Mode	

- 1 Press **⏏** **SETUP**.
↳ **[General Setup]** menu is displayed.
- 2 Press **▼** to select **[Audio Setup]**, then press **▶**.
- 3 Select an option, then press **OK**.
- 4 Select a setting, then press **OK**.
 - To return to the previous menu, press **⏪** **BACK**.
 - To exit the menu, press **⏏** **SETUP**.



Note

- See the explanations of the above options in the following pages.

[Speakers Volume]

Sets the volume level of each speaker to get the ideal audio balance.

- 1) To start, press **OK**.
- 2) Select a speaker in the menu, then press **◀▶** to adjust the volume level.
- 3) Press **OK** to confirm and exit.



Note

- The test tone is emitted from the speaker which you adjust.

[Speakers Delay]

Sets the delay time for the center and rear speakers if they are placed closer to the listening position, so that the sound output from all speakers reach the listening position at the same time.

- 1) To start, press **OK**.
- 2) Select a speaker in the menu, then press **◀▶** to set the delay time.
- 3) Press **OK** to confirm and exit.



Note

- Allow 1ms setting for every 1 foot distance between the speaker and the listening position.

[Night Mode]

Makes loud sound level softer and soft sound level louder so that you can watch the DVD movies at a low volume, without disturbing others.

- **[On]** – Enjoys quiet viewing at night.
- **[Off]** – Enjoys surround sound with a full dynamic range.

Note

- Applicable only to Dolby Digital encoded discs.

Video setup

Video Setup	
TV System	
TV Display	
Progressive	
Picture Settings	

- 1 Press **SETUP**.
↳ **[General Setup]** menu is displayed.
- 2 Press **▼** to select **[Video Setup]**, then press **▶**.
- 3 Select an option, then press **OK**.
- 4 Select a setting, then press **OK**.
 - To return to the previous menu, press **← BACK**.
 - To exit the menu, press **SETUP**.

Note

- See the explanations of the above options in the following pages.

[TV System]

Change this setting if the video does not appear correctly. By default, this setting matches the most common setting for TVs in your country.

- **[PAL]** – For PAL-system TV.
- **[NTSC]** – For NTSC-system TV.
- **[Multi]** – For TV that is compatible with both PAL and NTSC.

[TV Display]

Selects one of the following display formats:

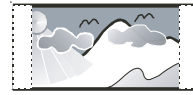

4:3 Pan Scan (PS)



4:3 Letter Box (LB)



16:9 (Wide Screen)

- **[4:3 Pan Scan]** – For 4:3 screen TV: full-height display with the trimmed sides.
- **[4:3 Letter Box]** – For 4:3 screen TV: wide-screen display with black bars on the top and bottom of the screen.
- **[16:9 Wide Screen]** – For wide-screen TV: display ratio 16:9.

[Progressive]

If the TV supports progressive scan output, you can turn on the progressive scan mode to enhance the picture quality. Video connection through Component Video is required.

- **[On]** – Turns on progressive scan mode.
- **[Off]** – Disables progressive scan mode.



Tip

- There is more detailed description available (see 'Get started' > 'Turn on Progressive Scan').

[Picture Settings]

Selects a predefined set of picture color settings or customize the personal setting.

- **[Standard]** – Original color setting.
- **[Bright]** – Vibrant color setting.
- **[Soft]** – Warm color setting.
- **[Personal]** – Customizes the color setting. Set the level of brightness, contrast, sharpness/tint and color saturation, then press **OK**.

Preferences

Note

- Stop disc play before you can access to **[Preferences]**.

Preferences	
Audio	
Subtitle	
Disc Menu	
Parental	
PBC	
MP3/JPEG Display	
Password	
DivX Subtitle	▼

- 1 Press **⏏** **SETUP**.
↳ **[General Setup]** menu is displayed.
- 2 Press **▼** to select **[Preferences]**, then press **▶**.
- 3 Select an option, then press **OK**.
- 4 Select a setting, then press **OK**.
 - To return to the previous menu, press **⏪** **BACK**.
 - To exit the menu, press **⏏** **SETUP**.

Note

- See the explanations of the above options in the following pages.

[Audio]

Selects the default audio language for disc play.

[Subtitle]

Selects the default subtitle language for disc play.

[Disc Menu]

Selects the language for disc menu.

Note

- If the language you have set is not available on the disc, the disc uses its own default language.
- For some discs, the subtitle/audio language can only be changed from the disc menu.
- To select the languages that are not listed in the menu, select **[Others]**. Then check the Language Code list at the back of this user manual and enter the respective 4-digit language code.

[Parental]

Restricts access to discs that are unsuitable for children. These types of discs must be recorded with ratings.

- 1) Press **OK**.
- 2) Select a rating level, then press **OK**.
- 3) Press the **Numeric buttons** to enter the password.

Note

- Rated discs above the level you set in **[Parental]** require a password to be played.
- The ratings are country-dependent. To allow all discs to play, select **'8'**.
- Some discs have ratings printed on them but are not recorded with ratings. This function has no effect on such discs.

Tip

- You can set or change the password (see 'Preferences' > **[Password]**).

[PBC]

Turns off or on the content menu of VCDs/ SVCDs with PBC (playback control) feature.

- **[On]** - Displays index menu when you load a disc for play.
- **[Off]** - Skips the menu and start play from the first title.

[MP3/JPEG Display]

Selects to display the folders or display all the files.

- **[View Folders]** – Displays the folders of MP3/WMA files.
- **[View Files]** – Displays all the files.

[Password]

Sets or changes the password for locked discs and play restricted DVDs.

Change Password	
Old Password	<input type="password"/>
New Password	<input type="password"/>
Confirm Password	<input type="password"/>
OK	

- 1) Press the **Numeric buttons** to enter '136900' or the last set password at **[Old Password]** field.
- 2) Enter the new password at **[New Password]** field.
- 3) Enter the new password again at **[Confirm Password]** field.
- 4) Press **OK** to exit the menu.

Note

- If you forget the password, enter '136900' before you set a new password.

[DivX Subtitle]

Selects a character set that supports the DivX subtitle.

[Standard]	English, Irish, Danish, Estonian, Finnish, French, German, Italian, Portuguese, Luxembourgish, Norwegian (Bokmål and Nynorsk), Spanish, Swedish, Turkish
[Central Europe]	Polish, Czech, Slovak, Albanian, Hungarian, Slovene, Croatian, Serbian (Latin script), Romanian
[Greek]	Greek

Note

- Ensure that the subtitle file has the exact same file name as the movie file. If for example the file name of the movie is 'Movie.avi', then you will need to name the text file 'Movie.sub' or 'Movie.srt'.

[Version Info.]

Displays the software version of this Home Theater System.

Tip

- This information is required when you want to find out if a newest software version is available at the Philips website that you may download and install on this Home Theater System.

[Default]

Resets all the settings of this Home Theater System to factory default, except for **[Disc Lock]**, **[Password]** and **[Parental]** settings.

8 Additional Information

Update software

To check for new updates, compare the current software version of your Home Theater System with the latest software version (if available) at the Philips website.

Preferences	
Disc Menu ▲	
Parental	
PBC	
MP3/JPEG Display	
Password	
DivX Subtitle	
Version Info.	
Default	

- 1 Press **SETUP**.
- 2 Select **[Preferences] > [Version Info.]**, then press **OK**.
- 3 Write down the version number, then press **SETUP** to exit the menu.
- 4 Go to www.philips.com/support to check the latest software version available for this Home Theater System.
- 5 If the latest software version is higher than the software version of this Home Theater System, download it and store onto a CD-R or USB flash drive.
- 6 Insert the CD-R or USB flash drive to this Home Theater System.
- 7 Press **DISC** or **USB**, then follow the instruction on the TV to confirm update operation.
 - ↳ Once software update is complete, this Home Theater System turns off to standby automatically.

Note

- Do not remove the CD-R or USB when software updating is in progress.

- 8 Disconnect the power cord for a few seconds and connect again to reboot the system.

Care

Caution

- Never use solvents such as benzene, thinner, cleaners available commercially, or anti-static sprays intended for discs.

Clean discs

Wipe the disc with a micro fibre cleaning cloth from the centre to the edge in a straight line movement.

Clean main unit screen

Wipe the screen surface with a micro fibre cleaning cloth.

9 Specifications



Note

- Specification and design are subject to change without notice

Playback media

- DVD-Video, DVD+R/+RW, DVD-R/-RW, DVD+R DL, CD-R/CD-RW, Audio CD, Video CD/SVCD, Picture CD, MP3-CD, WMA-CD, DivX-CD, USB flash drive

Amplifier

- Total output power: 300 W RMS (30% THD)
- Frequency response: 180 Hz~18 kHz / ± 3 dB
- Signal-to-noise ratio: > -60 dB (A-weighted)
- Input sensitivity:
 - AUX1: 500 mV
 - AUX2: 500 mV

Disc

- Laser Type: Semiconductor
- Disc diameter: 12cm / 8cm
- Video decoding: MPEG1/ MPEG2 / DivX / DivX Ultra
- Video DAC: 12 bits, 108 MHz
- Signal system: PAL / NTSC
- Video S/N: 56 dB
- Audio DAC: 24 bits / 96 kHz
- Frequency response:
 - 4 Hz - 20 kHz (44.1 kHz)
 - 4 Hz - 22 kHz (48 kHz)
 - 4 Hz - 44 kHz (96 kHz)
- PCM: IEC 60958
- Dolby Digital: IEC 60958, IEC 61937

Radio

- Tuning range: FM 87.5-108 MHz (100 kHz)
- 26 dB quieting sensitivity: FM 22 dBf
- IF rejection ratio: FM 50 dB
- Signal-to-noise ratio: FM 30 dB
- Harmonic distortion: FM 3%
- Frequency response: FM 180 Hz~10 kHz / ± 3 B
- Stereo separation: FM 26 dB (1 kHz)
- Stereo Threshold: FM 23.5 dB

USB

- Compatibility: USB
- Class support: UMS (USB Mass Storage Class)
- File system: FAT12, FAT16, FAT32

Main Unit

- Power supply: 110~240V; ~50-60Hz
- Power consumption: 60 W
- Standby power consumption: < 1 W
- Dimensions (WxHxD): 360 x 55 x 332 (mm)
- Weight: 2.64 kg

Speakers

- System: full range satellite
- Speaker impedance: 8 ohm (center), 4 ohm (Front/Rear)
- Speaker drivers: 3" full range
- Frequency response: 150 Hz - 20 kHz
- Dimensions (WxHxD):
 - Center: 100 x 100 x 75 (mm)
 - Front/Rear: 100 x 100 x 75 (mm)
- Weight:
 - Center: 0.38 kg
 - Front/Rear: 0.38 kg/each

Subwoofer

- Impedance: 8 ohm
- Speaker drivers: 165 mm (6.5") woofer
- Frequency response: 45 Hz ~ 150 Hz
- Dimensions (WxHxD): 122.6 x 309.5 x 369 (mm)
- Weight: 3.54 Kg

Laser specification

- Type: Semiconductor laser GaAlAs (CD)
- Wave length: 645 - 665 nm (DVD), 770 - 800 nm (CD)
- Output power: 6 mW (DVD), 7 mW (VCD/CD)
- Beam divergence: 60 degrees.

10 Troubleshooting



Warning

- Risk of electric shock. Never remove the casing of the Home Theater System.

To keep the warranty valid, never try to repair the system yourself.

If you encounter problems when using the Home Theater System, check the following points before requesting service. If the problem remains unsolved, register your Home Theater System and get support at www.philips.com/welcome.

If you contact Philips, you will be asked for the model and serial number of your Home Theater System. The model number and serial number are on the back or bottom of your Home Theater System. Write the numbers here:

Model No. _____

Serial No. _____

Main unit

The buttons on this Home Theater System do not work.

- Disconnect this Home Theater System from the power outlet for a few minutes, then connect again.

Picture

No picture.

- See TV's manual for correct video input channel selection. Change the TV channel until you see the DVD screen.
- Press **DISC**.
- If you have changed the **[TV Display]** setting, switch back to default mode: 1) Press **▲** to open the disc compartment. 2) Press **◀**. 3) Press **SUBTITLE**.

Sound

No sound.

- Ensure that the audio cables are connected and press the correct input source (for example, **AUDIO SOURCE**, **USB**) to select the device you want to play.
- If this Home Theater System does not support DTS surround sound, ensure that the play source is not from DTS audio stream.

No sound from TV program.

- Connect an audio cable from the AUDIO input on this Home Theater System to the AUDIO output on your TV. Then press **AUDIO SOURCE** repeatedly to select the corresponding audio input source.

No surround sound effect from the speakers.

- Press **SURR** to select a correct surround sound setting.
- If the Home Theater System supports DTS playback, press **AUDIO SYNC** to select other audio track.
- Ensure that the source you are playing is recorded or broadcast in surround sound (Dolby Digital, etc).

Play

DivX video files cannot be played.

- Ensure that the DivX file is encoded according to the 'Home Theater Profile' with the DivX encoder.
- Ensure that the DivX video file is complete.

The aspect ratio of the screen is not aligned with the TV display setting.

- The aspect ratio is fixed on the disc.

DivX subtitle does not display correctly.

- Ensure that the subtitle file name is the same as the movie file name.
- Select the correct character set: 1) Press **⏏ SETUP**. 2) Select **[Preferences]**, then press **▶**. 3) Select **[DivX Subtitle]**, then press **OK**. 4) Select the character set that supports the subtitle.

The contents of the USB flash drive cannot be read.

- The USB flash drive format is not compatible with this Home Theater System.
- Drive is formatted with different file system which is not supported by this unit (e.g. NTFS).
- Maximum size of memory supported is 160GB.

11 Glossary

A

Aspect ratio

Aspect ratio refers to the length to height ratio of TV screens. The ratio of a standard TV is 4:3, while the ratio of a high-definition or wide TV is 16:9. The letter box allows you to enjoy a picture with a wider perspective on a standard 4:3 screen.

D

DivX®

The DivX® codec is a patent-pending, MPEG-4 based video compression technology developed by DivX®, Inc. It can shrink the file size of digital video and still maintain the high visual quality.

Dolby Digital Pro Logic II

An advanced, matrix decoding technology that expands any two channel audio, such as CDs and stereo encoded videocassettes, video games and TV broadcasts to a five channel full bandwidth (range) playback (Left/Center/Right/Left Surround/Right Surround), resulting in a surround sound experience.

J

JPEG

A very common digital still picture format. A still-picture data compression system proposed by the Joint Photographic Expert Group, which features small decrease in image quality in spite of its high compression ratio. Files are recognized by their file extension '.jpg' or '.jpeg.'

M

MP3

A file format with a sound data compression system. MP3 is the abbreviation of Motion Picture Experts Group 1 (or MPEG-1) Audio Layer 3. With the MP3 format, one CD-R or CD-RW can contain about 10 times more data than a regular CD.

MPEG

Motion Picture Experts Group. A collection of compression systems for digital audio and video.

P

PBC

Playback Control. A system where you navigate through a Video CD/Super VCD with on-screen menus that are recorded onto the disc. You can enjoy interactive playback and search.

PCM

Pulse Code Modulation. A digital audio encoding system.

Progressive scan

The progressive scan displays twice the number of frames per second than in an ordinary TV system. It offers higher picture resolution and quality.

W

WMA

Windows Media™ Audio. Refers to an audio compression technology developed by Microsoft Corporation. WMA data can be encoded with Windows Media player version 9 or Windows Media player for Windows XP. Files are recognized by their file extension '.wma.'
