

PHILIPS

Headphones

6000 Series

TAT6908



User manual

Register your product and get support at:
www.philips.com/support

Contents

1	Important safety instructions	2
	Hearing safety	2
	General information	2

2	Your True wireless earpieces	4
	What's in the box	4
	Other devices	4
	Overview of your True wireless earpieces	5

3	Get started	6
	Charge the battery	6
	How to wear	7
	App download	7
	Pair for the first time	7
	Pair with another Bluetooth device	8

4	Use your earpieces	9
	Connect to your Bluetooth device	9
	Control ANC (Active Noise Cancellation)	9
	Enable hearable modes	10
	Power on/off	10
	Manage your calls and music	10
	Voice Assistant	10
	Earpieces LED indicator status	11
	Charging box LED indicator status	11

5	Reset the earpieces	12
---	---------------------	----

6	Technical data	12
---	----------------	----

7	Notice	13
	Declaration of conformity	13
	Disposal of your old product and battery	13
	Remove the integrated battery	13
	Compliance with EMF	14
	Environmental information	14
	Notice of compliance	14

8	Trademarks	16
---	------------	----

9	Frequently asked questions	17
---	----------------------------	----

1 Important safety instructions

Hearing safety



Danger

- To avoid hearing damage, limit the time you use headphones at high volume and set the volume to a safe level. The louder the volume, the shorter the safe listening time is.

Be sure to observe the following guidelines when using your headphones.

- Listen at reasonable volumes for reasonable periods of time.
- Be careful not to adjust the volume continuously upwards as your hearing adapts.
- Do not turn up the volume so high that you can't hear what's around you.
- You should use caution or temporarily discontinue use in potentially hazardous situations.
- Excessive sound pressure from headphones and headphones can cause hearing loss.
- Using headphones with both ears covered while driving is not recommended and may be illegal in some areas.
- For your safety, avoid distractions from music or phone calls while in traffic or other potentially dangerous environments.

General information

To avoid damage or malfunction:

Caution

- Do not expose headphones to excessive heat.
- Do not drop your headphones.
- Headphones shall not be exposed to dripping or splashing. (Refer to the IP rating of specific product)
- Do not allow your headphones to be submerged in water.
- Do not charge your headphones when the connector or socket is wet.
- Do not use any cleaning agents containing alcohol, ammonia, benzene, or abrasives.
- Use a clean, damp cloth to clean your headphones - especially the sound conduits and the microphone holes - regularly and avoid buildup of substances such as sweat or earwax.
- If any sweat or water droplets are left in the sound conduits, air holes or microphone holes, the sound level will temporarily drop or cut out entirely. This is not a malfunction. Use a soft, damp cloth to dry the headphones thoroughly. Alternatively, remove the earbud tips, turn the sound conduits downward and gently tap the headphones about five times on a dry cloth or similar to remove any water collected inside.
- Be sure the headphones are completely dry before charging and using. Avoid using disposable alcohol pads or other substances for cleaning.
- The integrated battery shall not be exposed to excessive heat such as sunshine, fire or the like.
- Danger of explosion if battery is incorrectly replaced. Replace only with the same or equivalent type.
- To achieve the specific IP rating, the charging slot cover must be closed.
- Disposal of a battery into fire or a hot oven, or mechanically crushing or cutting a battery, can result in an explosion.
- Leaving a battery in an extremely high temperature surrounding environment can result in an explosion or the leakage of flammable liquid or gas.
- A battery subjected to extremely low air pressure may result in an explosion or the leakage of flammable liquid or gas.
- Replacement of a battery with an incorrect type risks severely damaging the headphones and the battery (for example, in the case of some lithium battery types).
- If the headset is not used for a long time, the rechargeable battery will begin to lose its charge. To avoid this loss, please fully charge the battery at least once every three months.

- To avoid risk of fire, the equipment is supplied only by external power source which output shall comply with PS1 (with output capacity less than 15W).

Operating and storage temperatures and humidity

- Store in a place where the temperature is between -20°C (-4°F) and 50°C (122°F) with up to 90% relative humidity.
- Operate in a place where the temperature is between 0°C (32°F) and 45°C (113°F) with up to 90% relative humidity.
- Battery life may be shorter in high or low temperature conditions.

2 Your True wireless earpieces

Congratulations on your purchase, and welcome to Philips! To fully benefit from the support that Philips offers, register your product at www.philips.com/support. With these Philips True wireless earpieces you can:

- Enjoy convenient wireless handsfree calls
- Enjoy and control music wirelessly
- Switch between calls and music



Quick start guide



Warranty



Safety leaflet

What's in the box



Philips True wireless earpieces
Philips TAT6908



Eartips x 8



Type-C charging cable (for charging only)

Other devices

A mobile phone or device (e.g. notebook, tablet, Bluetooth adapters, MP3 players etc) which supports Bluetooth and is compatible with the earpieces.

Overview of your Bluetooth wireless headphones

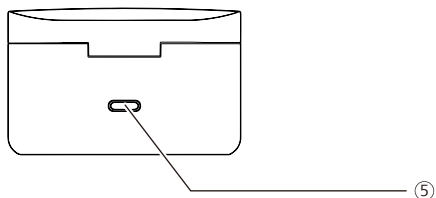
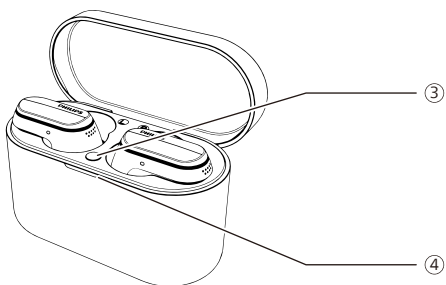
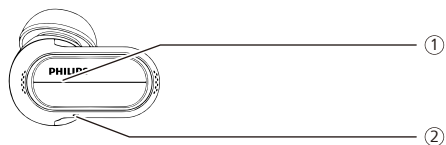

- ① Multi-function button (MFB)
- ② LED indicator (earpieces)
- ③ Bluetooth pair button
- ④ LED indicator (battery state or charging state)
- ⑤ USB-C charging slot

3 Get started

Charge the battery

Note

- Before you use your headphones, place them in the charging box and charge the battery for 2 hours for optimum battery capacity and lifetime.
- Use only the original USB-C charging cable to avoid any damage.
- Finish your call before charging. Connecting the earpieces to charge will power them off.
- If the headset is not used for a long time, the rechargeable battery will begin to lose its charge. To avoid this loss, please fully charge the battery at least once every three months.

Earpieces

Place the earpieces in the charging box.

- The earpieces start charging and the white LED light goes on
- When the earpieces are fully charged, the white light will go off

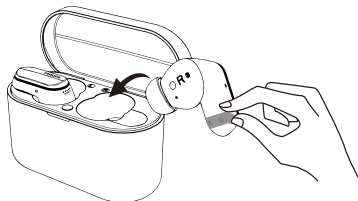

Tip

- Normally, a full charge takes 2 hours (for the earpieces or charging box) by USB cable.

Charging Box

Plug one end of the USB-C cable into the charging box and the other end into the power source.

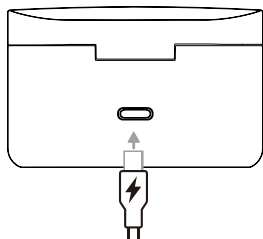

Tip

- The charging box serves as a portable backup battery for charging the earpieces. When the charging box is fully charged, it will fully recharge the earpieces 3 times.

How to wear

Select suitable ear tips for optimum fit

A tight, secure fit will provide the best sound quality and noise-cancellation.

- 1 Test which ear tips provide you with the best sound and wearing comfort.
- 2 4 sizes of silicone ear tips are provided : extra large, large, medium, small.

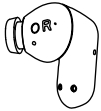
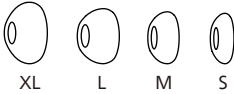

Insert the earpieces

- 1 Check left or right orientation of the earpieces.
- 2 Insert the earpieces into the ears and twist slightly until a secure fit is achieved.

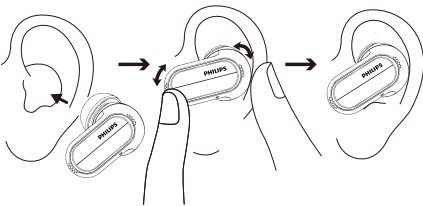

App download

Scan the QR code/press 'Download' button or search 'Philips Headphones' in the Apple App Store or Google Play to download the app.

Get Started



The Philips Headphones App puts you in charge of the music you are listening to. You can customize the sound so that your music and calling experience always best suit your needs.

Pair the earpieces with your Bluetooth device for the first time

- 1 Make sure that the earpieces are fully charged and powered off.
- 2 Open the cover of the charging box, the earpieces will be in pairing mode and ready to connect.
 - ↳ The LEDs on both earpieces flash white and blue alternately.
 - ↳ The earpieces are now in pairing mode and are ready to pair with a Bluetooth device (e.g. a mobile phone).

- 3 Turn on the Bluetooth function of your Bluetooth device.
- 4 Pair the earpieces with your Bluetooth device, refer to the user manual of your Bluetooth device.

Note

- After powering on, if the earpieces cannot find any previously connected Bluetooth device, please put them into pairing mode (press button on box for 3 seconds with both earpieces inside and the cover open).

The following example shows you how to pair the earpieces with your Bluetooth device.

- 1 Turn on the Bluetooth function of your Bluetooth device, select **Philips TAT6908**.
- 2 Enter the earpieces' password "0000" (4 zeros) if prompted. For those devices featuring Bluetooth 3.0 or higher, there is no need to enter a password.



Philips TAT6908

Single earpiece (Mono mode)

Take either right or left earpiece out from charging box for Mono use. The earpiece will power on automatically.

Note

- Take the second earpiece from the charging box and they will pair with each other automatically.

Pair the earpieces with another Bluetooth device

If you want to pair another Bluetooth device with the earpieces, just put them into pairing mode, (press button on box for 3 seconds with both earpieces inside and the cover open), then discover the second device as per normal pairing.

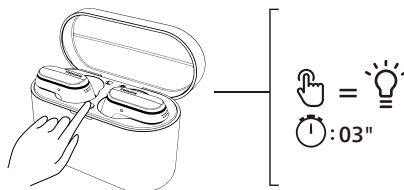

Note

- The earpieces store 4 devices in the memory. If you try to pair more than 4 devices, the earliest paired device is replaced by the new one.

Multi-point connection

Pairing

- Pairing the headphones to 2 devices, e.g. mobile phone and notebook.

Switch between device

- At anytime, you can only listen to music from 1 device. Another device will be for phone call.
- Pause the audio from 1 device and then start play audio from the another device.

Note

- When streaming audio from Device 1, receiving a call from Device 2 will automatically pause Device 1 playback. And the call will be routed automatically to headphones.
- Ending the call will automatically resume playback from device 1.

4 Use your earpieces

Connect the earpieces to your Bluetooth device

- 1 Turn on the Bluetooth function of your Bluetooth device.
- 2 Open the charging box cover.
 - ↳ The blue LED flashes.
 - ↳ The earpieces will search the last connected Bluetooth device and reconnect to it automatically. If the last connected one is not available, the earpieces will enter pairing mode for 3 minutes, if no connection, the earpieces will power off.

Tip

- If you turn on the Bluetooth function of your Bluetooth device after turning on the earpieces, you have to go to the Bluetooth menu of the device and connect the earpieces to the device manually.

Note

- In some Bluetooth devices, connection may not be automatic. In this case, you have to go to the Bluetooth menu of your device and connect the earpieces to the Bluetooth device manually.

Control ANC (Active Noise Cancelation)

Different ANC modes can be toggled via single pressing on the left earpiece.

- ANC function is automatically activated when earpiece is placed in the ear.
- Press the MFB once, it will turn the ANC function off.
- Press the MFB once again, it will change to awareness mode.

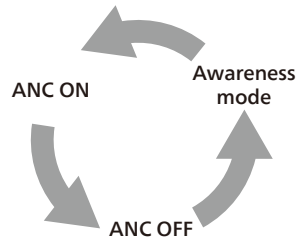

Task	MFB	Operation
ANC ON	Left earpiece	Single press
ANC OFF	Left earpiece	Single press
Awareness mode	Left earpiece	Single press

Enable hearable modes

Different hearable modes can be toggled via long pressing on the left earpiece. My hearing mode will be activated after taking the hearing test in Philips app.

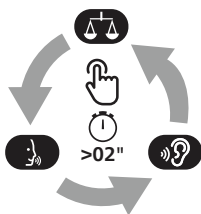

Task	MFB	Operation
Balance mode	Left earpiece	Long press
Vocal mode	Left earpiece	Long press
My hearing mode	Left earpiece	Long press
Exit hearable mode	Left earpiece	Single press

Power on/off

Task	MFB	Operation
Turn the earpieces on		Open the charging box to power on
Turn the earpieces off		Put earpieces back into the charging box and close the charging box to power off

Manage your calls and music

Music control

Task	MFB	Operation
Play or pause music	Right earpiece	Single press
Next track	Right earpiece	Double press
Previous track	Left earpiece	Triple tap
Adjust volume +	Right earpiece	Tap once then long touch
Adjust volume -	Left earpiece	Tap once then long touch

Call control

Task	MFB	Operation
Pick up	Right/Left earpiece	Single press
Hang up call/Reject call	Right/Left earpiece	Double press

Voice Assistant

Task	MFB	Operation
Trigger Voice (Siri/Google) Assistant	Right earpiece	Long press
Stop Voice Assistant	Right earpiece	Single press

Earpieces LED indicator status

Earpieces status	Indicator
The earpieces are connected to a Bluetooth device	White LED blinks once
The earpieces are ready for pairing	The LED flashes blue and white alternately
The earpieces are on but not connected to a Bluetooth device	White LED blinks every second (auto turn off after 3 minutes)
Low battery level (earpieces)	White LED blinks 3x every 5 seconds
Battery is fully charged (charging box)	Refer to case LED

Charging box LED indicator status

When charging	Indicator
Battery low	Amber LED lights up
Relative adequate battery	White LED lights up

In use and cover is open	Indicator
Battery low	White LED slowly blinks for 3 cycles
Relatively adequate battery	Off

5 Reset the earpieces

If you encounter any pairing or connection issue, you can follow the following procedure to reset your earpieces to factory default settings.

- 1 On your Bluetooth device, go to the Bluetooth menu and remove **Philips TAT6908** from the device list.
- 2 Turn off the Bluetooth function of your Bluetooth device.
- 3 Return earpieces to charging box and open the lid.
- 4 Press button on box twice.
- 5 Follow steps in "Use your earpieces- connect the earpieces to your Bluetooth device."
- 6 Pair the earpieces with your Bluetooth device, select **Philips TAT6908**.

If there is no response from the earpieces, you can follow the below step to reset the hardware of your earpieces.

- Return earpieces to charging box and open the lid, press the button on box for more than 10 seconds.

6 Technical data

- Music play time (ANC on) :
7 + 21 hours
- Music play time (ANC off) :
8 + 24 hours
- Standby time: 200 hours
- Charging time: 2 hours
- Lithium-ion battery 63 mAh on each earpiece, Lithium-ion battery 740 mAh on charging box
- Bluetooth version: 5.3
- Compatible Bluetooth profiles:
 - HFP (Hands-Free Profile)
 - A2DP (Advanced Audio Distribution Profile)
 - AVRCP (Audio Video Remote Control Profile)
- Supported audio codecs: AAC, SBC
- Frequency range: 2.402-2.480 GHz
- Transmitter power: < 10 dBm
- Operating range: Up to 10 meters (33 feet)
- Auto power off
- USB-C port for charging
- Low battery warning: available



Note

- Specifications are subject to change without notice.

7 Notice

Declaration of conformity

Hereby, MMD Hong Kong Holding Limited declares that the product is in compliance with the essential requirements and other relevant provisions of RED Directive 2014/53/EU and UK Radio Equipment Regulations SI 2017 No 1206. You can find the Declaration of Conformity on www.philips.com/support.

Disposal of your old product and battery



Your product is designed and manufactured with high quality materials and components which can be recycled and reused.



This symbol on a product means that the product is covered by European Directive 2012/19/EU.



This symbol means that the product contains a built-in rechargeable battery covered by European Directive 2013/56/EU which cannot be disposed of with normal household waste. We strongly advise you to take your product to an official collection point or a Philips service centre to have a professional remove the rechargeable battery. Inform yourself about the local separate collection system for electrical and electronic products and rechargeable batteries. Follow local rules and never dispose of the product and rechargeable batteries with normal household waste. Correct disposal of old products and rechargeable batteries helps prevent negative consequences for the environment and human health.

Remove the integrated battery

If there is no collection/recycling system for electronic products in your country, you can protect the environment by removing and recycling the battery before disposing of the earpieces.

- Make sure the earpieces are disconnected from the charging box before removing the battery.

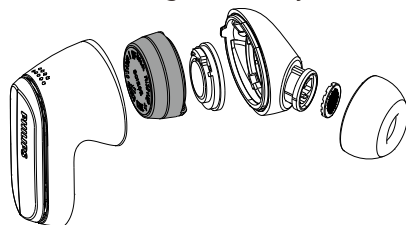

- Make sure the charging box is disconnected from the USB charging cable before removing the battery.

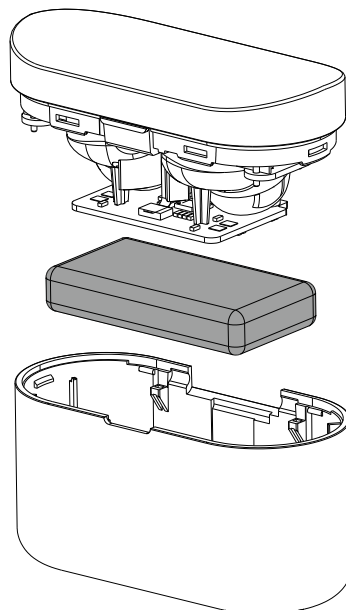

Compliance with EMF

This product complies with all applicable standards and regulations regarding exposure to electromagnetic fields.

Environmental information

All unnecessary packaging has been omitted. We have tried to make the packaging easy to separate into three materials: cardboard (box), polystyrene foam (buffer) and polyethylene (bags, protective foam sheet.)

Your system consists of materials which can be recycled and reused if disassembled by a specialized company. Please observe the local regulations regarding the disposal of packaging materials, exhausted batteries and old equipment.

Notice of compliance

The device complies with the FCC rules, Part 15. Operation is subject to the following two conditions:

- 1. This device may not cause harmful interference, and**
- 2. This device must accept any interference received, including interference that may cause undesired operation.**

FCC rules

This equipment has been tested and found to comply with the limits for a Class B digital device, pursuant to part 15 of the FCC Rules. These limits are designed to provide reasonable protection against harmful interference in a residential installation. This equipment generates, uses and can radiate radio frequency energy and,

if not installed and used in accordance with the instruction manual, may cause harmful interference to radio communications.

However, there is no guarantee that interference will not occur in a particular installation. If this equipment does cause harmful interference to radio or television reception, which can be determined by turning the equipment off and on, the user is encouraged to try to correct the interference by one or more of the following measures:

- Reorient or relocate the receiving antenna
- Increase the separation between equipment and receiver
- Connect the equipment into an outlet on a circuit different from that to which the receiver is connected
- Consult the dealer or an experienced radio/TV technician for help

FCC Radiation Exposure Statement:

This equipment complies with FCC radiation exposure limits set forth for an uncontrolled environment.

This transmitter must not be co-located or operated in conjunction with any other antenna or transmitter.

Caution: The user is cautioned that changes or modifications not expressly approved by the party responsible for compliance could void the user's authority to operate the equipment.

Canada:

This device contains licence-exempt transmitter(s)/receiver(s) that comply with Innovation, Science and Economic Development Canada's license-exempt RSS(s). Operation is subject to the following two conditions: (1) This device may not cause interference. (2) This device must accept any interference, including interference that may cause undesired operation of the device.

L'émetteur/récepteur exempt de licence contenu dans le présent appareil est conforme aux CNR d'Innovation, Sciences et Développement économique Canada applicables aux appareils radio exempts de licence.

L'exploitation est autorisée aux deux conditions suivantes : (1) L'appareil ne doit pas produire de brouillage; (2) L'appareil doit accepter tout brouillage radioélectrique subi, même si le brouillage est susceptible d'en compromettre le fonctionnement.

CAN ICES-003(B)/NMB-003(B)

This equipment complies with Canada radiation exposure limits set forth for uncontrolled environments.

This transmitter must not be co-located or operated in conjunction with any other antenna or transmitter.

8 Trademarks

Bluetooth

The Bluetooth® word mark and logos are registered trademarks owned by Bluetooth SIG, Inc. and any use of such marks by MMD Hong Kong Holding Limited is under license. Other trademarks and trade names are those of their respective owners.

Siri

Siri is a trademark of Apple Inc., registered in the U.S. and other countries.

Google

Google and Google Play are trademarks of Google LLC.

9 Frequently asked questions

My Bluetooth earpieces do not turn on.

The battery level is low. Charge the earpieces.

I cannot pair my Bluetooth earpieces with my Bluetooth device.

The Bluetooth is disabled. Enable the Bluetooth feature on your Bluetooth device and turn on the Bluetooth device before you turn on the earpieces.

Pairing does not work.

- Put both earpieces into charging box.
- Make sure you have disabled the Bluetooth function of any previously connected Bluetooth devices.
- On your Bluetooth device, delete "Philips TAT6908" from the Bluetooth list.
- Pair your earpieces (see 'Pair the earpieces with your Bluetooth device for the first time' on page 7).

The Bluetooth device cannot find the earpieces.

- The earpieces may be connected to a previously paired device. Turn off the connected device or move it out of range.
- Pairing may have been reset or the earpieces have been previously paired with another device. Pair the earpieces with the Bluetooth device again as described in the user manual. (see 'Pair the earpieces with your Bluetooth device for the first time' on page 7).

My Bluetooth earpieces are connected to a Bluetooth stereo-enabled mobile phone, but music only plays on the mobile phone speaker.

Refer to the user manual of your mobile phone. Select to listen to music through the earpieces.

The audio quality is poor and a crackling noise can be heard.

- The Bluetooth device is out of range. Reduce the distance between your earpieces and Bluetooth device, or remove obstacles between them.
- Charge your earpieces.

The audio quality is poor when streaming from a mobile phone is very slow or streaming does not work at all.

Make sure your mobile phone not only supports (mono) HFP but also supports A2DP and is BT4.0x (or higher) compatible (see 'Technical data' on page 12).

Clean your headphones regularly.

- Use a clean, damp cloth to clean your headphones - especially the sound conduits and the microphone holes - regularly and avoid buildup of substances such as sweat or earwax.
- If any sweat or water droplets are left in the sound conduits, air holes or microphone holes, the sound level will temporarily drop or cut out entirely. This is not a malfunction. Use a soft, damp cloth to dry the headphones thoroughly. Alternatively, remove the earbud tips, turn the sound conduits downward and gently tap the headphones about five times on a dry cloth or similar to remove any water collected inside.
- Be sure the headphones are completely dry before charging and using. Avoid using disposable alcohol pads or other substances for cleaning.

Charge your headphones regularly.

If the headset is not used for a long time, the rechargeable battery will begin to lose its charge. To avoid this loss, please fully charge the battery at least once every three months.



2023 © MMD Hong Kong Holding Limited. All rights reserved. Specifications are subject to change without notice. Philips and the Philips Shield Emblem are registered trademarks of Koninklijke Philips N.V. and are used under license. This product has been manufactured by and is sold under the responsibility of MMD Hong Kong Holding Limited or one of its affiliates, and MMD Hong Kong Holding Limited is the warrantor in relation to this product. All other company and product names may be trademarks of its respective companies with which they are associated.

