

# 3 Enjoy

Register your product and get support at  
[www.philips.com/welcome](http://www.philips.com/welcome)

HTS3365

## Start disc playback

- 1 Press **▲** to open the disc tray.

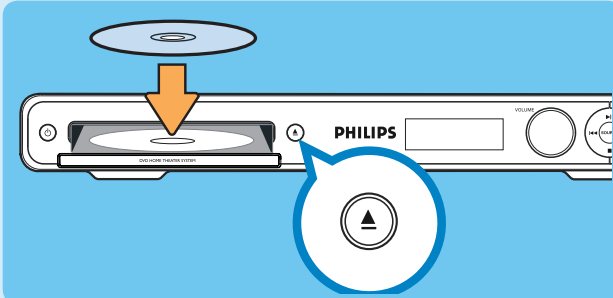

- 2 Place a disc with the disc label facing up.
- 3 Press **▲** to close the disc tray.
- 4 Playback starts automatically.
- 5 If the disc menu appears on the TV, use **◀▶▲▼** keys or the numeric keypad to select an option in the menu and press **OK** to start playback.
- 6 Press **■** to stop playback.

**Note** When you press **▶||** button, playback resumes from where it last stopped. To start playback from the beginning, you have to press **◀**.

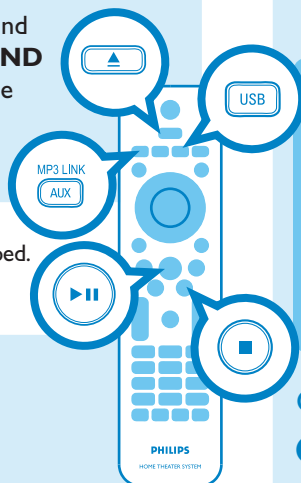

## Playback other supported devices

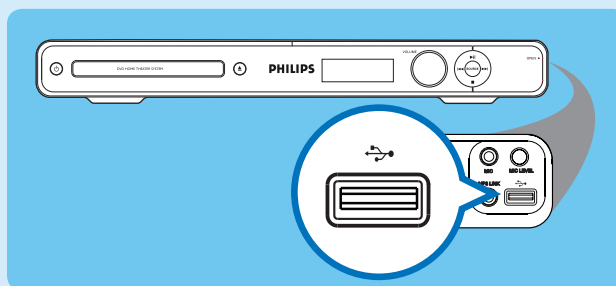

### USB device

- 1 Insert your USB device to the USB socket.
- 2 Press **USB** to switch to 'USB' mode.
- 3 Press **▶||** to start playback.
- 4 To stop playback, press **DISC** to switch to 'DISC' mode. You can unplug your USB device now.

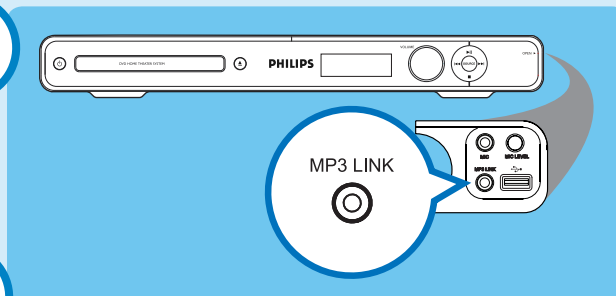

### Other portable audio player

- 1 Use a 3.5mm stereo audio cable (not supplied) to connect the headphone output socket on your portable audio player to MP3 LINK socket.
- 2 Press **PLAY** on your portable audio player.
- 3 Press **AUX (MP3 LINK)** repeatedly until 'MP3 LINK' is displayed, to listen to the playback.



- 1 Connect
- 2 Set up
- 3 Enjoy

# Quick Start Guide

## What's in the box?

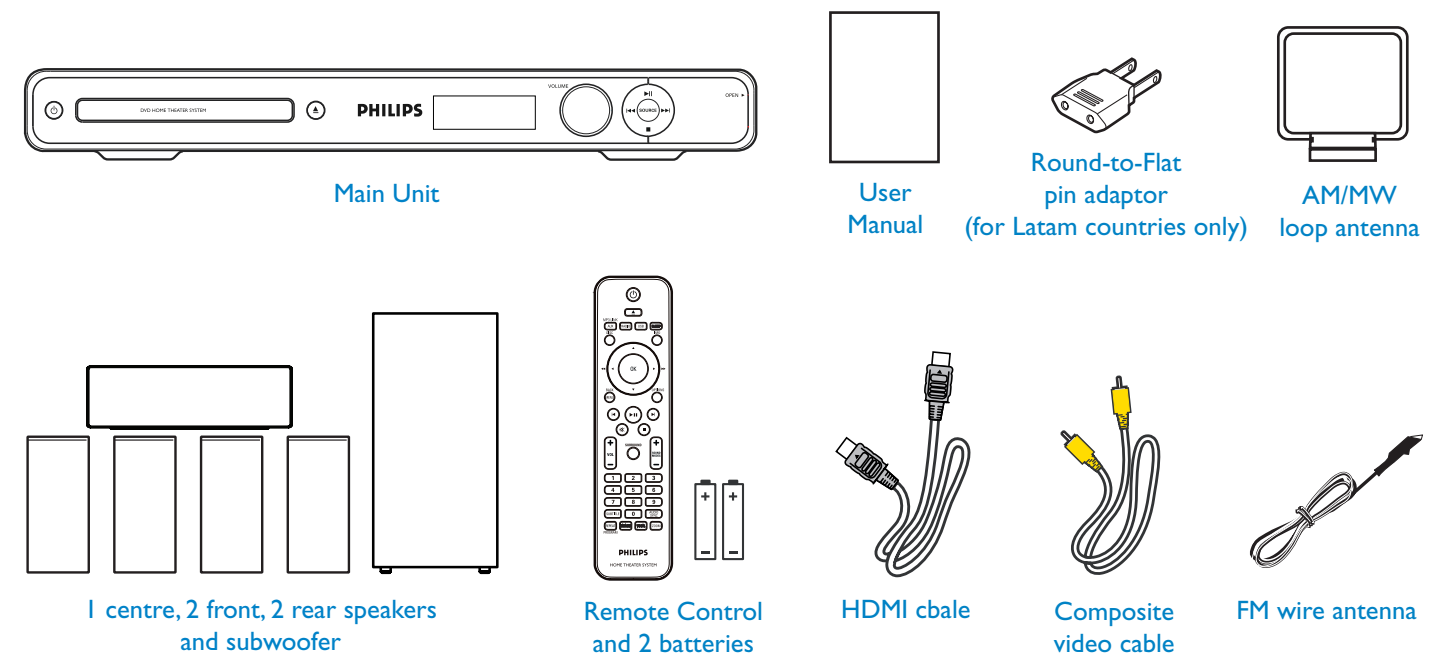

## Need help?

User Manual  
 See the user manual that came with your Philips DVD Home Theatre System.

Be responsible  
 Respect copyrights

**PHILIPS** 2008 © Koninklijke Philips N.V.  
 All rights reserved.  
[www.philips.com](http://www.philips.com)

**PHILIPS**

# 1 Connect

## A Placement

Proper speakers system placement is important to ensure optimum sound performance.

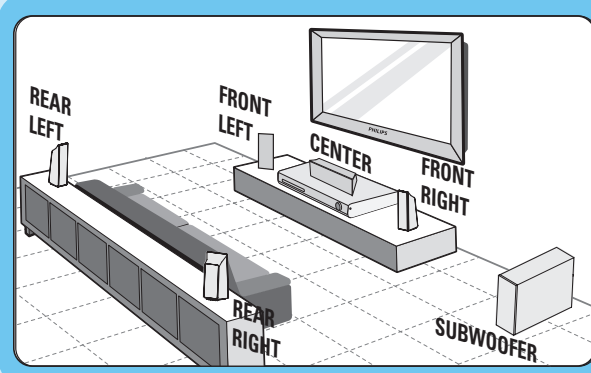

- 1 Place the centre speaker above or close to the TV.
- 2 Place the subwoofer on the floor, at least one metre away from the TV.
- 3 Place the front speakers at equal distances from the TV.
- 4 Place the rear speakers at the back or beside the listening position.

## B Connect the main unit to TV

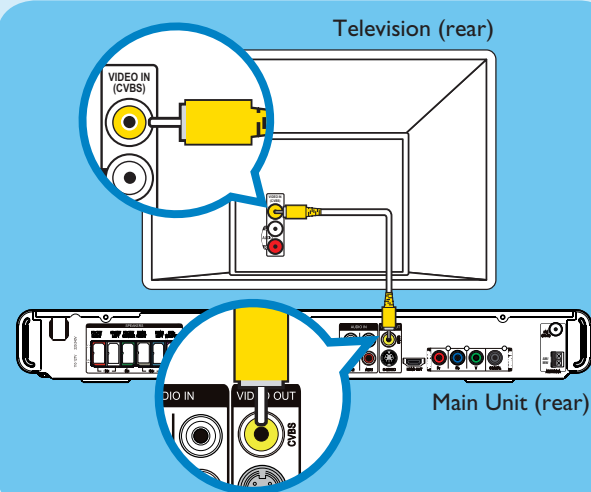

- Use the supplied composite video cable to connect the CVBS socket on the main unit to the VIDEO IN socket on your TV.

**Note** If your TV supports HDMI, connect this unit to your TV using HDMI connection for better picture quality. See the accompanying user manual for more information.

## C Connect the speakers and subwoofer

Connect the various coloured plugs from the speakers and subwoofer to the same coloured sockets at the rear of the main unit.

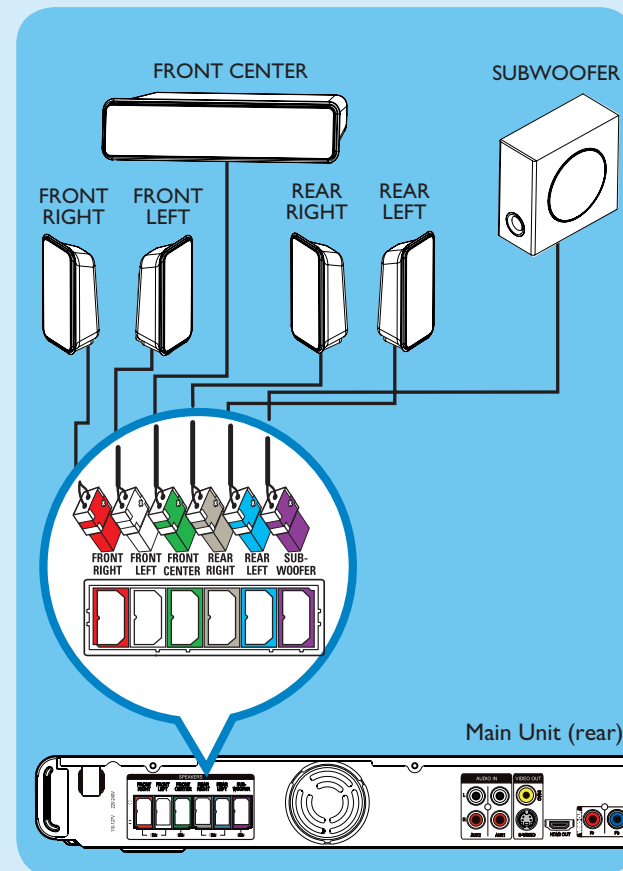

## D Connect the radio antennas and power cable

Keep the antennas away from the electronic devices to prevent unwanted interference.

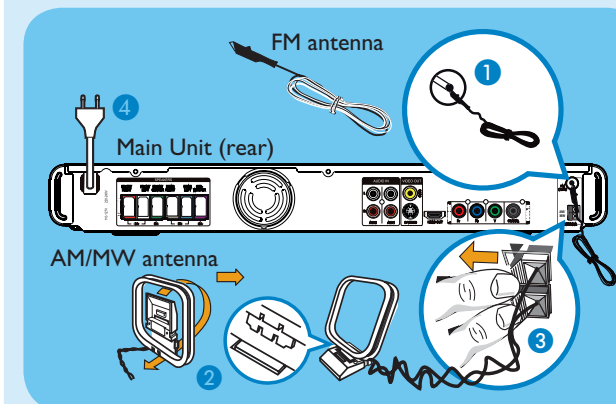

- 1 Connect the FM antenna (supplied) to the inner pin of the FM 75 Ω socket. (For some models, it has been connected in the factory.) Extend the wire for optimum reception.
- 2 Unfold the AM/MW loop antenna (supplied) and fix the claw into the slot.
- 3 Press on the AM/MW tabs and insert the wires into the sockets.
- 4 Connect the power cable from the main unit to the AC power outlet.

## E Connect audio output from TV (optional)

To hear the TV audio through this unit, use a red and white audio cables (not supplied) to connect the AUDIO IN-AUX sockets on the main unit to the AUDIO OUT sockets on your TV.

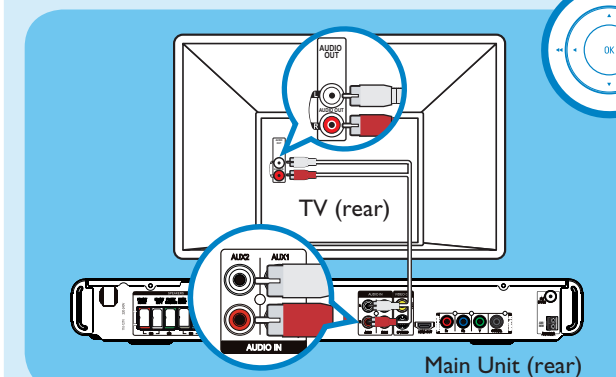

**Note** When watching the TV programs, you can press **AUX (MP3 LINK)** repeatedly on the remote control until 'AUX 1' or 'AUX 2' is displayed to get the sound output from the speakers.

# 2 Set up

## A Finding the viewing channel

- 1 Press **Standby-On** on the main unit to turn it on.
- 2 Turn on the TV. Use the TV's remote control to select the correct viewing channel.

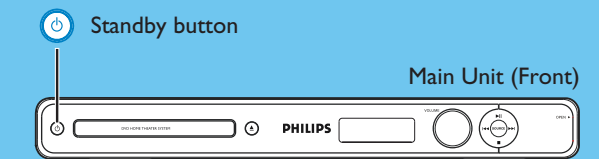

**Note** To search for the correct viewing channel, press the Channel Down button on the TV's remote control repeatedly (or AV, SELECT, **CH** button) until you see the Video In channel.

## B Select the display language on the screen

- 1 Press **OPTIONS**. The { General Setup } appears.
- 2 Press **▶**.



- 3 Use **▼▲** keys to select { OSD Language } and press **▶**.
- 4 Use **▼▲** keys to select a language option in the menu and press **OK** to confirm.
- 5 Press **OPTIONS** to exit.

**Note** The language set here is only for the menus that are shown on the TV while operating this Home Theatre system, not for the DVD disc menu.

There are various setup options (Audio Setup, Video Setup, Preferences) available on this Home Theatre System. Refer to the user manual for more information.