

DVDVIDEO DIGITAL SURROUND SYSTEM

MX6050D



**Need help? Call us!**

*Philips representatives are ready to help you with any questions about your new product. We can guide you through Connections, First-time Setup, or any of the Features. We want you to start enjoying your new product right away!*

**CALL US BEFORE YOU CONSIDER  
RETURNING THE PRODUCT!**

**1-800-531-0039**

or

**Visit us on the web at [www.philips.com](http://www.philips.com)**

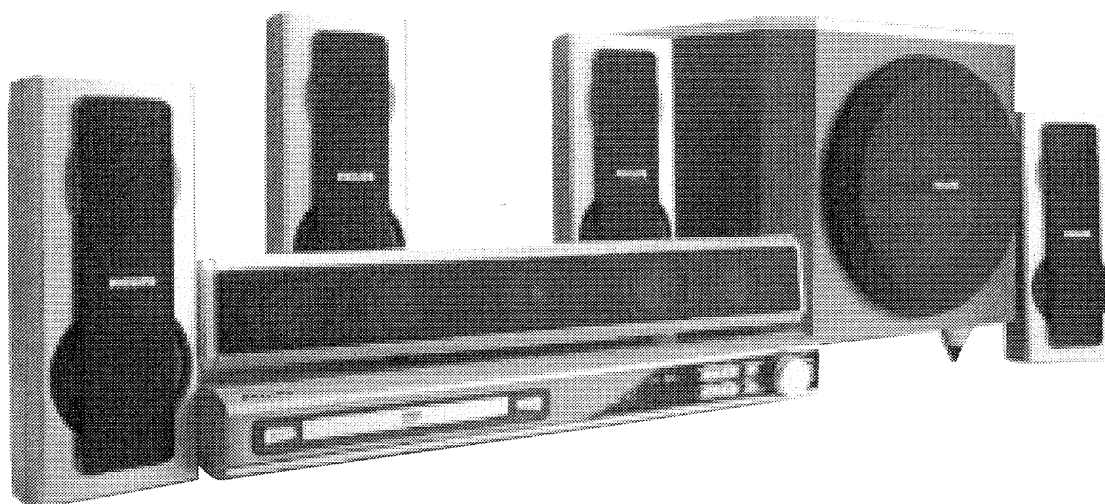

996500023657

**PHILIPS**

**Return your Warranty Registration card today to ensure you receive all the benefits you're entitled to.**

- Once your Philips purchase is registered, you're eligible to receive all the privileges of owning a Philips product.
- So complete and return the Warranty Registration Card enclosed with your purchase at once, and take advantage of these important benefits.

<b>Warranty Verification</b>	<b>Owner Confirmation</b>	<b>Model Registration</b>
Registering your product within 10 days confirms your right to maximum protection under the terms and conditions of your Philips warranty.	Your completed Warranty Registration Card serves as verification of ownership in the event of product theft or loss.	Returning your Warranty Registration Card right away guarantees you'll receive all the information and special offers which you qualify for as the owner of your model.

Know these *safety* symbols



 This "bolt of lightning" indicates uninsulated material within your unit may cause an electrical shock. For the safety of everyone in your household, please do not remove product covering.

 The "exclamation point" calls attention to features for which you should read the enclosed literature closely to prevent operating and maintenance problems.

**For Customer Use**

Enter below the Serial No. which is located on the rear of the cabinet. Retain this information for future reference.

Model No. \_\_\_\_\_

Serial No. \_\_\_\_\_

**WARNING:** TO PREVENT FIRE OR SHOCK HAZARD, DO NOT EXPOSE THIS EQUIPMENT TO RAIN OR MOISTURE.

**CAUTION:** To prevent electric shock, match wide blade of plug to wide slot, and fully insert.

# 1. *Journal of the American Medical Association* 2. *Journal of the American Dental Association*

3. *Journal of the American Veterinary Association*  
4. *Journal of the American Pharmacological Association*

5. *Journal of the American Chemical Society*  
6. *Journal of the American Physical Society*  
7. *Journal of the American Mathematical Society*  
8. *Journal of the American Historical Association*

9. *Journal of the American Statistical Association*  
10. *Journal of the American Economic Association*



11. *Journal of the American Geographical Society*  
12. *Journal of the American Philosophical Society*

13. *Journal of the American Biological Association*  
14. *Journal of the American Psychological Association*

15. *Journal of the American Political Science Association*  
16. *Journal of the American Sociological Association*

17. *Journal of the American Anthropological Association*  
18. *Journal of the American Musicological Association*

19. *Journal of the American Library Association*  
20. *Journal of the American Library Association*



# PHILIPS



***Congratulations on your purchase,  
and welcome to the "family!"***

**Dear Philips product owner:**

Thank you for your confidence in Philips. You've selected one of the best-built, best-backed products available today. And we'll do everything in our power to keep you happy with your purchase for many years to come.

As a member of the Philips "family," you're entitled to protection by one of the most comprehensive warranties and outstanding service networks in the industry.

What's more, your purchase guarantees you'll receive all the information and special offers for which you qualify, plus easy access to accessories from our convenient home shopping network.

And most importantly you can count on our uncompromising commitment to your total satisfaction.

All of this is our way of saying welcome – and thanks for investing in a Philips product.

Sincerely,

Lawrence J. Blanford  
President and Chief Executive Officer

**P.S. Remember, to get the most from your Philips product, you must return your Warranty Registration Card within 10 days. So please mail it to us right now!**

# PHILIPS



In the year 1950, the  
 of the company was  
 by the board of directors  
 to be a new and better  
 organization, one that would  
 be able to meet the needs  
 of the future. This was  
 done by the creation of  
 a new department, the  
 of which was to be  
 the responsibility of  
 the new department head.  
 This was done in order  
 to ensure that the  
 company was able to  
 meet the needs of the  
 future.

The new department  
 was created in the  
 year 1950.

The new department  
 was created in the  
 year 1950.

The new department  
 was created in the  
 year 1950.

# IMPORTANT SAFETY INSTRUCTIONS

1. Read these instructions.
2. Keep these instructions.
3. Heed all warnings.
4. Follow all instructions.
5. Do not use this apparatus near water.

6. Clean only with dry cloth.
7. Do not block any ventilation openings. Install in accordance with the manufacturer's instructions.

8. Do not install near any heat sources such as radiators, heat registers, stoves, or other apparatus (including amplifiers) that produce heat.

9. Do not defeat the safety purpose of the polarized or grounding-type plug.

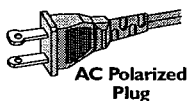

A polarized plug has two blades with one wider than the other. A grounding type plug has two blades and a third grounding prong. The wide blade or the third prong are provided for your safety. If the provided plug does not fit into your outlet, consult an electrician for replacement of the obsolete outlet.

10. Protect the power cord from being walked on or pinched, particularly at plugs, convenience receptacles, and the point where they exit from the apparatus.

11. Only use attachments/accessories specified by the manufacturer.

12.  Use only with the cart, stand, tripod, bracket, or table specified by the manufacturer or sold with the apparatus. When a cart is used, use caution when moving the cart/apparatus combination to avoid injury from tip-over.

13. Unplug this apparatus during lightning storms or when unused for long periods of time.

14. Refer all servicing to qualified service personnel. Servicing is required when the apparatus has been damaged in any way, such as power-supply cord or plug is damaged, liquid has been spilled or objects have fallen into the apparatus, the apparatus has been exposed to rain or moisture, does not operate normally, or has been dropped.

15. **Battery usage CAUTION** – To prevent battery leakage which may result in bodily injury, property damage, or damage to the unit:

- Install **all** batteries correctly, + and - as marked on the unit.
- Do not mix batteries (**old** and **new** or **carbon** and **alkaline**, etc.).
- Remove batteries when the unit is not used for a long time.

16. Apparatus shall not be exposed to dripping or splashing.

17. Do not place any sources of danger on the apparatus (e.g. liquid filled objects, lighted candles).

18. This product may contain lead and mercury. Disposal of these material may be regulated due to environment considerations.

**For disposal or recycling information, please contact your local authorities or the Electronic Industries Alliance : [www.eiae.org](http://www.eiae.org).**

EL 6475-E004: 03/12

[illegible text]

[illegible text]

## Canada

### English:

This digital apparatus does not exceed the Class B limits for radio noise emissions from digital apparatus as set out in the Radio Interference Regulations of the Canadian Department of Communications.

This warning label is located on the rear side and inside this laser product.

**CAUTION:** INVISIBLE LASER RADIATION WHEN OPEN. DO NOT STARE INTO BEAM.  
**DANGER:** INVISIBLE LASER RADIATION WHEN OPEN. AVOID DIRECT EXPOSURE TO BEAM.  
**VARO!** AVATTAESSA JA SUOJALUKITUS OHITETTAESSA OLET ALTTIJINÄNÄKYMÄTTÖMÄÄLLÄ LASERSÄTEILYLLE. ÄLÄ KATSO SÄTEESEEN.  
**WARNING!** ÖSYNLIIG LASERSTRÅLNING NÄR DENNA DEL ÄR ÖPPNAD. ÖCH SPÄRREN ÄR URKOPPLAD. BETRÄKTA EJ STRÅLEN.

or

**DANGER** - Invisible laser radiation when open. AVOID DIRECT EXPOSURE TO BEAM.

'CONSUMERS SHOULD NOTE THAT NOT ALL HIGH DEFINITION TELEVISION SETS ARE FULLY COMPATIBLE WITH THIS PRODUCT AND MAY CAUSE ARTIFACTS TO BE DISPLAYED IN THE PICTURE. IN CASE OF 525 OR 625 PROGRESSIVE SCAN PICTURE PROBLEMS, IT IS RECOMMENDED THAT THE USER SWITCH THE CONNECTION TO THE 'STANDARD DEFINITION' OUTPUT. IF THERE ARE QUESTIONS REGARDING OUR TV SET COMPATIBILITY WITH THIS MODEL 525p AND 625p DVD PLAYER, PLEASE CONTACT OUR CUSTOMER SERVICE CENTER.'

### Laser

Type	Semiconductor laser GaAlAs
Wave length	650nm
Output Power	7mW
Beam divergence	60 degree

### Class II equipment symbol



This symbol indicates that the unit has a double insulation system

## CAUTION

*Use of controls or adjustments or performance of procedures other than herein may result in hazardous radiation exposure or other unsafe operation.*

## ATENCIÓN

*El uso de mando o ajustes o la ejecución de métodos que no sean los aquí descritos puede ocasionar peligro de exposición a radiación.*

## IMPORTANT NOTE

*Due to the numerous versions of new CD-Audio copy protection or enhanced CD-Audio protection recently available on certain discs, Philips is unable to guarantee that this DVD system is fully compatible with such new discs. Should you have difficulty playing such CD-Audio discs, kindly refer them to your CD-Audio disc retailer.*

'CONSUMERS SHOULD NOTE THAT NOT ALL HIGH DEFINITION TELEVISION SETS ARE FULLY COMPATIBLE WITH THIS PRODUCT AND MAY CAUSE ARTIFACTS TO BE DISPLAYED IN THE PICTURE. IN CASE OF 525 OR 625 PROGRESSIVE SCAN PICTURE PROBLEMS, IT IS RECOMMENDED THAT THE USER SWITCH THE CONNECTION TO THE 'STANDARD DEFINITION' OUTPUT. IF THERE ARE QUESTIONS REGARDING OUR TV SET COMPATIBILITY WITH THIS MODEL 525p AND 625p DVD PLAYER, PLEASE CONTACT OUR CUSTOMER SERVICE CENTER.'



1. **Introduction**  
The purpose of this study is to investigate the effects of a new educational program on student performance. The program is designed to improve learning outcomes through a combination of traditional classroom instruction and modern technology.

2. **Methodology**  
The study employed a quasi-experimental design. Participants were divided into two groups: a control group and an experimental group. The experimental group received the new educational program, while the control group received traditional instruction.

3. **Results**  
The results of the study indicate that the experimental group showed significantly higher scores on the final exam compared to the control group. This suggests that the new educational program is effective in improving student performance.

4. **Conclusion**  
Based on the findings, it is concluded that the new educational program is a promising approach for enhancing learning outcomes. Further research is needed to explore the long-term effects of the program.

5. **References**  
The following references were consulted during the research process:  
- Smith, J. (2018). *Effective Teaching Strategies*. New York: Education Press.  
- Doe, A. (2019). *Modern Educational Technology*. London: TechEd.

6. **Appendix**  
Appendix A: Sample questions from the final exam.  
Appendix B: Detailed description of the new educational program.

7. **Notes**  
The data for this study were collected from a sample of 100 students. The results are representative of the population of students in the study. The study was conducted over a period of six months.

8. **Disclaimer**  
The findings of this study are preliminary and should not be used to make definitive conclusions. The study was funded by the Department of Education.

9. **Contact Information**  
For more information, please contact the author at [email address].

*This product incorporates copyright protection technology that is protected by method claims of certain U.S. patents and other intellectual property rights owned by Macrovision Corporation and other rights owners. Use of this copyright protection technology must be authorized by Macrovision Corporation, and is intended for home and other limited viewing uses only unless otherwise authorized by Macrovision Corporation. Reverse engineering or disassembly is prohibited.*

*Manufactured under license from Dolby Laboratories. "Dolby", "Pro-Logic" and the double-D symbol are trademarks of Dolby Laboratories. C*

**Environmental information**

All unnecessary packaging has been omitted. We have tried to make the packaging easy to separate into three materials: cardboard (box), polystyrene foam (buffer) and polyethylene (bags, protective foam sheet).

Your system consists of materials which can be recycled and reused if disassembled by a specialized company. Please observe the local regulations regarding the disposal of packaging materials, exhausted batteries and old equipment.

***This system complies with the FCC rules, Part 15 and with 21 CFR 1040.10.***

***Operation is subject to the following two conditions:***

- This device may not cause harmful interference, and***
- This device must accept any interference received, including interference that may cause undesired operation.***

1. The first part of the document discusses the importance of maintaining accurate records of all transactions. It emphasizes that proper record-keeping is essential for ensuring the integrity and reliability of financial data. This section also outlines the various methods and tools used to collect and analyze data, highlighting the need for consistency and transparency in the reporting process.

2. The second part of the document focuses on the challenges and risks associated with data management. It identifies common pitfalls such as data loss, corruption, and unauthorized access, and provides strategies to mitigate these risks. This section also discusses the importance of regular backups and the use of secure storage solutions to protect sensitive information.

3. The third part of the document addresses the legal and ethical considerations surrounding data collection and use. It discusses the requirements for obtaining informed consent from individuals and the importance of adhering to data protection regulations. This section also explores the ethical implications of data analysis and the need for transparency in the reporting process.

4. The final part of the document provides a summary of the key findings and conclusions. It reiterates the importance of maintaining accurate records and the need for robust data management practices. This section also offers recommendations for future research and the development of more effective data collection and analysis methods.

# Quick Use Guide

MX6050D

# PHILIPS

12nc: 8239 300 30561  
Printed In China

## First connect ...

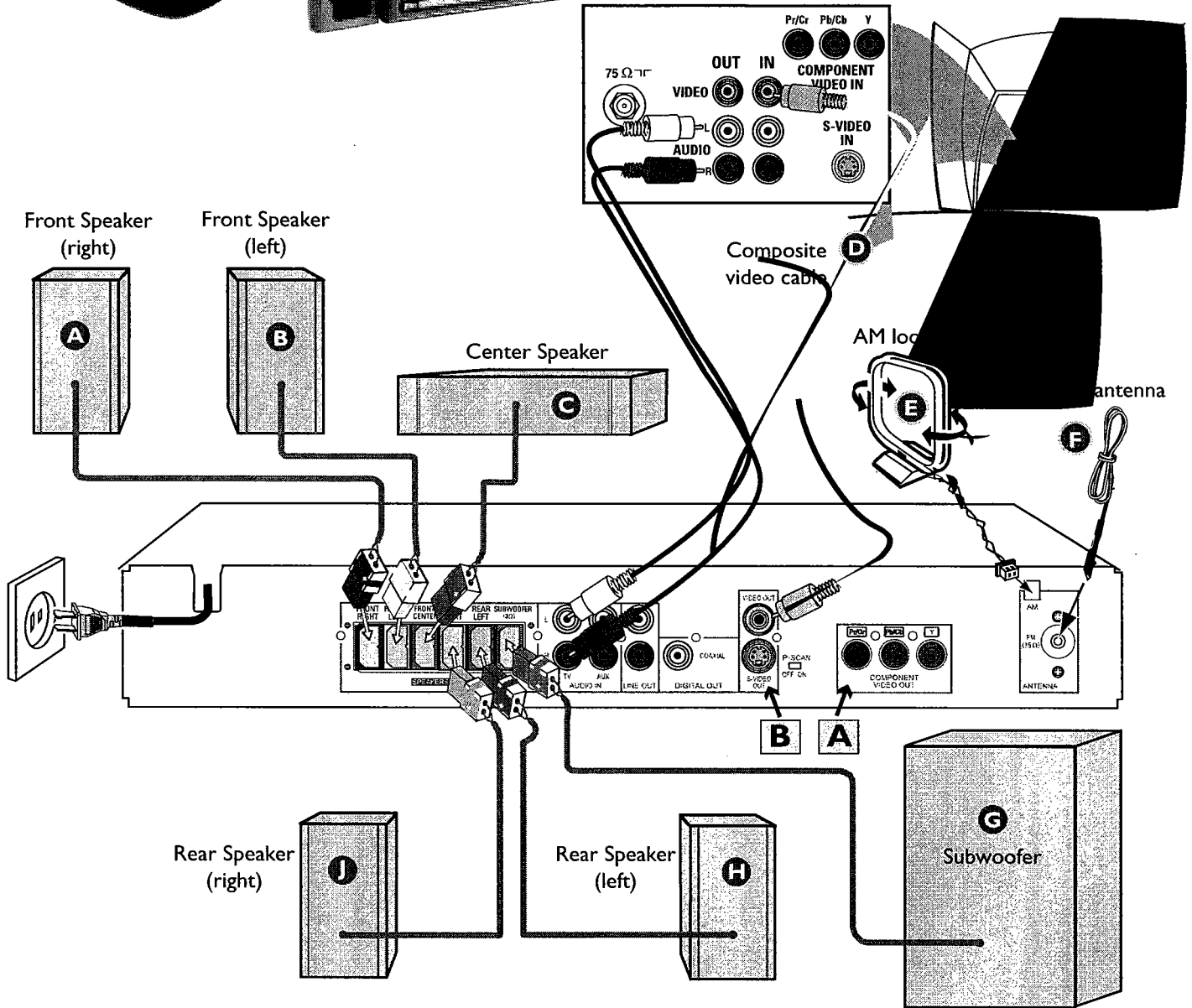

### Helpful Hints

To obtain a better picture quality effect, you can choose to connect an extra video connection if your TV has the same input connector: [A] or [B].

	Use this video cable (not supplied)	If your TV has this video input jack(s)
A		COMPONENT VIDEO IN
B		S-VIDEO IN

**If your TV has only a single Antenna In jack, you will need an accessory RF modulator.** The RF modulator converts the video from the DVD system so it can play through the TV's Antenna connector. Refer to your owner's manual for proper connection (refer to page 13 in the owner's manual).

**Do not switch the P-SCAN to 'ON' position, unless you have connected the DVD system to a Progressive Scan TV using the Component (Pr/Cr Pb/Cb Y) video jacks.**

When listening to TV programs, press TV/AV button on the remote to

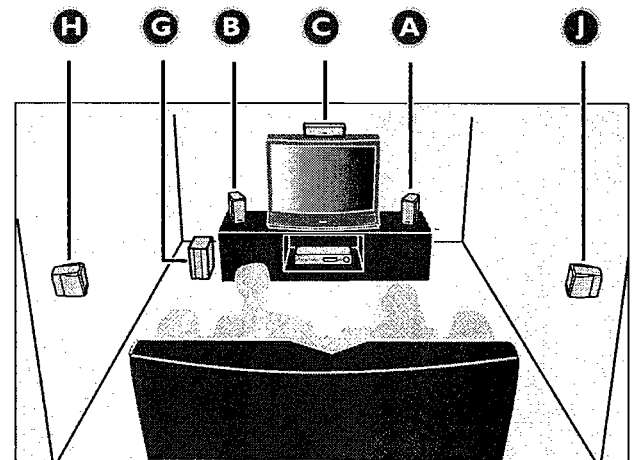



## Playing a disc

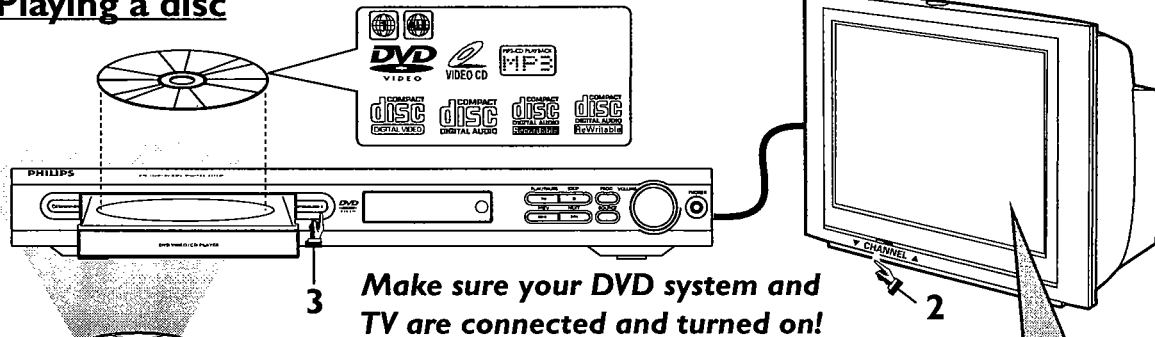

**3** Make sure your DVD system and TV are connected and turned on!

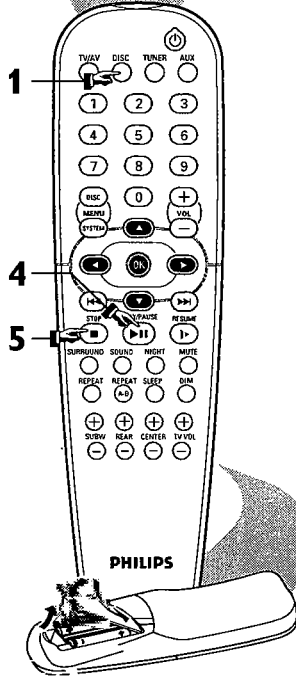

**1** Press **DISC** on the remote control.

You can also press the **SOURCE** button on the front panel until "DISC" appears on the display panel.

**2** Turn on the TV and select the correct **Video In** mode.

You should see the blue DVD background screen on the TV (if no disc in the DVD system.)

**3** Press **OPEN/CLOSE** ▲ on the front of the DVD system and load a disc, then press **OPEN/CLOSE** ▲ again to close the disc tray.

Make sure the disc label is facing up. For double-sided discs, load the side you want to play face up.

**4** Press **▶ II** to start playback.

If a disc menu appears, use ▲▼◀▶ buttons on the remote to make the necessary selection, then press **OK** to confirm. Or, use the numeric keypad on the remote to select features. Follow the instructions given in the disc menu.

**5** To stop playback, press **STOP** ■.

## No picture?

Check the **AV (Audio/Video) mode** on your TV.

- \* Usually this channel is between the lowest and highest channels and may be called **FRONT**, **A/V IN**, or **VIDEO**.
- \* Or, you may go to channel 1 on your TV, then press the **Channel down** button repeatedly until you see the **Video In** channel.
- \* Or, your TV remote control may have a button or switch that chooses different video modes.
- \* Do not use channel 3 or 4 on the TV unless you are using an RF modulator.
- \* See your TV manual for more details.

## Using the DVD setup menu

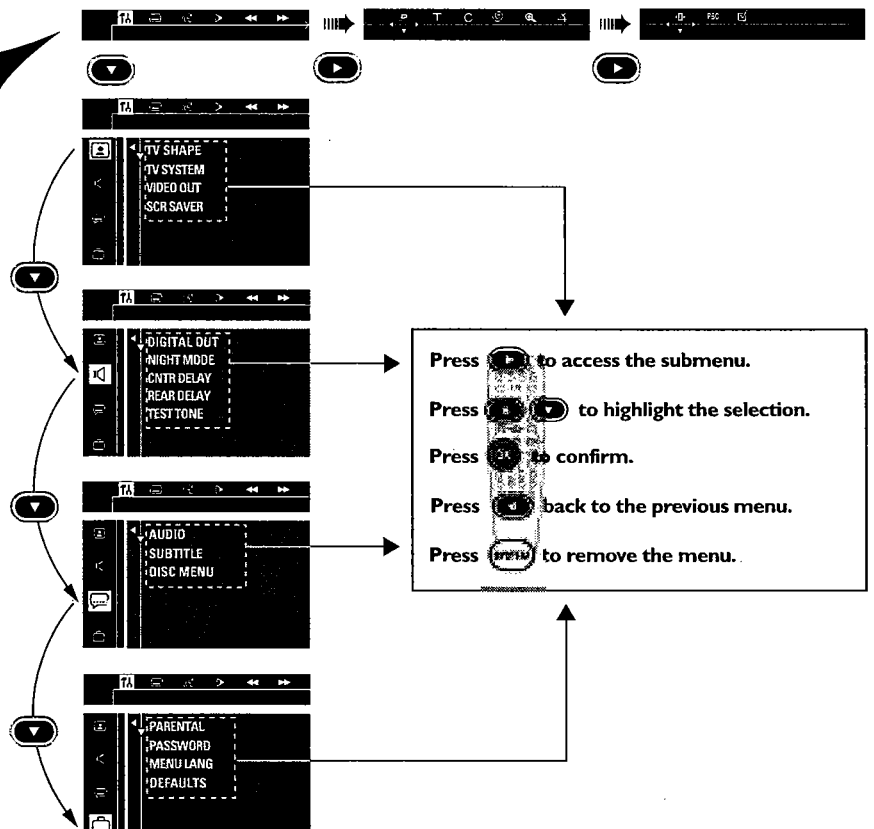
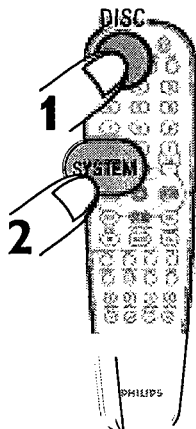
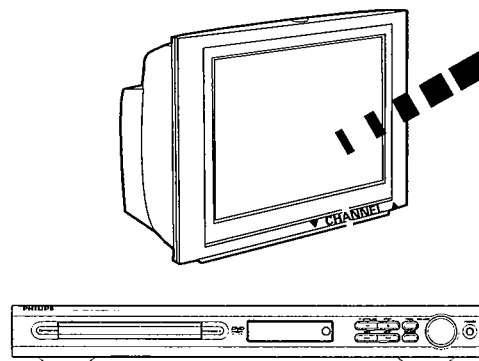



# Guía de utilización rápida

## En primer lugar conecte ...

- (A) Altavoz delantero (derecha)
- (B) Altavoz delantero (izquierdo)
- (C) Altavoz central
- (D) Cable de vídeo compuesto
- (E) Antena de cuadro AM
- (F) Antena de alambre FM
- (G) Subwoofer
- (H) Altavoz trasero (izquierdo)
- (J) Altavoz trasero (derecho)

## ...y después reproduzca

### Consejo útil

Puede hacer una conexión de vídeo extra con una de las opciones siguientes si su televisor tiene el mismo conector de entrada : [A] o [B].

	Utilice este/estos cable(s) de vídeo (no suministrado)	Si su televisor tiene este/ estos conector(es) de entrada de vídeo
A		
B		



**Si su televisor solamente tiene un conector de entrada de antena, necesitará un modulador de RF accesorio.**

El modulador de RF convierte el vídeo del sistema DVD de forma que pueda reproducirse a través del conector de antena del televisor. Para una conexión correcta, consulte su manual del propietario (Consulte la página 49).



**No ponga P-SCAN a la posición 'ON', a menos que haya conectado el sistema DVD a un televisor de exploración progresiva utilizando los conectores de vídeo Componente (Pr/Cr Pb/Cb Y).**

**Cuando escuche programas de televisión, pulse el botón TV/AV en el control remoto para ajustar el sistema DVD al modo de TV/AV para que se oiga el sonido.**

**Si desea conectar su VCR, véase la página 51 del manual del usuario para más detalles.**

## Reproducción de un disco

**Asegúrese de que su sistema de DVD y su televisor estén conectados y encendidos!**

### 1 Pulse DISC en el control remoto.

También puede pulsar SOURCE en el panel delantero hasta que en el panel de visualización aparezca "DISC".

### 2 Encienda el televisor y seleccione el modo de entrada de vídeo correcto.

Debería ver la pantalla de fondo azul de DVD (si no hay disco en el sistema DVD).

### 3 Pulse OPEN/CLOSE ▲ en la parte delantera del sistema DVD y coloque un disco, y vuelva pulsar el botón OPEN/CLOSE ▲ correspondiente para cerrar la bandeja de discos.

Asegúrese de que la etiqueta del disco esté cara arriba. En el caso de discos de dos caras, coloque el disco con la cara que quiere reproducir hacia arriba.

### 4 Pulse ► II para iniciar la reproducción.

Si aparece un menú de disco, utilice los botones ▲ ▼ ◀ ▶ del control remoto para realizar la selección necesaria y después pulse OK para confirmarla. O utilice el teclado numérico del control remoto para seleccionar funciones. Siga las instrucciones dadas en el menú del disco.

### 5 Para detener la reproducción, pulse STOP ■.

## ¿No imagen!!

**Compruebe el modo (AV/Audio/Video) en su televisor.**

- \* Normalmente, estos canales se encuentran entre los canales más altos y más bajos y pueden llamarse FRONT, AV IN o VIDEO.
- \* O, puede ir al canal 1 de su televisor y pulsar el botón de reducción de número de canal hasta que vea el canal de entrada de vídeo.
- \* O, el control remoto de su televisor puede tener un botón o interruptor que seleccione diferentes modos de vídeo.
- \* No utilice el canal 3 o 4 de su televisor a menos que se utilice un modulador de RF.
- \* Para más detalles, consulte el manual de su televisor.

## Utilización del menú de configuración de DVD

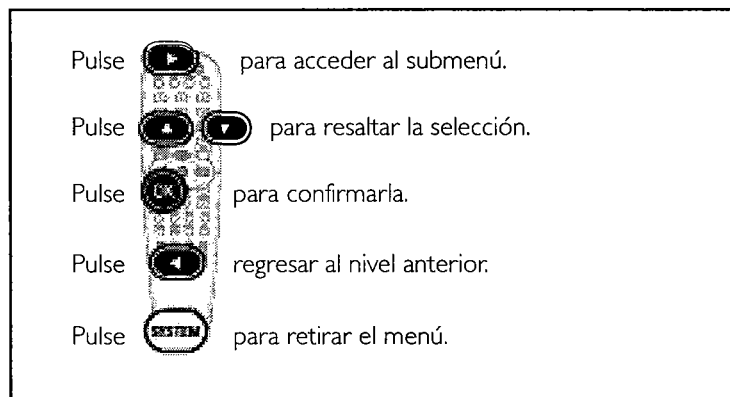



# Chemical Equilibrium

## Introduction

Chemical equilibrium is a state where the concentrations of reactants and products remain constant over time. It is reached when the forward and reverse reaction rates are equal.

## Equilibrium Constant

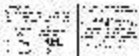

The equilibrium constant,  $K_c$ , is a ratio of the concentrations of products to reactants, each raised to the power of its stoichiometric coefficient.

## Le Chatelier's Principle

Le Chatelier's Principle states that if a system at equilibrium is subjected to a change in concentration, temperature, or pressure, the system will adjust itself to counteract the change and re-establish equilibrium.

- Increasing the concentration of a reactant shifts the equilibrium to the right.
- Increasing the concentration of a product shifts the equilibrium to the left.
- Increasing the temperature of an exothermic reaction shifts the equilibrium to the left.
- Increasing the temperature of an endothermic reaction shifts the equilibrium to the right.
- Increasing the pressure of a reaction with fewer moles of gas shifts the equilibrium to the side with fewer moles.



## Applications

### Industrial Processes

- 1. Haber process for ammonia synthesis
- 2. Contact process for sulfuric acid production
- 3. Ostwald process for nitric acid production
- 4. Water-gas shift reaction

# Index

---

English ..... 8

Español ..... 43

English

Español

Page 1

Page 2

Page 3

Page 4

# Contents

## General Information

Supplied accessories .....	9
Care and safety information .....	9

## Connections

Step 1: Set up the speakers .....	10
Step 2: Placing the speakers and subwoofer .....	10
Step 3: Connecting speakers and subwoofer .....	11
Step 4: Connecting TV .....	12
Using Composite Video jack .....	12
Using Component Video jack (Pr/Cr Pb/Cb Y) .....	12
Using S-Video jack .....	13
Using an accessory RF modulator .....	13
Step 5: Connecting FM/AM antennas .....	14
Step 6: Connecting the power cord .....	14

## Connections (optional)

Connecting a VCR or Cable/Satellite Box ....	15
Viewing and listening to the playback .....	15
Using the VCR for recording DVD playback .....	15
Connecting digital audio equipment .....	15
Digital Recording .....	15

## Functional Overview

Main unit and remote control .....	16
Control buttons available on the remote only .....	17

## Getting Started

Step 1: Inserting batteries into the remote control .....	18
Using the remote control to operate the system .....	18
Step 2: Setting the TV .....	18
Selecting the color system that corresponds to your TV .....	19
Setting the TV shape .....	19
Step 3: Setting the speakers .....	20
Test Tone - turning on/off .....	20
Adjusting the delay time .....	20
Adjusting the speaker output levels .....	20
Step 4: Setting language preferences .....	21
On-screen display (OSD) language .....	21
Audio, Subtitle and Disc Menu language ..	21

## Disc Operations

Playable discs .....	22
Playing discs .....	22
Using the Disc Menu .....	23
Basic playback controls .....	23
Resuming playback from the last stopped point .....	23
Selecting various repeat functions .....	24
Repeat play mode .....	24
Repeating a section within a chapter/track (DVD/VCD/CD) .....	24
Program favorite tracks (audio CDs and VCDs) .....	24
Clearing the program .....	24
Using the menu bar to program .....	25
Playing MP3/Picture disc (Kodak, JPEG) .....	25

## DVD Setup Menu Options

Using the menu bar .....	26
Using the Setup Menu .....	27
Setting the video output .....	27
Screen saver - turning on/off .....	28
Setting the digital output .....	28
Night mode- turning on/off .....	29
Restoring the original settings .....	29
Restricting playback by parental control ..	30
Changing the password .....	31

## Tuner Operations

Tuning to radio stations .....	32
Presetting radio stations .....	32
Automatic presetting .....	32
Manual presetting .....	32
Selecting a preset radio station .....	32
Deleting a preset radio station .....	32

## Other Functions

Sound Control .....	33
Selecting surround sound .....	33
Selecting digital sound effects .....	33
Volume Control .....	33
Dimming system's display screen .....	33
Using the remote to operate 'Philips' television .....	34
Setting the Sleep timer .....	34

## Specifications .....

## Troubleshooting .....

## Glossary .....

## Limited Warranty .....

10/10/10

10/10/10  
10/10/10  
10/10/10

10/10/10  
10/10/10  
10/10/10

10/10/10  
10/10/10  
10/10/10

10/10/10  
10/10/10  
10/10/10

10/10/10  
10/10/10  
10/10/10

10/10/10  
10/10/10  
10/10/10

10/10/10  
10/10/10  
10/10/10

10/10/10  
10/10/10  
10/10/10

10/10/10  
10/10/10  
10/10/10

10/10/10  
10/10/10  
10/10/10

10/10/10  
10/10/10  
10/10/10

10/10/10  
10/10/10  
10/10/10

10/10/10  
10/10/10  
10/10/10

10/10/10  
10/10/10  
10/10/10

10/10/10  
10/10/10  
10/10/10

10/10/10  
10/10/10  
10/10/10

10/10/10  
10/10/10  
10/10/10

10/10/10  
10/10/10  
10/10/10

10/10/10  
10/10/10  
10/10/10

10/10/10  
10/10/10  
10/10/10

10/10/10  
10/10/10  
10/10/10

## Supplied accessories

Composite video cable (yellow)



Audio cable (white, red)

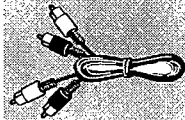

FM wire antenna

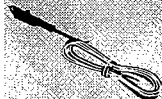

AM loop antenna

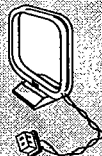

Remote Control and two AA batteries (12nc: 3139 238 04481)

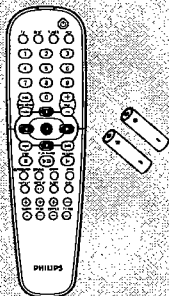

speaker brackets and screws (4x)



## Care and safety information

### Avoid high temperatures, moisture, water and dust

– Do not expose the system, batteries or discs to humidity, rain, sand or excessive heat (caused by heating equipment or direct sunlight.) Always keep the disc tray closed to avoid getting dust on the lens.

### Avoid condensation problem

– The lens may cloud over when the player is suddenly moved from cold to warm surroundings, making it impossible to play a disc. Leave the player in the warm environment until the moisture evaporates.

### Do not block the vents

– Do not operate the DVD system in an enclosed cabinet and allow about 10 cm (4 inches) of free space all around the player for adequate ventilation.

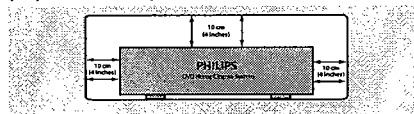

### Care of disc

– To clean a CD, wipe it in a straight line from the center toward the edge using a soft, lint-free cloth. Do not use cleaning agents, as they may damage the disc.

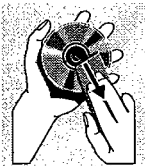

– Write only on the printed side of a CD-R/CD-RW and only with a soft felt-tipped pen.  
– Handle the disc by its edge, do not touch the surface.

### Care of the cabinet

– Use a soft cloth slightly moistened with a mild detergent solution. Do not use a solution containing alcohol, spirits, ammonia or abrasives.

### Finding a suitable location

– Place the player on a flat, hard, stable surface.



# Connections

## Step 1: Set up the speakers

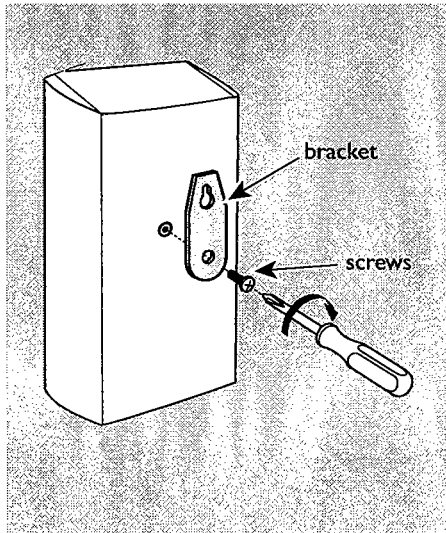

You can choose to hang the speakers on the wall. Attach the supplied bracket firmly to the rear of speakers using the supplied screws. Then mount a screw (not supplied) on the wall where the speaker is to be hung and hook the speaker securely onto the mounted screw.

### CAUTION!

**You should get a qualified person to attach the brackets to the wall. DO NOT do it by yourself to avoid unexpected damage to the equipment or injury to personnel.**

#### Helpful Hints:

- The rear speakers are labelled as REAR L (left) or REAR R (right).
- The front speakers are labelled as FRONT L (left) or FRONT R (right).

## Step 2: Placing the speakers and subwoofer

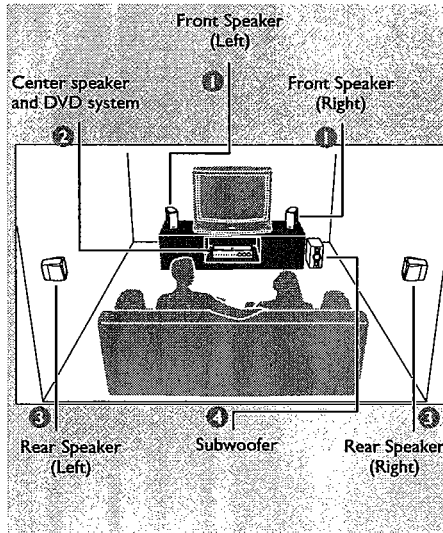

For best possible surround sound, all the speakers (except subwoofer) should be placed at the same distance from the listening position.

- 1 Place the front left and right speakers at equal distances from the TV and at an angle of approximately 45 degrees from the listening position.
- 2 Place the center speaker above the TV or the DVD system so that the center channel's sound is localized.
- 3 Place the rear speakers at normal listening ear level facing each other or hang on the wall.
- 4 Place the subwoofer on the floor near the TV.



## Step 3: Connecting speakers and subwoofer

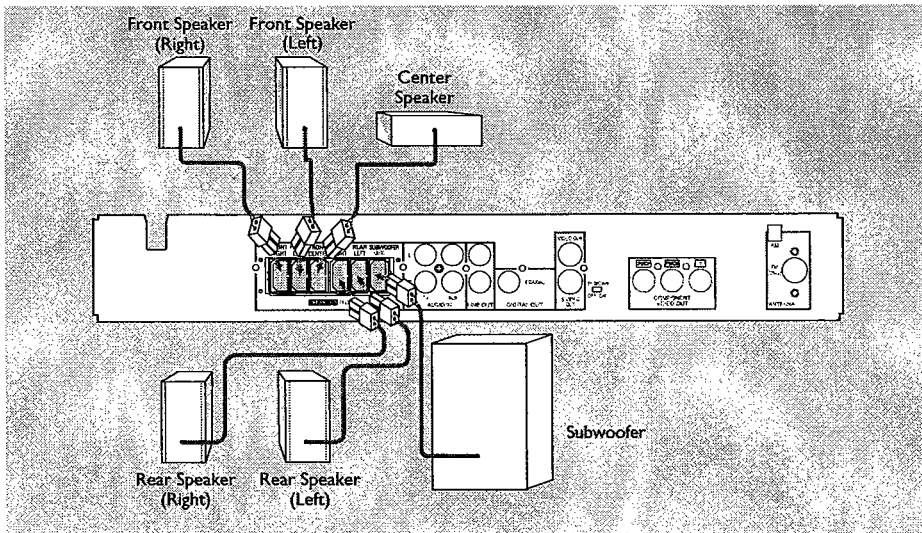

Connect the supplied speaker systems using the fixed speaker cables by matching the colors of the jacks and speaker cables.

### Helpful Hint:

— Ensure that the speaker cables are correctly connected. Improper connections may damage the system due to short-circuit.

# Connections

## Step 4: Connecting TV

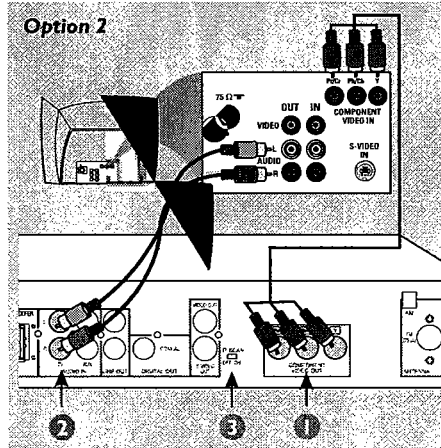
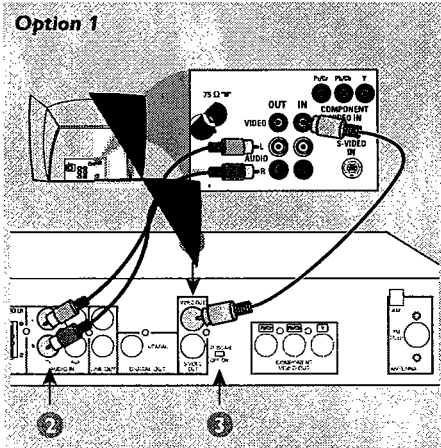

### IMPORTANT!

- You only need to make one video connection from the following options, depending on the capabilities of your TV.
- Connect the DVD system directly to the TV.

### Using Composite Video jack

- 1 Use the supplied composite video cable (yellow) to connect the DVD system's **VIDEO OUT** jack to the video input jack (or labeled as A/V In, CVBS, Composite or Baseband) on the TV.
- 2 To hear the TV channels through this DVD system, use the supplied audio cables (white/red) to connect **AUDIO IN-TV** jacks to the corresponding **AUDIO OUT** jacks on the TV.
- 3 Set the **P-SCAN** switch to 'OFF'.

### IMPORTANT!

The progressive scan video quality is only possible when using **Pr/Cr Pb/Cb Y**, and a progressive scan TV is required.

### Using Component Video jacks (Pr/Cr Pb /Cb Y)

- 1 Use a component video cables (red/blue/green - not supplied) to connect the DVD system's **Pr/Cr Pb/Cb Y** jacks to the corresponding Component video input jacks (or labeled as Pr Pb Y or YUV) on the TV.
- 2 To hear the TV channels through this DVD system, use the supplied audio cables (white/red) to connect **AUDIO IN-TV** jacks to the corresponding **AUDIO OUT** jacks on the TV.
- 3 If you are using a Progressive Scan TV (TV must indicate Progressive Scan or ProScan capability), set the **P-SCAN** switch to 'ON'. Otherwise, set it to 'OFF'.

### Helpful Hint:

- You have to power off the DVD system or switch to standby mode before changing the P-SCAN switch setting.

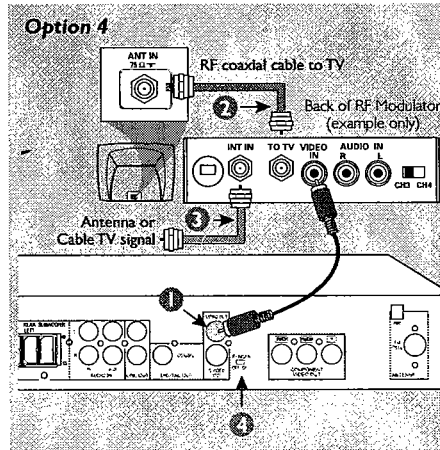
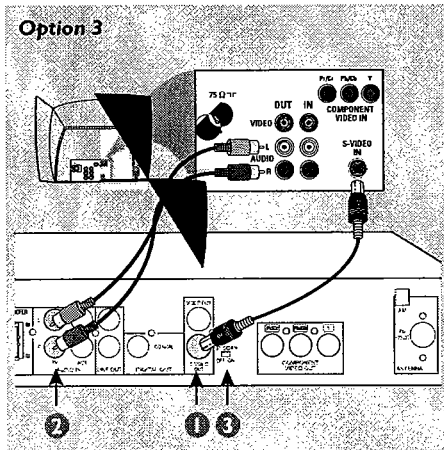

### IMPORTANT!

If S-Video is used for DVD playback connection, the system's **VIDEO OUT** setting will need to be changed accordingly. Details are on page 27.

#### Using S-Video jack

- 1 Use an S-video cable (not supplied) to connect the DVD system's **S-VIDEO OUT** jack to the S-Video input jack (or labeled as Y/C or S-VHS) on the TV.
- 2 To hear the TV channels through this DVD system, use the supplied audio cables (white/red) to connect **AUDIO IN-TV** jacks to the corresponding **AUDIO OUT** jacks on the TV.
- 3 Set the **P-SCAN** switch to 'OFF'.

### IMPORTANT!

If your TV only has a single Antenna In jack (labeled as 75 ohm or RF In), you will need an RF modulator in order to view DVD playback on the TV. See your electronics retailer or contact Philips for details on RF modulator availability and operations.

#### Using an accessory RF modulator

- 1 Use the supplied composite video cable (yellow) to connect the DVD system's **VIDEO OUT** jack to the video input jack on the RF modulator.
- 2 Use an RF coaxial cable (not supplied) to connect **ANTENNA OUT** or **TO TV** jack on the RF modulator to the **ANTENNA IN** jack on the TV.
- 3 Connect the Antenna or Cable TV service signal to the **ANTENNA IN** or **RF IN** jack on the RF modulator. (It may have been connected to your TV previously. Disconnect it from the TV.)
- 4 Set the **P-SCAN** switch to 'OFF'.

# Connections

## Step 5: Connecting FM/AM antennas

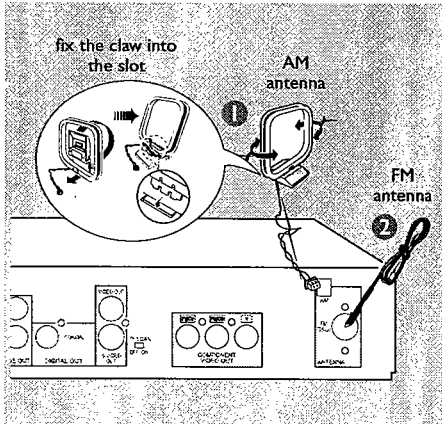

- 1 Connect the supplied AM loop antenna to the **AM** jack. Place the AM loop antenna on a shelf or attach it to a stand or wall.
- 2 Connect the supplied FM antenna to the **FM** (75Ω) jack. Extend the FM antenna and fix its ends to the wall.

For better FM stereo reception, connect an external FM antenna (not supplied.)

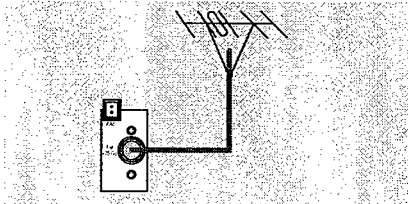

### Helpful Hints:

- Adjust the position of the antennas for optimal reception.
- Position the antennas as far as possible from your TV, VCR or other radiation source to prevent unwanted interference.

## Step 6: Connecting the power cord

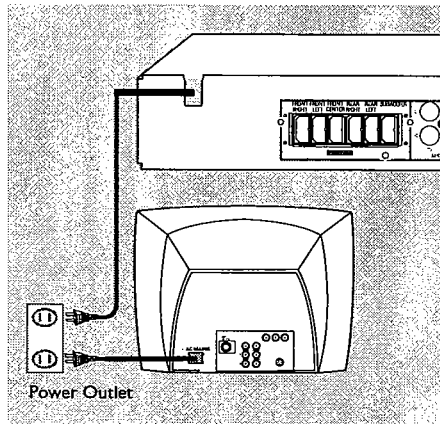

**After everything is connected properly, plug the AC power cord into the power outlet.**

Never make or change any connections with the power switched on.

### Helpful Hint:

- Refer to the type plate on the rear or bottom of the system for identification and supply ratings.

## Connections (optional)

### Connecting a VCR or Cable/Satellite Box

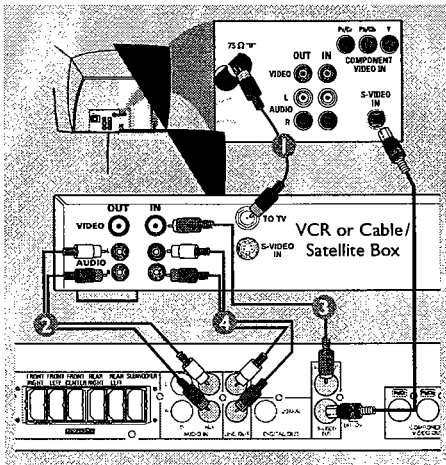

#### Viewing and listening to the playback

- 1 Connect the VCR or Cable/Satellite Box to the TV as shown.
- 2 Connect the DVD system's **AUDIO IN-AUX** jacks to the AUDIO OUT jacks on the VCR or cable/satellite box.

Before starting operation, press **AUX** on the remote to select "AUX" in order to activate the input source.

#### Using the VCR for recording DVD playback

- 3 Connect the DVD system's **VIDEO OUT** jack to the VIDEO IN jack on the VCR.
- 4 Connect the DVD system's **LINE OUT** jacks to the AUDIO IN jacks on the VCR. This will allow you to make analog stereo (two channel, right and left) recordings.

**To view DVD playback while recording,** you must connect the DVD system to your TV using S-VIDEO (as shown above) or Component (Pr/Cr Pb/Cb Y) video connection.

### Connecting digital audio equipment

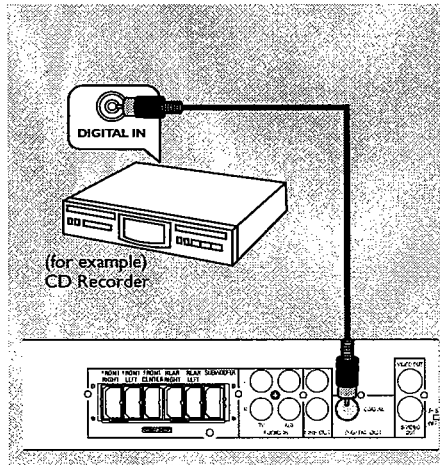

#### Digital Recording

- Connect the DVD system's **DIGITAL OUT-COAXIAL** jack to the DIGITAL COAXIAL IN jack on a digital recording device (such as Dolby Digital decoder, CD recorder.)

Before starting operation, set the DIGITAL OUTPUT according to the audio connection. (See page 28 "Setting the digital output".)

#### Helpful Hints:

- Some DVDs are copy-protected. You cannot record the disc through a VCR or digital recording device.
- Always refer to the owner's manual of the other equipment for complete connection and usage details.

# Functional Overview

## Main unit and remote control

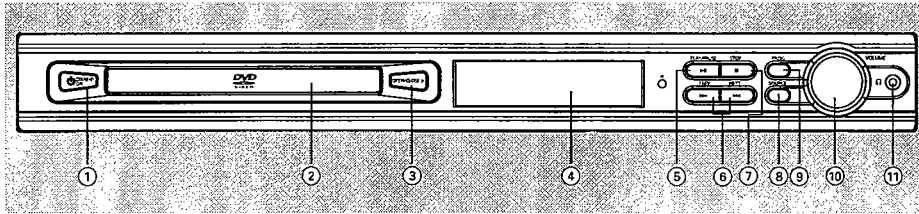

### ① STANDBY ON

- Switches to standby mode or turns on the system.

### ② Disc tray

- Opens/Closes the disc tray.

### ③ OPEN/CLOSE ▲ (DISC mode only)

- Opens/Closes the disc tray.

### ④ System display panel

### ⑤ ► II PLAY/PAUSE

- DISC: starts/pauses playback. (see pages 22, 23)

### ⑥ ◀◀ PREV / ▶▶ NEXT

- DISC: \*searches backward/forward or selects a track. (see page 23)
- TUNER: tunes the radio frequency up/down. (see pages 32)
- TV: selects previous/next channel on Philips TV (on remote only.)

### ⑦ ■ STOP

- Exits an operation.
- DISC: stops playback or clears a program. (see page 23, 24)
- TUNER: \*erases a preset radio station (see page 32).

### ⑧ SOURCE

- Selects the relevant active mode :TV, DISC, TUNER (FM/AM) or AUX.

### ⑨ PROG

- DISC: starts programming. (see page 24)
- TUNER: starts manual preset programming. (see page 32)

### ⑩ VOLUME (VOL + -)

- Adjusts the volume level.

### ⑪ PHONES

- Plugging in the headphones jack. The speakers output will be cancelled.

\* = Press and hold the button for more than two seconds.

**Control buttons available on the remote only**

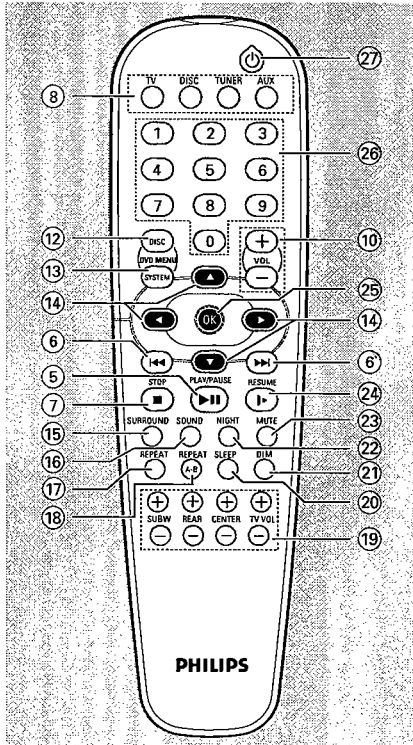

- ⑫ **DISC MENU**  
– Enters disc contents menu. (see page 23)
- ⑬ **SYSTEM MENU** (DISC mode only)  
– Enters or exits system setup menu. (see pages 26–27)
- ⑭ ◀▶▲▼  
– Selects movement direction in the menu.  
– Use ◀▶ to select a preset radio station. (see page 32)
- ⑮ **SURROUND**  
– Selects multichannel surround (Dolby Digital, Dolby Pro Logic or Dolby Pro Logic II) or stereo mode. (see page 33)

- ⑯ **SOUND**  
– Selects a sound effect. (see page 33)
- ⑰ **REPEAT**  
– Selects various repeat modes. (see page 24)
- ⑱ **REPEAT A-B**  
– Repeats a specific section on a disc. (see page 24)
- ⑲ **SUBW + –**  
– Adjusts subwoofer's sound level.  
**REAR + –**  
– Adjusts rear speakers' sound level.  
**CENTER + –**  
– Adjusts center speaker's sound level.  
**TVVOL + –**  
– Adjusts TV volume (Philips TV only.) (see page 34)
- ⑳ **SLEEP**  
– Sets the sleep timer function. (see page 34)
- ㉑ **DIM**  
– Selects different levels of brightness for display panel. (see page 33)
- ㉒ **NIGHT** (DVD mode only)  
– Optimizes the dynamic of the sound output (see page 29)
- ㉓ **MUTE**  
– Mutes or restores the volume.
- ㉔ **RESUME**  
– Continues disc playback after an interruption. (see page 23)
- ㉕ **OK**  
– Confirms a selection.
- ㉖ **Numeric Keypad (0-9)**  
– Enters a track/title number of the disc.  
– Enters a number of a preset radio station.
- ㉗ **⏻**  
– Switches to standby mode.  
– In TV mode, switches Philips TV on/off.

\* = Press and hold the button for more than two seconds.

# Getting Started

## Step 1: Inserting batteries into the remote control

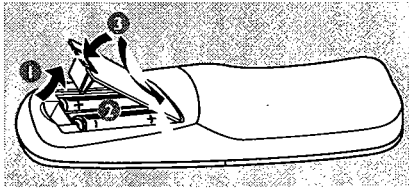

- 1 Open the battery compartment.
- 2 Insert two batteries type R06 or AA, following the indications (+ -) inside the compartment.
- 3 Close the cover.

## Using the remote control to operate the system

- 1 Aim the remote control directly at the remote sensor (IR) on the front panel.
- 2 Select the source you wish to control by pressing one of the source select buttons on the remote control (for example TV, TUNER.)
- 3 Then select the desired function (for example ► II, ◀◀, ▶▶).

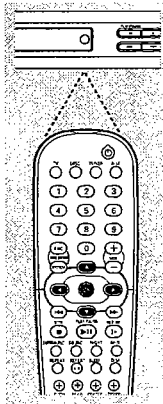

## Step 2: Setting the TV

### IMPORTANT!

Make sure you have completed all the necessary connections. (See pages 12–13 “Connecting TV”.)

- 1 Press **SOURCE** control until “DISC” appears on the display panel (or press **DISC** on the remote.)
- 2 Turn on the TV and set to the correct video-in channel. You should see the blue DVD background screen on the TV.
  - Usually this channel is between the lowest and highest channels and may be called FRONT, A/V IN, or VIDEO. See your TV manual for more details.
  - Or, you may go to channel 1 on your TV, then press the Channel down button repeatedly until you see the Video In channel.
  - Or, the TV remote control may have a button or switch that chooses different video modes.
  - Or, set the TV to channel 3 or 4 if you are using an RF modulator.



### CAUTION!

- Remove batteries if they are exhausted or if the remote is not to be used for a long time.
- Do not use old and new or different types of batteries in combination.
- Batteries contain chemical substances, so they should be disposed of properly.



## Selecting the color system that corresponds to your TV

In order for a DVD to play on this DVD system, the color system of the DVD, the TV and the DVD player should match. Before changing the TV system, ensure that your TV supports the selected color system.

- 1 In disc mode, press **SYSTEM MENU**.  
→ Use the ◀▶▲▼ keys on the remote to navigate in the menu.
- 2 Highlight  icon and press ▼.  
Move to  and press ▶.  
Move to {TV SYSTEM} and press ▶.

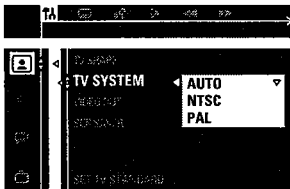

**AUTO** – Select this if the connected TV is compatible with both NTSC and PAL (multi-system.) The output format will be in accordance with the video signal of the disc.



**NTSC** – Select this if the connected TV has the NTSC system. It will change the video signal of a PAL disc (VCD only) and output it to NTSC format.

**PAL** – Select this if the connected TV has the PAL system. It will change the video signal of an NTSC disc and output it to PAL format.

- 3 Press ▲▼ to select a setting and press **OK** to confirm.  
→ Follow the instructions show on the TV to confirm the selection (if any).  
→ If a blank/distorted TV screen appears, wait for 15 seconds for auto recovery.

## Setting the TV shape

Set the aspect ratio of the DVD Player according to the TV you have connected. The format you select must be available on the disc. If it is not, the setting for TV display will not affect the picture during playback.

- 1 In disc mode, press **SYSTEM MENU**.  
→ Use the ◀▶▲▼ keys on the remote to navigate in the menu.
- 2 Highlight  icon and press ▼.  
Move to  and press ▶.  
Move to {TV SHAPE} and press ▶.

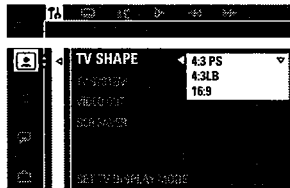

**4:3 PS (PanScan)** –  
Select this if you have a conventional TV and want both sides of the picture to be trimmed or formatted to fit your TV screen.



**4:3 LB (letterbox)** –  
Select this if you have a conventional TV. In this case, a wide picture with black bands on the upper and lower portions of the TV screen will be displayed.



**16:9** – Select this if you have a wide-screen TV.



- 3 Press ▲▼ to select a setting and press **OK** to confirm.

**TIPS:** To return to the previous menu, press ◀.  
To remove the menu, press **SYSTEM MENU**.



# Getting Started

## Step 3: Setting the speakers

You can adjust the delay time (center and rear speakers only) and volume level for individual speakers. These adjustments let you optimize the sound according to your surroundings and setup.

### Test Tone - Turning on/off

If you have turned on the test tone, the test signal will be automatically generated to help you judge the sound level of each speaker.

- 1 In disc mode, press **SYSTEM MENU**.  
→ Use the ◀▶▲▼ keys on the remote to navigate in the menu.
- 2 Highlight  icon and press ▼.  
Move to  and press ▶.  
Move to {TEST TONE} and press ▶.

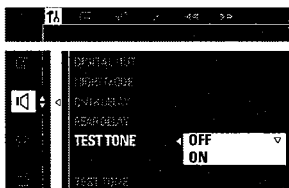

- 3 Press ▲▼ to select a setting.

### Adjusting the delay time

- 4 Press ▲▼ to highlight one of the options below at a time, then press ▶.

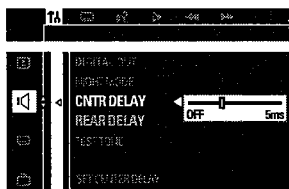

{CNTR DELAY} – Select this to set the delay time in relation to the listening position/distance for the center speaker (5ms, 3ms, 2ms, 1ms or OFF).

{REAR DELAY} – Select this to set the delay time in relation to the listening position/distance for rear speakers (15ms, 12ms, 9ms, 6ms, 3ms or OFF).

- 5 Press ◀▶ to adjust the settings that best suit your surround sound needs.
- 6 Press **OK** to confirm.

### Helpful Hint:

– Use longer delay time settings when the rear speakers are closer to the listener than the front speakers.

### Adjusting the speaker output levels

You can adjust the rear speakers, center speaker and subwoofer output levels by comparing the sound from the front speakers.

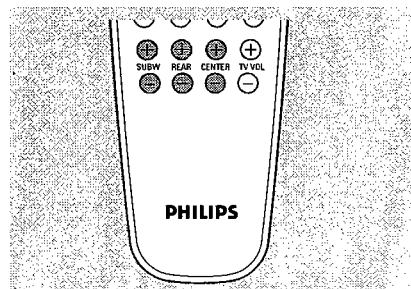

- 7 Press the respective buttons on the remote (**REAR** + –, **CENTER** + – and **SUBW** + –) to adjust the output level between -15dB ~ 10dB.

### Helpful Hint:



– If you have selected Stereo mode, adjusting the center and rear speakers' volume level will have no effect.

**TIPS:** To return to the previous menu, press ◀.  
To remove the menu, press **SYSTEM MENU**.

## Step 4: Setting language preferences

You can select your preferred language settings so that this DVD system will automatically switch to the language for you whenever you load a disc. If the language selected is not available on the disc, the disc's default setting language will be used instead. The OSD (on-screen display) language for the system menu will remain as you set it, regardless of various disc languages.

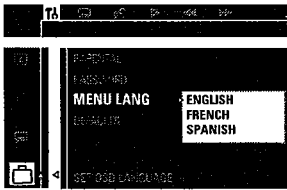

### On-screen display (OSD) language

- 1 In disc mode, press **SYSTEM MENU**.  
→ Use the ◀▶▲▼ keys on the remote to navigate in the menu.
- 2 Highlight  icon and press ▼.  
Move to  and press ▶.  
Move to {MENU LANG} and press ▶.



- 3 Press ▲▼ to select a language and press **OK** to confirm.

### Audio, Subtitle and Disc menu language

- 1 In disc mode, stop playback and press **SYSTEM MENU**.  
→ Use the ◀▶▲▼ keys on the remote to navigate in the menu.
- 2 Highlight  icon and press ▼.  
Move to  and press ▶.  
Move to highlight one of the options below at a time, then press ▶.
  - {AUDIO} (disc's soundtrack)
  - {SUBTITLE} (disc's subtitles)
  - {DISC MENU} (disc's menu)

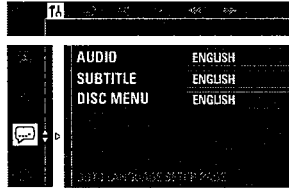

- 3 Press ▲▼ to select a language and press **OK** to confirm.
- 4 Repeat steps 2~3 for other settings.

**TIPS:** To return to the previous menu, press ◀  
To remove the menu, press **SYSTEM MENU**.

# Disc Operations

## IMPORTANT!

-  If the inhibit icon (or X) appears on the TV screen when a button is pressed, it means the function is not available on the current disc or at the current time.
- DVD discs and players are designed with regional restrictions. Before playing a disc, make sure the disc is for the same zone as your player.
- Do not push on the disc tray or put any objects other than discs on the disc tray. Doing so may cause the disc player to malfunction.

## Playable discs

Your DVD home cinema system will play:

- Digital Versatile Discs (DVDs)
- Video CDs (VCDs)
- Super Video CDs (SVCDs)
- Audio Compact Discs (CDs)
- MP3 discs, picture (Kodak, JPEG) files on CD-R(W)
  - JPEG/ISO 9660 format
  - Maximum 12 characters display
  - Supported sampling frequencies : 32 kHz, 44.1 kHz, 48 kHz
  - Supported Bit-rates : 32~256 (kbps), variable bit rates



## Region Codes

DVDs must be labeled for **ALL** regions or for **Region 1** in order to play on this DVD system. You cannot play discs that are labeled for other regions.



### Helpful Hints:

- It may not be possible to play CD-R/RW in all cases due to the type of disc or condition of the recording.
- If you are having trouble playing a certain disc, remove the disc and try a different one. Improperly formatted discs will not play on this DVD system.

## Playing discs

- 1 Press **SOURCE** control until "DISC" appears on the display panel (or press **DISC** on the remote.)
- 2 Turn on the TV power and set to the correct Video In channel. (See page 18 "Setting the TV".)  
→ You should see the blue DVD background screen on the TV.
- 3 Press the **OPEN/CLOSE**  to open the disc tray and load a disc, then press the button again to close the disc tray.  
→ Make sure the disc label is facing up. For double-sided discs, load the side you want to play face up.
- 4 Press **▶||** to start playback.  
→ If a disc menu shows on the TV, see next page on "Using the Disc Menu."  
→ If the disc is locked by parental control, you must enter your four-digit password (see page 30-31.)

**TIPS:** The operating features described here might not be possible for certain discs. Always refer to the instructions supplied with the discs.

## Using the Disc Menu

Depending on the disc, a menu may appear on the TV screen once you load in the disc.

### To select a playback feature or item

- Use the ◀▶ ▲▼ keys or **numeric keypad (0-9)** on the remote, then press **OK** to start playback.

### To access the menu

- Press **DISC MENU** on the remote.

### For VCDs with Playback Control (PBC) feature (version 2.0 only)

- During playback, pressing **DISC MENU** will return to the menu screen (if PBC is on.)  
→ Use ◀◀◀ / ▶▶▶ to select a play option and press **OK** to confirm or use the **numeric keypad (0-9)**.

## Basic playback controls

### Pausing playback

- Press ▶||.
- To resume normal playback, press ▶|| again.

### Selecting another track/chapter

- Press ◀◀◀ / ▶▶▶ or use the **numeric keypad (0-9)** to key in a track/chapter number.  
→ If repeat mode is active, pressing ◀◀◀ / ▶▶▶ will replay the same track/chapter.

### Searching backward/forward

- Press and hold ◀◀◀ / ▶▶▶, then press ▶|| to resume normal playback.  
→ While searching, pressing and holding ◀◀◀ / ▶▶▶ again will increase the search speed.

### Stopping playback

- Press ■.

### Resuming playback from the last stopped point (DVD/VCD/CD)

- When play is stopped and the disc has not been ejected, press **RESUME**.

### To cancel the resume mode

- When play is stopped, press ■ again.

### Helpful Hints:

- Open the disc tray or disconnect the DVD system from the power supply will cancel the resume option.
- For VCD disc, pressing **RESUME** button will turn off the PBC mode and playback will start from the beginning.

**TIPS:** The operating features described here might not be possible for certain discs. Always refer to the instructions supplied with the discs.

## Selecting various repeat functions

### Repeat play mode

- While playing a disc, press **REPEAT** to select various repeat mode.  
→ "REPEAT" icon will appear on the display, except REPEAT OFF mode.

### DVD

CHAPTER REPEAT ON →  
TITLE REPEAT ON → REPEAT-OFF

### VCD/SVCD/CD

REPEAT-ONE (repeat the current track) → REPEAT-ALL → REPEAT-OFF

### MP3

REPEAT-ONE → REPEAT-ALBUM → REPEAT-ALL → REPEAT-OFF

### Helpful Hint:

– For VCD, repeat playback is not possible if the PBC mode is switched on.

### Repeating a section within a chapter/track

- ① While playing a disc, press **REPEAT A-B** at the starting point.
- ② Press **REPEAT A-B** again at the point to end the section.  
→ The section A and B can be set only within the same chapter/track.  
→ The section will now repeat continuously.
- ③ Press **REPEAT A-B** again to resume normal playback.

## Program favorite tracks (audio CDs and VCDs)

You can play the contents of the disc in the order you want by programming the order of the tracks to be played. Up to 99 tracks can be stored.

- ① Stop playback, then press **PROG** on the front panel to enter program mode.
- ② Use the **numeric keypad (0-9)** to enter a valid track number.  
→ "FULL" will appear if you have programmed 99 tracks.
- ③ Press **OK** to store the track.
- ④ Repeat steps ②~③ to select other tracks.
- ⑤ Press **▶ ||** to start program playback.
- ⑥ Press **■** to stop playback or exit program mode.

### Clearing the program

- Stop playback, then press the **■** again.  
→ "PROG CLR" appears.

### Helpful Hints:

– If the DVD system is disconnected from the power supply, it will erase the program.  
– For VCD, the program option is only possible if the PBC mode is turned off.

**TIPS:** The operating features described here might not be possible for certain discs. Always refer to the instructions supplied with the discs.

## Using the menu bar to program

### IMPORTANT!

You have to turn on your TV and set to the correct Video In channel. (See page 18 "Setting the TV".)

- ❶ Stop playback, then press **SYSTEM MENU**.  
→ The menu bar will appear across the top of the TV screen.
- ❷ Press ◀▶ to select  and press ▼ to enter the program menu.



- ❸ Use the **numeric keypad (0-9)** to enter the track number to be programmed.  
→ "FULL" will appear if you have programmed 99 tracks.
  - ❹ Press ▶|| to start program playback.
- To clear the program**
- Stop playback, then press ■ again.

## Playing MP3/Picture disc (Kodak, JPEG)

### IMPORTANT!

You have to turn on your TV and set to the correct Video In channel. (See page 18 "Setting the TV".)

- ❶ Load an MP3/Picture (Kodak, JPEG) disc.  
→ The disc reading time may exceed 30 seconds due to the complexity of the directory/file configuration.
- ❷ Playback will start automatically.  
→ The album/picture menu appears on the TV screen. If not, press DISC MENU on the remote.
- ❸ Use ◀▶ ▲ ▼ keys to select a desired album, then press **OK** to open the folder (for MP3 disc only).  
→ The title menu appears on the TV screen.
- ❹ Use ◀▶ ▲ ▼ keys to select a desired title, then press **OK** to start playback.
- You can also use the **numeric keypad (0-9)** to enter your choice.

During playback, you can;

- Press ◀◀ / ▶▶ to select another title/picture in the current folder.
- Use ◀▶ ▲ ▼ keys to rotate/flip the picture files.
- Press ▶|| to pause/resume playback.
- ❺ To stop playback, press ■.

### Helpful Hints:

- Due to the recording nature of Digital Audio MP3 (DAM), only digital audio music will play.
- It is normal to experience an occasional "skip" while listening to your MP3 discs.
- It may not be possible to play certain MP3 or JPEG disc due to the configuration and characteristics of the disc or condition of the recording.
- For multi-session discs with different formats, only the first session will be available.

**TIPS:** The operating features described here might not be possible for certain discs. Always refer to the instructions supplied with the discs.

# DVD Setup Menu Options

## Using the menu bar

You can continue a number of operations directly via the multiple menu bars on the TV screen without interrupting the disc playback. The exception is when you enter **SETUP MENU** (SETUP MENU), after which the playback will pause.

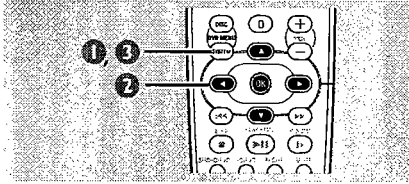

- 1 In disc mode, press **SYSTEM MENU**.  
→ The menu bar will appear across the top of the TV screen.

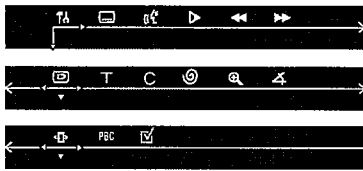

- 2 Use **◀▶▲▼** keys on the remote to navigate in the menu.  
→ Press **◀▶** to move through the menu bar.  
→ Press **▼** to enter the selection. If there are multiple choices available, press **▼** repeatedly to select.
- 3 Press **SYSTEM MENU** again to remove the menu.

### IMPORTANT!

– Some operations may be different or restricted, depending on the disc format. Refer to the jacket or case of the disc you are playing.  
– Changing the Subtitle Language and Audio Language from the menu bar will only apply to the current disc, it will not change the default preset.

	<b>SUBTITLE</b> Select a subtitle language available on the DVD.
	<b>AUDIO</b> DVD : Select an audio soundtrack language available on the DVD. VCD : Select audio channels : LEFT VOCAL, RIGHT VOCAL, MONO LEFT, MONO RIGHT or STEREO.
	<b>SLOW MOTION</b> Select a slow playback speed. The volume will be muted. To resume normal playback, press <b>▶ II</b> . DVD : SF x1/2, SF x1/4, SF x1/8. SR x1/2, SR x1/4, SR x1/8, OFF. VCD : SF x1/1, SF x1/2, SF x1/3, OFF. (SF - Slow Forward, SR- Slow Reverse)
	<b>FAST REVERSE (FR)</b> DVD / MP3 : FR x2, FR x4, FR x6, FR x8, OFF. VCD / CD : FR x1, FR x2, FR x3, FR x4, OFF.
	<b>FAST FORWARD (FF)</b> DVD / MP3 : FF x2, FF x4, FF x6, FF x8, OFF. VCD / CD : FF x1, FF x2, FF x3, FF x4, OFF.  Select a search speed (FR - backward, FF - forward). The volume will be muted. To resume normal playback, press <b>▶ II</b> .
	<b>STATUS</b> Allows viewing of the current status of the disc. The information will vary depending on the disc format.
	<i>Available on DVD only</i> <b>TITLE SEARCH (TITLE XX:YY)</b> Select a Title for playback to begin.
	<b>CHAPTER SEARCH (CHAPTER XX:YY)</b> Select a Chapter for playback to begin.  "XX" - current title/chapter number. "YY" - total number of title/chapter. Use the <b>numeric keypad (0-9)</b> to change the "XX" number, then press <b>OK</b> .
	<b>TIME SEARCH (TIME _ : _ : _)</b> Use the <b>numeric keypad (0-9)</b> to enter the time (hours, minutes and seconds) at which you want playback to begin (for DVD and VCD with PBC-OFF only)
	<b>ZOOM</b> Select an enlarge picture ratio : x1.5, x2 or x4. Use <b>◀▶▲▼</b> keys to move within the enlarged picture on the TV. To resume normal playback, select 'ZOOM OFF' from the menu.
	<b>ANGLE (for DVD only)</b> Select to view the same scene from different angles if the DVD is recorded with multiple angles.
	<b>STEP FORWARD</b> Select to advance the still picture one frame forward. To resume normal playback, press <b>▶ II</b> .
	<b>PBC ON/OFF (for VCD 2.0 with PBC feature)</b> Select between PBC On and Off. 'PBC OFF' - the playback will start automatically. 'PBC ON' - the disc menu (if available) will appear on the TV. Use the <b>numeric keypad (0-9)</b> to enter your choice.
	<b>PROGRAM</b> Stop playback, then select this to enter the program menu (see page 25 "Using the menu bar to program".)





# DVD Setup Menu Options

English

## Using the Setup Menu

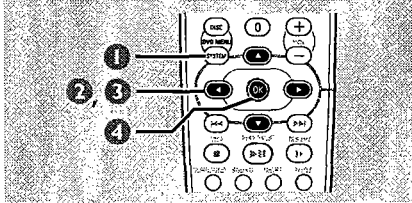
This DVD setup is carried out via the TV, enabling you to customize the DVD system to suit your particular requirements.



- 1 In disc mode, press **SYSTEM MENU**.  
→ Playback will pause.
- 2 Highlight  icon and press ▼ to enter the setup menu. Then press ▲▼ to select one of the setup menu options and press ► to enter the menu.



- 3 Use ◀▶▲▼ keys on the remote to navigate in the menu.
- 4 Press **OK** to confirm your selection.

### NOTE:

Some of the features in the Setup Menu are described in "Getting Started."

## Setting the video output

Choose the type of video output that matches the video connection between the DVD system and your TV.

Stop playback, then follow the steps of "Using the Setup Menu" and select :

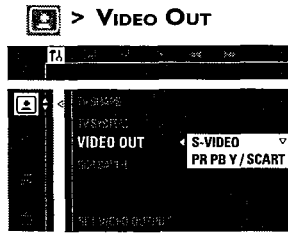

### S-VIDEO

Select this if you have connected the DVD system to your TV using the S-Video jack.

### PR PB Y / SCART

Select this if you have connected the DVD system to your TV using component video jacks. (SCART – this feature is not available for this model.)

### Helpful Hint:

– You do not need to adjust the video output setting if you are using CVBS jack (yellow) to connect the DVD system to your TV.

**TIPS:** To return to the previous menu, press ◀  
To remove the menu, press **SYSTEM MENU**.

# DVD Setup Menu Options

English

## Screen Saver – turning on/off

The screen saver will help to prevent your TV display device from becoming damaged.

Follow the steps of “Using the Setup Menu” and select :

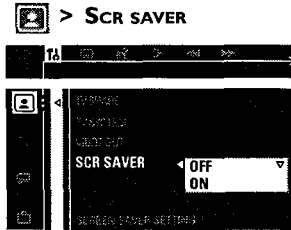

### **OFF**

Select this to disable the screen saver function.

### **ON**

Select this if you wish to turn off the TV screen when play is stopped or paused for more than five (5) minutes.

## Setting the digital output

Set Digital Output according to the optional audio equipment you connected.

Follow the steps of “Using the Setup Menu” and select :

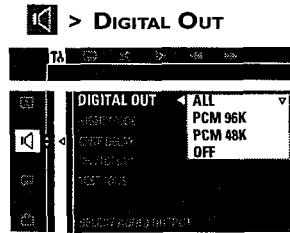

### **ALL**

Select this if you have connected the digital output to an optional piece of audio equipment that has a multichannel decoder.

### **PCM 96 kHz**

Select this if the optional audio equipment is capable of processing digital signal input with sampling rates of 96 kHz. However, if the sound output is distorted or there is no sound, select '48 kHz' instead.

### **PCM 48 kHz**

Select this if the optional audio equipment is incapable of processing 96 kHz digital signal input. The signal will then be converted to a standard signal with sampling rates of 48 kHz.

### **OFF**

Select this to deactivate the digital output.

### *Helpful Hint:*

– Analog signal will also be available through the digital output.

**TIPS:** To return to the previous menu, press **←**  
To remove the menu, press **SYSTEM MENU**

# DVD Setup Menu Options

English

## Night mode – turning on/off

When activated the night mode, the high volume outputs will be softened and low volume outputs will be brought upward to an audible level. It is useful for watching your favorite action movie without disturbing others at night. This function can also be accessed via the NIGHT button on the remote.

Follow the steps of “Using the Setup Menu” and select :

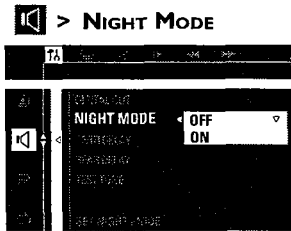

### OFF

Select this when you want to enjoy the full dynamic of surround sound.

### ON

Select this to level out the volume. This feature is only available for movies with Dolby Digital mode.

## Restoring to original settings

Setting the DEFAULT function will reset all options and your personal settings to the factory defaults, except your password for Parental Control.

Follow the steps of “Using the Setup Menu” and select :

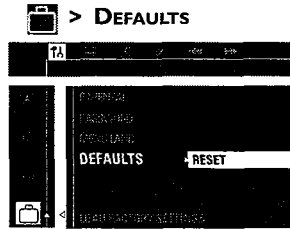

### RESET

Pressing ► to select {RESET}, all settings will now reset to factory defaults.



**TIPS:** To return to the previous menu, press ◀  
To remove the menu, press **SYSTEM MENU**.

# DVD Setup Menu Options

## Restricting playback by Parental Control

(only available in region 1 players)

Some DVDs may have a parental level assigned to the complete disc or to certain scenes on the disc. This feature lets you set a playback limitation level. The rating levels are from 1 to 8 and are country dependent. You can prohibit the playing of certain discs that are not suitable for your children or have certain discs played with alternative scenes.

- 1 In disc mode, press **SYSTEM MENU**.  
→ Use the ◀ ▶ ▲ ▼ keys on the remote to navigate in the menu.
- 2 Select  icon and press ▼.  
Move to  and press ▶.  
Move to {PARENTAL} and press ▶.

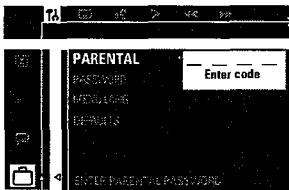

- 3 Use the **numeric keypad (0-9)** to enter '1234' (default password) when you are asked to enter the four-digit password. You will have to enter the same code, exactly, twice.  
→ To change the password, see page 31 "Changing the password."

- 4 Select a rating level and press **OK**.  
→ DVDs that are rated above the level you selected will not play unless you enter your four-digit password and choose a higher level rating. To disable Parental Controls and have all discs play, choose 'NO PARENTAL.'

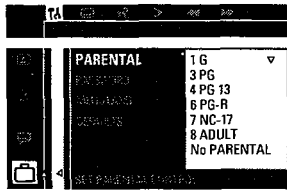

- 5 Press **SYSTEM MENU** again to remove the menu.

## Rating explanations

**NO PARENTAL** – It will play all discs.

- 8 ADULT** – Mature material; should be viewed only by adults due to graphic sexual material, violence, or language.
- 7 NC-17** – No children under age 17; not recommended viewing for children under age 17.
- 6 PG-R** – Parental Guidance - Restricted; recommended that parents restrict children under 17 from viewing or allow to view only when supervised by a parent or adult guardian.
- 4 PG13** – Material is unsuitable for children under age 13.
- 3 PG** – Parental Guidance suggested.
- 1 G** – General Audience; recommended as acceptable for viewers of all ages.

## Helpful Hints:

- VCD, SVCD, CD have no level indication, so parental control has no effect on these type of discs. This also applies to most illegal DVDs.
- Some DVDs are not encoded with a rating though the movie rating may be printed on the Disc cover. The rating level feature does not prohibit play of such Discs.



**TIPS:** To return to the previous menu, press ◀  
To remove the menu, press **SYSTEM MENU**

## DVD Setup Menu Options

English

### Changing the password

You can change the four-digit password used for Parental Control. Enter your four-digit password to play a prohibited disc or if prompted for a password. The default password is '1234.'

- 1 In disc mode, press **SYSTEM MENU**.  
→ Use the ◀▶▲▼ keys on the remote to navigate in the menu.
- 2 Select  icon and press ▼.  
Move to  and press ▶.  
Move to {PASSWORD} and press ▶.

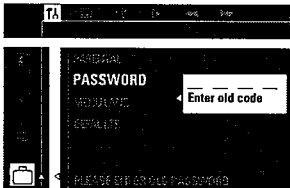

- 3 Use the **numeric keypad (0-9)** to enter your original four-digit password at "Enter old code."  
→ If you are asked to enter the code for the first time, key in '1234.'  
→ If you forget your password, press ■ **four times** to restore to the default password (1234.)

- 4 Enter your new four-digit password.

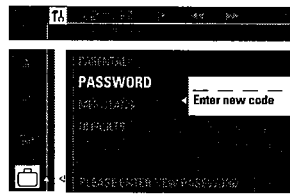

- 5 Enter the same new four-digit password again.

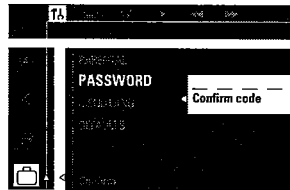

- 6 Press **SYSTEM MENU** again to remove the menu.

**TIPS:** To return to the previous menu, press ◀  
To remove the menu, press **SYSTEM MENU**

## Tuner Operations

### IMPORTANT!

Make sure the FM and AM antennas are connected.

### Tuning to radio stations

- ① Press **TUNER** on the remote (or press **SOURCE** control on front panel) to select "FM" or "AM."
- ② Press and hold **◀◀ / ▶▶** on the remote until the frequency indication starts to change, then release.  
→ The next radio station will tune automatically.
- ③ To tune a weak station, press **◀◀ / ▶▶** briefly and repeatedly until an optimal reception is found.

### Presetting radio stations

You can store up to 40 preset radio stations in the memory, starting from FM and followed by AM bands.

#### Automatic presetting

You can store all available radio stations automatically.

- In tuner mode, press and hold **PROG** until "AUTO PROG" appears.  
→ All the available radio stations with strong transmission signal will be stored.  
→ Automatic preset will begin from preset (1) and all your former presets will be overridden.  
→ If it has reached 40 presets, "PROG FULL" appears.  
→ Once completed, "PROG END" appears.



#### Manual presetting

You can choose to store only your favourite radio stations.

- ① Tune to your desired radio station (see "Tuning to a radio station".)
- ② Press **PROG**.  
→ "PROGRAM" icon appears.
- ③ Use the **numeric keypad (0-9)** to select a preset number.  
→ If "PROGRAM" icon goes off before you select the desired preset number, press **PROG** again.



- ④ Press **PROG** again to store.
- ⑤ Repeat steps ①~④ to store other radio stations.

#### Helpful Hints:

- If you attempt to program more than 40 preset radio stations, "PROG FULL" appears.
- The system will exit presetting mode if no button is pressed within five seconds.

### Selecting a preset radio station

- Press **◀ ▶** or use the **numeric keypad (0-9)** to select a preset number.  
→ The preset number, radio frequency, and waveband will appear.

#### Deleting a preset radio station

- Press and hold **■** until "PXX CLR" appears.  
→ The current preset radio station will be deleted.

## Sound Control

### IMPORTANT!

For proper surround sound, make sure the speakers and subwoofer are connected (see page 11.)

### Selecting surround sound

- Press **SURROUND** to select surround or stereo mode.
  - The availability of the various surround sound modes depends on the number of speakers used and the sound available on the disc.
  - The center and surround speakers operate only in Multi-channel surround mode.
  - The available output modes for multi-channel include: Dolby Digital, Dolby Pro Logic or Dolby Pro Logic II surround sound.
  - Stereo broadcasts or recordings will produce some surround channel effects when played in a surround mode. However, monaural (single channel sound) sources will not produce any sound from the rear speakers.

### Selecting digital sound effects

Select a preset digital sound effects that matches your disc's content or that optimizes the sound of the musical style you are playing.

- Press **SOUND** to select the available sound effect.

When playing movie discs, you can select: CONCERT, DRAMA, ACTION or SCI-FI.

When playing music discs or while in TV, TUNER or AUX mode, you can select: ROCK, DIGITAL, CLASSIC or JAZZ.

#### Helpful Hint:

– For flat sound output, select CONCERT or CLASSIC.

## Volume control

- Adjust **VOLUME** control (or press **VOL +/–** on the remote) to increase or decrease the volume level.
  - "VOL XX" appears. "XX" denotes the volume level.

### To listen through the headphones

- Connect the headphones plug to the **PHONES** socket at the front of the DVD system.
  - The speakers will be mute.

### To turn off the volume temporarily

- Press **MUTE**.
  - Playback will continue without sound and "MUTE" appears.
  - To restore the volume, press MUTE again or increase the volume level.

## Dimming system's display screen

- In any active mode, press **DIM** to select desired brightness : HIGH, MID or LOW.

## Other Functions

### Using the remote to operate 'Philips' television

- 1 Press **TV**.
- 2 Press **◀◀ / ▶▶** or use the **numeric keypad (0-9)** to select the TV's channel.
- 3 Press **TVVOL + / -** to adjust the TV's volume level.
- 4 Press **⏻** to turn off your TV.

#### Helpful Hint:

– When listening to TV or AUX programs, press the respective TV or AUX button on the remote in order for the sound to be heard.

### Setting the Sleep Timer

The sleep timer enables the system to switch to standby mode automatically at a preset time.

- Press **SLEEP** repeatedly until it reaches the desired preset turn-off time.  
→ The selections are as follows (time in minutes):  
15 → 30 → 45 → 60 → 90 → 120  
→ OFF → 15 ...  
→ "SLEEP" icon will show on the display, except if "OFF" is selected.

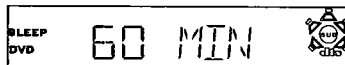

#### To check or change the setting

- Press **SLEEP** once to show the remaining time before switching off. If you continue pressing the **SLEEP** button, the next Sleep Timer option will appear.

#### To cancel the sleep timer

- Press **SLEEP** repeatedly until "OFF" appears or press the **STANDBY ON** button.



# Specifications

English

## AMPLIFIER SECTION

Output power	500 W Total power
- Front	80 W RMS / channel 60 W FTC <sup>Ⓢ</sup> / channel
- Rear	80 W RMS / channel
- Center	80 W RMS
- Subwoofer	100 W RMS
Frequency Response	180 Hz – 14 kHz / ±3 dB
Signal-to-Noise Ratio	> 60 dB (A-weighted)
Input Sensitivity	
- AUX In	400 mV
- TV In	400 mV

<sup>Ⓢ</sup> 4ohm, 120 Hz~12.5 kHz, 10% THD

## TUNER SECTION

Tuning Range	FM 87.5 – 108 MHz (100 kHz steps) AM 530 – 1710 kHz (10 kHz steps)
26 dB Quieting Sensitivity	FM 20 dBf
26 dB Quieting Sensitivity	AM 5000 μV/m
Image Rejection Radio	FM 25 dB AM 28 dB
IF Rejection Ratio	FM 60 dB AM 24 dB
Signal-to-Noise Ratio	FM 55 dB AM 40 dB
AM Suppression Ratio	FM 30 dB
Harmonic Distortion	FM Mono 3% FM Stereo 3% AM 5%
Frequency Response	FM 180 Hz – 10 kHz / ±6 dB
Stereo Separation	FM 26 dB (1 kHz)
Stereo Threshold	FM 23.5 dB

## DISC SECTION

Laser Type	Semiconductor
Disc Diameter	12cm / 8cm
Video Decoding	MPEG-2 / MPEG-1
Video DAC	10 Bits
Signal System	PAL / NTSC
Video Format	4:3 / 16:9
Video S/N	56 dB (minimum)
Composite Video Output	1.0 Vp-p, 75 Ω
S-Video Output	Y - 1.0 Vp-p, 75 Ω C - 0.286 Vp-p, 75 Ω
Audio DAC	24 Bits / 96 kHz
Frequency Response	4 Hz – 20 kHz (44.1 kHz) 4 Hz – 22 kHz (48 kHz) 4 Hz – 44 kHz (96 kHz)
Digital Output	SPDIF (Sony Philips digital interface) Coaxial
- PCM	IEC 60958
- Dolby Digital	IEC 60958, IEC 61937

## MAIN UNIT

Power Supply Rating	120 V / 60 Hz
Power Consumption	160 W
Dimensions (w x h x d)	435 x 48 x 350 (mm) 17.13 x 1.89 x 13.78 (inch)
Weight	4.35 kg / 9.57 pounds

## SPEAKERS

Front/Rear speakers	
System	2 ways, Bass Reflex system
Impedance	4 Ω
Speaker drivers	3" woofer, 1 3/4" piezo
Frequency response	120 Hz – 20 kHz
Dimensions (w x h x d)	90 x 230 x 80 (mm) 3.54 x 9.06 x 3.15 (inch)
Weight	0.835 kg/1.837 pounds

## CENTER SPEAKER

System	5 multi directional driver
Impedance	4 Ω
Speaker drivers	4 x 3" woofer, 1 3/4" piezo
Frequency response	120 Hz – 20 kHz
Dimensions (w x h x d)	435 x 72 x 64 (mm) 17.13 x 2.83 x 2.52 (inch)
Weight	1.25 kg/2.75 pounds

## SUBWOOFER

Impedance	3 Ω
Speaker drivers	6 1/2" woofer
Frequency response	30 Hz – 120 Hz
Dimensions (w x h x d)	300 x 300 x 300 (mm) 11.81 x 11.81 x 11.81 (inch)
Weight	4.5 kg/9.9 pounds

Specifications subject to change without prior notice

# Troubleshooting

## WARNING

Under no circumstances should you try to repair the system yourself, as this will invalidate the warranty. Do not open the system as there is a risk of electric shock.

If a fault occurs, first check the points listed below before taking the system for repair. If you are unable to remedy a problem by following these hints, please call [1-800-531-0039](tel:1-800-531-0039) for help.

Problem	Solution
No power.	<ul style="list-style-type: none"><li>- Check if the AC power cord is properly connected.</li><li>- Press the STANDBY ON on the front of the DVD system to turn on the power.</li></ul>
No picture.	<ul style="list-style-type: none"><li>- Refer to your TV's manual for correct Video In channel selection. Change the TV channel until you see the DVD screen. (see page 18)</li><li>- Press DISC on the remote.</li><li>- Switch the P-SCAN at the back panel to "OFF" position if you are not using a Progressive Scan TV.</li></ul>
Completely distorted picture or black/white picture.	<ul style="list-style-type: none"><li>- If this happens when you changing the setting of the 'TV SYSTEM', wait for 15 seconds for auto recovery. (see page 19)</li><li>- Check the video connection. (see pages 12-13)</li><li>- Sometimes a small amount of picture distortion may appear. This is not a malfunction.</li><li>- Clean the disc. (see page 10)</li></ul>
The aspect ratio of the screen cannot be changed even though you have set the TV display.	<ul style="list-style-type: none"><li>- The aspect ratio is fixed on the DVD disc.</li><li>- Depending on the TV, it may not be possible to change the aspect ratio.</li></ul>
No sound or distorted sound.	<ul style="list-style-type: none"><li>- Adjust the volume.</li><li>- Check the speaker connections and settings. (see pages 11, 20)</li><li>- Disconnect the headphones.</li><li>- Press the correct source button on the remote (TV or AUX, for example) to choose the equipment that you want to hear through the DVD system. (see pages 12, 13, 15)</li></ul>
The DVD system does not work.	<ul style="list-style-type: none"><li>- Disconnect the power cord from the power outlet for a few minutes. Reconnect the power cord and try to operate again as usual.</li></ul>
The disc tray cannot open and "TRAY LOCKED" is displayed.	<ul style="list-style-type: none"><li>- Press and hold SOURCE button on the front panel for more than two seconds, then press PLAY button.</li></ul>

Problem	Solution
<p><b>The DVD player does not start playback.</b></p>	<ul style="list-style-type: none"> <li>- Insert a readable disc with the playback side facing down. The DVD+R/CD-R must be finalized. (see page 22)</li> <li>- Check the disc type, color system and region code. (see page 22)</li> <li>- Check for any scratches or smudges on the disc.</li> <li>- Press SYSTEM SETUP to turn off the setup menu screen.</li> <li>- You may need to enter the password in order to change the parental control rating level or to unlock the disc for playback. (see page 30)</li> <li>- Moisture has condensed inside the system. Remove the disc and leave the system turned on for about an hour.</li> </ul>
<p><b>Cannot activate some features, such as Angles, Subtitles, or multi-language Audio.</b></p>	<ul style="list-style-type: none"> <li>- The features may not be available on the DVD.</li> <li>- Changing the language for the sound or subtitle is prohibited on the DVD.</li> </ul>
<p><b>There is no sound from the center and rear speakers.</b></p>	<ul style="list-style-type: none"> <li>- Press CENTER + - or REAR + - to adjust the volume level. (see page 20)</li> <li>- Make sure the center and rear speakers are connected correctly. (see page 11)</li> <li>- Press SURROUND button to select a correct surround sound setting. (see page 33)</li> <li>- Make sure the source you are playing is recorded or broadcast in surround sound (DPL II, Dolby Digital, etc.)</li> </ul>
<p><b>Radio reception is poor.</b></p>	<ul style="list-style-type: none"> <li>- If the signal is too weak, adjust the antenna or connect an external antenna for better reception.</li> <li>- Increase the distance between the system and your TV or VCR.</li> <li>- Tune in to the correct frequency.</li> <li>- Place the antenna farther away from any equipment that may be causing the noise.</li> </ul>
<p><b>The remote control does not function properly.</b></p>	<ul style="list-style-type: none"> <li>- Select the source (DISC or TUNER, for example) before pressing the function button (▶    ◀◀ ▶▶).</li> <li>- Reduce the distance between the remote control and the system.</li> <li>- Replace the batteries with new ones.</li> <li>- Point the remote control directly toward the IR sensor.</li> <li>- Check that the batteries are loaded correctly.</li> </ul>
<p><b>The display panel is dark.</b></p>	<ul style="list-style-type: none"> <li>- Press DIM again. (see page 33)</li> </ul>
<p><b>Low hum or buzz sound.</b></p>	<ul style="list-style-type: none"> <li>- Place the DVD system as far away as possible from electrical devices that may be causing interference.</li> </ul>

**Analog:** Sound that has not been turned into numbers. Analog sound varies, while digital sound has specific numerical values. These jacks send audio through two channels, the left and right.

**Aspect ratio:** The ratio of vertical and horizontal sizes of a displayed image. The horizontal vs. vertical ratio of conventional TVs. is 4:3, and that of wide-screens is 16:9.

**AUDIO OUT Jacks:** Jacks on the back of the DVD System that send audio to another system (TV, Stereo, etc.)

**Bit Rate:** The amount of data used to hold a given length of music; measured in kilobits per second, or kbps. Or, the speed at which you record. Generally, the higher the bit rate, or the higher the recording speed, the better the sound quality. However, higher bit rates use more space on a Disc.

**Chapter:** Sections of a picture or a music piece on a DVD that are smaller than titles. A title is composed of several chapters. Each chapter is assigned a chapter number enabling you to locate the chapter you want.

**Component Video Out Jacks:** Jacks on the back of the DVD System that send high-quality video to a TV that has Component Video In jacks (R/G/B, Y/Pb/Pr, etc.)

**Disc menu:** A screen display prepared for allowing selection of images, sounds, subtitles, multi-angles, etc recorded on a DVD.

**Digital:** Sound that has been converted into numerical values. Digital sound is available when you use the DIGITAL AUDIO OUT COAXIAL or OPTICAL jacks. These jacks send audio through multiple channels, instead of just two channels as analog does.

**Dolby Digital:** A surround sound system developed by Dolby Laboratories containing up to six channels of digital audio (front left and right, surround left and right, center and subwoofer.)

**Dolby Pro Logic II:** It creates five full-bandwidth output channels from two-channel sources. Decode only systems that derive 5.1 channels instead of the conventional 4 channels of Dolby Pro Logic surround sound.

**JPEG:** A very common digital still picture format. A still-picture data compression system proposed by the Joint Photographic Expert Group, which features small decrease in image quality in spite of its high compression ratio.

**MP3:** A file format with a sound data compression system. "MP3" is the abbreviation of Motion Picture Experts Group 1 (or MPEG-1) Audio Layer 3. By using the MP3 format. One CD-R or CD-RW can contain about 10 times more data than a regular CD.

**Parental control:** Limits Disc play according to the age of the users or the limitation level in each country. The limitation varies from disc to disc; when it is activated, playback will be prohibited if the software's level is higher than the user-set level.

**PCM (Pulse Code Modulation):** A system for converting analog sound signal to digital signal for later processing, with no data compression used in conversion.

**Playback control (PBC):** Refers to the signal recorded on video CDs or SVCDs for controlling playback. By using menu screens recorded on a Video CD or SVCD that supports PBC, you can enjoy interactive playback and searching.

**Progressive Scan:** It displays all the horizontal lines of a picture at one time, as a single frame.

This system can convert the interlaced video from DVD into progressive format when the DVD Player is connected to a Progressive Scan TV. It dramatically increases the vertical resolution and provides the best picture.

**Region code:** A system allowing discs to be played only in the region designated. This unit will only play discs that have compatible region codes. You can find the region code of your unit by looking on the product label. Some discs are compatible with more than one region (or ALL regions.)

**S-Video:** Produces a clear picture by sending separate signals for the luminance and the color. You can use S-Video only if your TV has an S-Video In jack.

**Sampling Frequency:** Frequency of sampling data when analog data is converted to digital data. Sampling frequency numerically represents how many times the original analog signal is sampled per second.

**Surround:** A system for creating realistic three-dimensional sound fields full of realism by arranging multiple speakers around the listener.

**Title:** The longest section of a movie or music feature on DVD. Each title is assigned a title number, enabling you to locate the title you want.

**VIDEO OUT jack:** Yellow jack on the back of the DVD system that sends the DVD picture video to a TV.

# LIMITED WARRANTY

## AUDIO SYSTEM

One Year Free Labor

One Year Free Service on Parts

This product must be carried in for repair.

### **WHO IS COVERED?**

You must have proof of purchase to receive warranty service. A sales receipt or other document showing that you purchased the product is considered proof of purchase.

### **WHAT IS COVERED?**

Warranty coverage begins the day you buy your product. For one year thereafter, all parts will be repaired or replaced, and labor is free. After one year from the day of purchase, you pay for the replacement or repair of all parts, and for all labor charges.

All parts, including repaired and replaced parts, are covered only for the original warranty period. When the warranty on the product expires, the warranty on all replaced and repaired parts also expires.

### **WHAT IS EXCLUDED?**

Your warranty does not cover:

- labor charges for installation or setup of the product, adjustment of customer controls on the product, and installation or repair of antenna systems outside of the product.
- product repair and/or part replacement because of misuse, accident, unauthorized repair or other cause not within the control of Philips.
- reception problems caused by signal conditions or cable or antenna systems outside the unit.
- a product that requires modification or adaptation to enable it to operate in any country other than the country for which it was designed, manufactured, approved and/or authorized, or repair of products damaged by these modifications.
- incidental or consequential damages resulting from the product. (Some states do not allow the exclusion of incidental or consequential damages, so the above exclusion may not apply to you. This includes, but is not limited to, prerecorded material, whether copyrighted or not copyrighted.)
- a product that is used for commercial or institutional purposes.

### **WHERE IS SERVICE AVAILABLE?**

Warranty service is available in all countries where the product is officially distributed by Philips. In countries where Philips does not distribute the product, the local Philips service organization will attempt to provide service (although there may be a delay if the appropriate spare parts and technical manual(s) are not readily available).

### **MAKE SURE YOU KEEP..**

Please keep your sales receipt or other document showing proof of purchase. Attach it to this owner's manual and keep both nearby. Also keep the original box and packing material in case you need to return your product.

### **BEFORE REQUESTING SERVICE...**

Please check your owner's manual for assistance. If you have additional questions, call us at 1-800-531-0039.

### **TO GET WARRANTY SERVICE IN U.S.A., PUERTO RICO, OR U.S. VIRGIN ISLANDS...**

Take the product to a Philips factory service center (see enclosed list) or authorized service center for repair. When the product has been repaired, you must pick up the unit at the center. Centers may keep defective parts.

(In U.S.A., Puerto Rico, and U.S. Virgin Islands, all implied warranties, including implied warranties of merchantability and fitness for a particular purpose, are limited in duration to the duration of this express warranty. But, because some states do not allow limitations on how long an implied warranty may last, this limitation may not apply to you.)

### **TO GET WARRANTY SERVICE IN CANADA...**

Please contact Philips at:

1-800-661-6162 (French Speaking)

1-800-531-0039 (English or Spanish Speaking)

(In Canada, this warranty is given in lieu of all other warranties. No other warranties are expressed or implied, including any implied warranties of merchantability or fitness for a particular purpose. Philips is not liable under any circumstances for any direct, indirect, special, incidental or consequential damages, howsoever incurred, even if notified of the possibility of such damages.)

### **REMEMBER...**

Please record below the model and serial numbers found on the product. Also, please fill out and mail your warranty registration card promptly. It will be easier for us to notify you if necessary.

MODEL # \_\_\_\_\_

SERIAL # \_\_\_\_\_

*This warranty gives you specific legal rights. You may have other rights which vary from state/province to state/province.*

**Philips, P.O. Box 520890, Miami, FL 33152, USA, (402) 536-4171**

EL4965E007 / 8-02