

# Always there to help you

Register your product and get support at  
[www.philips.com/support](http://www.philips.com/support)



NTRX700



## User manual

**PHILIPS**



# Contents

<b>1 Important</b>	2
Know these safety symbols	2
<b>2 Your Mini Hi-Fi System</b>	4
Introduction	4
What's in the box	4
Overview of the main unit	5
Overview of the remote control	6
<b>3 Connect</b>	8
Connect FM antenna	8
Connect AM antenna	8
Connect speakers	8
Connect LED wires of speakers	9
Connect power	9
<b>4 Get started</b>	10
Prepare the remote control	10
Turn on	10
<b>5 Play</b>	11
Play from a disc or USB	11
Play audio through Bluetooth	13
Listen to an external device	14
<b>6 Listen to radio</b>	15
Tune to a radio station	15
Program radio stations automatically	15
Program radio stations manually	15
Select a preset radio station	15
Change AM tuning grid	15
<b>7 Adjust volume level and sound effect</b>	16
Adjust volume level	16
Mute sound	16
Apply AUTO DJ effect	16
Apply DJ effects manually	16
Select a preset sound effect	16
Enhance bass	16
Apply NX Bass	17
Adjust equalizer settings	17
<b>8 Other features</b>	18
Mix sound	18
Speak or sing with a microphone	18
Turn the decorative light on or off	18
<b>9 Product information</b>	19
Specifications	19
USB playability information	19
Supported MP3 disc formats	20
Maintenance	20
<b>10 Troubleshooting</b>	21
About Bluetooth device	21
<b>11 Notice</b>	22

# 1 Important

## Know these safety symbols



This 'bolt of lightning' indicates uninsulated material within your unit may cause an electrical shock. For the safety of everyone in your household, please do not remove product covering.

The 'exclamation point' calls attention to features for which you should read the enclosed literature closely to prevent operating and maintenance problems.

**WARNING:** To reduce the risk of fire or electric shock, this apparatus should not be exposed to rain or moisture and objects filled with liquids, such as vases, should not be placed on this apparatus.

**CAUTION:** To prevent electric shock, match wide blade of plug to wide slot, fully insert.

### Warning

- Never remove the casing of this device.
- Never lubricate any part of this device.
- Never place this device on other electrical equipment.
- Keep this device away from direct sunlight, naked flames or heat.
- Never look into the laser beam inside this device.
- Ensure that you always have easy access to the power cord, plug, or adaptor to disconnect this device from the power.

- Do not use this apparatus near water.
- Install in accordance with the manufacturer's instructions.
- Do not install near any heat sources such as radiators, heat registers, stoves, or other apparatus (including amplifiers) that produce heat.

- Protect the power cord from being walked on or pinched, particularly at plugs, convenience receptacles, and the point where they exit from the apparatus.
- Only use attachments/accessories specified by the manufacturer.
- Use only with the cart, stand, tripod, bracket, or table specified by the manufacturer or sold with the apparatus. When a cart is used, use caution when moving the cart/apparatus combination to avoid injury from tip-over.



- Unplug this apparatus during lightning storms or when unused for long periods of time.
- Refer all servicing to qualified service personnel. Servicing is required when the apparatus has been damaged in any way, such as power-supply cord or plug is damaged, liquid has been spilled or objects have fallen into the apparatus, the apparatus has been exposed to rain or moisture, does not operate normally, or has been dropped.
- Battery usage CAUTION – To prevent battery leakage which may result in bodily injury, property damage, or damage to the unit:
  - Install all batteries correctly, + and - as marked on the unit.
  - Do not mix batteries (old and new or carbon and alkaline, etc.).
  - Remove batteries when the unit is not used for a long time.
- Batteries (battery pack or batteries installed) shall not be exposed to excessive heat such as sunshine, fire or the like.
- Apparatus shall not be exposed to dripping or splashing.

- Do not place any sources of danger on the apparatus (e.g. liquid filled objects, lighted candles).
- Where the MAINS plug or an appliance coupler is used as the disconnect device, the disconnect device shall remain readily operable.



### Caution

- Use of controls or adjustments or performance of procedures other than herein may result in hazardous radiation exposure or other unsafe operation.

## 2 Your Mini Hi-Fi System

Congratulations on your purchase, and welcome to Philips! To fully benefit from the support that Philips offers, register your product at [www.Philips.com/welcome](http://www.Philips.com/welcome).

---

### Introduction

#### With this unit, you can

- enjoy audio from discs, USB storage devices, Bluetooth enabled devices, or other external devices;
- swap play between the dual audio sources with the cross fader;
- listen to FM or AM radio stations;
- speak or sing with microphones through the loudspeakers of the unit; and
- record to a USB storage device.

#### To enrich sound, this unit offers you these sound effects:

- Digital Sound Control (DSC)
- Dynamic Bass Boost (DBB)
- DJ effects
- NX Bass Enhancement

---

### What's in the box

Check and identify the contents of your package:

- Main unit x 1
- Speaker x 1
- Remote control with 2 AAA batteries
- FM wire antenna x 1
- AM loop antenna x 1
- Short user manual

## Overview of the main unit

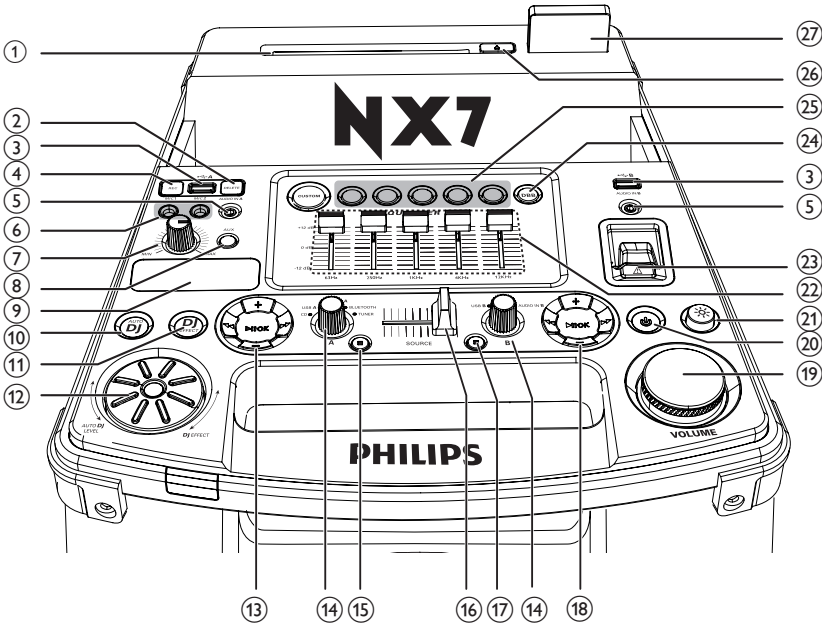

- |   |  |
|---|--|
| <p>① Disc slot</p> <p>② DELETE</p> <ul style="list-style-type: none"> <li>In USB A mode, delete audio files stored on a USB device.</li> </ul> <p>③ ↔ A/B</p> <ul style="list-style-type: none"> <li>Connect USB mass storage devices.</li> </ul> <p>④ REC</p> <ul style="list-style-type: none"> <li>In USB A mode, record to a USB device.</li> </ul> <p>⑤ AUDIO IN A/B</p> <ul style="list-style-type: none"> <li>Connect an external audio device.</li> </ul> <p>⑥ MIC 1/2 (Microphone ports)</p> <ul style="list-style-type: none"> <li>Connect a microphone.</li> </ul> <p>⑦ MIC volume knob</p> <ul style="list-style-type: none"> <li>Adjust microphone volume.</li> </ul> <p>⑧ AUX</p> <ul style="list-style-type: none"> <li>Select an audio source from an external device: DVD, PC, TV or GAME player.</li> </ul> | <p>⑨ Display panel</p> <ul style="list-style-type: none"> <li>Show status.</li> </ul> <p>⑩ AUTO DJ</p> <ul style="list-style-type: none"> <li>In USB A mode, apply AUTO DJ effect automatically.</li> </ul> <p>⑪ DJ EFFECT</p> <ul style="list-style-type: none"> <li>In CD, USB A, Bluetooth, Tuner, or Audio in A mode, apply DJ effects manually.</li> </ul> <p>⑫ DJ EFFECT dial</p> <ul style="list-style-type: none"> <li>Adjust DJ effect level and AUTO DJ effect level.</li> </ul> <p>⑬ Control play panel (left)</p> <ul style="list-style-type: none"> <li>Control play for <b>Source A</b> modes (including Disc, USB A, Bluetooth, and Tuner modes).</li> </ul> <p>⑭ Source selector</p> <ul style="list-style-type: none"> <li>Select an audio source.</li> </ul> |
|---|--|

- 15 ■ (Left)
- In Disc or USB A mode, stop play or erase programmed list.
  - Exit the recording process.
  - In Tuner mode, switch between FM and AM bands.

- 16 CROSS FADER
- Adjust the left/right channel balance during playback.

- 17 ■ (Right)
- In USB B mode, stop play.

- 18 Control play panel (right)
- Control play for USB B mode.

- 19 Volume knob
- Adjust volume.

- 20 
- Turn on the unit or switch to standby mode.

- 21 
- Enable or disable the speaker lighting effect.

- 22 Custom Equalizer
- In CUSTOM mode, adjust the equalizer settings for each of the five frequency ranges by moving the slider bars.

- 23 NX Bass button
- Turn NX Bass effect on or off.

- 24 DBB
- Turn dynamic bass enhancement on or off.



- 25 Sound effect keys
- Select a preset sound equalizer setting.

- 26 
- Eject the disc.

- 27 Bluetooth indicator

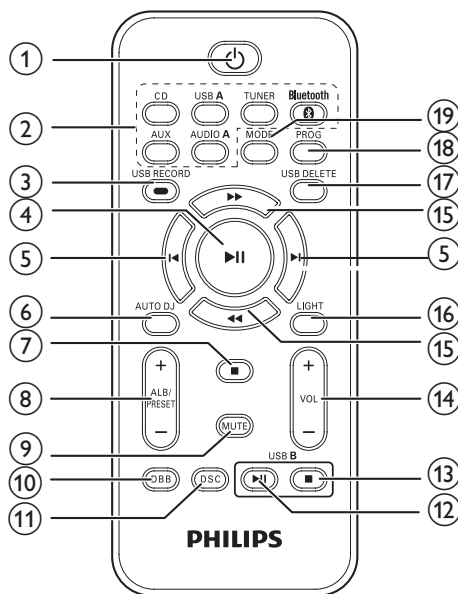
## Overview of the remote control



- 1 
- Turn on the unit or switch to standby mode.
- 2 Source selection keys
- Select a source.
- 3 USB RECORD
- Record to a USB device.
- 4 
- In Disc, USB A, or Bluetooth mode, start or pause play.
- 5 
- In Disc, USB A, or Bluetooth mode, skip to the previous or next track.
- 6 AUTO DJ
- In USB A mode, apply AUTO DJ effect automatically.
- 7 ■
- In Disc or USB A mode, stop playing.
  - Exit the recording process.



- ⑧ **ALB/PRESET +/-**
  - In Disc or USB A mode, skip to the previous or next album.
  - In Tuner mode, select a preset radio station.
- ⑨ **MUTE**
  - Mute or unmute volume.
- ⑩ **DBB**
  - Turn dynamic bass enhancement on or off.
- ⑪ **DSC**
  - Select a preset sound equalizer setting.
- ⑫ **USB B ►||**
  - In USB B mode, start or pause play.
- ⑬ **USB B ■**
  - In USB B mode, stop play.
- ⑭ **VOL +/-**
  - Adjust volume.
- ⑮ **◀◀ / ▶▶**
  - Adjust radio frequency.
  - In Disc or USB A mode, search within a track.
- ⑯ **LIGHT**
  - Enable or diable the speaker lighting effect.
- ⑰ **USB DELETE**
  - In USB A mode, delete audio files stored on a USB storage device.
- ⑱ **PROG**
  - Program tracks.
  - Program radio stations.
- ⑲ **MODE**
  - In Disc or USB A mode, select a play mode.

# 3 Connect

## Connect FM antenna

Connect the supplied FM antenna to the **FM** jack on the back of the main unit.

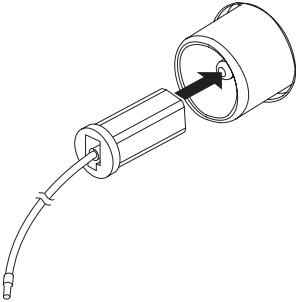

## Connect AM antenna

### Note

- For better reception, adjust the position of the AM antenna.

1 Assemble the AM loop antenna.

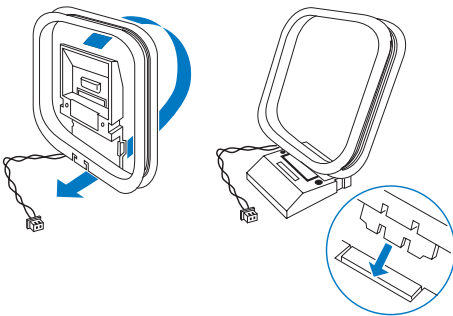

2 Connect the AM loop antenna to the **AM** jack on the back of the main unit.

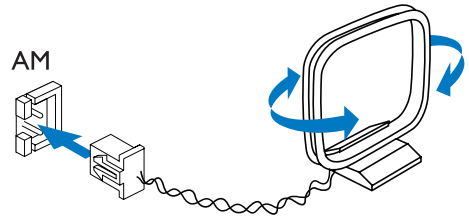

## Connect speakers

### Note

- For optimal sound, use the supplied speakers only.
- Connect only speakers with impedance that is the same or higher than the supplied speakers. Refer to the Specifications section of this manual.

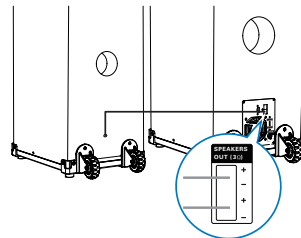

### Connect the speakers

Insert the speaker wires completely into the **SPEAKER OUT** sockets.

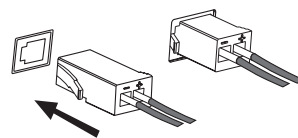

Merely illustrative image

## Connect LED wires of speakers

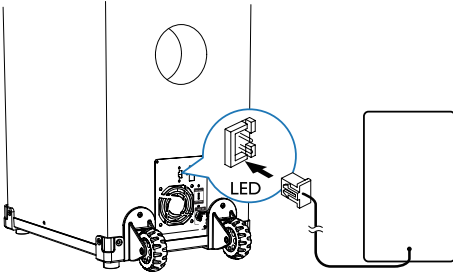

Merely illustrative image

- 1 Find an LED socket on the back of the main unit.
- 2 Insert the connector of the LED wire into the LED socket.

## Connect power

### ! Caution

- Risk of product damage! Make sure that you have selected the power supply voltage that corresponds to your local power supply.
- Risk of electric shock! When you unplug the power cord, always pull the plug from the socket. Never pull the cord.

### ≡ Note

- Before connecting to AC power, make sure that you have completed all other connections.

- 1 Adjust the voltage selector on the back of the main unit to match your local power supply.
- 2 Connect the AC power plug to the power outlet.

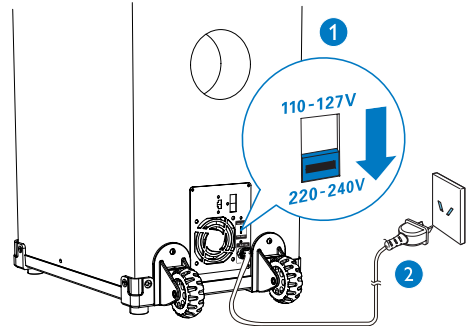

### ✦ Tip

- When you are not using or are transporting the unit, to keep the power cord organized and above the ground, fix the power cable with the cable tie on the back panel of the main unit.

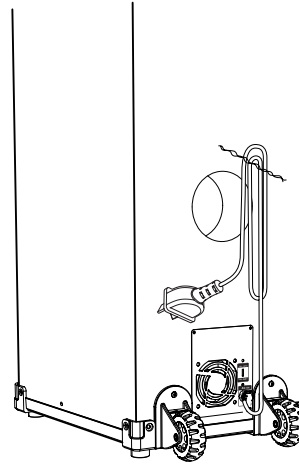

## 4 Get started



### Caution

- Use of controls or adjustments or performance of procedures other than herein may result in hazardous radiation exposure or other unsafe operation.

Always follow the instructions in this chapter in sequence.

If you contact Philips, you will be asked for the model and serial number of this apparatus. The model number and serial number are on the back of the apparatus. Write the numbers here:

Model No. \_\_\_\_\_

Serial No. \_\_\_\_\_

## Prepare the remote control



### Note

- Batteries contain chemical substances, so they should be disposed of properly.

- 1 Open the battery compartment.
- 2 Insert two AAA batteries with correct polarity (+/-) as indicated.
- 3 Close the battery compartment.

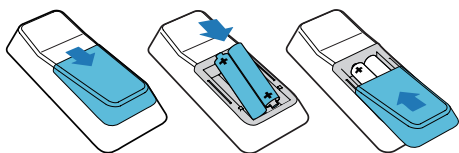

---

## Turn on

Press  $\phi$ .

- ↳ The unit switches to the last selected source.

---

## Switch to standby mode

Press  $\phi$  again to switch the unit to standby mode.

# 5 Play

## Play from a disc or USB

### Play disc

#### Note

- Make sure that the disc contains playable audio contents.

- 1 Press **CD** to select the disc source.
- 2 Slide **CROSS FADER** to the far left.
- 3 Press **▲** on the main unit to eject the disc slot.
- 4 Insert a disc into the disc slot, with the printed side facing up.

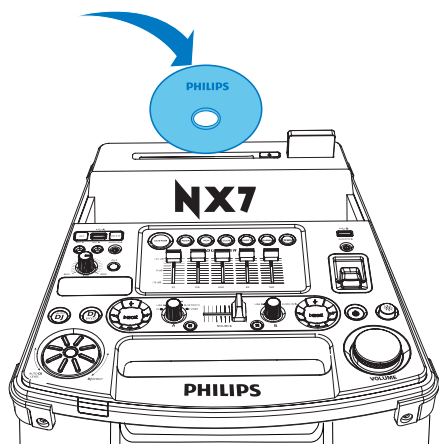

- 5 Press **▶||** to start play.
  - To pause or resume play, press **▶||**.
  - To stop play, press **■** (left).
  - To select another track, press **◀** or **▶**.
  - To select an album, press **ALB/PRESET +/-**.

- To search within a track, press and hold **◀◀** / **▶▶**, then release to resume normal play.

### Play from a USB A device

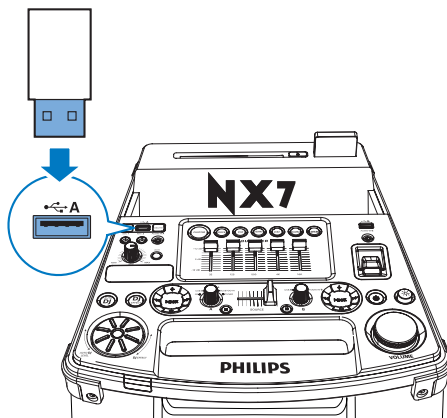

#### Note

- Make sure that the USB device contains playable audio contents in supported formats.

- 1 Insert the USB plug of the device into the **USB A** socket.
- 2 Press **USB A** to select the USB A source.
- 3 Slide the **CROSS FADER** to its far left.
- 4 Press **ALB/PRESET +/-** to select an album.
- 5 Press **◀** or **▶** to select an audio file.
- 6 Press **▶||** to start play.
  - To pause or resume play, press **▶||**.
  - To stop play, press **■** (left).
  - To search within an audio file, press and hold **◀◀** or **▶▶**, then release to resume normal play.

### Delete from a USB device

- 1 In **USB A** mode, press **■** to stop music playback.
- 2 Press **ALB/PRESET +/-** to select an audio folder.
- 3 Press **◀** or **▶** to select an audio file.

- 4 Press **USB DELETE** repeatedly to select:
  - **[DEL FILE]** (Delete file): Delete current audio file.
  - **[DEL DIR]** (Delete directory): Delete current audio folder.
  - **[FORMAT]** (Format): Delete all files in the USB device..
- 5 Press **▶||** to confirm the selection.
  - ↳ A confirmation message is displayed.
  - To cancel, press **■**.

- Ⓐ **[REC ONE]** (record one): the first or current track is recorded.
- Ⓑ **[REC ALL]** (record all): all tracks or the remaining tracks are recorded.
  - ↳ Play starts automatically from the beginning of the disc or the selected track, and the recording starts.
- To stop recording, press **■**.

#### Note

- The function is not available in USB B mode.

#### Caution

- If **[FORMAT]** is selected, all files (including non-audio files) stored in the USB device will be erased.

#### Note

- If the USB device does not have enough memory to store the audio files, a "Full memory" message is displayed.
- This function is not available in USB B and Mix sound mode.
- This function is not available when **AUTO DJ** or **DJ EFFECT** effects are applied.

## Record to a USB device

MP3 files, radio, and audio from external devices are recorded in .mp3 format.

The first time you record to a USB device, a folder is automatically created on the USB device. Each time you record to a USB device, the recorded files are stored in a subfolder of this folder. Files and subfolders are named numerically in the order in which they are created.

- 1 Connect a USB device to **↔ B** socket.
- 2 Prepare the source to record from.
  - Disc: Select the CD source and load a disc, then select a track to start recording.
  - Radio: Tune to a radio station.
  - AUDIO IN: Select the Audio-in source, then connect and play from an external device.
  - USB B: Select **USB B** source, then connect and select an audio file to play.
- 3 Press **USB RECORD** to start recording.
  - For Disc mode, press **USB RECORD** repeatedly to select:

## Play from a USB B device

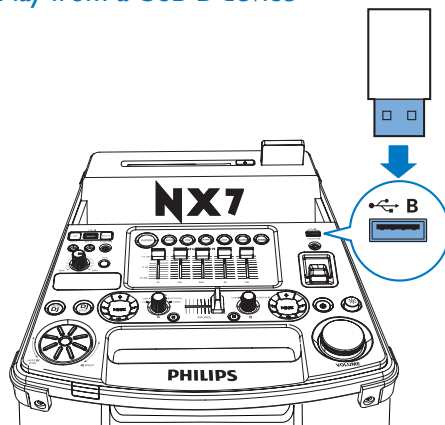

- 1 Insert the USB plug of the device into the **↔ B** socket.
- 2 Rotate the source selector to select the **USB B** source.
- 3 Slide the **CROSS FADER** to its far right.
- 4 Use the control play panel (right) on the top of the main unit to control play.
  - To start, pause, or resume play, press **▶||**.
  - Press **+/-** to select an album.

- To select an audio file, press ◀◀ or ▶▶.
- To stop play, press ■ (right).
- To search within an audio file, press and hold ◀◀ or ▶▶, then release to resume normal play.

## Play options

### Repeat and random play

- 1 In Disc or USB A mode, press **MODE** repeatedly to select:
  - **[REP ONE]** (Repeat one): Play the current track repeatedly.
  - **[REP ALL]** (Repeat all): Play all tracks repeatedly.
  - **[RANDOM]** (Random): Play all tracks randomly.
- 2 To return to normal play, press **MODE** repeatedly to select **[OFF]** (off).

#### Note

- Random play cannot be selected when you play the programmed tracks.

### Program tracks

You can program a maximum of 40 tracks.

- 1 In Disc or USB A mode, press ■ to stop playing.
- 2 Press **PROG** to activate the program mode.
  - ↳ A number flashes on the screen.
- 3 For MP3 tracks, press **ALB/PRESET+/-** to select an album.
- 4 Press ◀ or ▶ to select a track number; then press **PROG** to confirm selection.
- 5 Repeat steps 3 to 4 to program other tracks.
- 6 Press ▶|| to play the programmed track.
  - To erase the program, press ■ twice.

#### Note

- The function is not available in **USB B** mode.

## Play audio through Bluetooth

The unit uses Bluetooth wireless technology to stream music from your Bluetooth device to the system.

#### Note

- Make sure that your Bluetooth device is compatible with this product.
- Before pairing a device with this unit, read its user manual for Bluetooth compatibility.
- The effective operation range between the unit and a Bluetooth device is approximately 10 meters (30 feet).
- The unit can memorize a maximum of 8 paired devices.
- Any obstacle between the unit and a Bluetooth device can reduce the operational range.
- Keep away from any other electronic device that may cause interference.

- 1 Slide **CROSS FADER** to the far left.
  - 2 Press **Bluetooth** to turn on the Bluetooth function of the unit.
    - ↳ The Bluetooth indicator blinks.
  - 3 On your Bluetooth device, enable Bluetooth and search for Bluetooth devices (refer to the user manual of the device).
  - 4 Select **[PHILIPS NTRX700]** (Philips NTRX700) displayed on your device for pairing. If necessary, enter default password "0000".
    - ↳ After successful pairing and connection, the LED indicator turns solid blue.
  - 5 Play audio on your device.
    - ↳ Audio streams from your device to the unit.
      - To start, pause, or resume play, press ▶||.
      - To select another track, press ◀ or ▶.
- To disconnect the Bluetooth-enabled device:**
- Disable Bluetooth on your device; or
  - Move the device beyond the communication range.
- To connect another Bluetooth-enabled device:**
- Disable Bluetooth on the current device, and then connect another device.

---

## Listen to an external device

You can listen to an external audio device through the speakers of this unit.

---

### Play from an MP3 player

- 1 Press **AUDIO A** to select the MP3 link source.
- 2 Slide **CROSS FADER** to the far left.
- 3 Connect an audio input cable (not supplied) with a 3.5 mm connector on both ends to:
  - the **AUDIO IN A** socket on the unit, and
  - the headphone socket on the MP3 player.
- 4 Play audio on the MP3 player (refer to its user manual).

#### Tip

- If the MP3 player is connected to the **AUDIO IN B** socket, rotate the source selector on the main unit to select the Audio In B source.

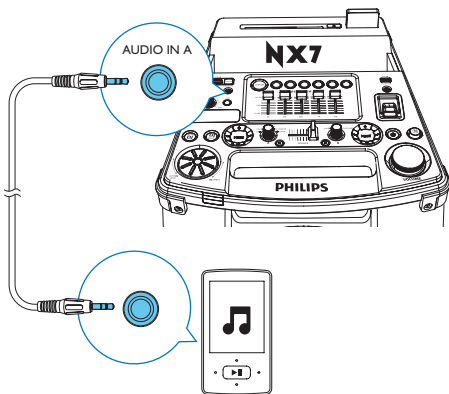

---

### Play from other audio device

You can connect a PC or other audio devices to this unit.

- 1 Press **AUX** repeatedly to cycle through **GAME, PC-IN, TV** and **DVD** sources.
- 2 Connect the white and red audio cables (not supplied) to:
  - the **AUX** sockets on the back of the main unit.
  - the headphone socket on a PC, or the **AUDIO OUT** socket on an external device.
- 3 Play audio on the device (refer to the user manual of the device).

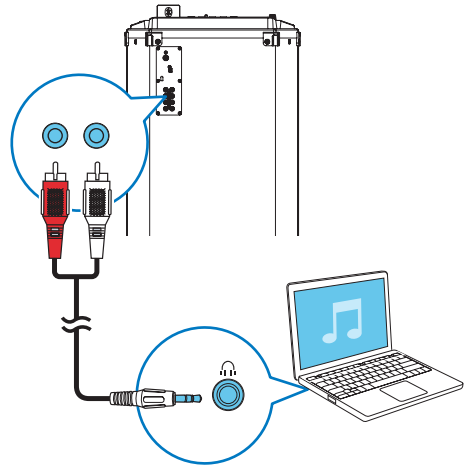



# 6 Listen to radio

## Tune to a radio station



Tip

- Keep the unit away from other electronic devices to avoid radio interference.
- For better reception, fully extend and adjust the position of the antenna.

- 1 Slide **CROSS FADER** to the far left.
- 2 Press **TUNER** on the remote control, or  (Left) on the main unit repeatedly to select FM or AM tuner.
- 3 Press and hold **◀◀** or **▶▶** for 2 seconds.
  - ↳ **[SEARCH]** (search) is displayed.
  - ↳ The radio tunes to a station with strong signal automatically.
- 4 Repeat step 3 to tune to more stations.
  - To tune to a station manually, press **◀◀** or **▶▶** repeatedly until you find optimal reception.

## Program radio stations automatically



Note

- You can program a maximum of 30 FM and 10 AM radio stations.

- In tuner mode, press and hold **PROG** for 2 seconds to activate automatic program mode.
- ↳ **[AUTO]** (auto) is displayed.
  - ↳ The unit stores radio stations with sufficient signal strength automatically.
  - ↳ After all available radio stations are stored, the first stored radio station is broadcast automatically.

## Program radio stations manually

- 1 Tune to a radio station.
- 2 Press **PROG** to activate the program mode.
  - ↳ A position number is displayed.
- 3 Press **ALB/PRESET+/-** to allocate a number to this radio station, then press **PROG** to confirm.
- 4 Repeat steps 1-3 to program other stations.



Tip

- To overwrite a programmed station, store another station in its place.

## Select a preset radio station

In tuner mode, press **ALB/PRESET+/-** to select a preset number:

## Change AM tuning grid

In some countries, the AM radio frequency step between adjacent channels is 9 kHz.

- In AM tuner mode, press and hold  for 5 seconds.
  - ↳ The frequency step is changed to 9 kHz.
  - ↳ All preset stations are erased and re-programmed in AM mode.

# 7 Adjust volume level and sound effect

## Adjust volume level

During play, press **VOL +/-** to increase or decrease volume.

## Mute sound

During play, press **MUTE** to mute or unmute sound.

## Apply AUTO DJ effect

The AUTO DJ function adds various sound and playback effects to your music automatically.

- To apply AUTO DJ effects, press **AUTO DJ** repeatedly to select between:
  - **[METAL]** (Metal), and
  - **[PARTY]** (party)
- To turn off the AUTO DJ effects, press **AUTO DJ** repeatedly to select **[OFF]** (Off).
- To adjust the occurrence frequency and sound level of the added effects, rotate the **DJ EFFECT** dial.

### Note

- These effects are added by the application automatically and randomly.
- The function is only available in **USB A** mode.

## Apply DJ effects manually

You can also add the preset DJ effects by yourself.

- Press **DJ EFFECT** repeatedly to select an effect:
  - **[SCRATCH]** (scratch)
  - **[REVERB]** (reverb)
  - **[BEAT BOX]** (beat box)
  - **[YEAH]** (yeah)
- To turn off the DJ effects, press **DJ EFFECT** repeatedly to select **[OFF]** (off).
- To apply the sound level of the added effects, rotate the **DJ EFFECT** dial.

### Note

- The function is not available in **USB B** mode and **Audio in B** mode.

## Select a preset sound effect

The DSC (Digital Sound Control) enables you to enjoy special sound effects.

- During play, press **DSC** repeatedly to select:
  - **[ROCK]**
  - **[POP]**
  - **[TECHNO]**
  - **[JAZZ]**
  - **[SAMBA]**

## Enhance bass

The best Dynamic Bass Enhancement (DBB) setting is generated automatically for each DSC selection. You can manually select the DBB setting that best suits your listening environment.

- During play, press **DBB** repeatedly to select:
  - **DBB 1**
  - **DBB 2**
  - **DBB 3**
  - **DBB OFF**

---

## Apply NX Bass

NX Bass effect adds clean and lively characteristics to your music with rather low background noise.

- 1 Open the cover on the **NX Bass** button.
- 2 Press the **NX Bass** button. The sound will change in 3 stages:
  - Stage 1: The sound volume increases to a higher level and stays at this level for 5 seconds.
    - ↳ **[FIRING]** (firing) is displayed.
  - Stage 2: The sound volume gradually decreases to its original level in 10 seconds.
    - ↳ **[DISCHARGE]** (discharge) is displayed.
  - Stage 3: The sound volume keeps at normal level for 40 seconds.
    - ↳ **[RECHARGE]** (recharge) is displayed.



### Note

- To reactivate the NX bass effect, press the button again after the 3 stages are completed.

---

## Adjust equalizer settings

Custom Equalizer lets you increase or decrease the gain for specific frequency ranges, and adjust audio output to your own preferences.

- 1 Press **CUSTOM** on the main unit.
- 2 Move the slider bars to adjust the equalizer settings for each of the 5 frequency ranges.

# 8 Other features

---

## Mix sound

You can play from **Source A** (Disc/USB A/Bluetooth/Tuner/Audio in A mode) and from **Source B** (USB B/Audio in B mode) at the same time.

- 1 Play from **Source A**.
  - Disc: Select the CD source, and play a track in the loaded disc.
  - Tuner: Tune to a radio station.
  - Audio in A: Select the Audio in A source, and play audio on the connected external device.
  - USB A: Select the USB A source, and play audio on the connected USB A device.
  - Bluetooth: Connect a Bluetooth device, and then play audio on the device.
- 2 Play from **Source B**.
  - Audio in B: Select the Audio in B source, and then play audio on the connected external device.
  - USB B: Select the USB B source, and then play audio on the connected USB B device.
- 3 Use the **CROSS FADER** control to adjust the balance between Source A and Source B channels during playback.

---

## Speak or sing with a microphone

With this unit, you can speak or sing to a music source with a microphone.

- 1 Turn the **MIC** volume knob to the minimum level.
- 2 Connect a microphone (not supplied) to the **MIC 1** or **MIC 2** socket on the top panel.

- 3 Press **CD**, **TUNER**, **USB A**, **AUDIO A**, or **AUX** to select a source, and start play.
- 4 Sing or speak through the microphone.
  - To adjust the volume of the source, press **VOL +/-**.
  - To adjust the volume of the microphone, turn the **MIC** volume knob.

---

## Turn the decorative light on or off

In power-on mode, press **LIGHT** repeatedly to turn the decoration light on or off.

# 9 Product information

## Note

- Product information is subject to change without prior notice.

## Specifications

### Amplifier

Total Output Power	1100 W (THD 30%)
Frequency Response	60 Hz - 16kHz
Aux In/Mp3 Link	1500mV/2000mV

### Disc

Laser Type	Semiconductor
Disc Diameter	12cm/8cm
Support Disc	CD, CD-R, CD-RW, MP3-CD
Audio DAC	24Bits / 44.1kHz
Frequency Response	60Hz -16kHz

### Speakers

Speaker Impedance	2 x 3 ohm
-------------------	-----------

### Tuner

Tuning Range	FM: 87.5 - 108MHz; AM: 531 - 1602kHz (9KHz); 530 - 1700KHz (10KHz)
Tuning Grid	100KHz (FM); 9KHz/10KHz (AM)
Number of Presets	30 FM, 10 AM

### Bluetooth

Bluetooth Version	V2.1+EDR
Supported Profiles	A2DP,AVRCP
Range	10 m (Free space)

### General information

AC power	110 -127V/220 - 240V~, 50/60Hz
Operation Power Consumption	170 W
Standby Power Consumption	35 W
USB direct	Version 2.0/1.1
USB port	DC 5V, 500mA
Dimensions - Main Unit (W x H x D)	390 x 1137 x 477 mm
Weight (without speakers)	26 kg

## USB playability information

### Compatible USB devices:

- USB flash memory (USB 2.0)
- USB flash players (USB 2.0)
- memory cards (requires an additional card reader to work with this unit)

### Supported formats:

- USB or memory file format FAT12, FAT16, FAT32 (sector size: 512 bytes)
- MP3 bit rate (data rate): 32-320 Kbps and variable bit rate
- Directory nesting up to a maximum of 8 levels
- Number of albums/ folders: maximum 99
- Number of tracks/titles: maximum 999
- ID3 tag v1.2 or later
- File name in Unicode UTF8 (maximum length: 128 bytes)

### Unsupported formats:

- Empty albums: an empty album is an album that does not contain MP3 files, and is not shown in the display.
- Unsupported file formats are skipped. For example, Word documents (.doc) or MP3 files with extension .dlf are ignored and not played.
- AAC, WAV, PCM audio files
- WMA files

- Do not use solvents such as benzene, thinner; commercially available cleaners, or antistatic spray intended for analogue records.

### Clean the disc lens

- After prolonged use, dirt or dust may accumulate at the disc lens. To ensure good play quality, clean the disc lens with Philips CD lens cleaner or any commercially available cleaner. Follow the instructions supplied with cleaner.

---

## Supported MP3 disc formats

- ISO9660, Joliet
- Maximum title number: 999 (depending on file name length)
- Maximum album number: 99
- Supported sampling frequencies: 32 kHz, 44.1kHz, 48 kHz
- Supported Bit-rates: 32-320 (kbps), variable bit rates
- ID3 tag v1.2 or later
- Directory nesting up to a maximum of 8 levels

---

## Maintenance

### Clean the cabinet

- Use a soft cloth slightly moistened with a mild detergent solution. Do not use a solution containing alcohol, spirits, ammonia or abrasives.

### Clean discs

- When a disc becomes dirty, clean it with a cleaning cloth. Wipe the disc from the centre out.



# 10 Troubleshooting



## Caution

- Never remove the casing of this unit.

To keep the warranty valid, never try to repair the system yourself.

If you encounter problems when using this unit, check the following points before requesting service. If the problem remains unsolved, go to the Philips web site ([www.philips.com/support](http://www.philips.com/support)). When you contact Philips, ensure that your unit is nearby and the model number and serial number are available.

### No power

- Make sure that the AC power plug of the unit is connected properly.
- Make sure that there is power at the AC outlet.

### No sound or poor sound

- Adjust the volume.
- Check that the speakers are connected correctly.
- Check if the stripped speaker wires are clamped.

### No response from the unit

- Disconnect and reconnect the AC power plug, then turn on the unit again.

### Remote control does not work

- Before you press any function button, first select the correct source with the remote control instead of the main unit.
- Reduce the distance between the remote control and the unit.
- Insert the batteries with their polarities (+/- signs) aligned as indicated.
- Replace the batteries.
- Aim the remote control directly at the sensor on the front of the main unit.

### No disc detected

- Insert a disc.
- Check if the disc is inserted upside down.
- Wait until the moisture condensation at the lens has cleared.
- Replace or clean the disc.
- Use a finalized CD or correct format disc.

### Cannot display some files in USB device

- The number of folders or files in the USB device has exceeded a certain limit. This phenomenon is not a malfunction.
- The formats of these files are not supported.

### USB device not supported

- The USB device is incompatible with the unit. Try another one.

### Cannot apply sound effects when playing from a USB B device.

- USB B mode does not support **DBB**, **DSC**, **DJ EFFECT** or **AUTO DJ** effects.

### Cannot delete files from a USB B device.

- USB B mode does not support USB Delete function.

### Poor radio reception

- Increase the distance between the unit and other electrical appliances.
- Adjust the position of the antenna for better reception.

---

## About Bluetooth device

### The audio quality is poor after connection with a Bluetooth-enabled device.

- The Bluetooth reception is poor. Move the device closer to this product or remove any obstacle between them.

### Cannot connect with the device.

- The Bluetooth function of the device is not enabled. Refer to the user manual of the device for how to enable the function.
- This product is already connected with another Bluetooth-enabled device. Disconnect that device and then try again.

### The paired device connects and disconnects constantly.

- The Bluetooth reception is poor. Move the device closer to this product or remove any obstacle between them.
- For some devices, Bluetooth connection may be deactivated automatically as a power-saving feature. This does not indicate any malfunction of this product.

# 11 Notice

Any changes or modifications made to this device that are not expressly approved by WOOX Innovations may void the user's authority to operate the equipment.

## Disposal of your old product



Your product is designed and manufactured with high quality materials and components, which can be recycled and reused. Do not throw away the product with the normal household waste at the end of its life, but hand it in at an official collection point or recycling. By doing this, you help to preserve the environment.

### Environmental information

All unnecessary packaging has been omitted. We have tried to make the packaging easy to separate into three materials: cardboard (box), polystyrene foam (buffer) and polyethylene (bags, protective foam sheet.)

Your system consists of materials which can be recycled and reused if disassembled by a specialized company. Please observe the local regulations regarding the disposal of packaging materials, exhausted batteries and old equipment.

**This apparatus includes this label:**



This is CLASS II apparatus with double insulation, and no protective earth provided.



**Be responsible  
Respect copyrights**

The making of unauthorized copies of copy-protected material, including computer programs, files, broadcasts and sound recordings, may be an infringement of copyrights and constitute a criminal offence. This equipment should not be used for such purposes.



**Note**

- The type plate is located on the back of the unit.







2015 © WOOX Innovations Limited. All rights reserved.

This product was brought to the market by WOOX Innovations Limited or one of its affiliates, further referred to in this document as WOOX Innovations, and is the manufacturer of the product. WOOX Innovations is the warrantor in relation to the product with which this booklet was packaged. Philips and the Philips Shield Emblem are registered trademarks of Koninklijke Philips N.V.

NTRX700\_77\_UM\_V1.0

