

DVD Soundmachine

AZ5737

User manual

Руководство пользователя



PHILIPS

This product incorporates copyright protection technology that is protected by method claims of certain U.S. patents and other intellectual property rights owned by Macrovision Corporation and other rights owners. Use of this copyright protection technology must be authorized by Macrovision Corporation, and is intended for home and other limited viewing uses only unless otherwise authorized by Macrovision Corporation. Reverse engineering or disassembly is prohibited.

Laser safety

This unit employs a laser. Due to possible eye injury, only a qualified service person should remove the cover or attempt to service this device.

Class II equipment symbol 

This symbol indicates that the unit has a double insulation system

CAUTION

Use of controls or adjustments or performance of procedures other than herein may result in hazardous radiation exposure or other unsafe operation.

Index

English 4

Русский 30

English

Русский

Contents

General Information

Features	5
Discs for playback	5
Region codes	
Supplied accessories	5
Environmental information	6
Care and safety information	6

Functional Overview

Controls on the system	7
Remote control	8

Connection

Connecting a TV set	9
Connecting the power cord	9

Preparations

Step 1: Inserting batteries into the remote control	10
Step 2: Setting the TV set	10-11
Step 3: Setting language preference	11

Basic Operations

Switching on/off the system and selecting sound source	12
Adjusting volume	12
Switching off the volume temporarily.....	12

Disc Operations

Playing discs	12
Using the disc menu	12
Basic playback controls	13
Skipping to another title (track)/chapter	
To go directly to any title (track)/chapter	
Fast search	
Continuing playback from the last stop point	
Selecting various mode functions	13-14
Repeat play mode	
Shuffle play mode	
Repeating a section within a chapter/track	
Programing favorite tracks	14
Special DVD/VCD features	15-17
Changing subtitle language	
Changing the pictures scales	
Changing view angle	
Changing sound track language	
Searching for a particular passage	
Displaying the disc information during playback	
Moving to another title / chapter	
Playing from a selected point	

Playing in slow motion mode	
Viewing from another angle	
Advancing by frames	
Playback control (PBC)	
Checking the contents of DVD	

MP3/Picture Disc Operations

Playing MP3/Picture disc (Kodak, JPEG)	18
MP3/JPEG picture disc	18
Kodak picture disc	18

DVD Menu Operations

Using the menu bar	19
Using the setup menu	20-21
Setting the TV shape	
Setting the screen saver	
Night mode - turning on/off	
Test Tone	
Changing the password	
Restricting playback by setting parental level	

Tape Operation/Recording

Tape playback	24
General information on recording	24
Preparation for recording	25
Disc synchro recording.....	25

Tuner Operations

Tuning to radio stations	25
To improve radio reception	

Specifications

Troubleshooting

Glossary

Features

Your DVD Soundmachine with 2.0-channel full analog amplifier creates the same dynamic sound qualities that you find in full-fledged cinemas and incorporates some of the best features in home theater technology.

Other features include:

Night mode

Lets you compress the dynamic range, reducing the difference in loudness between different sounds in Dolby Digital mode.

Parental control (rating level)

Lets you set a rating level so that your children cannot watch a DVD that has a rating higher than you set.

Environmental information

Any unnecessary packaging has been omitted. We have tried to make the packaging easy to separate into three materials: cardboard (box), polystyrene foam (buffer) and polyethylene (bags, protective foam sheet).

Your system consists of materials which can be recycled and reused if disassembled by a specialised company. Please observe the local regulations regarding the disposal of packaging materials, exhausted batteries and old equipment.

Disposal of your old product

Your product is designed and manufactured with high quality materials and components, which can be recycled and reused.



When this crossed-out wheeled bin symbol is attached to a product it means the product is covered by the European Directive 2002/96/EC

Please inform yourself about the local separate collection system for electrical and electronic products.

Please act according to your local rules and do not dispose of your old products with your normal household waste. The correct disposal of your old product will help prevent potential negative consequences for the environment and human health.

Supplied accessories

- Composite video cable (yellow)
- Audio cables (white, red)
- Remote Control
- AC power cable

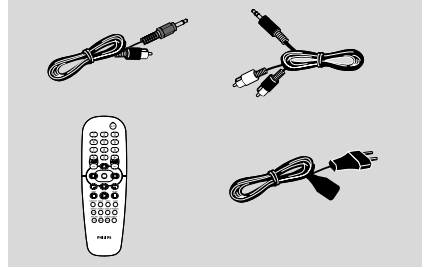

Discs for playback

Your DVD system will play:

- Digital Video Discs (DVDs)
- Video CDs (VCDs)
- SuperVideo CDs (SVCDs)
- Digital Video Discs + Rewritable (DVD+RW)
- Compact Discs (CDs)
- Picture (Kodak, JPEG) files on CDR(W)
- Supported MP3-CD format
 - ISO 9660 / UDF format
 - Max. title/album name –12 characters
 - Max. title number plus album is 255.
 - Max. nested directory is 8 levels.
 - The max. album number is 32.
 - The max. MP3 track number is 999.
 - Supported sampling frequencies for MP3 disc: 32 kHz, 44.1 kHz, 48 kHz.
 - Supported Bit-rates of MP3 disc are: 32, 64, 96, 128, 192, 256 (kbps).
- Following formats can't be supported
 - The files like *.VMA, *.AAC, *.DLF, *.M3U, *.PLS, *.WAV
 - Non-English Album/Title name
 - The discs recorded under Joliet format



General Information

Region codes

DVDs must be labeled for **ALL regions** or for **Region 5** in order to play on this system. You cannot play discs that are labeled for other regions.



Notes:

- For mixed mode discs, only one mode will be selected for playback according to the recording format.
- If you are having trouble playing a certain disc, remove the disc and try a different one. Improperly formatted discs will not play on this system.

Care and safety information

Avoid high temperatures, moisture, water and dust

- Do not expose the system, batteries or discs to humidity, rain, sand or excessive heat (caused by heating equipment or direct sunlight). Always keep disc trays closed to avoid dust buildup on the lens.
- No objects filled with liquids, such as vases, shall be placed on the apparatus.
- No naked flame sources, such as lighted candles, should be placed on the apparatus.

Avoid condensation problem

- The lens may cloud over when the player is suddenly moved from cold to warm surroundings, making it impossible to play a disc. Leave the player in the warm environment until the moisture evaporates.

Do not block the vents

- Do not operate the system in an enclosed cabinet and allow about 15 cm (6 inches) of free space all around the player for adequate ventilation.

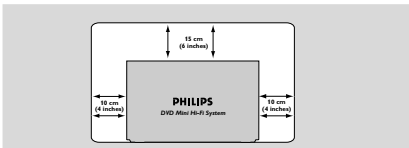

- The ventilation should not be impeded by covering the ventilation openings with items, such as newspapers table-cloths, curtains, etc.

Cleaning the cabinet

- Use soft cloth slightly moistened with a mild detergent solution. Do not use a solution

containing alcohol, spirits, ammonia or abrasives.

Cleaning discs

- To clean a CD, wipe it in a straight line from the center towards the edge using soft and lint-free cloth. A cleaning agent may damage the disc.
- Write only on the printed side of a CDR(W) and only with a soft felt-tipped pen.
- Handle the disc by its edge. Do not touch the surface.

Cleaning the disc lens

- After prolonged use, dirt or dust may accumulate at the disc lens. To ensure good playback quality, clean the disc lens with Philips CD Lens Cleaner or any commercially available cleaner. Follow the instructions supplied with cleaner.



Finding a suitable location

- Place the player on a flat, hard, stable surface.

Cleaning the head and the tape paths

- To ensure good recording and playback quality, clean the head (A), the capstan(s) (B), and pressure roller(s) (C) after every 50 hours of tape operation.
- Use a cotton swab slightly moistened with cleaning fluid or alcohol.
- You also can clean the head by playing a cleaning tape once.

Demagnetising the head

- Use a demagnetising tape available at your dealer.

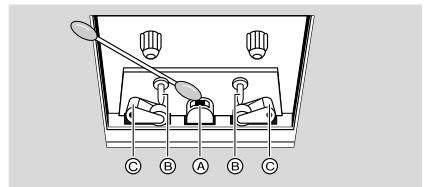

- Where the MAINS plug or an appliance coupler is used as the disconnct device, the disconnct device shall remain readily operable.
- Don't expose the system to dripping or splashing.
- Install this unit near the AC outlet and where the AC Power can be reached easily.
- **When the system is switched to standby mode, it is still consuming some power. To disconnect the system from the power supply completely, remove the AC power plug from the wall sockets.**

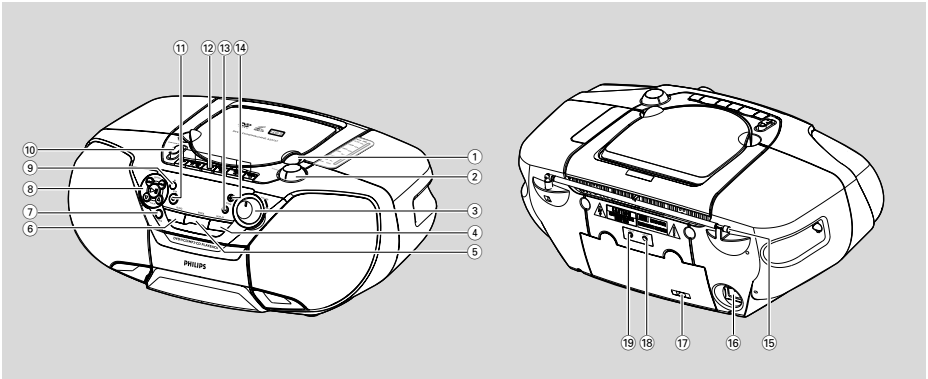

Controls on the system

① LIFT TO OPEN

- to open the disc cover

② TUNING

- to tune to a radio station

③ VOLUME

- to adjust volume level

④ DISPLAY

- to display disc information during disc playback
- to select the slide show mode in playing picture disc mode

⑤ MODE

- to select the repeat function in disc mode

⑥ AUDIO

- to select preferred language for audio
- to select an audio mode when playing a SVCD/ VCD disc with different channels recorded

⑦ PROG

- in disc mode, to program favorite tracks

⑧ SEARCH ◀◀ / ▶▶

- in disc mode, press to skip to the previous/next chapter/track.
- in disc mode, press and hold to fast reverse/ forward the disc
- in JPEG disc mode, press and hold to reduce or enlarge picture.

PLAY/PAUSE ▶▶

- to start or interrupt disc playback
- to resume playback from last stop point

ALBUM ▲ / ▼

- to select previous/nex album in MP3 stop mode (with MENU ON)

⑨ iR

- point the remote control towards this sensor

⑩ SOURCE

- to select sound source for functions:
DVD/VCD/MP3/CD, FM, MW, TAPE

⑪ STOP ■

- to stop playback or to clear a programme

⑫ Cassette recorder keys PAUSE II

- to pause playback or recording
- STOP ■ / OPEN ▲**
- to stop the tape
- to open the cassette compartment
- SEARCH ◀◀ / ▶▶**
- to fast winds/rewinds tape
- PLAY ◀**
- to start playback
- RECORD ●**
- to start recording

⑬⑭ ZOOM-/+

- to reduce or enlarge picture in playing disc mode

⑮ Telescopic aerial

- to improve FM reception

⑯ AC MAINS~

- Socket for power cord

⑰ Voltage selector

- adjusts to match the local voltage
110-127/220-240V before plugging in the set

⑱ Video out

- connects video input jack on the TV

⑲ Audio out

- connects audio input jack on the TV

Functional Overview

Remote control

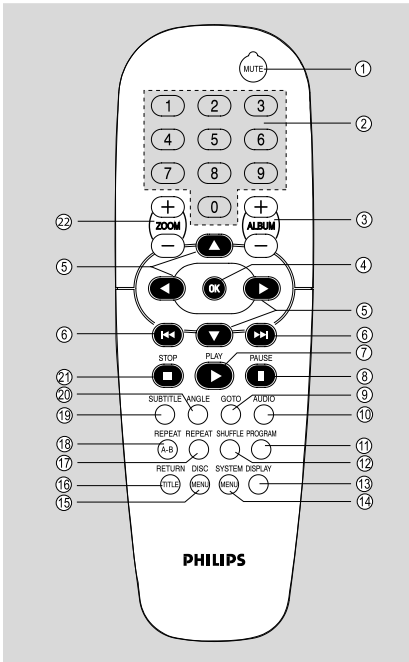

Notes:

- The supplied remote control is for discs operation only.
- First, select the disc (DVD/VCD/MP3/CD) source on the set, then select the desired function (◀◀, ▶▶ or ▶ for example).

① MUTE

- disables or enables sound output

② Numeric Keypad (0-9)

- to enter a track/title number of the disc.

③ ALBUM +/-

- to select previous/nex album in MP3 stop mode (with MENU ON)

④ OK

- to exit or confirm the selection.

⑤ ▲ / ▼ / ◀ / ▶

- to select movement direction in disc contents menu/system menu bar
- in JPEG disc mode, to rotate the picture for viewing.
- in DVD/MP3/VCD/SVCD/CD disc mode, press ◀ / ▶ to fast reverse/forward the disc
- moves an enlarged picture up/down/left/right

⑥ ◀◀ / ▶▶

- in disc mode, press to skip to the previous/next chapter/track.

⑦ PLAY ▶

- to start the disc playback

⑧ PAUSE II

- to interrupt disc playback or resume playback from last stop point.

⑨ GOTO

- to go direct to desired title, chapter or time.

⑩ AUDIO

- for VCD/SVCD, sets the audio mode (VCD: left vocal, right vocal, mono left, mono right or stereo), (SVCD: AUDIO1, AUDIO2, AUDIO1 VOCAL, AUDIO2 VOCAL)
- for DVD, selects an audio language

⑪ PROGRAM

- in disc mode, to program favorite tracks.

⑫ SHUFFLE

- to playback in random mode.

⑬ DISPLAY (OSD)

- to display disc information during disc playback
- to select the slide show mode in playing picture disc mode

⑭ SYSTEM MENU (disc mode only)

- to enter or exit the system menu bar.

⑮ DISC MENU (disc mode only)

- to enter or exit the disc contents menu
- in VCD/SVCD mode, to select PBC ON or PBC OFF.

⑯ RETURN TITLE

- to return to main page for VCD
- to return to title menu for DVD

⑰ REPEAT

- to select variations of continuous playback

⑱ REPEAT A-B

- to repeat a specific section within a chapter/track

⑲ SUBTITLE

- to select desired subtitle

⑳ ANGLE

- to select the angles cyclically

㉑ STOP ■

- to stop playing the disc.

㉒ ZOOM +/-

- to reduce or enlarge picture in playing disc mode

Connecting a TV set

Note:

- Connect the system directly to the TV set.

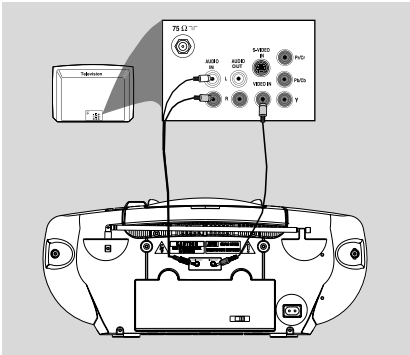

- Use the supplied composite video cable (yellow) to connect the system's **VIDEO OUT** jack to the video input jack (or labeled as A/V In, Video In, Composite or Baseband) on the TV set.
- To listen to disc playback of the system through your TV, use the supplied audio cables to connect **AUDIO OUT** jack (black) to the corresponding AUDIO IN jacks (red/white) on the TV set.

Connecting the power cord

IMPORTANT!

- If your system is equipped with a Voltage Selector, set the **VOLTAGE SELECTOR** (located on the back of the set) to match the local power line.
- The type plate is located on the rear of the set.

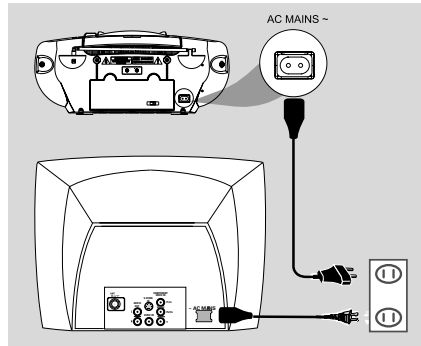

- After everything is connected properly, plug in the AC power cord to the power socket.

Never make or change any connection with the power switched on.

Note:

- The set is operated on AC power only.

Notes:

- The type plate is located on the bottom of the set.
- Never make or change any connection with the power switched on.

Preparations

IMPORTANT!

– Make sure to complete the preparation procedures before operating the system.

Step 1: Inserting batteries into the remote control

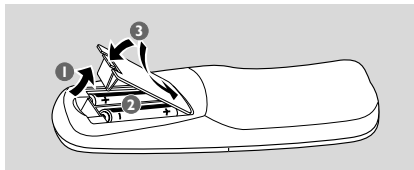

- 1 Open the battery compartment.
- 2 Place two batteries (Type R06 or AA) in the compartment with the correct polarity as indicated by “+” and “-” symbols.
- 3 Close the cover:

Using the remote control to operate the system (It is only available in disc mode)

- 1 Adjust the source switch to DVD/VCD/MP3/CD grade.
- 2 Point the remote control directly at the remote sensor (IR) on the front panel.
- 3 Then select the desired function (for example: ◀◀, ▶▶ or II)

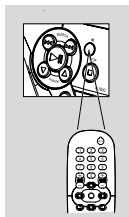

CAUTION!

– Remove batteries if they are exhausted or will not be used for a long time.

– Do not use old and new or different types of batteries in combination.

– Batteries contain chemical substances, so they should be disposed of properly.

Step 2: Setting the TV set

IMPORTANT!



– Make sure you have completed all the necessary connections.

- 1 Push the source switch to disc mode.
- 2 Turn on the TV set and set to the correct Video-In channel. You should see the blue Philips DVD background screen on the TV set.
 - You may go to channel 1 on your TV set, then press the channel down button repeatedly until you see the Video In channel.
 - Or, you can use the TV remote control to select different video modes.
 - Or, set TV to channel 3 or 4 if you are using an RF modulator.

Selecting the color system that matches your TV set

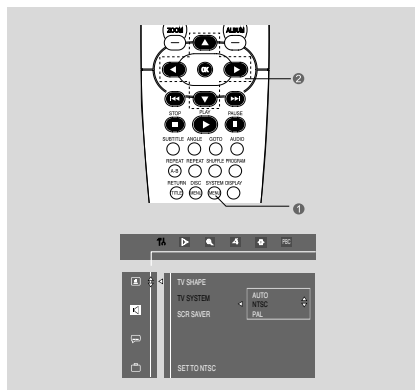
This DVD Soundmachine is compatible with both NTSC and PAL. For the playback of a DVD disc on this DVD Soundmachine, the color systems of the DVD, TV set and DVD Soundmachine should match.



- 1 In disc mode, stop playback and press **SYSTEM MENU**.
- 2 Select  icon and press **▼**.
- 3 Press **▲ / ▼ / ◀ / ▶** keys on the remote control to toggle through the functions and select your preferred option.
 - Move to  and press **▶**.
 - Move to "TV System" and press **▶**.

AUTO

– Select this if the connected TV set is compatible with both NTSC and PAL (multi system). The output format will be consistent with the video signal of the disc.

NTSC

– Select this if the connected TV set is NTSC system. It will change the video signal of a PAL video disc and output to NTSC system.

PAL

– Select this if the connected TV set is PAL system. It will change the video signal of an NTSC disc and output to PAL format.

- 4 Select an item and press **OK**.



To remove the menu

Press **SYSTEM MENU**.

Step 3: Setting language preference

You can select your preferred language settings so that this DVD Soundmachine will automatically switch to the language for you whenever you load a disc. If the language selected is not available on the disc, the language set by default will be used instead. But the menu language of the DVD Soundmachine cannot be changed once selected.



- 1 In disc mode, stop playback and press **SYSTEM MENU**.
- 2 Select  icon and press **▼**.
- 3 Press **▲ / ▼ / ◀ / ▶** keys on the remote control to select your preferred option.
 - Move to  and press **▶**.
 - Move to one of the following and press **▶**.
 - Audio (disc's soundtrack)
 - Subtitle (disc's subtitles)
 - Disc Menu (on screen menu)
- 4 Press **▲ / ▼** to select a language and press **OK**.
- 5 Repeat **steps 3~4** for other settings.

To remove the menu

Press **SYSTEM MENU**.

Basic Operations

Basic function

Switching on/off the system and selecting sound source

- To select your sound source (switch on the system), adjust the **source selector** on the set to: DVD/VCD/MP3/CD, FM, MW, TAPE source.
→ The system will switch to the selected source.
- To switch off the system, adjust the **source selector** on the set to **OFF** position and check the cassette keys are released.

Adjusting volume

- Adjust the volume with **VOLUME** control.

Switching off the volume temporarily

- In disc mode, press **MUTE** on the remote control.
→ "MUTE" is displayed.
Press **MUTE** again to cancel the **MUTE** mode.

IMPORTANT!

- This system is designed for regular discs. Therefore, do not use any accessories such as disc stabiliser rings or disc treatment sheets, etc., as offered on the market, because they may jam the disc mechanism.
- Do not move the system during playback. Doing so may damage the system.
- Do not put any object other than disc on the disc tray. Doing so may cause the system to malfunction.
- DVD discs and players are designed with regional restrictions. Before playing a disc, make sure the disc matches the regional code of your player.
- According to the format requirement of DVD or VCD, some operations may be different or restricted.

Disc Operations

Playing discs

- Push the source switch to the disc mode on the system.
- Power on the TV system and set to the correct Video In channel .
→ You should see the blue Philips DVD background screen on the TV set.
- Lift the disc cover to open the disc tray and load a disc respectively.
→ Make sure the disc label is facing up. For double-sided discs, load the side (marked "side A" or "side B") you want to play facing up.
- Press the disc cover to close the disc tray.
→ **LOADING** will be displayed.
- Some discs can play automatically. For discs with Table Of Contents, a menu may appear on the TV screen. When the menu is displayed, press **▲ / ▼ / ◀ / ▶** keys to highlight your selection and press **OK** to confirm. To select a play option, press **numeric keys (0-9)**.
→ If the disc is locked by parental control, you must enter your four-digit password .
- Press **▶||** on the front panel or **PLAY ▶** on the remote control to start playback.

For MP3

- Load an MP3 disc in the disc tray.
→ Press **DISC MENU** to select menu on/off.

Notes:

- Load discs with the label side facing up.
- To ensure good system performance, wait until disc reading is completed before proceeding.

Using the disc menu

For disc with Table Of Contents, a menu may appear on the TV screen once you load the disc.

To select a playback feature or item

- Press **▲ / ▼ / ◀ / ▶** or **numeric keys (0-9)** on the remote control, then press **▶||** on the front panel or **PLAY ▶** on the remote control or **OK** to start playback.

To access or remove the menu

- Press **DISC MENU** on the remote control.

Basic playback controls

To start playback

- Press **▶II** on the front panel or **PLAY ▶** on the remote control.

To interrupt playback

- Press **▶II** on the front panel or **PAUSE II** on the remote control.
- To resume playback, press **▶II** on the front panel or **PLAY ▶** on the remote control again.

To stop playback

- Press **■**.

Skipping to another title (track) /chapter

- Press **◀◀ / ▶▶** on the front panel or on the remote control repeatedly during playback to skip backward or forward. Each press will take the disc to the beginning of the previous or next title (track) / chapter.

Note:

– If the player has been set to repeat chapter (track), pressing this button will replay the same chapter (track) from its beginning.

To go directly to any title (track) / chapter

For CD/VCD(PBC off)/MP3

- Use the **numeric keys (0-9)** to enter the number of the desired track.

For DVD

- Please see page 16 "Moving to another title(track)/chapter".

Fast search

- 1 Press and hold **◀◀ / ▶▶** on the front panel more than 3 seconds or press **◀ / ▶** on the remote control to fast reverse or forward the disc. Repeat the step above to select another speed number.
- 2 To resume normal play, press **▶II** on the front panel or press **PAUSE II** then press **PLAY ▶** on the remote control.

Continuing playback from the last stop point

- In Pre-stop mode and before the disc is removed, press **▶II** on the front panel or **PLAY ▶** on the remote control to resume playback from where you have stopped.

To cancel the resume mode

- In the stop mode, press **■** again to fully stop the playback, lift to open the disc cover or adjust the source switch to other mode (for example : FM, MW,TAPE)

Notes:

- Resume information will be erased if you have changed the disc, opened the disc cover, changed source or disconnected the system from the power supply.
- This function is not available for MP3 disc.

Selecting various mode functions

Repeat play mode

You can only select the Repeat play mode during playback.

For DVD - repeat chapter/title

- Press **REPEAT** repeatedly to select the following:
REPEAT CHAPTER → REPEAT TITLE → REPEAT OFF

For SVCD/VCD(PBC off) /CD - repeat track/disc

- Press **REPEAT** repeatedly to select the following:
REPEAT TRACK → REPEAT DISC → REPEAT OFF

During program playback

- Press **REPEAT** repeatedly to select the following:
REPEAT TRACK → REPEAT PROGRAM → REPEAT OFF

For MP3 repeat - track/album/disc MENU ON:

- Press **REPEAT** repeatedly to select the following:
REPEAT TRACK → REPEAT ALBUM → REPEAT DISC → REPEAT OFF
MENU OFF:
- Press **REPEAT** repeatedly to select the following:
REPEAT TRACK → REPEAT DISC → REPEAT OFF

Disc Operations

Notes:

- When you open the disc tray, the Repeat function will be cancelled automatically.
- For SVCD and VCD 2.0 discs, the Repeat function is not available when the PBC function is set to ON.

Shuffle play mode

In this mode, all tracks in the current directory will be played once in a random order.

- 1 In stop mode (by pressing ■ twice), press **SHUFFLE** repeatedly to select the following: SHUFFLE DISC → REPEAT SHUFFLE DISC → SHUFFLE OFF
- 2 Press ►|| on the front panel or press **PLAY** ► on the remote control to start shuffle play.

In shuffle playback mode:

- Press ◀◀/▶▶ button to select another track in a shuffle order.
- 3 Press ■ to stop shuffle playback.

To cancel Shuffle mode:

- Press twice **STOP** to cancel Shuffle mode.

Notes:

- When the disc cover is opened, the Shuffle function will be cancelled automatically.
- This function is only available for CD or VCD/ SVCD (PBC OFF).

Repeating a section within a chapter / track

You can play a specific section in a chapter/track repeatedly.

- 1 Press **REPEAT A-B** at your chosen start point.
- 2 Press **REPEAT A-B** again at your chosen end point.
→ The passage will now repeat continuously.
- 3 To resume normal play, press **REPEAT A-B** again.

Note:

- The REPEAT A-B function can only be set within the same chapter or track.

Programing favorite tracks

You can play the contents of the disc in the order you want. At most 99 tracks can be stored.

- 1 Load the desired discs on the disc trays.
- 2 While playback is stopped (by pressing ■ twice), press **PROGRAM** to enter program mode.
→ "P 00 :00" is displayed.
- 3 Use the **numeric keys (0-9)** to input the track number in the order you want.
→ If you attempt to program more than 99 tracks, "FULL" is displayed.
- 4 Press **OK** (or **PROGRAM**) to store the track.
- Repeat **steps 3-5** to store other tracks.
- 5 Press ►|| on the front panel or press **PLAY** ► on the remote control to play the program.

To Erase program

You can erase program by doing one of the following:

- During program playback, press ■ twice.
- Select other sources.
- Open the disc door.
→ "PRG" disappears from the display.

Note:

- This function is not available for DVD or MP3 discs.

Special DVD/VCD features

Changing subtitle language

This operation only works on DVDs with multiple subtitle languages.

- Press **SUBTITLE** to select the desired language.

Changing the picture scales

This operation only works on VCDs/DVDs/ JPEGs with images.

For VCD/SVCD/DVD:

- Press **ZOOM +** or **ZOOM -** to change the zooming scale:
→ Zooming number will be displayed on the TV screen.

For JPEG:

- 1 In the menu bar (See page 15), select ZOOM ON in the **ZOOM** item.
- 2 Press **ZOOM +/-** (or press and hold **◀◀/▶▶** on the set) to change the picture zooming scale.
- To pan through the enlarged image, press **▲ / ▼ / ◀ / ▶** buttons to move the zoomed picture left, right, up or down.
- 3 To turn off zooming, select ZOOM OFF in the **ZOOM** item in the displayed menu bar.

Changing view angle

If the playing DVD disc is recorded with multiple camera angles, the ANGLE mark on the setup page will be set to ON automatically. This allows you to view the picture from different angles.

- Press **ANGLE** buttons to select the desired angle: 1/4, 2/4, 3/4 or 4/4.

Changing sound track language

This operation only works on DVDs with multiple audio languages.

- Press **AUDIO** to select the desired language.

For VCD/SVCD:

- Press **AUDIO** to select the desired audio channels for sound. This function is only available for discs recorded with different channels:
VCD: LEFT VOCAL → RIGHT VOCAL → MONO LEFT → MONO RIGHT → STEREO
SVCD: AUDIO1, AUDIO2, AUDIO1 VOCAL, AUDIO2 VOCAL

Note:

– If your desired language is not set in the disc, you cannot select the language via this function.

Searching for a particular passage

- 1 Press and hold **◀◀/▶▶** on the set (or press **◀ / ▶** on the remote control) to select fast reverse search or fast forward search respectively.
- 2 Press and hold **◀◀/▶▶** on the set (or press **◀ / ▶** on the remote control) to select the required search speed:

For DVD or MP3

(reverse): FR X2 → FR X4 → FR X6 → FR X8 → PLAY

(forward): FF X2 → FF X4 → FF X6 → FF X8 → PLAY

For SVCD, VCD or CD

(reverse): FR X1 → FR X2 → FR X3 → FR X4 → PLAY

(forward): FF X1 → FF X2 → FF X3 → FF X4 → PLAY

- 3 To resume normal play, press **▶II** on the system or press **PAUSE II** then press **PLAY ▶**.

Displaying the disc information during playback

- In disc mode, press **DISPLAY** repeatedly to select the following display information:

For DVDs:

TITLE ELAPSED - elapsed playback time of current title

TITLE REMAIN - remaining time of current title

CHAPTER ELAPSED - elapsed playback time of current chapter

CHAPTER REMAIN - remaining time of current chapter

OFF - turns off the display information

For VCDs (PBC OFF)/ CDs:

SINGLE ELAPSED - elapsed playback time of current track

SINGLE REMAIN - remaining time of current track

TOTAL ELAPSED - elapsed playback time of disc

TOTAL REMAIN - remaining playback time of disc

OFF - turns off the display information

Disc Operations

Moving to another title / chapter

Some discs may contain more than one title or chapter. If the disc has a title or chapter menu recorded on it, you can start playback from the selected item.

For DVD only

- 1 Press **GOTO** on the remote control to display the message of title and chapter; use ◀ / ▶ to highlight an item.
- 2 Use **numeric keys (0-9)** to select a desired title/chapter number.
- 3 Press **OK** to start playback.

Note:

– Selecting a title or chapter might not be possible on certain discs.

Playing from a selected point

This function allows you to start playback at any chosen time on the disc.

For DVD

- 1 Press **GOTO** twice to activate time menu.
- 2 Enter hours, minutes and seconds from left to right in the time edit box using the **numeric keys (0-9)**.
- 3 Press **OK** to start playback.

For SVCD, VCD (PBC OFF) or CD

- 4 Press **GOTO** to activate time menu, "GOTO -- : --" will be displayed on the TV screen.
- 5 Enter minutes and seconds from left to right in the time edit box using the **numeric keys (0-9)**.
- 6 Press **OK** to start playback.

Note:

– In repeat disc or repeat all mode, you can search a desired time point.
– This function is not available for MP3 disc.

Some operations can be carried out directly via the menu bar on the TV screen without interrupting disc playback.

- 1 Press **SYSTEM MENU**.
→ The menu bar will be displayed across the top of the TV screen.
- 2 Press ◀ / ▶ to select:
SETUP MENU → SLOW → ZOOM → ANGLE → STEP → PBC ON/OFF.
- 3 Press ▼ to select your preferred option.
- 4 To exit, press **SYSTEM MENU**.

IMPORTANT!

Some operations may be different or restricted according to the disc format. Refer to the jacket or case of the disc you are playing.

Note:

– When you press a button and  appears on the TV screen, this means the function is not available on the current disc or at the current time.

Playing in slow motion mode



For DVD

- 1 Select  from the menu bar and press ▼ repeatedly to select the required slow motion speed:
SF X 2 → SF X 4 → SF X 8 → SR X 2 → SR X 4 → SR X 8 → PLAY
SF = slow forward
SR = slow reverse

For SVCD or VCD

- 1 Press ▼ to select the required slow motion speed:
(forward): SF X 1 → SF X 2 → SF X 3 → PLAY
- 2 Press ▶|II or ▶ to cancel the slow function.

Note:



– This function is not available for CD or MP3 disc.

Disc Operations

Viewing from another angle



If the playing DVD disc is recorded with multiple camera angles, the ANGLE mark on the setup page will be set to ON automatically. This allows you to view the picture from different angles. Angle selection is determined by the disc format.

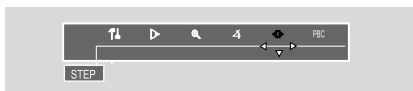

- Select  from the menu bar and press  to select the desired angle: 1/4, 2/4, 3/4 or 4/4.
→ Playback changes to the selected angle.

Advancing by frames



- 1 Select  from the menu bar and press  to play the disc step by step (one frame each step).
- 2 To resume normal play, press .

Note:

– This function is not available for CD or MP3 disc.

Playback control (PBC) - 2.0 VCD only

PBC playback allows you to play Video CD interactively, following the menu on the display.

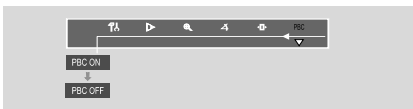

- Select **PBC ON/OFF** from the menu bar and press  to toggle between PBC ON and PBC OFF.





Playing a disc with PBC function

- If PBC OFF, the system will start playback automatically.
- If PBC ON, the PBC menu (if available) will appear on the TV screen for selection. Use the **numeric keys (0-9)** to enter your choice.

Note:

– This function is not available for DVD, CD or MP3 disc.

Checking the contents of DVD

- 1 Press **DISC MENU** on the remote control.
→ If the current title has a menu, the menu will appear on the screen. Otherwise, the disc menu will be displayed.
- 2 Press  /  /  /  to select the desired title or chapter; and then press **PLAY**  or **OK**.
→ Playback start from the selected title or chapter.
- 3 Press **DISC MENU** on the remote control to go to disc menu of the disc.

Note:

– If no title menu or root menu is recorded in the DVD disc, pressing this button will restart playback from the first track.

MP3/ Picture Disc Operations

Playing MP3/Picture disc (Kodak, JPEG)

IMPORTANT!

– You have to turn on your TV set and set to the correct Video In channel.

MP3/JPEG Picture disc

- Load an MP3/Picture (JPEG) disc.
→ The disc reading time may exceed 30 seconds due to complexity of the directory/file configuration.
- Playback will start automatically.
→ The album/picture menu will appear on the TV screen. If not, press **DISC MENU** on the remote control.

(MP3 disc menu)

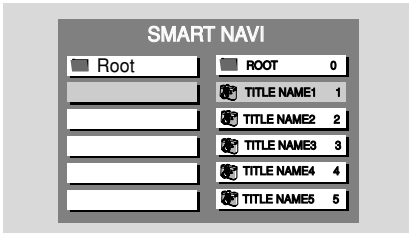

- In STOP mode, press **▲ / ▼ / ◀ / ▶** on remote control to select a desired album, then press **OK** or **PLAY ▶** to confirm (for MP3 disc only).
 - In STOP mode, press **▲ / ▼** to select a desired title, then press **OK** or **PLAY ▶** to start playback.
 - You can also use the **numeric keys (0-9)** to enter your choice.
 - To stop playback, press **■**.
 - Press **▲ / ▼** on the set to select previous /next album.
- If the MP3 menu is switched off**
- You can only play the current title by pressing **PLAY ▶**. While in playback mode, press **◀◀ / ▶▶** to select the previous/next title.
→ The title number will appear.
- Note:**
- No album search function in menu off mode.
- During JPEG or Kodak Picture disc playback, press **DISPLAY** key repeatedly to select different scan effect. There are 12 types of scan effect for selection. The selected scan effect will be displayed on the TV screen.

Kodak Picture disc

- Load a Kodak Picture disc.
→ The disc reading time may exceed 30 seconds due to complexity of the directory/file configuration.
- Playback will start automatically.
- Press **■**.
→ 9 thumbnail pictures will appear on the TV screen.

(example for picture disc menu)

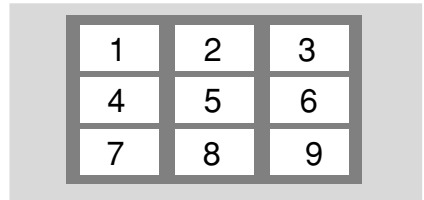

- Press **◀◀ / ▶▶** to view the previous/next page (if available).
- Press **▲ / ▼ / ◀ / ▶** to pan the zoomed enlarge picture to up / down / left / right, but to exit the system menu first.
- Press **DISPLAY** to select the slide-show mode to playback.

During playback, you can:

- Press **◀◀ / ▶▶** to select another title/picture in the current folder.
- Press **▲ / ▼ / ◀ / ▶** on the remote control to rotate or flip the picture files.
- Press **||** on the system to pause/resume playback.

Notes:

- Due to the recording nature of Digital Audio MP3 (DAM), only digital audio music will play.
- It is normal to experience an occasional "skip" while you are listening to your MP3 discs.
- For multi-session discs with different formats, only the first session can be read and played.
- **DISC MENU** does not function during Kodak Picture disc playback.

Using the menu bar

You can continue some operations directly via the menu bar on the TV screen without interrupting the disc playback. But when you enter **FA** (SETUP MENU), the playback will pause.

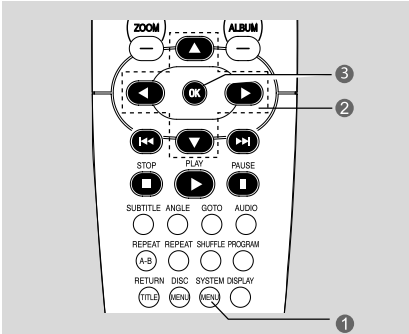

▶	Slow Motion The slow motion speed will display. Press ▼ repeatedly to select a reverse or forward slow motion speed. To cancel the slow function, press ►
🔍	ZOOM Press ▼ repeatedly to select an enlarged picture ratio: 1.5, 2 or 3. To resume normal playback, repeat the above step to select ZOOM OFF.
↗	ANGLE Press ▼ to view the same scene from different angles if the DVD is recorded with multi-angles.
⏮	STEP Press ▼ repeatedly to play forward the disc step by step (one frame every step). To cancel the step function, press ►
PBC	PBC Press ▼ to select PBC ON or OFF, and then playback will automatically start from the beginning of the disc. (This function is not available for DVD/CD or MP3 discs.)

- In disc mode, press **SYSTEM MENU**.
→ The menu bar will appear across the top of the TV set screen.



- Press the ▲ / ▼ / ◀ / ▶ on the remote control to navigate in the menu.
→ Press ◀ / ▶ to move through the menu bar.
→ Press ▼ to enter the selection.
- Press **OK** to confirm the selection.

To remove the menu

Press **SYSTEM MENU** or **OK**.

IMPORTANT!

- Some operations may be different or restricted according to the disc format. Refer to the jacket or care of the disc you are playing.
- You can change the Subtitle Language and Audio Language from the menu bar only on the current disc. But this operation cannot change the default preset.

DVD Menu Operations

Using the setup menu (user preference settings)

This DVD setup is carried out via your TV set, enabling you to customize the DVD System to suit your particular requirements.

- In disc mode, press **SYSTEM MENU**.
→ The menu bar will appear across the top of the TV screen.
- Select  icon and press **▼** to enter the setup menu. Then press **▲ / ▼** to select one of the setup menu options and press **▶** to enter the menu.
→ Playback will pause.

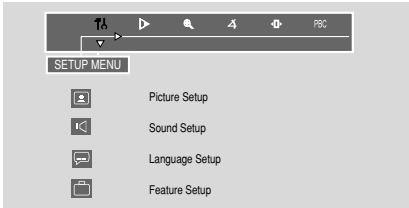

- Press **▲ / ▼ / ◀ / ▶** on the remote control to navigate in the menu.
- Press **OK** to confirm your selection.

Removing the menu

Press **SYSTEM MENU** or **OK**.

Note:

– Some features of the Setup Menu are described in "Preparations".

Setting the TV shape

Make sure the format you need is available on the disc. If not, your setting will be invalid.

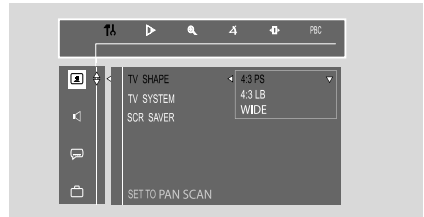

4:3PS (Pan and Scan mode)

Select this if you have a conventional TV set and your DVD is not formatted for wide screen viewing. A wide picture will display on the whole TV screen with a portion automatically cut off.

4:3LB (Letterbox mode)

Select this if you have a conventional TV set and your DVD is formatted for wide screen viewing. Black bars appear on the upper and lower portions of the TV screen.

Wide (Wide-screen TV)

Select this if you have a wide-screen TV set (you must also set your wide screen TV to "full size").

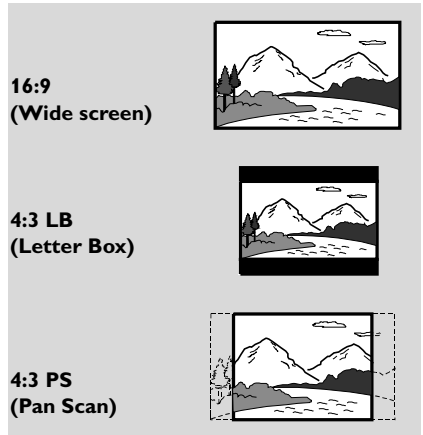

Setting the screen saver

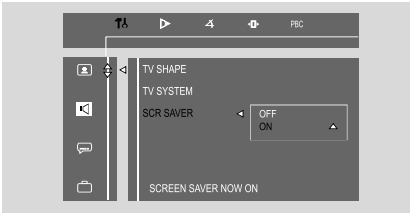

ON

If set to ON, the screen saver will be activated when you leave the system in stop or pause mode for 5 minutes. The default setting is ON.

OFF

If screen saver set to off, in any status, the screen saver will not activate.

Night mode - turning on/off

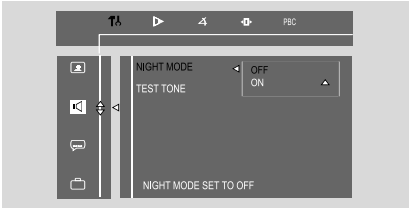

Off

Select this when you want to enjoy the surround sound with its full dynamic range.

On

Select this to level out the volume. High volume output will be softened and low volume output will be brought upward to an audible level. This feature is only available for movies with Dolby Digital mode.

Test Tone

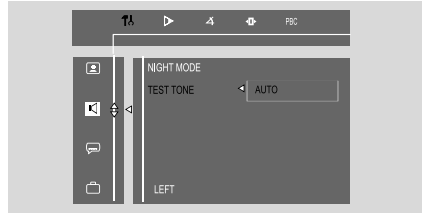

AUTO

Select this item system will start testing the speaker from left to right cyclically until you exit tone test.

Note:

– You can press ◀ to exit test tone mode at any time.

DVD Menu Operations

Changing the password

You can change the four-digit code used as Password.

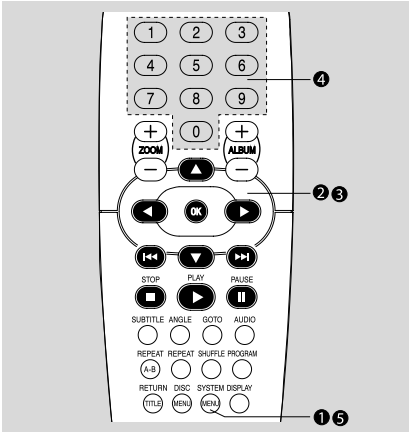

- 1 In disc mode, press **SYSTEM MENU**.
- 2 Select **PA** icon and press **▼**.
- 3 Press **▲ / ▼ / ◀ / ▶** on the remote control to navigate in the menu.
 - Move to **PA** icon and press **▶**.
 - Move to "PASSWORD" and press **▶**.

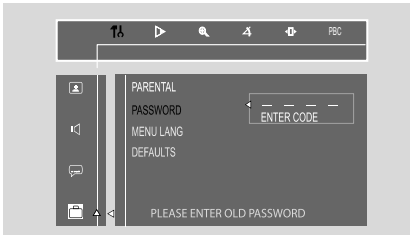

- 4 Use the **numeric keys (0-9)** to enter your four-digit code.
 - The password supplied by default is 1234.
 - If you forget the four-digit code, press **■** four times, the system will change back to the default password.
- 5 Enter your new code. Then press the same code again to confirm.

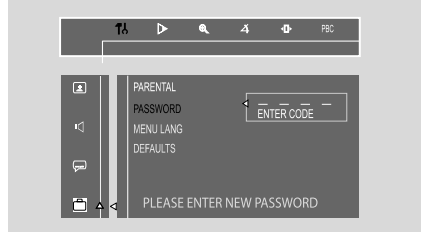

- 6 Press **SYSTEM MENU** again to remove the menu.

DVD Menu Operations

Restricting playback by setting parental level

Some DVDs may have a parental level assigned to the complete disc or to certain scenes on the disc. This feature lets you set a playback limitation level. The rating levels are from 1 to 8 and are country specific. You can prohibit the playing of certain discs that are not suitable for your age certain discs played with alternative scenes.

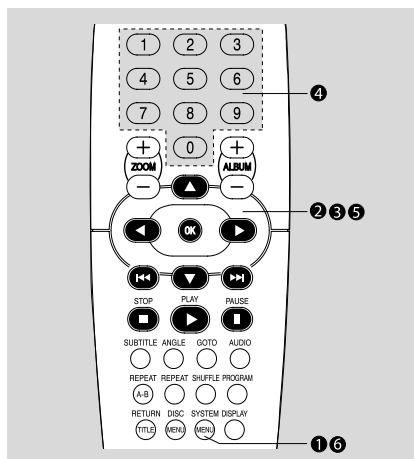

- 1 In disc mode, press **SYSTEM MENU**.
- 2 Select icon and press **▼**.
- 3 Use **▲ / ▼ / ◀ / ▶** on the remote control to navigate in the menu.
 - Move to icon and press **▶**.
 - Move to "PARENTAL" and press **▶**.

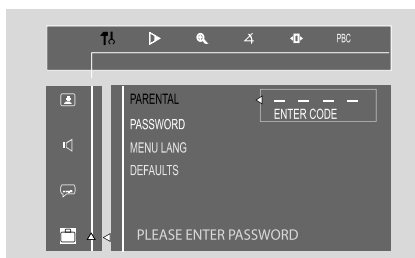

- 4 Use the **numeric keys (0-9)** to enter the four-digit code. You may have to enter the same code twice.
- 5 Press **▲ / ▼** to select a rating level between 1-8 and press **OK**.
 - DVDs rated above the level you select will not play unless you enter your four-digit password or choose a higher level rating. Select 'No Parental' to deactivate Parental level and have all discs play.

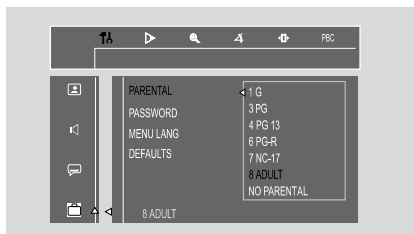

- 6 Press **SYSTEM MENU** again to remove the menu.

Rating explanations

NO PARENTAL – It will play all discs.

8 ADULT – material for adults only; viewed only by adults due to graphic sexual scenes, violence, or language.

7 NC-17 – No children under age 17; not recommended for children under age 17.

6 PG-R – Parental Guidance – Restricted; recommended that parents restrict children under 17 from viewing or allow them to view only when supervised by a parent or adult guardian.

4 PG 13 – Material is unsuitable for children under age 13.

3 PG – Parental Guidance suggested.

1 G – General Audience; recommended as acceptable for viewers of all ages.

– Menu language

To set the screen display language. The default setting is English.

– Default

If RESET is selected, all the items in the setup menu will be reset to default setting, except Parental Setting and Password.

Tape Operation/Recording

IMPORTANT!

- Before playing a tape, check and tighten slack tape with a pencil. Slack tape may get jammed or may burst in the mechanism.
- Store tapes at room temperature and do not put them too close to a magnetic field (for example, a transformer, TV set or speaker).
- In disc mode or tuner mode, tape playback is not available but record function is available.

Tape playback

- 1 Adjust the source to select the TAPE mode.
- To control tape playback, you must use the cassette key on the top of the system!

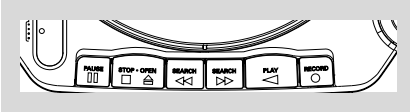

- 2 Press ▲ on the set to open the tape deck door.
- 3 Insert a recorded tape and close the tape door.
- Load the tape with the open side up and the full spool to the right.

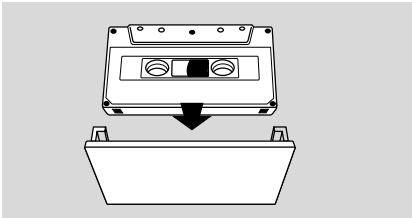

- 4 Adjust **source selector** on the set to select **TAPE** source.
- 5 Press **PLAY** ◀ on the set to start playback.

Interrupting playback

- Press **PAUSE** || to interrupt playback.

Stopping playback

- Press **STOP** ■ / **OPEN** ▲ to stop playback.

Rewinding or forwarding fast when playback is stopped

- 1 Press **SEARCH** ◀◀ or ▶▶ on the top of the system.
- 2 Press **STOP** ■ / **OPEN** ▲ when you reach the desired passage.

General information on recording

- Recording is permissible insofar as copyright or other rights of third parties are not infringed.
- For recording, only use tape of IEC type I (normal tape).
- The recording level is set automatically, regardless of the position of the Volume, Vocal, Key control and so forth.
- The type is secured at both ends with leader tape. At the beginning and end of the tape, nothing will be recorded for seven seconds.
- To prevent accidental recording, break out the tab on the left shoulder of the tape side you want to protect.
- Press REC in Disc, FM or MW mode, the record key ● can't be pressed if there is no recordable tape in tape deck.

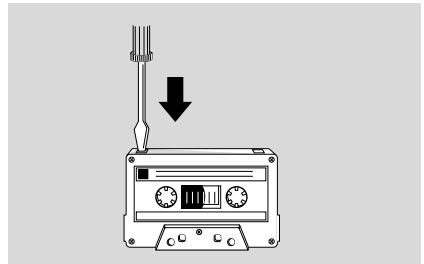

IMPORTANT!

- Recording is permissible if copyright or other rights of third parties are not infringed upon.
- Recording is possible only in tape deck.

Preparation for recording

- 1 Load a recordable tape with the open side up and the full spool to the right.
- 2 Prepare the source to be recorded.
DVD/VCD/MP3/CD – load the disc(s)
FM or **MW** – tune to the desired radio station.
- 3 On the set, select **DVD/VCD/MP3/CD**, or **FM** or **MW** as desired source.
- 4 Start to play the selected source.
- 5 Press **RECORD** ● to start recording.

To stop recording

- Press **STOP** ■ / **OPEN** ▲ on the set.

Disc synchro recording

- 1 Select **DVD/VCD/MP3/CD** on the set.
- You can record programmed tracks in the order you want.
- 2 Press **RECORD** ● to start recording.

Selecting another track during recording

- 1 Press **PAUSE** II to interrupt recording.
- 2 Press **◀◀** / **▶▶** to select another track.
- 3 Press **PAUSE** II to resume recording.

To stop recording

- Press **STOP** ■ / **OPEN** ▲ on the set.
→ Recording will stop.

IMPOTANT!

The making of unauthorized copies of copy-protected material, including computer programmes, files, broadcasts and sound recordings, may be an infringement of copyrights and constitute a criminal offence. This equipment should not be used for such purposes.

Tuning to radio stations

- 1 Adjust **Source selector** to select **FM** or **MW**.
- 2 Adjust the **TUNING** knob to tune to a radio station.
→ The radio station will be show on the graduation of reciver:
→ The graduation is only show the approximate number of the radio station for your reference.

To improve radio reception

You can adjust the **TUNING** slowly to tune to a radio station until an optimal reception is found.

- For FM, extend, incline and turn the telescopic antenna. Reduce its length if the signal is too strong.
- For MW, the set uses a built-in antenna. Direct this antenna by turning the whol set.

Notes:

- In tuner mode, remote control and LCD display is not available.
- The band range is:
MW: 526.5 - 1605.5 KHz
FM: 87.5 - 108 MHz



Be responsible
Respect copyrights

Specifications

AMPLIFIER SECTION

Output power (L/R)	1 W/channel RMS
CD Frequency Response
.....	100Hz - 10kHz / ± 3 dB
CD Signal-to-Noise Ratio > 50dB (A-WEIGHED)
Output Sensitivity
Line Out(1kHz 0dB)	$2 \pm 0.2V$

TUNER SECTION

Tuning Range
.....	FM 87.5 – 108 MHz
.....	MW 526.5 – 1605.5 kHz
Signal-to-Noise Ratio	FM ≥ 50 dB
.....	MW ≥ 30 dB

TAPE SECTION

Frequency Response
Normal tape	125 Hz - 8 kHz / ± 4 dB
Signal-to-Noise Ratio
Normal tape	≥ 45 dB
JIS and WTD	$\leq 0.35\%$

DVD SECTION

Laser-Type	Semiconductor
Video Decoding	MPEG-2 / MPEG-1
Video DAC	10 Bits
Signal System	PAL / NTSC
Video Format	4:3 / 16:9
Video S/N	56 dB (minimum)
Composite Video Output	1.0Vp-p, 75 Ω

MAIN UNIT

Power Supply Rating	110 - 127 / 220 - 240 V
.....	50/60HZ Switchable
Power Consumption
Active	15 W
Dimensions (w x d x h) 400x 242.5 x 169 (mm)
Weight	3.9 kg
Packaging Dimensions (w x d x h)
.....	458x280x210(mm)
Gross weight	3.06kg

SPEAKERS

Impedance	8 Ω
Speaker drivers	full range 4" 1 w/ shield

Specifications subject to change without prior notice

WARNING

Under no circumstances should you try to repair the system yourself, as this will invalidate the warranty. Do not open the system as there is a risk of electric shock.

If a fault occurs, first check the points listed below before taking the system for repair. If you are unable to remedy a problem by following these hints, consult your dealer or service center.

Problem	Solution
No power.	<ul style="list-style-type: none"> – Check if the AC power cord is properly connected.
"NO DISC" is displayed.	<ul style="list-style-type: none"> – Insert a disc. – Check if the disc is inserted upside down. – Wait until the moisture condensed at the lens has cleared. – Replace or clean the disc, see "Maintenance". – Use a readable disc or correctly recorded format MP3-CD.
No picture on TV screen.	<ul style="list-style-type: none"> – Select the appropriate video input mode on the TV set. – Check if the TV set is switched on. – Check the video connection. – Check if the system is securely connected.
No colour on TV	<ul style="list-style-type: none"> – TV has a colour system standard. If the disc's or DVD system's colour system is different than your TV's colour system, the picture may be distorted or colourless. – Change the system to the respective PAL or NTSC setting.
Distorted or poor picture.	<ul style="list-style-type: none"> – Sometimes a slight picture distortion may appear. This is not a malfunction. – Clean the disc.
The aspect ratio of the screen cannot be changed even though you have set the TV shape.	<ul style="list-style-type: none"> – The aspect ratio is fixed on the DVD disc. – The aspect ratio may not be changed for some TV systems.
The DVD player does not start playback.	<ul style="list-style-type: none"> – Check the source switch on the disc mode. – Insert a readable disc. – Check the disc type, color system and region code. – Clean the disc. – Place the disc with the playback side down. – Press SYSTEM MENU to turn off the setup menu. – Cancel the parental control rating function or change the rating level. – Moisture has condensed inside the system. Remove the disc and leave the system turned on for about an hour.

Troubleshooting

The system does not respond when the buttons are pressed.

- Confirm the source switch location. Some buttons/knob/keys are available only in the related mode (for example cassette recorder keys is available only in TAPE mode.).
- Disconnect the power plug from the jack, and insert again.

The language subtitle cannot be changed when playing a DVD.

- Multi-language subtitle is not recorded on the DVD.
- Changing the language for subtitle is prohibited on the DVD.

Sound cannot be heard or is of poor quality

- Adjust the volume.
- If the system is in pause, slow motion or fast forward/reverse mode, press ►► to resume the normal play mode.
- Make sure the MP3-CD was recorded within 32-256 kbps bit rate with sampling frequencies at 48 kHz, 44.1 kHz or 32 kHz.

Poor radio reception.

- If the signal is too weak, adjust the antenna for better reception.
- Increase the distance between the System and your TV set or VCR.

Recording or playback cannot be made

- Clean deck parts, see "Maintenance".
- Use only NORMAL tape.
- Apply a piece of adhesive tape over the missing tab space.

The tape deck door cannot open

- Remove and reconnect the AC power plug and switch on the system again.

The remote control does not function.

- The remote control is available in disc mode only.
- Point the remote control at the remote control sensor of the unit.
- Reduce the distance to the player.
- Remove any possible obstacles.
- Replace the batteries with new ones.
- Check that the batteries are loaded correctly.

Aspect ratio: The ratio of vertical and horizontal sizes of a displayed image. The horizontal vs. vertical ratio of conventional TVs is 4:3, and that of wide-screens is 16:9.

AUDIO OUT Jacks: Jacks on the back of the DVD System that send audio to another system (TV set, Stereo, etc.).

Bit Rate: The amount of data used to hold a given length of music; measured in kilobits per second, or kbps. Or, the speed at which you record. Generally, the higher the bit rate better the sound quality. However, higher bit rates use more space on a Disc.

Chapter: Sections of a picture or a music piece on a DVD that are smaller than titles. A title is composed of several chapters. Each chapter is assigned a chapter number enabling you to locate the chapter you want.

Disc menu: A screen display prepared for the selection of images, sound, subtitles, multi-angles, etc recorded on a DVD.

JPEG: A still-picture data compression system proposed by the Joint Photographic Expert Group, which features small decrease in image quality in spite of its high compression ratio.

MP3: A file format with a sound data compression system, "MPE" is the abbreviation of Motion Picture Experts Group 1 (or MPEG-1) Audio Layer 3. Through the MP3 format, one CD-R or CD-RW can contain about 10 times as much data volume as a regular CD can.

Parental control: A function of the DVD to limit playback of the disc by the age of the users according to the limitation level in each country. The limitation varies from disc to disc; when it is activated, playback will be prohibited if the software's level is higher than the user-set level.

Playback control (PBC): Refers to the signal recorded on video CDs or SVCDs for reproduction control. By using screen menus recorded on a Video CD or SVCD that supports PBC, you can enjoy interactive-type software as well as software having a search function.

Region code: A system allowing discs to be played only in preset regions. This unit will only play discs that have compatible region codes. You can find the region code of your unit from the product label. Some discs are compatible with more than one region (or ALL regions).

Title: The longest section of a picture or music feature on DVD, music, etc., in video software, or the entire album in audio software. Each title is assigned a title number enabling you to locate the title you want.

VIDEO OUT jack: Jack on the back of the DVD System that sends video to TV.

Meet Philips at the Internet
<http://www.philips.com>

English

Русский

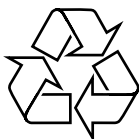

AZ5737



Printed in China

PDCC-JH/ZC-0722