

MP3-CD Mini Hi-Fi System

FWM582

User manual

Manual do usuário

Manual del usuario



PHILIPS



México



Es necesario que lea cuidadosamente su instructivo de manejo.

	PRECAUCIÓN - ADVERTENCIA	
	No abrir, riesgo de choque eléctrico	
	ATENCIÓN	
	Verifique que el voltaje de alimentación sea el requerido para su aparato	
Para evitar el riesgo de choque eléctrico, no quite la tapa. En caso de requerir servicio, dirijase al personal calificado.		

Descripción: **Minisistema de Audio**
 Modelo : **FWM582/55**
 Alimentación: **110-127 / 220-240V~; 50-60 Hz**
 Consumo: **165W**
 Importador: **Philips Mexicana, S.A. de C.V.**
 Domicilio: **Av. La Palma No.6**
Col. San Fernando La Herradura
Huixquilucan
 Localidad y Tel: **Edo. de México C.P. 52784**
Tel.52 69 90 00
 Exportador: **Philips Electronics HK, Ltd.**
 País de Origen: **China**
 N° de Serie: _____

LEA CUIDADOSAMENTE ESTE INSTRUCTIVO ANTES DE USAR SU APARATO.

AVISO IMPORTANTE

Philips Mexicana, S.A. de C.V. no se hace responsable por daños o desperfectos causados por:

- *Maltrato, descuido o mal uso, presencia de insectos o roedores (cucarachas, ratones etc.).*
- *Cuando el aparato no haya sido operado de acuerdo con el instructivo del uso, fuera de los valores nominales y tolerancias de las tensiones (voltaje), frecuencia (ciclaje) de alimentación eléctrica y las características que deben reunir las instalaciones auxiliares.*
- *Por fenómenos naturales tales como: temblores, inundaciones, incendios, descargas eléctricas, rayos etc. o delitos causados por terceros (choques asaltos, riñas, etc.).*

CAUTION

Use of controls or adjustments or performance of procedures other than herein may result in hazardous radiation exposure or other unsafe operation.



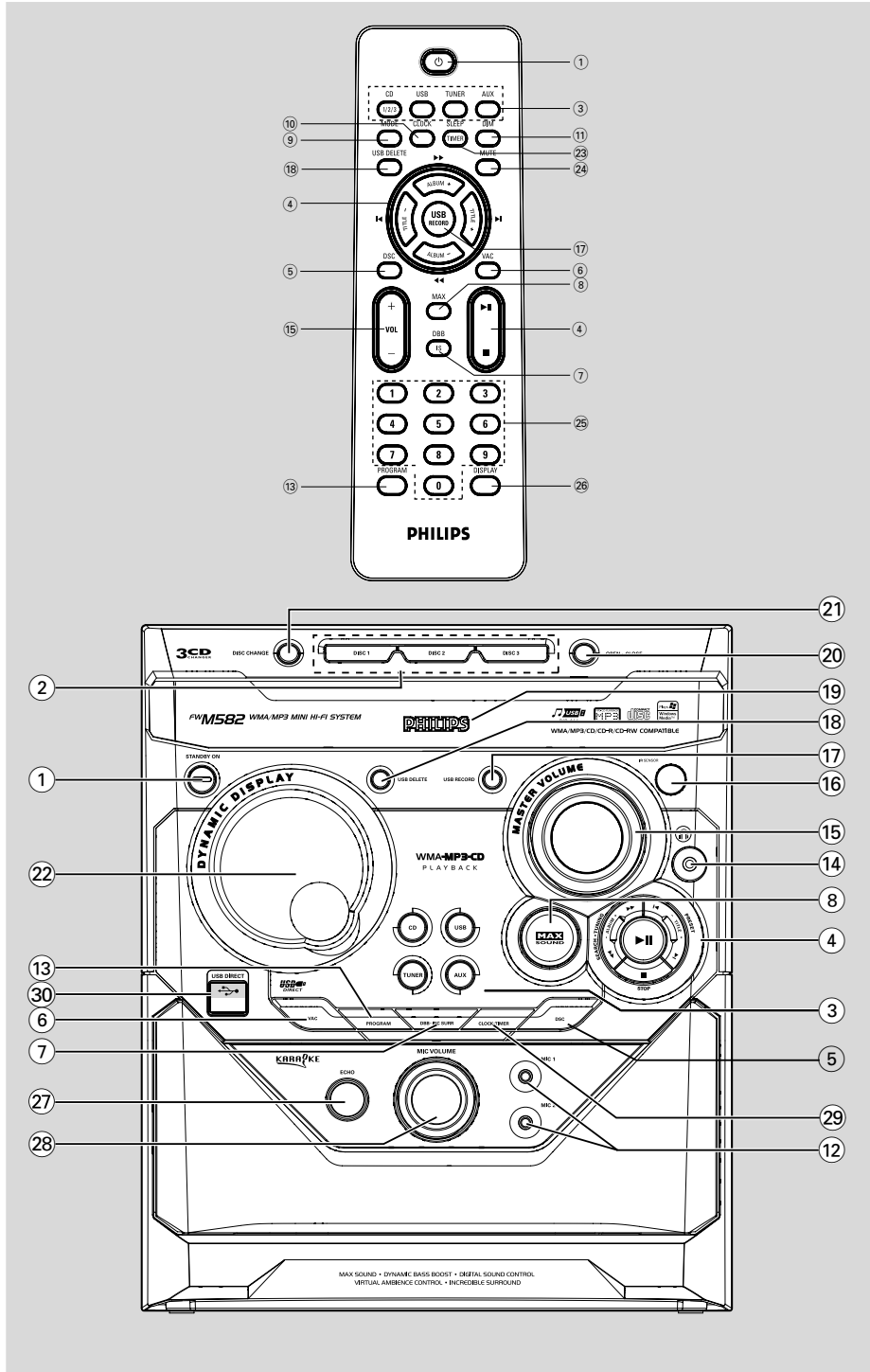

3





DEMO MODE

To turn ON

Press & HOLD



button

for 5 seconds

To turn OFF

Press & HOLD



button

for 5 seconds

PLUG & PLAY -for tuner installation

1



Plug in the unit

2



Follow instructions
in the display

3



Press "PLAY"



Index

English 6

Español 29

Português 52

English

Español

Português



Contents

General Information

Supplied accessories	7
Environmental information	7
Safety information	7

Preparations

Rear connections	8–9
Power	
Antennas Connection	
Speakers Connection	
Optional connection	9
Connecting a USB device or memory card	
Inserting batteries into the remote control...	9

Controls

Controls on the system and remote control ...	
.....	10–11

Basic Functions

Plug and Play	12
Demonstration mode	13
Switching the system on	13
Switching the system to standby mode	13
Dim mode	13
Volume control	14
Sound control	14
MAX Sound	
VAC (Virtual Ambience Control)	
DSC (Digital Sound Control)	
DBB (Dynamic Bass Boost)	
Incredible Surround	
Karaoke	14

CD/MP3-CD Operations

Discs for playback	15
About MP3 disc	15
Loading discs	15
Playing discs	16
Replacing discs during playback	16
Selecting a desired track/passage	16
Selecting a desired Album/Title	16
Different play modes: SHUFFLE and REPEAT ...	
.....	17
Programming the disc tracks	17
Erasing the programme	17

Radio Reception

Tuning to radio stations	18
Storing preset radio stations	18–19
Automatic Preset Programming	
Manual Preset Programming	
Tuning to preset radio stations	19
Changing tuning grid	19

External Sources

Connecting external equipment	20
Using a USB mass storage device	20
Ripping function	22
Tuner record timer setting	23

Clock/Timer

View clock	24
Clock setting	24
Timer setting	25
To deactivate the TIMER	
To activate the TIMER	
Sleep timer setting	25

Specifications 26 |

Maintenance 27 |

Troubleshooting 27–28 |

General Information

IMPORTANT!
PLEASE NOTE THAT THE VOLTAGE SELECTOR LOCATED AT THE REAR OF THIS SYSTEM IS PRESET AT 220V FROM THE FACTORY. FOR COUNTRIES THAT OPERATE AT 110V-127V, PLEASE ADJUST TO 110V-127V BEFORE YOU SWITCH ON THE SYSTEM.

Supplied accessories

- 2 speaker boxes
- remote control
- MW loop antenna
- FM wire antenna
- AC power cord

Environmental information

All unnecessary packaging has been omitted. We have tried to make the packaging easy to separate into three materials: cardboard (box), polystyrene foam (buffer) and polyethylene (bags, protective foam sheet).

Your system consists of materials which can be recycled and reused if disassembled by a specialised company. Please observe the local regulations regarding the disposal of packaging materials, exhausted batteries and old equipment.

Safety information

- Before operating the system, check that the operating voltage indicated on the typeplate (or the voltage indication beside the voltage selector) of your system is identical with the voltage of your local power supply. If not, please consult your dealer.
- Place the system on a flat, hard and stable surface.
- Place the system in a location with adequate ventilation to prevent internal heat build-up in your system. Allow at least 30 cm (4 inches) clearance from the rear and the top of the unit and 30 cm (2 inches) from each side.
- The ventilation should not be impeded by covering the ventilation openings with items, such as newspapers, table-cloths, curtains, etc.
- Do not expose the system, batteries or discs to excessive moisture, rain, sand or heat sources caused by heating equipment or direct sunlight.
- No naked flame sources, such as lighted candles, should be placed on the apparatus.
- No objects filled with liquids, such as vases, shall be placed on the apparatus.
- Don't expose the system to dripping or splashing.
- Install this unit near the AC outlet and where the AC power can be reached easily.
- The lens may cloud over when the system is suddenly moved from cold to warm surroundings, making it impossible to play a disc. Leave the system in the warm environment until the moisture evaporates.
- The mechanical parts of the set contain self-lubricating bearings and must not be oiled or lubricated.
- **When the system is switched to Standby mode, it is still consuming some power. To disconnect the system from the power supply completely, remove the AC power plug from the wall socket.**

English

Preparations

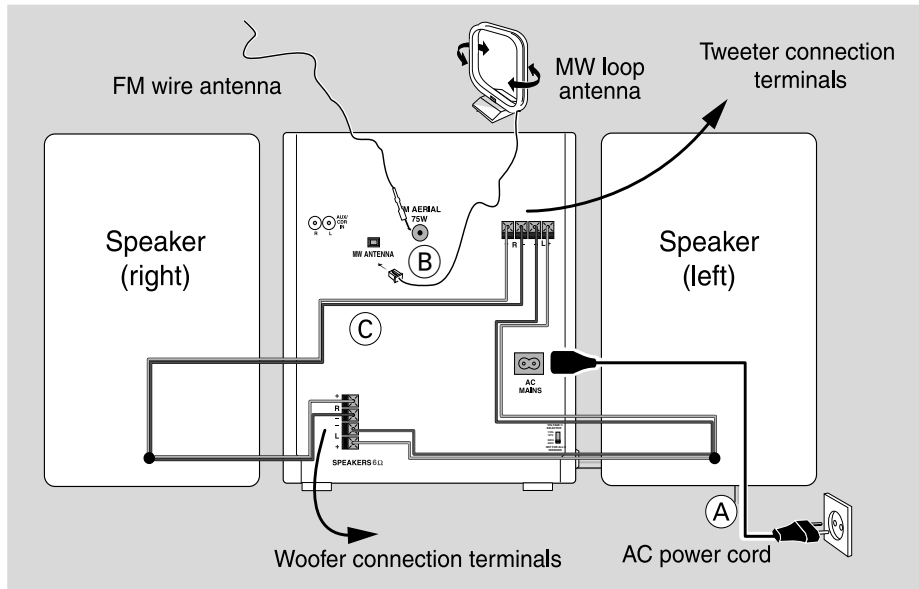

Rear connections

The type plate is located at the rear of the system.

A Power

- Before connecting the AC power cord to the wall outlet, ensure that all other connections have been made.
- If your system is equipped with a Voltage Selector, set the VOLTAGE SELECTOR to the local power line voltage.

Warning!

- For optimal performance, use only the original power cable.
- Never make or change any connections with the power switched on.

To avoid overheating of the system, a safety circuit has been built in. Therefore, your system may switch to Standby mode automatically under extreme conditions. If this happens, let the system cool down before reusing it (not available for all versions).

B Antennas Connection

Connect the supplied MW loop antenna and FM antenna to the respective terminals. Adjust the position of the antenna for optimal reception.

MW Antenna

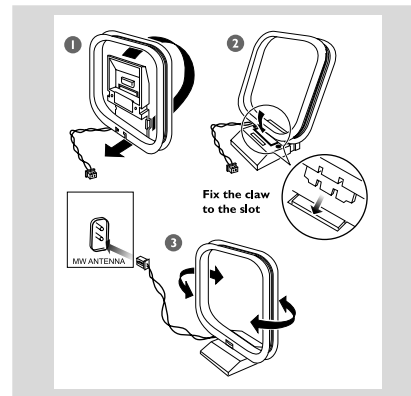

- Position the antenna as far as possible from a TV, VCR or other radiation source.



Preparations

FM Antenna

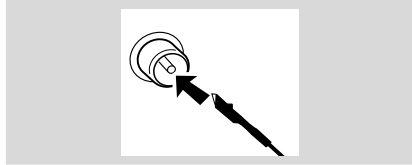

- For better FM stereo reception, connect an outdoor FM antenna to the FM ANTENNA terminal.

Speakers Connection

Front Speakers

Connect the speaker wires to the **SPEAKERS** terminals, right speaker to "R" and left speaker to "L", red wires to "+" and black wires to "-" of the woofer connection terminals, gray wires to "+" and blue wires to "-" of the tweeter connection terminals.

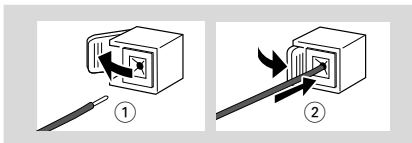

- Fully insert the stripped portion of the speaker wire into the terminal as shown.

Notes:

- For optimal sound performance, use the supplied speakers.
- Do not connect more than one speaker to any one pair of +/- speaker terminals.
- Do not connect speakers with an impedance lower than the speakers supplied. Please refer to the SPECIFICATIONS section of this manual.

Optional connection

The optional equipment and connecting cords are not supplied. Refer to the operating instructions of the connected equipment for details.

Connecting a USB device or memory card

By connecting a USB mass storage device (including USB flash memory, USB flash players or memory cards) to the Hi-Fi system, you can enjoy the device's stored music through the powerful speakers of Hi-Fi system.

- Insert the USB device's USB plug into the  socket on the set.

OR

for the devices with USB cables:

- 1 Insert one plug of the USB cable (not supplied) to the  socket on the set.
- 2 Insert the other plug of the USB cable to the USB output terminal of the USB device.

OR

for the memory card:

- 1 Insert the memory card into a card reader (not supplied).
- 2 Use a USB cable (not supplied) to connect the card reader into the  socket on the set.

Connecting a non-USB device

Use a cinch cable to connect **AUX** to the analogue audio out terminals of an external equipment (TV, VCR, Laser Disc player, DVD player or CD Recorder).

Note:

- If you are connecting equipment with a mono output (a single audio out terminal), connect it to the AUX left terminal. Alternatively, you can use a "single to double" cinch cable (the output sound still remain mono).

Inserting batteries into the remote control

Insert two batteries (Type R06 or AA) into the remote control with the correct polarity as indicated by the "+" and "-" symbols inside the battery compartment.

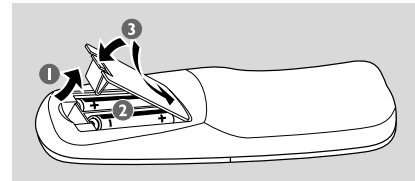

CAUTION!

- Remove batteries if they are exhausted or will not be used for a long time.
- Do not use old and new or different types of batteries in combination.
- Batteries contain chemical substances, so they should be disposed of properly.

Controls (illustrations on page 3)

Controls on the system and remote control

① **STANDBY ON**

- to switch the system on or to standby mode.

② **DISC 1/2/3 (CD 1/2/3)**

- to select a disc tray for playback.

③ **Source selection** – to select the following :

CD

- to select disc source.
- press repeatedly to select a disc tray for playback.

TUNER

- to select waveband: FM or MW.

AUX

- to select the input for an additional appliance : AUX.

USB

- to select USB source directly.

④ **Mode Selection**

ALBUM -/+

- for MP3-CD/USB . to select previous/next album.
- for CD to search backward/forward.
- for Tuner to tune to a lower or higher radio frequency.
- for Clock to set the hour.

STOP ■

- for CD/MP3-CD/USB to stop playback or to clear a programme.
- for Tuner..... (on the system only) to stop programming.
- for Demo (on the system only) to activate/deactivate the demonstration.
- for Clock (on the system only) to exit clock setting.
- for Plug & Play (on the system only) to exit plug & play mode.

▶ ||

- for CD/MP3-CD/USB to start or interrupt playback.
- for Plug & Play (on the system only) to initiate and start plug & play mode.

TITLE -/+ PRESET

- for MP3-CD/USB . to select previous/next title.
- for CD to skip to the beginning of the current, previous, or next track.
- for Tuner to select a preset radio station.
- for Clock to set the minute.

⑤ **DSC**

- to select different type of preset sound equaliser settings (OPTIMAL, JAZZ, ROCK or TECHNO).

⑥ **VAC**

- to select different type of ambience-based equaliser settings (HALL, CONCERT or CINEMA).

⑦ **DBB/INC SURR (DBB/IS)**

- to select the desired bass boost level (DBB 1, DBB 2, DBB 3 or DBB OFF).
- to activate or deactivate the surround sound effect.

⑧ **MAX SOUND (MAX)**

- to activate or deactivate the optimal mix of various sound features.

⑨ **MODE**

- selects different play modes: e.g. REPEAT or SHUFFLE (random order).

⑩ **CLOCK**

- to set or view the clock.



⑪ **DIM**

- to select different brightness for the display screen: DIM 1, DIM 2, DIM 3 or DIM OFF.



Controls

English

- ⑫ **MIC1/2**
 - to connect microphones.
- ⑬ **PROGRAM**
 - for CD/ MP3-CD .to programme disc tracks.
 - for Tuner to programme preset radio stations.
- ⑭ 
 - to connect headphones.
- ⑮ **MASTERVOLUME (VOL +/-)**
 - to increase or decrease the volume.
- ⑯ **IR SENSOR**
 - sensor for the infrared remote control.
- ⑰ **USB RECORD**
 - to copy music to an external portable USB storage device.
- ⑱ **USB DELETE**
 - to delete music stored on the external USB device.
- ⑲ **Disc tray**
- ⑳ **OPEN•CLOSE**
 - to open or close the disc tray.
- ㉑ **DISC CHANGE**
 - to change disc(s).
- ㉒ **Display screen**
 - to view the current status of the system.
- ㉓ **SLEEP/TIMER**
 - to activate/deactivate or set the sleep timer.
- ㉔ **MUTE**
 - to mute or restore the volume.
- ㉕ **NUMERIC KEYS**
 - to input numbers.
- ㉖ **DISPLAY**
 - to display the album and title name for MP3 disc.
- ㉗ **ECHO**
 - to adjust the echo level.
- ㉘ **MICVOLUME**
 - to adjust the mixing level for Karaoke.
- ㉙ **CLOCK•TIMER**
 - to view the clock.
 - to set the clock or set the timer.
- ㉚ **USB DIRECT** 
 - jack for the external USB mass storage device.

Hearing Safety

Listen at a moderate volume.

- Using headphones at a high volume can impair your hearing. This product can produce sounds in decibel ranges that may cause hearing loss for a normal person, even for exposure less than a minute. The higher decibel ranges are offered for those that may have already experienced some hearing loss.
- Sound can be deceiving. Over time your hearing "comfort level" adapts to higher volumes of sound. So after prolonged listening, what sounds "normal" can actually be loud and harmful to your hearing. To guard against this, set your volume to a safe level before your hearing adapts and leave it there.

To establish a safe volume level:

- Set your volume control at a low setting.
- Slowly increase the sound until you can hear it comfortably and clearly, without distortion.

Listen for reasonable periods of time:

- Prolonged exposure to sound, even at normally "safe" levels, can also cause hearing loss.
- Be sure to use your equipment reasonably and take appropriate breaks.

Be sure to observe the following guidelines when using your headphones.

- Listen at reasonable volumes for reasonable periods of time.
- Be careful not to adjust the volume as your hearing adapts.
- Do not turn up the volume so high that you can't hear what's around you.
- You should use caution or temporarily discontinue use in potentially hazardous situations.
- Do not use headphones while operating a motorized vehicle, cycling, skateboarding, etc.; it may create a traffic hazard and is illegal in many areas.

Notes for remote control:

- **First, select the source you wish to control by pressing one of the source select keys on the remote control (CD or TUNER, for example).**
- **Then select the desired function (▶, ◀, ▶/▶, for example).**



Basic Functions

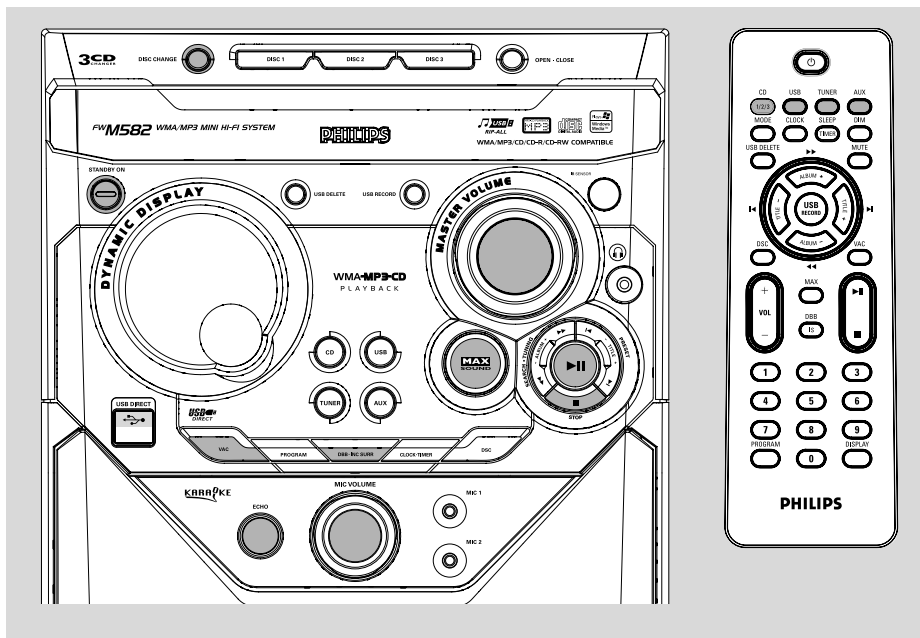

IMPORTANT!

Before you operate the system, complete the preparation procedures.

Plug and Play (for tuner installation)

Plug and Play allows you to store all available radio stations automatically.

First time setup/power up

- 1 When you turn on the main supply, "AUTO INSTALL - PRESS PLAY" is displayed.
- 2 Press ► || on the system to start installation.
 - "PLUG AND PLAY" ... "INSTALL" is displayed, followed by "TUNER" and "AUTO".
 - **PROG** starts flashing.
 - All available radio stations with sufficient signal strength will be stored automatically, starting from FM and followed by MW band.
 - When all the available radio stations are stored or the memory for 40 presets are used, the last preset radio station will be played.

To reinstall Plug and Play

- 1 In standby or demonstration mode, press and hold ► || on the system until "AUTO INSTALL - PRESS PLAY" is displayed.
- 2 Press ► || again to start installation.
 - All previously stored radio stations will be replaced.

To exit without storing the Plug and Play

- Press ■ on the system.
 - If you do not complete the Plug and Play installation, the function will be restarted when you next turn on the main supply again.

Notes:

- When the power is turned on, the disc tray may open and close to initialise the system.
- If no stereo frequency is detected during Plug and Play, "CHECK ANTENNA" will be displayed.
- During Plug and Play, if no button is pressed within 10 seconds, the system will exit Plug and Play mode.



Basic Functions

Demonstration mode

The system has a demonstration mode that shows the various features offered by the system.

To activate the demonstration

- In **standby mode**, press and hold **■** on the system for 3 seconds to switch to demonstration.

To deactivate the demonstration

- Press and hold **■** on the system for 3 seconds to switch to standby mode.

Switching the system on

In standby/demonstration mode

- Press **STANDBY ON**/ to switch to the last selected source.
- Press **CD, TUNER, USB** or **AUX**.
- Press **OPEN-CLOSE, DISC 1/2/3 (CD 1/2/3), DISC CHANGE**.
→ The system will switch to CD mode.

Switching the system to standby mode

In demonstration mode

- Press and hold **■** on the system.

In any other source mode

- Press **STANDBY ON** (or  on the remote control).
→ The clock will appear on the display when the system is in standby mode.

Dim mode

You can select the desired brightness for the display.

- In any source mode, press **DIM** on the remote control repeatedly to select DIM 1, DIM 2, DIM 3 or DIM OFF display mode.
→ **DIM** is shown, except for DIM OFF mode.

DIM mode	Brightness	Spectrum Analyser
1	normal	off
2	half	on
3	half	off
OFF	normal	on

Volume control

Adjust **MASTER VOLUME** to increase (turn knob clockwise or press **VOLUME +**) or decrease (turn knob anti-clockwise or press **VOLUME -**) the sound level.

To listen through the headphones

- Connect the headphones plug to the  socket at the front of the system.
→ The speakers will be muted.



To switch off the volume temporarily

- Press **MUTE** on the remote control.
→ Playback will continue without sound and "MUTE" is displayed.
- To restore the volume, press **MUTE** again or increase the volume level.



Basic Functions

Sound control

For optimal sound listening, select only one of the following navigation sound controls at a time : MAX, DSC or VAC.

MAX Sound

MAX sound provides the best mixture of various sound features (DSC, VAC, DBB, for example).

- Press **MAX SOUND** (or **MAX** on the remote control) repeatedly.
 - If activated, **MAX SOUND** is shown and the MAX SOUND button lights up.
 - If deactivated, "MAX OFF" is displayed and the MAX button black out.

VAC (Virtual Ambience Control)

The VAC feature enables you to adjust the system to select a type of environment.

- Press **VAC** to select : CINEMA, HALL or CONCERT.
 - The selected VAC is shown.

DSC (Digital Sound Control)

The DSC feature enables you to enjoy special sound effects that have preset equaliser settings, providing the best music reproduction.

- ① Press **DSC** to select : OPTIMAL, JAZZ, ROCK or TECHNO.
 - The selected DSC is shown.

DBB (Dynamic Bass Boost)

There are three DBB settings to enhance the bass response.

- ① Press **DBB** to select : DBB 1, DBB 2, DBB 3 or DBB OFF.
 - The selected **DBB** is shown, except for DBB OFF mode.

Automatic DSC-DBB selection

The best DBB setting is generated automatically for each DSC selection. You can manually select the DBB setting that best suits your listening environment.

DSC	DBB
JAZZ	off
ROCK	on (2)
TECHNO	on (3)
OPTIMAL	on (1)

Incredible Surround

The Incredible Surround magnifies the virtual distance between the front speakers for an incredibly wide, enveloping, stereo effect.

- Press and hold **DBB•INC SURR** (or **DBB/IS** on the remote control) until "INCR SUR" is displayed.
 - If activated, "INC SURR" is displayed.
 - If deactivated, "IS OFF" is displayed.

Note:

– Some discs might be recorded in high modulation, which causes a distortion at high volume. If this occurs, switch off DBB or reduce the volume.

Karaoke

Connecting a microphone (not supplied) to the system allowing you to sing along with the music source.

- ① Connect microphone(s) to the **MIC 1/2** jack.
- Before connecting the microphone, set the microphone **MIC VOLUME** to the minimum level to prevent howling sound.
- ② Press **DISC (CD 1/2/3)**, **TUNER**, **USB** or **AUX** to select the source to be mixed and start playback.
- ③ Adjust the volume level of the source with **MASTER VOLUME** control.
- ④ Adjust the microphone volume with the microphone **MIC VOLUME** control.
- ⑤ Adjust the echo level with the **ECHO** control.

Note:

– Keep the microphone away from the speakers to prevent howling.

CD/MP3-CD Operations

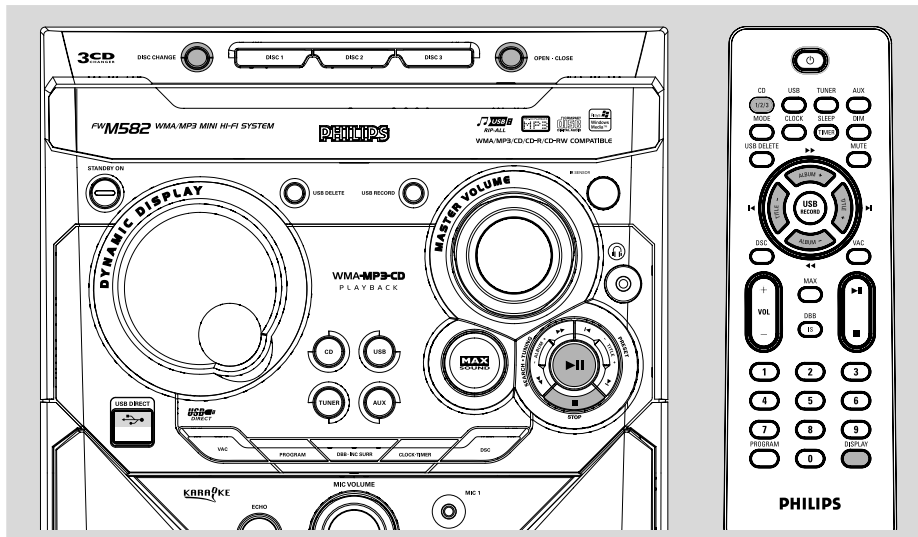

English

IMPORTANT!

- This system is designed for regular discs. Therefore, do not use any accessories such as disc stabiliser rings or disc treatment sheets, etc., as offered on the market, because they may jam the changer mechanism.
- Do not load more than one disc into each tray.

Discs for playback

This system can playback all digital audio CD, finalised digital audio CD-Recordable (CDR) discs and finalised digital audio CD-Rewritable (CDRW) discs.
MP3-CDs (CD-ROMs with MP3 tracks)



About MP3 disc

Supported formats

- ISO9660, Joliet, Multisession
- Max. track number plus album is 255
- Max. nested directory is 8 levels
- The max. album number is 32
- The max. MP3 program track number is 40
- Supported VBR bit-rate
- Supported sampling frequencies for MP3 disc are: 32 kHz, 44.1 kHz, 48 kHz
- Supported Bit-rates of MP3 disc are: 32, 64, 96, 128, 192, 256 (kbps)

Loading discs

- 1 Press **OPEN•CLOSE** to open the disc tray.
- 2 Load up to two discs on the individual disc trays. To load the third disc, press **DISC CHANGE**.
→ The disc tray will rotate until the empty tray is ready for loading.

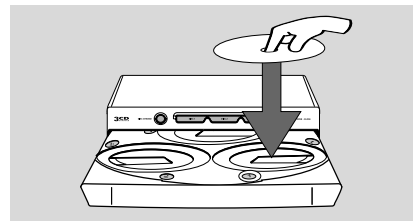

15

CD/MP3-CD Operations

- 3 Press **OPEN•CLOSE** to close the disc tray.
 - "READING DISC" scrolls. The selected disc tray, total number of tracks and the playing time will appear on the display.
 - A lighted button indicates that a disc is loaded on the disc tray.
 - For MP3 disc, the name of the first album and title will be scrolled through the display once and followed by "RXX X XXX".

Notes:

- Load the discs with the label side facing up.
- To ensure good system performance, wait until the disc tray completely reads the disc(s) before proceeding.
- For MP3 disc, the disc reading time may exceed 10 seconds due to the large number of songs compiled into one disc.

Playing discs

To play current disc on the disc tray

- Press **▶ II**.
 - The current discs will play once, then stop.
 - During playback, the selected disc tray, track number and elapsed playing time of the current track are displayed.
 - For MP3 disc, **TITLE** is shown. For mixed mode discs, only one mode will be selected for playback depending on the recording format.

To play the selected disc only

- In CD mode, press **DISC 1/2/3** (or **CD 1/2/3** on the remote control).
 - The selected disc will play once, then stop.

To interrupt playback

- Press **▶ II**.
 - The current track time flashes.
- To resume playback, press **▶ II** again.

To stop playback

- Press **STOP■**.

For MP3-CD

- During playback, press **DISPLAY** to show the album and title name.

Replacing discs during playback

- 1 Press **DISC CHANGE**.
 - The disc tray will open without interrupting current playback.
- 2 To change the inner disc, press **DISC CHANGE** again.
 - "CHANGING DISC" is displayed and the disc will stop playing.
 - The disc tray will close to retrieve the inner disc, then reopen with the inner disc accessible.

Selecting a desired track/passage

To search for a particular passage during playback

- Press and hold **ALBUM -/+ ◀▶** and release it when the desired passage is located.
 - During searching, the volume will be reduced.

To select a desired track

- Press **TITLE -/+ ◀▶** repeatedly until the desired track is displayed.
- If playback is stopped, press **▶ II** to start playback.

Selecting a desired Album/Title (MP3/WMA disc only)

To select a desired album

- Press **ALBUM -/+ ◀▶** repeatedly.
 - The album's name will scroll through the display once.

To select a desired title

- Press **TITLE -/+ ◀▶** repeatedly.
 - The title's name will scroll through the display once.

Note:

- The album and title will only be displayed once when selected. To view again, press the **DISPLAY** button repeatedly to display **ALBUM** and **TITLE** alternatively.



CD/MP3-CD Operations

Different play modes: SHUFFLE and REPEAT

You can select and change the various play modes before or during playback.

- 1 Press **MODE** on the remote control to select:
 - "REPEAT TRACK" – to repeat playback of the current track.
 - "REPEAT DISC" – to repeat playback of the current disc.
 - "REPEAT OFF" – to stop repeat function and playback current disc.
- To resume normal playback, press **MODE** until "REPEAT OFF" is displayed.
- 2 Press **MODE** on the remote control to select:
 - "SHUFFLE ON" – to random playback of the current disc.
 - "SHUFFLE OFF" – to stop shuffle function and playback current disc.
- To resume normal playback, press **Mode** "SHUFFLE OFF" is displayed.
 - **REP** or **SHUF** is shown, except SHUFFLE OFF mode.

Note:

– During program play mode or playing an MP3 CD, it is not possible to repeat playback of the current disc (Repeat Disc mode).

Programming the disc tracks

Programming tracks is possible when playback is stopped. Up to 40 tracks can be stored in the memory in any order.

- 1 Load the desired discs on the disc tray (refer to "Loading discs").
- 2 Press **DISC 1/2/3** to select a disc.
- 3 Press **PROGRAM** to start programming.
 - **PROG** starts flashing.
- 4 Press **TITLE +/-** repeatedly to select the desired track.
- For MP3 disc, press **ALBUM +/-** and **TITLE +/-** to select the desired album and title for programming.
- 5 Press **PROGRAM** to store the track.

- 6 To end programming, press **STOP** once.
 - **PROG** stays and the programme mode remains active.
 - The total number of tracks programmed and the total playing time are displayed.
 - For MP3 disc, total playing time will not be shown.
- 7 To start programme play, press **▶** .

Notes:

- It is not possible to create a programme with MP3 tracks from multiple CDs, or combined with normal audio tracks.
- If the total playing time is more than "99:59" then "--:--" is displayed instead of the total playing time.
- If you attempt to programme more than 40 tracks, "PROGRAM FULL" is displayed.
- During programming, if no button is pressed within 20 seconds, the system will exit the programme mode automatically.

To review the programme

- Stop playback and press **TITLE +/-** repeatedly.

Erasing the programme

- Press **STOP** once when playback is stopped or **twice** during playback.
 - **PROG** disappears and "PROGRAM CLEAR" is displayed.

Note:

– The programme will be erased when the system is disconnected from the power supply or when the disc tray is opened.



Radio Reception

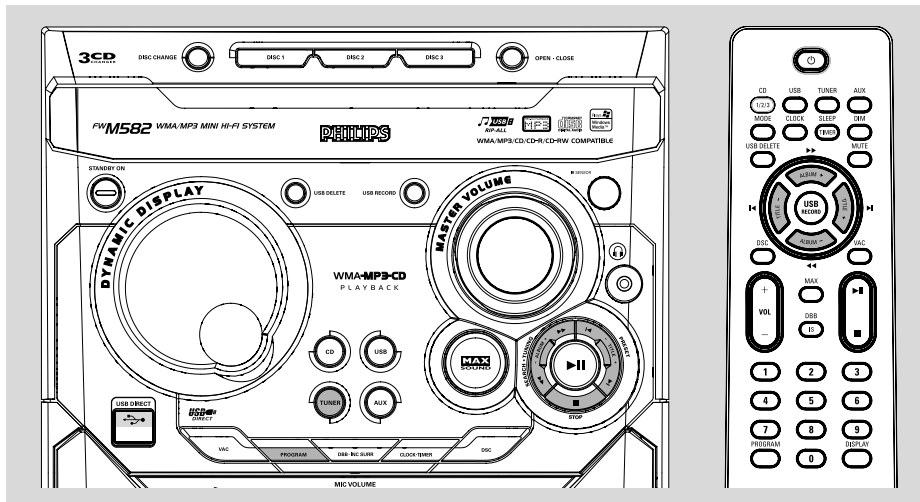

Tuning to radio stations

- 1 Press **TUNER** to select TUNER mode.
→ "TUNER" is displayed. A few seconds later, the current radio frequency will appear on the display.
- 2 Press **TUNER** again to select the desired waveband : FM or MW.
- 3 Press and hold **ALBUM -/+ <<>>** until the frequency indication starts to change, then release.
→ The display will show "SEARCH" until a radio station with sufficient signal strength is found.
- 4 Repeat step 3 if necessary until you find the desired radio station.
- To tune to a weak station, press **ALBUM -/+ <<>>** briefly and repeatedly until optimal reception found.

Storing preset radio stations

You can store up to 40 preset radio stations in the memory.

Automatic Preset Programming

- Plug and Play setting (refer to "Basic Functions - Plug and Play").
- OR

- 1 Press **TUNER** to select TUNER mode.

To begin automatic preset from a desired preset number

- Press **TITLE -/+ << / >> PRESET** to select the desired preset number.
→ If a radio station has been stored in one of the presets, it will not be stored again under another preset number.
- 2 Press and hold **PROGRAM** until "AUTO" is displayed.
→ **PROG** starts flashing.
→ All available radio stations with sufficient signal strength will be stored automatically, starting from FM and followed by MW band.
→ When all the available radio stations are stored or the memory for 40 presets are used, the last preset radio station will be played.

To stop storing the automatic preset

- Press **PROGRAM** or **STOP** on the system.

Note:

– If no preset number is selected, automatic preset will begin from preset (1) and all your former presets will be overridden.



Radio Reception

Manual Preset Programming

- 1 Tune to your desired radio station (refer to "Tuning to radio stations").
- 2 Press **PROGRAM**.
 - **PROG** starts flashing.
 - The next available preset number is displayed for selection.

To store the radio station to another preset number

- Press **TITLE +/-** **PRESET** to select the desired preset number.
- 3 Press **PROGRAM** again to store the radio station.
 - **PROG** disappears.
- Repeat **steps 1–3** to store other radio stations.

To exit manual preset mode

- Press **■** on the system.

Notes:

- If you attempt to store more than 40 preset radio stations, "FULL" is displayed.
- During programming, if no key is pressed within 10 seconds, the system will exit the programme mode automatically.

Tuning to preset radio stations

- Once you've programmed the radio stations, press **TITLE +/-** **PRESET** to select the desired preset number.
 - The preset number, radio frequency, and waveband are displayed.

Changing tuning grid *(not available for all versions)*

In North and South America, the frequency step between adjacent channels in the MW band is 10 kHz (9 kHz in some areas).

Changing the tuning grid will erase all previously stored preset radio stations.

- 1 Disconnect the system from the AC power supply (pull out the AC power cord).
- 2 While holding down **TUNER** and **▶▶** on the system, reconnect the system to the AC power supply.
 - The display will show "GRID 9" or "GRID 10".

Notes:

- GRID 9 and GRID 10 indicate that the tuning grid is in step of 9 kHz and 10 kHz respectively.
- The FM tuning grid also will be changed from 50 kHz to 100 kHz or vice versa.



External Sources

Connecting external equipment

- 1 Connect the audio out terminals of the external equipment (TV, VCR, Laser Disc player, DVD player or CD Recorder) to the **AUX** terminals of your system.
- 2 Press **AUX** to select external equipment.
→ "FLUX" is displayed.

Note:

- All the sound control features (DSC or DBB, for example) are available for selection.
- Refer to the operating instructions for the connected equipment for details.

Using a USB mass storage device

By connecting a USB mass storage device to the Hi-Fi system, you can enjoy the device's stored music through the powerful speakers of Hi-Fi system.

Playing a USB mass storage device Compatible USB mass storage devices

With the Hi-Fi system, you can use:

- USB flash memory (USB 2.0 or USB1.1)
- USB flash players (USB 2.0 or USB1.1)
- memory cards (requires an additional card reader to work with this Hi-Fi system)

Note:

- In some USB flash players (or memory devices), the stored contents are recorded using copyright protection technology. Such protected contents will be unplayable on any other devices (such as this Hi-Fi system).

– **Compatibility of the USB connection on this product:**

- a) This product supports most USB Mass storage devices (MSD) that are compliant to the USB MSD standards.
 - i) Most common Mass storage class devices are flash drives, memory sticks, jump drives and etc.
 - ii) If you see a "Disc Drive" show up on your computer after you plugged the mass storage device into your computer, most likely it is MSD compliant and it will work with this product.
- b) If your Mass storage device required a battery/power source. Please make sure you have a fresh battery in it or charge the USB device first and then plug it into the product again.

– **Supported Music type:**

- a) This device only supports unprotected music with the following file extension:
.mp3
.wma
 - b) Music bought from on-line music stores are not supported because they are secured by Digital Rights Management protection (DRM).
 - c) File name extensions that end with the following are not supported:
.wav; .m4a; .m4p; mp4; .aac and etc.
- **No Direct connection can be made from Computer USB port to the product even you have either or both mp3 or wma files in your computer.**

Supported formats:

- USB or memory file format FAT12, FAT16, FAT32 (sector size: 512 - 65,536 bytes)
- MP3 bit rate (data rate): 32-320 Kbps and variable bit rate
- WMA v9 or earlier
- Directory nesting up to a maximum of 8 levels
- Number of albums/ folders: maximum 99
- Number of tracks/titles: maximum 999
- ID3 tag v2.0 or later
- File name in Unicode UTF8 (maximum length: 128 bytes)

The system will not play or support the following:

- Empty albums: an empty album is an album that does not contain MP3/WMA files, and will not be shown in the display.
- Non-supported file formats are skipped. This means that e.g.: Word documents .doc or MP3 files with extension .dlf are ignored and will not be played.
- AAC, WAV, PCM audio files
- DRM protected WMA files
- WMA files in Lossless format

How to transfer music files from PC to a USB mass storage device

By dragging and dropping music files, you can easily transfer your favorite music from PC to a USB mass storage device.

For the flash player, you can also use its music management software for the music transfer.

However, those WMA files may be unplayable for compatibility reasons.



External Sources

How to organize your MP3/WMA files on the USB mass storage device

This Hi-Fi system will browse the MP3/WMA files in the folders/sub-folders/titles order.
Example:

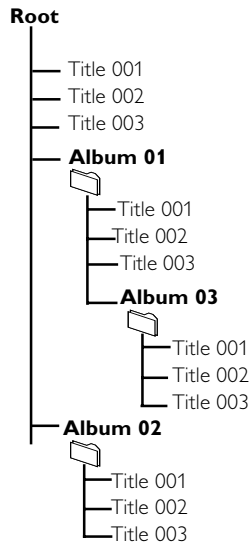

- 3 Play the USB's audio files as you do with the albums/tracks on a CD (See CD/MP3 Operations).

Notes:

- For compatibility reasons, the album/track information may differ from what it is displayed through flash players' music management software.
- File names or ID3 tags will be displayed as — if they are not in English.

Organize your MP3/WMA files in different folders or subfolders as required.

Notes:

- If you have not organized MP3/WMA files into any albums on your disc, an album "00" will be automatically assigned for all those files.
- Make sure that the file names of MP3 files end with `.mp3`, and the file names of WMA files end with `.wma`.
- For DRM protected WMA files, use Windows Media Player 10 (or later) for conversion. Visit www.microsoft.com for details about Windows Media Player and WM DRM (Windows Media Digital Rights Management).

- 1 Check the USB device has been properly connected. (See Installation: Connecting an additional appliance).
- 2 Press **USB** to select USB source.
 - **NO AUDIO** appears if no audio file is found in the USB device.

English



External Sources

Ripping function

This function enables you to record music to a connected USB mass storage device from any other source (i.e., DISC, TUNER, or AUX) without interrupting your enjoyment of the music.

- 1 Insert a USB mass device with sufficient free space to the **USB DIRECT**  socket on the set.
- 2 Prepare the source to record from.
DISC - load the disc(s). Select the disc to record from. Then, select a track where ripping will start (See "CD/MP3-CD Operations": "Selecting a desired track/passage" and "Selecting a desired Album/Title (MP3/WMA disc only)").
TUNER - tune to the desired radio station (See "Radio Reception": "Tuning to radio stations" and "Tuning to preset radio stations").
AUX - connect external equipment.
- 3 Press **USB RECORD** to start ripping.
 → "USB REC" will start flashing on the display.
 → In the DISC mode, "RIPPING ONE" will scroll once.
- In the DISC mode, to record all tracks starting from the one you selected, press **USB RECORD** again.
 → "RIPPING ALL" will scroll once. "ALL" and "USB REC" will start flashing on the display.
- 4 At any moment, simply press **STOP**  to stop ripping.

Notes:

- This function can also be combined with the programme function. In this case, selection of "RIPPING ALL" in DISC mode will record all programmed tracks from the starting point to the USB mass storage device.
- It is impossible to rip from "MIC IN".
- Never unplug the USB mass storage device before pressing **STOP**  to stop ripping.
- In the DISC mode, when you stop ripping or the free space is insufficient, the current track being ripped will not be recorded to your USB mass storage device and the playback will stop at the same time.
- During ripping, it is impossible to select any other source or track (radio station) or even switch the set to standby mode.

To delete a track/album from your USB mass storage device

- 1 Plug in the USB mass storage device.
- 2 Select the track/album to be deleted during playback.
- 3 Press **USB DELETE**.
 → "Delete track -- yes or no" is displayed for deleting a track.
 → "Delete album -- yes or no" is displayed for deleting an album.
- 4 Press **USB DELETE** again before "deleting" disappears to confirm the deletion.

External Sources

Tuner record timer setting

This function enables you to set a timer for starting and stopping ripping from the tuner source automatically.

IMPORTANT!

– Before setting the timer, ensure that the clock is set correctly.

- 1 Tune to the station you desire to record from. (See "Radio Reception", "Tuning to radio stations" and "Tuning to preset radio stations").
- 2 Go to the standby mode. Then, press and hold **CLOCK•TIMER** on the system for more than two seconds to select timer mode.
 - The last timer setting starts flashing.
 - The selected source will be lighted.
- 3 Press **TUNER** to select TUNER mode.
- 4 Press **USB RECORD** to enable USB recording.
 - "ST" appears. "USB REC" and the hour and minute digits for the start timer start flashing.
- To cancel USB record setting, press **USB RECORD** again until "ST" and "USB REC" disappear.
 - In this case, you can only continue to set the system switch-on timer. (See "Clock/Timer": "Timer setting".)
- 5 Press **ALBUM -/+ ◀▶** repeatedly to set the hour for the timer to start.
- 6 Press **TITLE -/+ ◀▶** repeatedly to set the minute for the timer to start.
 - "ET" appears. "z" and the hour and minute digits for the sleep timer (12 hours later than the start timer by default) start flashing.
- 7 Press **ALBUM -/+ ◀▶** repeatedly to set the hour for the timer to stop.
- 8 Press **TITLE -/+ ◀▶** repeatedly to set the minute for the timer to stop.
- 9 Press **CLOCK•TIMER** to store the set tuner record timer.
 - The ripping will start at the set start time and end at the set stop time.

Notes:

- It is impossible to set a sleep timer more than 12 hours later than the start timer.
- During timer setting, if no button is pressed within 60 seconds, the system will exit timer setting mode automatically.

To deactivate the TIMER

- Press **SLEEP/TIMER** on the remote control.
 -  disappears from the display.

To activate the TIMER

- Press **SLEEP/TIMER** on the remote control.
 -  appears on the display.

To view the set record timer

- 1 In the standby mode, press and hold **CLOCK•TIMER** on the remote control to view the start timer setting.
- 2 Press **CLOCK•TIMER** on the remote control again to view the sleep timer setting.

To view remaining time during ripping

- After the tuner record timer starts, press **SLEEP/TIMER** on the remote control to view the remaining time of ripping.
- To cancel the sleep timer; press **SLEEP/TIMER** repeatedly until "00" appears.

Clock/Timer

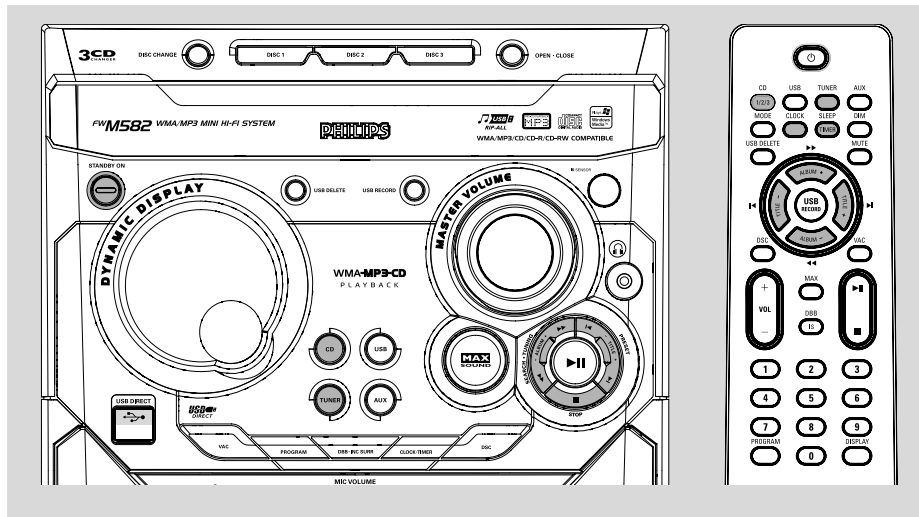

View clock

The clock (if it is set) will be shown in standby mode.

To view the clock in any source mode (CD or TUNER for example)

- Press **CLOCK•TIMER** (or **CLOCK** on the remote control).
 - The clock is displayed for a few seconds.
 - If the clock has not been set, "--:--" is displayed.

Clock setting

The clock can be set in 24-hour mode.

- 1 In standby or view clock mode, press **CLOCK•TIMER** (or **CLOCK** on the remote control) once. In other source mode, press **CLOCK•TIMER** (or **CLOCK** on the remote control) twice.
- 2 Press **ALBUM -/+ ◀▶** repeatedly to set the hour.
- 3 Press **TITLE -/+ ◀▶** repeatedly to set the minute.
- 4 Press **CLOCK•TIMER** (or **CLOCK** on the remote control) again to store the setting.
 - The clock starts working.

To exit without storing the setting

- Press **STOP ■** on the system.

Notes:

- The clock setting will be cancelled when the power cord is disconnected or if a power failure occurs.
- During clock setting, if no button is pressed within 10 seconds, the system will exit clock setting mode automatically.



Clock/Timer

Timer setting

The system can switch on to CD, TUNER, or USB mode automatically at a preset time, serving as an alarm to wake you up.

IMPORTANT!

- Before setting the timer, ensure that the clock is set correctly.
- The timer will always be switched on after it has been set.
- The timer will not start if a recording is in progress.
- The volume of the timer will increase gradually from the minimum level to the last tuned volume level.

- 1 In standby mode, press and hold **CLOCK•TIMER** for more than two seconds to select timer mode.
 - The last timer setting starts flashing.
 - The selected source will be lighted and flashing.
- 2 Press **CD**, **TUNER** or **USB** to select the desired source.
 - Before setting timer, make sure the music source has been prepared.
 - CD** – Load the disc(s). To start from a specific track, make a programme (refer to "CD Operation - Programming the disc tracks").
 - TUNER** – tune to the desired radio station.
- 3 Press **ALBUM -/+ ◀▶** repeatedly to set the hour for the timer to start.
- 4 Press **TITLE -/+ ◀▶** repeatedly to set the minute for the timer to start.
- 5 Press **CLOCK•TIMER** to store the start time.
 - At the preset time, the selected source will play.

To exit without storing the setting

- Press **STOP ■** on the system.

Notes:

- When the preset time is reached and the selected disc tray is empty, the next available disc will be selected. If all the disc trays are not available, Tuner will be selected automatically.
- During timer setting, if no button is pressed within 10 seconds, the system will exit timer setting mode automatically.

To deactivate the TIMER

- Press **SLEEP/TIMER** on the remote control.
 - The display will show "OFF" and **TIMER** will disappear from the display.

To activate the TIMER

- Press **SLEEP/TIMER** on the remote control.
 - The last set timer information will be shown for a few seconds and **TIMER** will appear on the display.

Sleep timer setting

The sleep timer enables the system to switch to standby mode automatically at a preset time.

- 1 In active mode, press **SLEEP/TIMER** on the remote control repeatedly to select a preset time.
 - The selections are as follows (time in minutes):
 - 15 → 30 → 45 → 60 → 90 → 120 → OFF
 - 15 ...
 - "SLEEP xx" or "SLEEP OFF" is displayed.
 - "xx" is the time in minutes.
- 2 When you reach the desired length of time, stop pressing the **SLEEP/TIMER** button.
 - **SLEEP** is shown, except for "SLEEP OFF" mode.

To check the remaining length of time after sleep timer is activated

- Press **SLEEP/TIMER** once.

To change the preset sleep timer

- Press **SLEEP/TIMER** again while the remaining sleep timer is shown.
 - The display will show the next sleep timer options.

To deactivate the sleep timer

- Press **SLEEP/TIMER** repeatedly until "SLEEP OFF" is displayed, or press **STANDBY ON ⏻**.

Specifications

AMPLIFIER

RMS output power	
LF channel	105 W per channel
HF channel	105 W per channel
Total Bi-Amp power	420 W
Signal-to-noise ratio	60 dBA (IEC)
Frequency response	50 – 15000 Hz
Input sensitivity	
AUX	900/2400 mV
Output	
Speakers	3 Ω
Headphones	32 Ω
(1) (3 Ω , 1 kHz, 10% THD)	

CD/MP3-CD PLAYER

Number of programmable tracks	99
Frequency response	50 – 20000 Hz -3dB
Signal-to-noise ratio	60 dBA
Channel separation	60 dBA (1 kHz)
Total harmonic distortion	< 0.003%
MPEG 1 Layer 3 (MP3-CD)	MPEG AUDIO
MP3-CD bit rate	32-256 kbps
	(128 kbps advised)
Sampling frequencies	32, 44.1, 48 kHz

TUNER

FM wave range	87.5 – 108 MHz
MW wave range (9 kHz)	531 – 1602 kHz
MW wave range (10 kHz)	530 – 1700 kHz
Tuning grid	9/10 kHz
Number of presets	40
Antenna	
FM	75 Ω wire
MW	Loop antenna

USB PLAYER

USB	12 Mb/s, V1.1
.....	support MP3 and WMA files
Number of albums/folders	maximum 99
Number of tracks/titles	maximum 400

SPEAKERS

System	2-way; double port bass reflex
Impedance	3 Ω
Woofer	1 x 5.5"
Tweeter	1 x 2"
Dimensions (w x h x d) ..	248 x 310 x 195 (mm)
Weight	3.65 kg each

GENERAL

Material/finish	Polystyrene/Metal
AC Power	110 – 127 / 220 – 240 V;
.....	50/60 Hz Switchable
Power Consumption	
Active	90 W
Standby	\leq 15 W
Dimensions (w x h x d) ..	265 x 310 x 367 (mm)
Weight (without speakers)	9.1 kg

Specifications and external appearance are subject to change without notice.



Maintenance

Maintenance

Cleaning the Cabinet

- Use a soft cloth slightly moistened with a mild detergent solution. Do not use a solution containing alcohol, spirits, ammonia or abrasives.

Cleaning Discs

- When a disc becomes dirty, clean it with a cleaning cloth. Wipe the disc from the centre out.
- Do not use solvents such as benzene, thinner, commercially available cleaners, or antistatic spray intended for analogue records.



Cleaning the disc lens

- After prolonged use, dirt or dust may accumulate at the disc lens. To ensure good playback quality, clean the disc lens with Philips CD Lens Cleaner or any commercially available cleaner. Follow the instructions supplied with cleaner.

Troubleshooting

WARNING

Under no circumstances should you try to repair the system yourself, as this will invalidate the warranty. Do not open the system as there is a risk of electric shock.

If a fault occurs, first check the points listed below before taking the system for repair. If you are unable to remedy a problem by following these hints, consult your dealer or Philips for help.

Problem	Solution
"NO DISC" is displayed.	<ul style="list-style-type: none"> ✓ Insert a disc. ✓ Check if the disc is inserted upside down. ✓ Wait until the moisture condensation at the lens has cleared. ✓ Replace or clean the disc, see "Maintenance". ✓ Use a finalized CD-RW or a correct MP3-CD format disc.
"DISC NOT FINALIZED" is displayed.	<ul style="list-style-type: none"> ✓ Use a finalised CD-RW or CD-R.
Some files on the USB device are not displayed.	<ul style="list-style-type: none"> ✓ Check if the number of folders exceeds 99 or the number of titles exceeds 400.

Troubleshooting

“DEVICE NOT SUPPORTED” scrolls on the display.

- ✓ Remove the USB mass storage device or select another source.

Radio reception is poor.

- ✓ If the signal is too weak, adjust the antenna or connect an external antenna for better reception.
- ✓ Increase the distance between the Mini HiFi System and your TV or VCR.

The system does not react when buttons are pressed.

- ✓ Remove and reconnect the AC power plug and switch on the system again.

Sound cannot be heard or is of poor quality.

- ✓ Adjust the volume.
- ✓ Disconnect the headphones.
- ✓ Check that the speakers are connected correctly.
- ✓ Check if the stripped speaker wire is clamped.
- ✓ Make sure the MP3-CD was recorded within 32-256 kbps bit rate with sampling frequencies at 48 kHz, 44.1 kHz or 32 kHz.

The left and right sound outputs are reversed.

- ✓ Check the speaker connections and location.

The remote control does not function properly.

- ✓ Select the source (CD or TUNER, for example) before pressing the function button (▶||).
- ✓ Reduce the distance between the remote control and the system.
- ✓ Insert the batteries with their polarities (+/- signs) aligned as indicated.
- ✓ Replace the batteries.
- ✓ Point the remote control directly towards the IR sensor.

The time is not working.

- ✓ Set the clock correctly.
- ✓ Press and hold **CLOCK • TIMER** to switch on the timer:
- ✓ If recording is in progress, stop recording.

Not all lighted buttons are showing light.

- ✓ Press **DIM** to select DIM OFF display mode.

The Clock/Timer setting is erased.

- ✓ Power has been interrupted or the power cord has been disconnected. Reset the clock/timer.

The system displays features automatically and buttons start flashing.

- ✓ Press and hold **■** on the system to switch off the demonstration.