

Register your product and get support at  
[www.philips.com/welcome](http://www.philips.com/welcome)

CID2680



---

ENG Quick Start Guide

---

**PHILIPS**

1

a

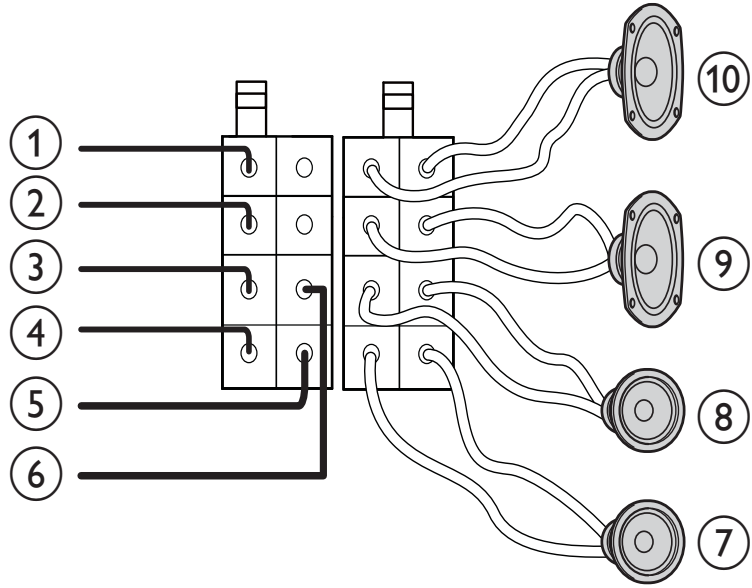

b

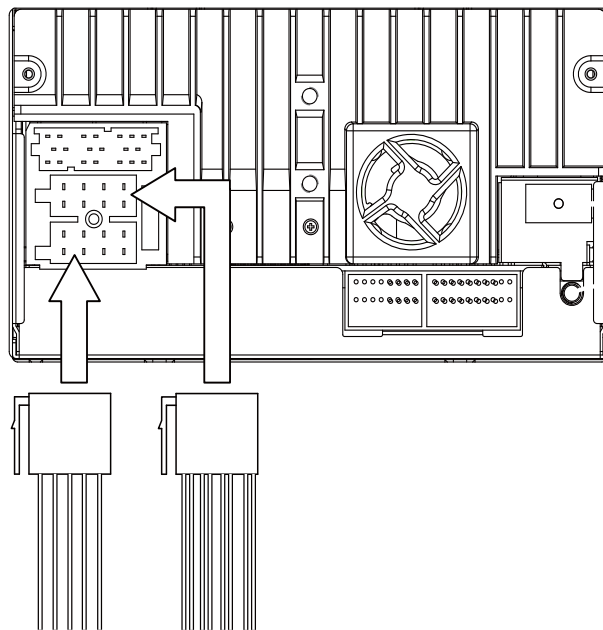

C

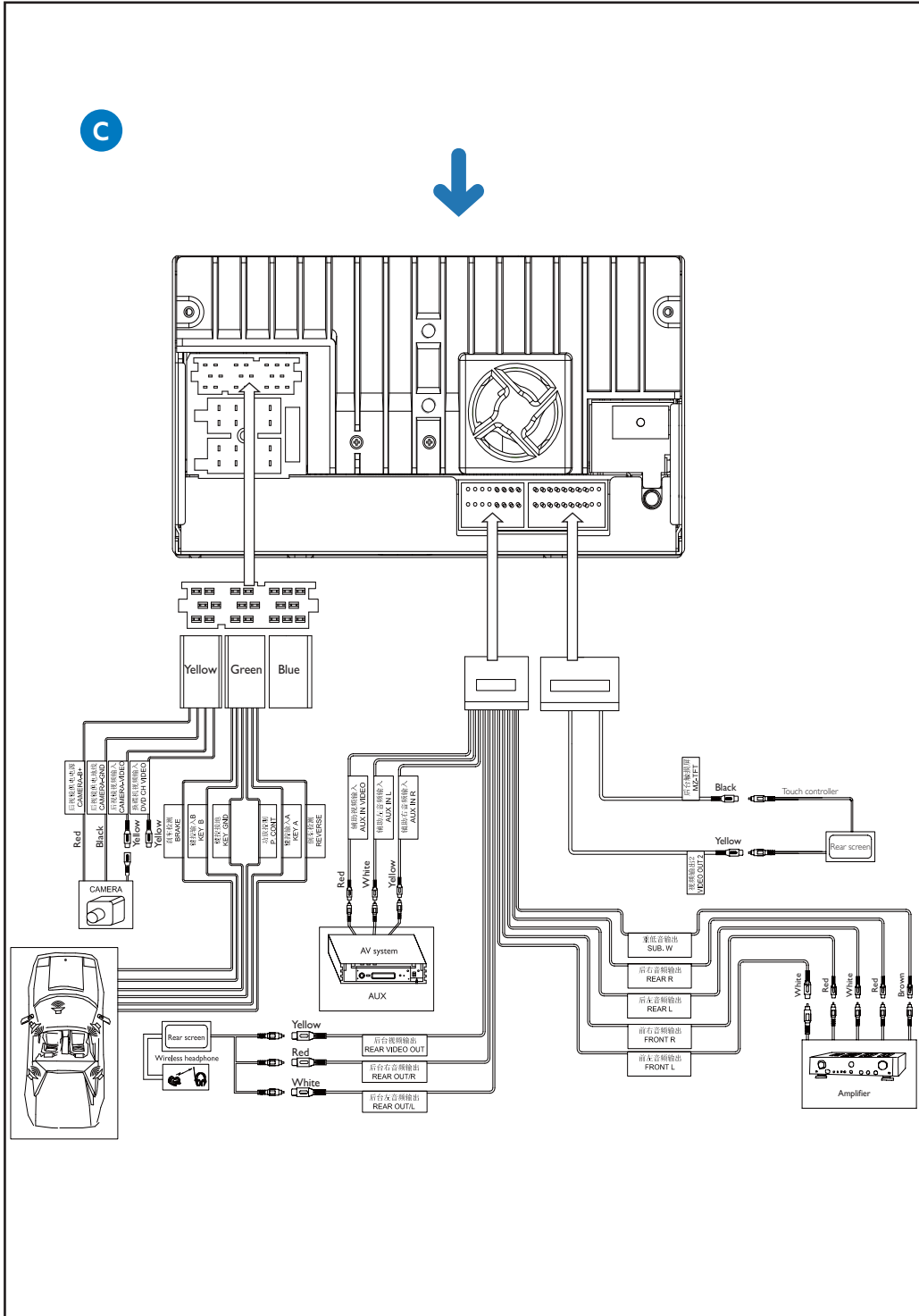

2

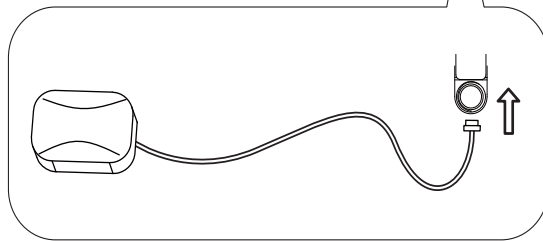
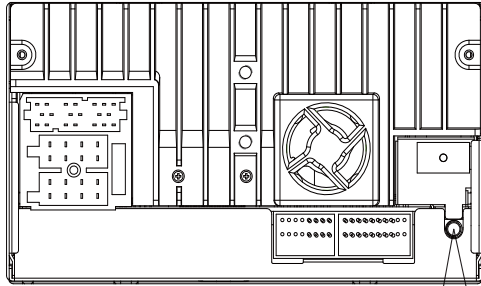

3

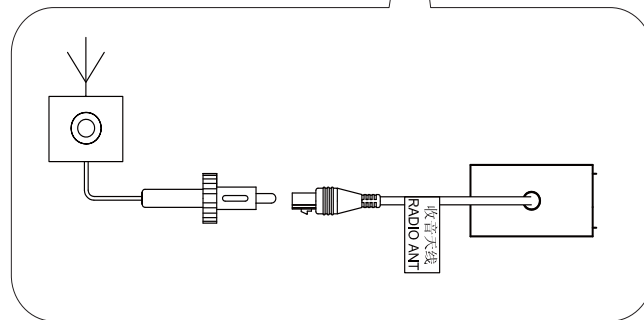
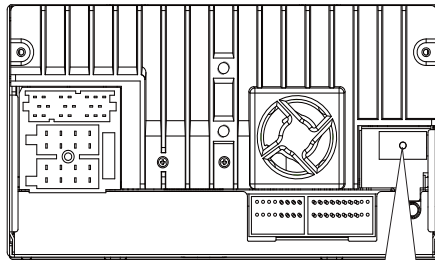

4

a

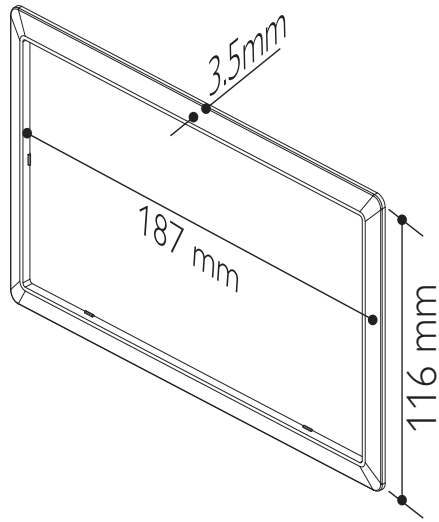

b

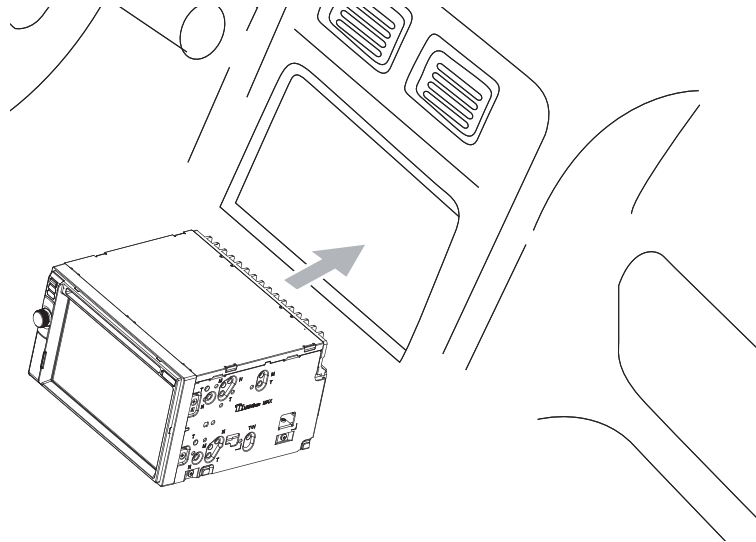

5

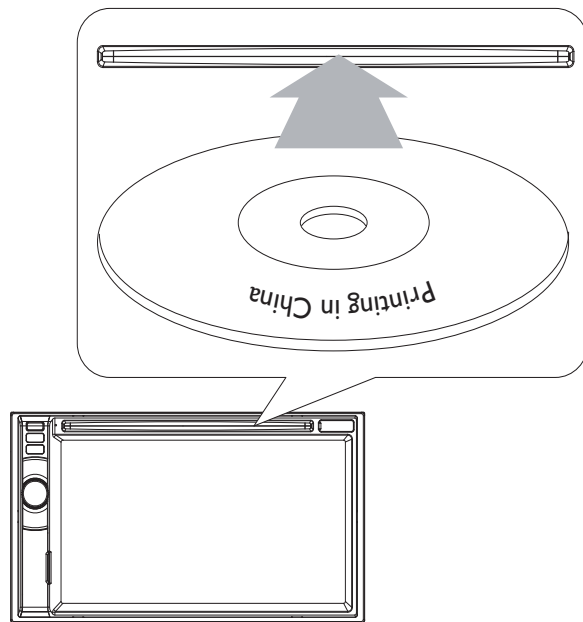

6

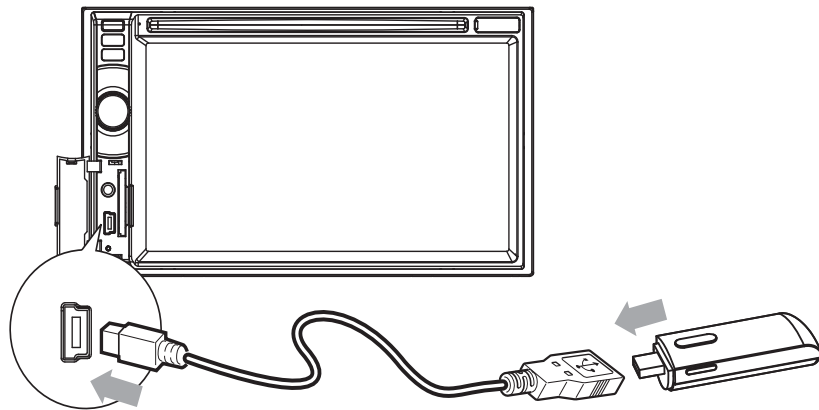

## Install the car audio

These instructions are for a typical installation. However, if your car has different requirements, make the corresponding adjustment. If you have any questions regarding installation kits, consult your Philips car audio dealer.

### ! Caution

- This unit is designed for negative ground (earth) 12 V DC operation only.
- Always install this unit in the car dashboard. Other locations can be dangerous as the rear of the unit heats up during use.
- To avoid short-circuit: before you connect, ensure that the ignition is off.
- Ensure that you connect the yellow and red power supply leads after all other leads are connected.
- Ensure that all loose leads are insulated with electrical tape.
- Ensure that the leads do not get caught under screws or in parts that will move (e.g. seat rail).
- Ensure that all ground (earth) leads are run to a common ground (earth) point.
- Use only the supplied mounting hardware for a safe and secure installation.
- Improper fuses can cause damage or fire. When you need to change the fuse, consult a professional.

### Note on the power supply lead (yellow)

- When you connect other devices to this system, ensure that the rating of the car circuit is higher than the total fuse value of all the connected devices.

### Notes on speaker connection

- Never connect speaker wires to the metal body or chassis of the car.
- Never connect speaker wires with stripes to one another.

## Connect wires 1

### ! Caution

- Ensure that all loose leads are insulated with electrical tape.

- 1 Check the car's wiring carefully, then connect them to the two supplied ISO wires. <sup>a</sup>

| Connector                     | Connect to  |
|-------------------------------|---|
| 1 Brown wire                  | Telephone mute  |
| 2 Red wire                    | <b>The +12V power terminal which is live in the accessory (ACC) position of the ignition switch</b><br>If there is no accessory position, connect to the +12V car battery terminal that is always live. Be sure to connect the black ground (earth) lead to a metal surface of the car first. |
| 3 Orange wire                 | Illumination switch   |
| 4 Black wire                  | <b>A metal surface of the car</b><br>First connect the black ground (earth) lead, then connect the yellow and red power supply leads.   |
| 5 Yellow wire                 | <b>The +12V car battery which is live at all times.</b>   |
| 6 Blue wire                   | <b>The electric antenna control lead or power supply lead of the antenna booster</b><br>If there is no electric antenna or antenna booster, or it is manually operated telescopic antenna, it is not necessary to connect this lead.  |
| 7 Green and green/black wires | <b>Left speaker (Rear)</b>  |

|    |                               |                       |
|----|-------------------------------|-----------------------|
| 8  | White and white/black wires   | Left speaker (Front)  |
| 9  | Gray and gray/black wires     | Right speaker (Front) |
| 10 | Purple and purple/black wires | Right speaker (Rear)  |

- 2 Connect the other end of the two ISO connectors to the car audio system. **b**
- 3 If necessary, do the other connections. **c**

### Connect GPS antenna **2**

To receive signal from satellite, you need to connect the supplied GPS antenna to your car and the system.

- 1 Connect the supplier GPS antenna to the system first.
- 2 Stick the other end of the GPS antenna to a metal surface of the car.

### Connect radio antenna **3**

If your car has built-in radio antenna, connect it to the radio antenna of the system for better radio signal.

- 1 Connect the radio antenna to the car antenna.

### Mount in the dashboard **4**

#### Note

- Check wire connection before you mount the unit into a car.
- If preset radio stations are lost when the ignition key is turned OFF and then back ON, reconnect the red leads crosswise to the yellow ones.

- 1 If the car does not have an on-board drive or navigation computer, disconnect the negative terminal of the car battery.
  - If you disconnect the car battery in a car that has an on-board drive or navigation computer, the computer may lost its memory.
  - If the car battery is not disconnected, to avoid short-circuit, ensure that bare wires do not touch each other.
- 2 Ensure that car dashboard opening is within these measurements: **a**
  - Since the unit cannot be used if the dashboard opening's slant angle is above 20 degrees: Ensure that the horizontal slant of the car dashboard opening is between 0 and 20 degrees.
- 3 Slide the unit into the dashboard until a click sound is heard. **b**
- 4 Attach the trim plate.
- 5 Reconnect the negative terminal of the car battery.

## Turn on

### ! Caution

- Risk of road accidents! Never watch video or adjust settings while you drive.

- 1 Press **⊕** to turn on the unit.
  - ↳ The available OSD (On-Screen Display) languages are displayed.



- 2 Touch a language to select.
  - ↳ The OSD language is changed to the selected language immediately.
- To adjust screen brightness/contrast, press on the remote control, then press , , or .
- To turn off the unit, press for 3 seconds.

## Set date and time

- 1 Touch the upper left corner to display main menu.
- 2 Touch in the middle right side of the screen.
  - ↳ The second main menu is displayed.
- 3 Touch **[Settings]**.
- 4 Touch **[Time]**.
  - ↳ The date/time setup menu is displayed.



### Set date

- 1 Touch **[Date]**.
- 2 Touch on the displayed date information.
  - ↳ A submenu is displayed.
- 3 Touch or to set year, month and day.

### Set clock mode

- 1 Touch **[Clock mode]**.
- 2 Touch on **[12Hr]** or **[24Hr]** to select clock mode.

### Set time

- 1 Touch **[Time]**.
- 2 Touch on the displayed time.
  - ↳ A submenu is displayed.
- 3 Touch or to set hour and minute.



#### Tip

- When date/time is set, touch first and then touch to return to main menu.

## Use map



#### Note

- You may need to upgrade the map before using it (see "Upgrade the map" section)

- 1 Touch the upper left corner to display home menu.
- 2 Touch **[Navigation]**.
  - ↳ The navigation menu is displayed in a few seconds.



- 3 Refer to the map manual (in Chinese) to operate the navigation tool.



#### Tip

- You can press **NAVI** to enter/exit the navigation system.

---

## Tune to a radio station

- 1 Touch the upper left corner to display home menu.
- 2 Touch **[Radio]**.  
↳ Band and frequency information is displayed.



- 3 Touch on **FM** or **AM** to select band:
  - FM band options: **FM1, FM2, FM3**
  - AM band options: **AM1, AM2**
- 4 Briefly touch ◀ or ▶ to tune to a radio station by step.
  - Touch ◀ or ▶ for over 1 seconds to tune to a radio station automatically.

---

## Load discs 5

You can play video, audio or images stored on the following discs:

- DVD video, DVD-R, DVD-RW
- VCD
- Audio CD, CD-R, CD-RW

### Note

- Ensure that the disc contains playable content.

- 1 Insert the disc into the disc slot with label side facing up.
  - ↳ Play starts automatically.
  - ↳ To remove the disc, press the ▲ button.
    - ↳ When the disc is ejected, the unit switches to the previous source, if connected. Otherwise, the unit switches to **[Radio]** mode automatically.

---

## Connect USB device 6

### Note

- Ensure that the device contains playable content.

- 1 Open the USB door.
- 2 Insert the small end of the supplied USB cable to the USB socket, then connect the other end of the USB cable to your USB device.
  - ↳ Play starts automatically.

---

## Pair the Bluetooth-enabled devices

To connect your Bluetooth device to the unit, you need to pair the device to the unit. Pairing needs only to be done once. You can pair up to eight devices.

- 1 Turn on the Bluetooth function on the device.
- 2 Search for Bluetooth device with the device.
- 3 Select "CID2680" in the pairing list.
- 4 Enter default password "0000".
  - ↳ If the pairing succeeds, phone call record is displayed.



---

## Make a call

- 1 Pair the phone with the unit.
- 2 Touch the upper left corner to display the home menu.

- 3 Touch **[Bluetooth]**.  
↳ The Bluetooth menu is displayed.



- 4 Touch ▲ or ▼ to select the paired phone, then touch .
- 5 Touch ▲ or ▼ to search for phone number from the following list:



Or touch to dial number directly, then touch to dial.

## Receive call

By default, all incoming calls are received automatically.

- 1 If there is incoming call, **[Incoming call...]** flashes on the screen. Speak into the Bluetooth microphone.

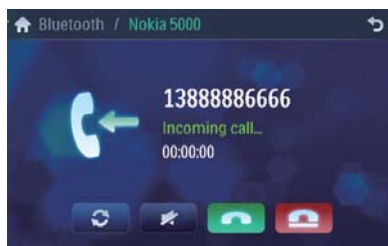

- 2 When conversation ends, touch (red) to terminate the call.

### Tip

- You can select to receive calls manually by set **[Auto answer]** to **[Off]** status.

## Adjust sound

### Adjust volume

- 1 Turn clockwise to increase volume.
  - Turn anti-clockwise to reduce volume.

### Mute

- 1 During play, press .
  - To turn the sound back on, press again.

### Tip

- You can also turn off sound by touching on the screen.

## Select preset equalizer

You can select preset equalizer:

- 1 Touch anywhere except for the upper left corner to display menu on the screen, if necessary.
- 2 Touch .  
↳ The current Equalizer setting is displayed.



- 3 Touch ◀ or ▶ to select an EQ.
- 4 Touch ▲ or ▼ to adjust below settings:
  - [Bass]bass range: -14 to +14.
  - [Mid]middle range: -14 to +14.
  - [Treb]treble range: -14 to +14
  - [LPH] low pass filter range: 60, 80, 100, 200.
  - [MPF]middle pass filter range: 500, 1K, 1.5K, 2.5K.
  - [HPF]high pass filter range:10K, 12.5K, 15K, 17.5K.
- 5 Touch ⏪ to restore the above settings into default settings.
- 6 Press ↵ to exit.



© 2009 Koninklijke Philips Electronics N.V.

All rights reserved.

CID2680\_93\_QSG\_V1.0