

Register your product and get support at
www.philips.com/welcome

DVP3986K



EN	DVD Video Player	6
ZH_CN	DVD播放机	56

PHILIPS

部件名称 Name of the Parts	有毒有害物质或元素 Hazardous/Toxic Substance					
	铅 (Pb, Lead)	汞 (Hg, Mercury)	镉 (Cd, Cadmium)	六价铬 (Chromium 6+)	多溴联苯 (PBB)	多溴二苯醚 (PBDE)
Housing 外壳	O	O	O	O	O	O
DVD loader DVD 光盒	X	O	O	O	O	O
PWBs 电路板组件	X	O	O	O	O	O
Accessories (Remote control & cables) 附件 (遥控器, 电源线, 连接线)	X	O	O	O	O	O
Batteries in Remote Control (ZnC) 遥控器电池	X	O	O	O	O	O

O: 表示该有毒有害物质在该部件所有均质材料中的含量均在SJ/T11363 - 2006 标准规定的限量要求以下。
O: Indicates that this toxic or hazardous substance contained in all of the homogeneous materials for this part is below the limit requirement in SJ/T11363 - 2006.

X: 表示该有毒有害物质至少在该部件的某一均质材料中的含量超出SJ/T11363 - 2006 标准规定的限量要求。
X: Indicates that this toxic or hazardous substance contained in at least one of the homogeneous materials used for this part is above the limit requirement in SJ/T11363 - 2006.



环保使用期限 **Environmental Protection Use Period**

此标识指期限 (十年), 电子信息产品中含有的有毒有害物质或元素在正常使用的条件下不会发生外泄或突变, 用户使用该电子信息产品不会对环境造成严重污染或对其人身、财产造成严重损害的期限。

This logo refers to the period (10 years) during which the toxic or hazardous substances or elements contained in electronic information products will not leak or mutate so that the use of these [substances or elements] will not result in any severe environmental pollution, any bodily injury or damage to any assets.

电池标识 **Battery labeling logo**



环保使用期限 **Environmental Protection Use Period**

此标识指期限 (五年), 电池中含有的有毒有害物质或元素在正常使用的条件下不会发生外泄或突变, 用户使用该电池产品不会对环境造成严重污染或对其人身、财产造成严重损害的期限。

This logo refers to the period (5 years) during which the toxic or hazardous substances or elements contained in the **battery** will not leak or mutate so that the use of these [substances or elements] will not result in any severe environmental pollution, any bodily injury or damage to any assets.

LASER

Type	Semiconductor laser InGaAlP (DVD) AlGaAs (CD)
Wave length	658 nm (DVD) 790 nm (CD)
Output Power	7.0 mW (DVD) 10.0 mW (VCD/CD)
Beam divergence	60 degrees

Due to the inconsistency of disc formats provided by various disc manufacturers, your DVD system/ player/recorder may require a playability enhancement or upgrade. As DVD technology advances, these enhancement will become common and will be easy to complete. Go to www.philips.com/support for software upgrade.

'CONSUMERS SHOULD NOTE THAT NOT ALL HIGH DEFINITION TELEVISION SETS ARE FULLY COMPATIBLE WITH THIS PRODUCT AND MAY CAUSE ARTIFACTS TO BE DISPLAYED IN THE PICTURE. IN CASE OF 525 OR 625 PROGRESSIVE SCAN PICTURE PROBLEMS, IT IS RECOMMENDED THAT THE USER SWITCH THE CONNECTION TO THE 'STANDARD DEFINITION' OUTPUT. IF THERE ARE QUESTIONS REGARDING OUR TV SET COMPATIBILITY WITH THIS MODEL 525p AND 625p DVD PLAYER, PLEASE CONTACT OUR CUSTOMER SERVICE CENTER.'

The apparatus shall not be exposed to dripping or splashing and that no objects filled with liquids, such as vases, shall be placed on apparatus.

ATTENTION!

For Customer Use:

Read carefully the information located at the bottom or rear of your DVD Video player and enter below the Serial No. Retain this information for future reference.

Model No. DVP3986K

Serial No. _____

Laser Safety

This unit employs a laser. Due to possible eye injury, only a qualified service person should remove the cover or attempt to service this device.

NOTE:
Pictures shown maybe different between countries.

CAUTION:
WARNING LOCATION: ON THE BACKPLATE OF THE SET

NEVER MAKE OR CHANGE CONNECTIONS WITH THE POWER SWITCHED ON.

Where the MAINS plug or an appliance coupler is used as the disconnect device, the disconnect device shall remain readily operable.

通过此网站注册您的产品并获得支持：
www.philips.com/welcome

This product incorporates copyright protection technology that is protected by method claims of certain U.S. patents and other intellectual property rights owned by Macrovision Corporation and other rights owners. Use of this copyright protection technology must be authorized by Macrovision Corporation, and is intended for home and other limited viewing uses only unless otherwise authorized by Macrovision Corporation. Reserve engineering or disassembly is prohibited.

Language Code

Abkhazian	6566	Inupiaq	7375	Pushto	8083
Afar	6565	Irish	7165	Russian	8285
Afrikaans	6570	Íslenska	7383	Quechua	8185
Amharic	6577	Italiano	7384	Raeto-Romance	8277
Arabic	6582	Ivrit	7269	Romanian	8279
Armenian	7289	Japanese	7465	Rundi	8278
Assamese	6583	Javanese	7486	Samoan	8377
Avestan	6569	Kalaallisut	7576	Sango	8371
Aymara	6589	Kannada	7578	Sanskrit	8365
Azerhijani	6590	Kashmiri	7583	Sardinian	8367
Bahasa Melayu	7783	Kazakh	7575	Serbian	8382
Bashkir	6665	Kernewek	7587	Shona	8378
Belarusian	6669	Khmer	7577	Shqip	8381
Bengali	6678	Kinyarwanda	8287	Sindhi	8368
Bihari	6672	Kirghiz	7589	Sinhalese	8373
Bislama	6673	Komi	7586	Slovensky	8373
Bokmål, Norwegian	7866	Korean	7579	Slovenian	8376
Bosanski	6683	Kuanyama; Kwanyama	7574	Somali	8379
Brezhoneg	6682	Kurdish	7585	Sotho; Southern	8384
Bulgarian	6671	Lao	7679	South Ndebele	7882
Burmese	7789	Latina	7665	Sundanese	8385
Castellano, Español	6983	Latvian	7686	Suomi	7073
Catalán	6765	Letzeburgesch;	7666	Swahili	8387
Chamorro	6772	Limburgan; Limburger	7673	Swati	8383
Chechen	6769	Lingala	7678	Svenska	8386
Chewa; Chichewa; Nyanja	7889	Lithuanian	7684	Tagalog	8476
中文	9072	Luxembourgish;	7666	Tahitian	8489
Chuang; Zhuang	9065	Macedonian	7775	Tajik	8471
Church Slavick; Slavonic	6785	Malagasy	7771	Tamil	8465
Chuvash	6786	Magyar	7285	Tatar	8484
Corsican	6779	Malayalam	7776	Telugu	8469
Česky	6783	Maltese	7784	Thai	8472
Dansk	6865	Manx	7186	Tibetan	6679
Deutsch	6869	Maori	7773	Tigrinya	8473
Dzongkha	6890	Marathi	7782	Tonga (Tonga Islands)	8479
English	6978	Marshallese	7772	Tsonga	8483
Esperanto	6979	Moldavian	7779	Tswana	8478
Estonian	6984	Mongolian	7778	Türkçe	8482
Euskara	6985	Nauru	7865	Turkmen	8475
Ελληνικά	6976	Navaho; Navajo	7886	Twi	8487
Faroese	7079	Ndebele, North	7868	Uighur	8571
Français	7082	Ndebele, South	7882	Ukrainian	8575
Frysk	7089	Ndonga	7871	Urdu	8582
Fijian	7074	Nederlands	7876	Uzbek	8590
Gaelic; Scottish Gaelic	7168	Nepali	7869	Vietnamese	8673
Gallegan	7176	Norsk	7879	Volapuk	8679
Georgian	7565	Northern Sami	8369	Walloon	8765
Gikuyu; Kikuyu	7573	North Ndebele	7868	Welsh	6789
Guarani	7178	Norwegian Nynorsk;	7878	Wolof	8779
Gujarati	7185	Occitan; Provençal	7967	Xhosa	8872
Hausa	7265	Old Bulgarian; Old Slavonic	6785	Yiddish	8973
Herero	7290	Oriya	7982	Yoruba	8979
Hindi	7273	Oromo	7977	Zulu	9085
Hiri Motu	7279	Ossetian; Ossetic	7983		
Hrwatski	6779	Pali	8073		
Ido	7379	Panjabi	8065		
Interlingua (International)	7365	Persian	7065		
Interlingue	7365	Polski	8076		
Inuktitut	7385	Português	8084		



Manufactured under license from Dolby Laboratories. Dolby and the double-D symbol are trademarks of Dolby Laboratories.



Manufactured under license under U.S. Patent#: 5,451,942 & other U.S. and worldwide patents issued & pending. DTS and DTS Digital Out are registered trademarks and the DTS logos and Symbol are trademarks of DTS, Inc. @ 1996-2007 DTS, Inc. All Rights Reserved.



Windows Media and the Windows logo are trademarks, or registered trademarks of Microsoft Corporation in the United States and/or other countries.



DivX, DivX Ultra Certified, and associated logos are trademarks of DivX, Inc. and are used under license.



HDMI and HDMI logo and High-Definition Multimedia Interface are trademarks or registered trademarks of HDMI licensing LLC.

English 6

中文(简体) 56

English

中文(简体)

Table of contents

General

General Information	8
Setup precautions.....	8
Accessories supplied	8
Cleaning discs	8
About recycling.....	8

Product Overview

Your DVD Player	9
Remote Control	10-12
Using the remote control.....	12

Connections

Basic Connections	13-15
Step 1: Connecting to television	13-14
Option 1: Using Composite Video jacks (CVBS).....	13
Option 2: Using Component Video jacks (Y Pb Pr).....	13
Option 3: Using HDMI or DVI TV jack	14
Step 2: Connecting the power cord.....	15
Optional Connections	16-17
Connecting to a Multi Channel Receiver.....	16
Connecting to an Analog Stereo System.....	16
Connecting to a Digital AV Amplifier/Receiver.....	17

Basic Setup

Getting Started	18-21
Finding the correct viewing channel	18
Setting language preferences.....	18-19
On-screen display (OSD) language.....	18
Audio, Subtitle and Menu language for DVD playback.....	19
Setting up Progressive Scan feature.....	20
Setting the EasyLink control	21
One touch control.....	21

Disc Playback

Disc Operations	22-33
Playable discs	22
Region codes for DVD discs	22
Playing a disc	23
Basic playback controls.....	23-24
Other playback features for video discs.....	24-25
Using the Disc Menu	24
Zooming.....	25
Changing sound track language.....	25
Changing subtitle language	25
Playback Control (VCD/SVCD).....	25

Table of contents

Using Display menu options.....	26-28
Selecting title/chapter/track.....	26
Searching by time.....	26
Viewing playing time.....	27
Switching camera angles.....	27
Preview function (VCD/SVCD/DVD).....	27
Selecting various repeat functions.....	28
Repeating a specific section (A-B).....	28
Special Audio CD feature.....	29
Playing a DivX® disc.....	30
Playing a JPEG photo disc (slide show).....	31
Preview function.....	31
Zooming.....	31
Flip/Rotate picture.....	31
Playing a MP3/ WMA disc.....	32
Playing music and photo files simultaneously.....	33
Karaoke Operation.....	34
Playing a Karaoke disc.....	34
Using the Karaoke Menu option.....	34

Setup Options

Setup Menu Options.....	35-47
Accessing the setup menu.....	35
General Setup Page.....	36-37
Audio Setup Page.....	38-41
Video Setup Page.....	42-45
Preference Page.....	46-47

Others

Software upgrade.....	48
Installing the latest software.....	48
Troubleshooting.....	49-51
Specifications.....	52
Glossary.....	53-54

General Information

WARNING!

This unit does not contain any user-serviceable parts. Please leave all maintenance work to qualified personnel.

Setup precautions

Finding a suitable location

- Place this unit on a flat, hard and stable surface. Never place the unit on a carpet.
- Never place this unit on top of other equipment that might heat it up (e.g., receiver or amplifier).
- Never put anything under this unit (e.g., CDs, magazines).
- Install this unit near the AC outlet where the AC power plug can be easily reached.

Space for ventilation

- Place this unit in a location with adequate ventilation to prevent internal heat build up. Allow at least 10 cm (4") clearance from the rear and the top of this unit and 5 cm (2") from the left and right to prevent overheating.

Avoid high temperature, moisture, water and dust

- This unit must not be exposed to dripping or splashing.
- Never place any object or items that can damage this unit (e.g., liquid filled objects, lighted candles).

Accessories supplied

- 1 remote control with batteries
- 1 audio/video cables (yellow/white/red)

Cleaning discs

CAUTION!

Risk of damage to discs! Never use solvents such as benzene, thinner, cleaners available commercially, or anti-static sprays intended for discs.

- Wipe the disc with a micro fibre cleaning cloth from the center to the edge in a straight line movement.

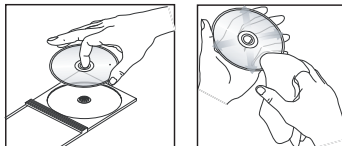

About recycling

This user manual is printed on non-polluting paper. This unit contains a large number of materials that can be recycled. If you are disposing an old equipment, please take it to a recycling center. Please observe the local regulations regarding disposal of packaging materials, exhausted batteries and old equipment.

Your DVD Player

English

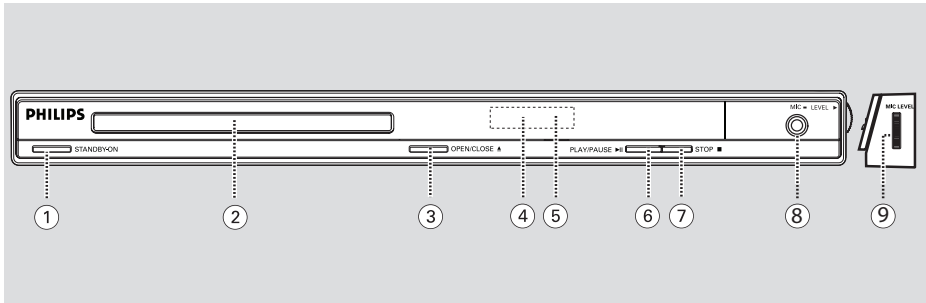

① **STANDBY-ON**

- Turns on this unit or turns off to normal standby mode.

② **Disc tray**

③ **OPEN/CLOSE ▲**

- Opens/closes the disc tray.

④ **Display panel**

- Show information about the current status of this unit.

⑤ **IR Sensor**

- Point the remote control towards this sensor.

⑥ **PLAY/PAUSE ►||**

- Starts/pauses playback.

⑦ **STOP ■**

- Stops playback.

⑧ **MIC**

- For microphone connection.

⑨ **MIC LEVEL**

- Microphone volume control.

Remote Control

English

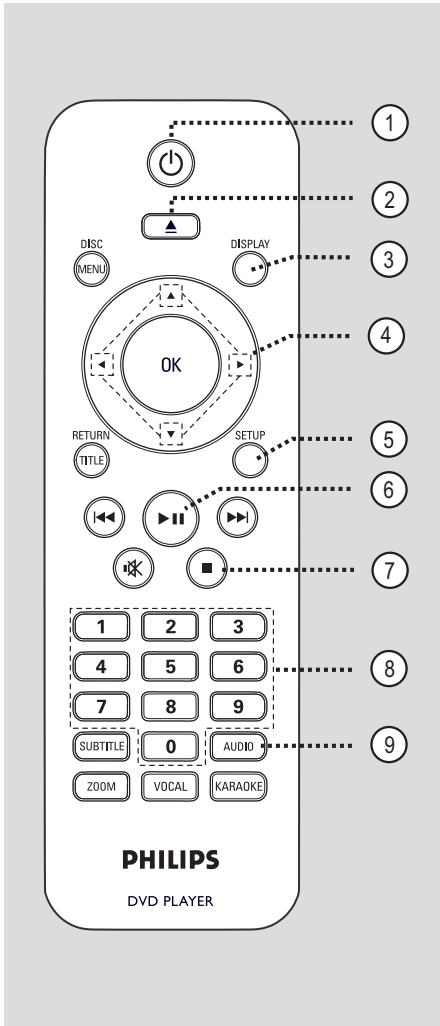

- ① **Power**
 - Turns on this unit or turns off to normal standby mode.
- ② **▲ (Open/Close)**
 - Opens/closes the disc tray.
- ③ **DISPLAY**
 - Displays the current status or disc information.
- ④ **▲▼◀▶**
 - **▲▼**: Move cursor to up or down.
: Press up or down for a slow forward or backward search.
 - **◀▶**: Move cursor to left or right.
: Press left or right for fast forward or backward search.
- ⑤ **SETUP**
 - Enters or exits the disc setup menu.
- ⑥ **▶|| (Play/Pause)**
 - Starts or pauses playback.
- ⑦ **■ (Stop)**
 - Stops playback.
- ⑧ **Numeric keypad 0-9**
 - Selects a track or title number of the disc.
- ⑨ **AUDIO**
 - Selects an audio language or channel.

Remote Control (continued)

⑩ DISC MENU

- Enters or exits disc contents menu.
- For VCD 2.0 and SVCD, switches on or off the playback control mode.

⑪ OK

- Confirms an entry or selection.

⑫ RETURN/TITLE

- Returns to the previous menu or shows title menu.

⑬ ◀◀ / ▶▶ (Previous/Next)

- Skips to the previous or next title/ chapter/track.
- Press and hold this button for fast forward or backward search.

⑭ 🔇 (Mute)

- Mutes or restores the volume.

⑮ SUBTITLE

- Selects a DVD subtitle language.

⑯ ZOOM

- Zoom the picture on the TV.

⑰ VOCAL

- Choose audio channel or karaoke method.

KARAOKE

- Toggles between 'MIC', 'Vol', 'Echo', 'Key' or 'Karaoke Scoring'.

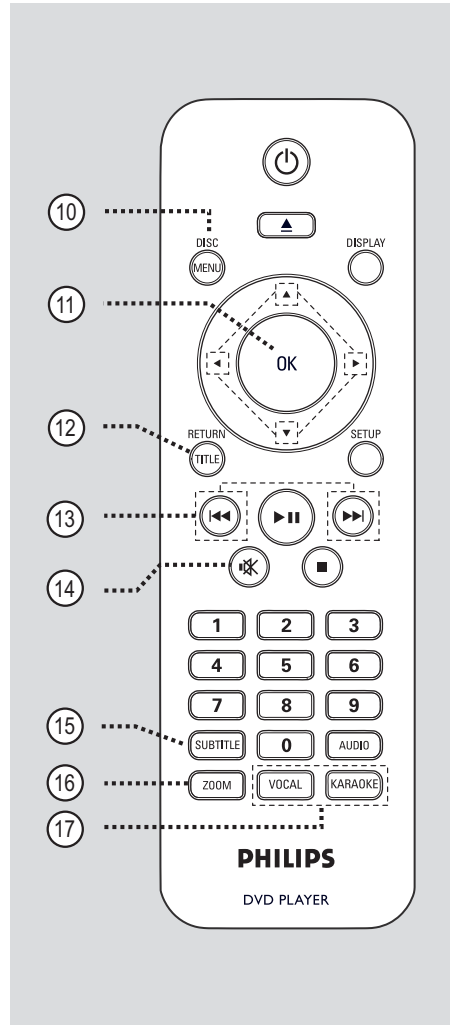

Remote Control (continued)

Using the remote control

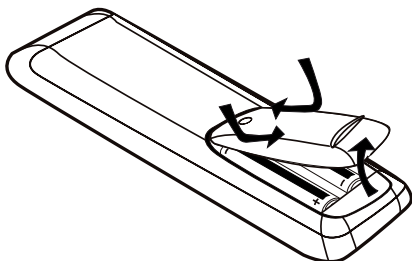

- 1 Open the battery compartment.
- 2 Insert two batteries type R03 or AAA, following the indications (+ -) inside the compartment.
- 3 Close the cover.
- 4 Point the remote control directly at the remote sensor (IR) on the front panel.

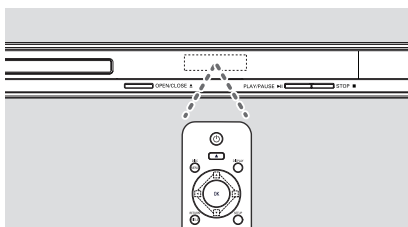

Note:

Never place any objects between the remote control and this unit while operating.

- 5 Select the desired function (for example ►II).

CAUTION!

- Remove batteries if they are exhausted or if the remote control is not to be used for a long time.
- Never mix batteries (old and new or carbon and alkaline, etc.).
- Batteries contain chemical substances; they should be disposed of properly.

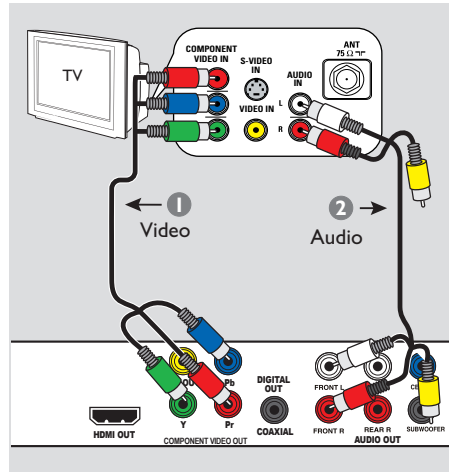
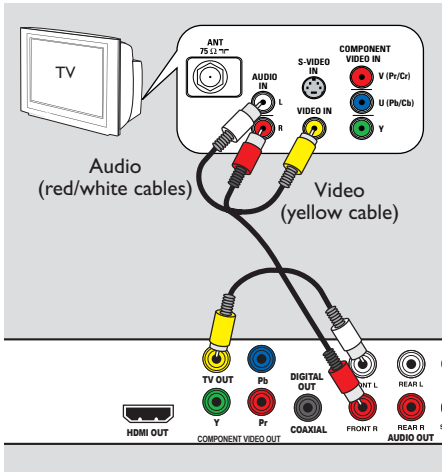

Step 1: Connecting to television

This connection enables you to view the video playback from this unit. You only need to choose **one** of the options below to make the video connection.

- For a standard TV, follow option 1.
- For a progressive scan TV, follow option 2.
- For a HDMI TV, follow option 3.

Option 1: Using Composite Video jacks (CVBS)

You can connect this unit to a TV through the composite video cable which provides good picture quality.

- Connect the audio/video cables (supplied) from the **TV OUT** and **AUDIO OUT FRONT L/R** jacks on this unit to the video input jack (yellow) and audio input jacks (red/ white) on your TV.

Option 2: Using Component Video jacks (Y Pb Pr)

You can connect this unit to a TV through the component video cables which provides superior picture quality. The progressive scan video quality is only available when using Y Pb Pr connection and a progressive scan TV is required.

- 1 Connect the component video cables (red/blue/green - not supplied) from the **Y Pb Pr** jacks on this unit to the corresponding component video input jacks (or labeled as Y Pb/Cb Pr/Cr or YUV) on your TV.
- 2 Connect the audio/video cable (red/white - supplied) from the **AUDIO OUT FRONT L/R** jacks on this unit to the audio input jacks (red/white) on your TV. Leave the yellow video cable disconnected.
- 3 Proceed to 'Getting Started - Setting up Progressive Scan feature' for detailed progressive feature setup.

Basic Connections (continued)

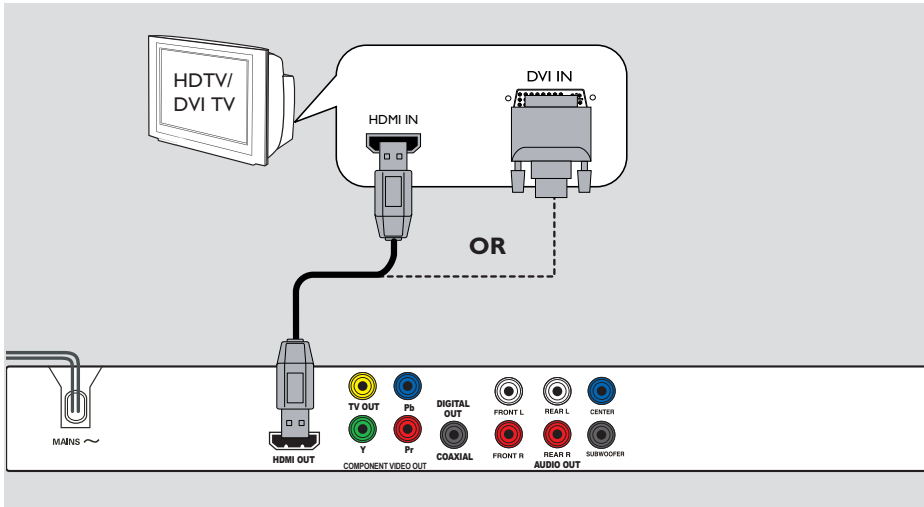

Option 3: Using HDMI or DVI TV jack

HDMI (High Definition Multimedia Interface) is a digital interface that allows pure digital audio/video transmission without the loss of image quality.

- Connect a HDMI cable (not supplied) from the **HDMI OUT** jack on this unit to the HDMI input jack on a HDMI-compatible device (e.g., HDMI TV, HDCP compliant DVI TV).

Notes:

- This unit is EasyLink compatible. It enables connected devices to control each other over HDMI, see 'Setup Menu Options - { Video Setup > HDMI Setup > EasyLink }' for details.
- For HDCP compliant or DVI TV, you need a HDMI-DVI adaptor cable (not supplied) to connect the DVI input jack from your TV to the HDMI OUT jack on this unit.

Helpful Hint:

- *The HDMI-DVI cable has only video output capability. An audio connection is required for audio output, see 'Optional Connections' for details.*

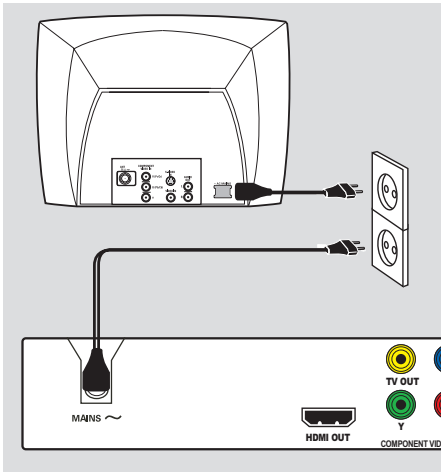

Step 2: Connecting the power cord

After everything is connected properly, plug the AC power cord into the power outlet.

Never make or change any connections with the power turned on.

Helpful Hint:

- Refer to the type plate at the rear or bottom of the product for identification and supply ratings.

Optional Connections

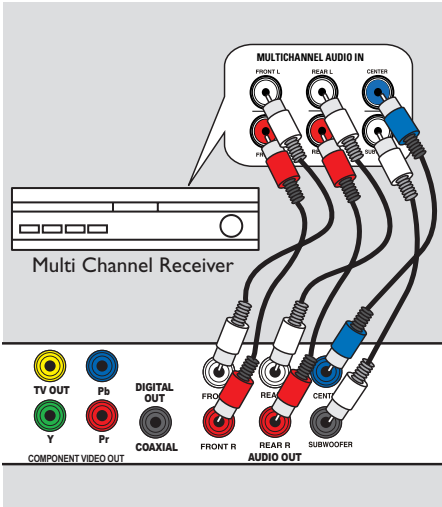

Connecting to a Multi Channel Receiver

You can connect this unit to a multi channel audio system in order to enjoy 5.1 channel sound.

- 1 Connect the audio cables (not supplied) from the **AUDIO OUT (FRONT L/R, REAR L/R, CENTER and SUBWOOFER)** jacks on this unit to the corresponding audio input jacks on your connecting device.
- 2 For video connection, see 'Basic Connections - Step 1: Connecting to television' for details.

Helpful Hint:

– You have to set the appropriate Analog Output setting. Otherwise, no sound or interference may occur. See 'Setup Menu Options - Audio Setup Page > Analog Output' for details.

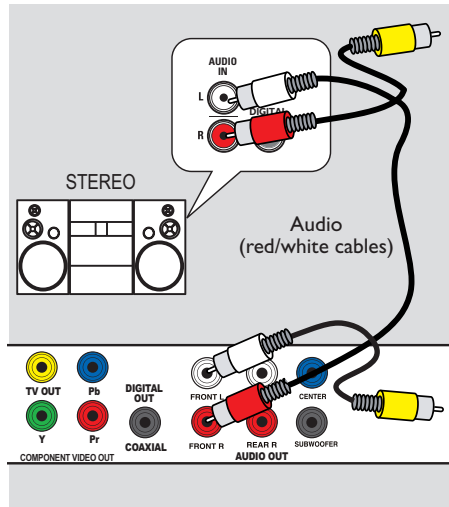

Connecting to an Analog Stereo System

You can connect this unit to a two channel stereo system (e.g. mini system, analog receiver) in order to enjoy stereo sound output.

- 1 Connect the audio/video cables (red/white - supplied) from the **AUDIO OUT FRONT L/R** jacks on this unit to the audio input jacks (red/white) on your connecting device. Leave the yellow video cable disconnected.
- 2 For video connection, see 'Basic Connections - Step 1: Connecting to television' for details.

Helpful Hint:

– See 'Setup Menu Options - Audio Setup Page' for optimum audio settings.

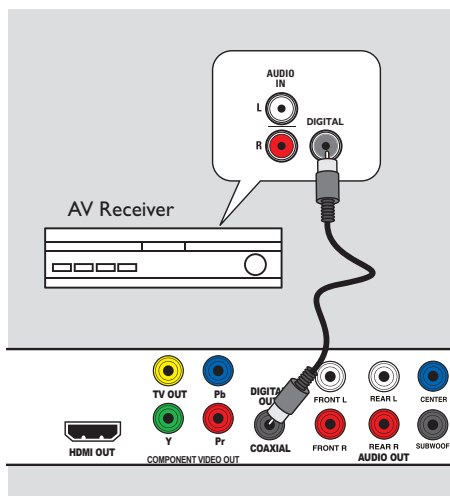

Connecting to a Digital AV Amplifier/Receiver

You can connect this unit to an AV amplifier/receiver in order to enjoy quality sound.

- 1 Connect a coaxial cable (not supplied) from the **COAXIAL DIGITAL OUT** jack on this unit to the digital coaxial input jack of the connected device.
- 2 For video connection, see 'Basic Connections - Step I: Connecting to television' for details.

Helpful Hint:

– You have to set the appropriate *Digital Audio Output* setting. Otherwise, no sound or interference may occur. See 'Setup Menu Options - Audio Setup Page - Digital Audio setup' for details.

Getting Started

Finding the correct viewing channel

- 1 Press **STANDBY-ON** to turn on this unit.
- 2 Turn on the TV and switch it to the correct video-in channel. You should see the **blue DVD background screen**.
 - You may go to the lowest channel on your TV, then press the Channel Down button on your TV's remote control until you see the Video In channel.
 - You may press **↵** button repeatedly on your TV's remote control.
 - Usually this channel is between the lowest and highest channels and may be called FRONT, A/V IN, VIDEO, etc..
 - Refer to your TV's user manual on how to select the correct input on your TV.
- 3 If you are using external device, (such as audio system or receiver), turn it on and select the appropriate input source for this unit output. Refer to the device user manual for detail.

Setting language preferences

The language options are different depending on your country or region. It may not correspond to the illustrations shown on the user manual.

On-screen display (OSD) language

Select this to change the language of the On screen display menu of this unit. The menu language will remain once you have set it.

- 1 Press **SETUP** on the remote control.
- 2 Use **▲▼** keys to select { **OSD Language** } in the menu and press **▶**.

General Setup Page	
Disc Lock	
OSD Language	Auto (CHI)
Sleep	ENGLISH
Lip Sync	中文 (简体)
Volume	
Auto Standby	
DivX(R) VOD Code	

- 3 Use **▲▼** keys to select a language and press **OK** to confirm.

Notes:

- To synchronize with a Philips 'EasyLink' TV, the OSD language must be set to { Auto (xxx) }. This is the language available from the Philips 'EasyLink' TV.
- If a non-supported language is selected, the default OSD language of this unit will be used.

Audio, Subtitle and Menu language for DVD playback

You can select your preferred language settings for DVD playback. If the selected language is not available on the disc, the disc's default language is used instead.

- 1 Press **■** twice to stop playback (if any), then press **SETUP**.
- 2 Press **▶** repeatedly to select **{ Preference Page }**.
- 3 Use **▲▼** keys to select one of the options below and press **▶**.

Preference Page	
Audio	English
Subtitle	Chinese
Disc Menu	French
Parental	Spanish
PBC	Portuguese
Mp3 / Jpeg Nav	Polish
Password	Italian ▼

{ Audio }

Select this to change disc sound track language.

{ Subtitle }

Select this to change the subtitle language.

{ Disc Menu }

Select this to change the language of the disc menu.

- 4 Use **▲▼** keys to select a language and press **OK** to confirm.

If the language you want is not in the list, then select { Others }, then use the **numeric keypad 0-9** on the remote to enter the 4-digit language code 'XXXX' (see 'Language Code') and press **OK**.

- 5 Repeat steps 3 - 4 for other language settings.

Getting Started (continued)

Setting up Progressive Scan feature

(for Progressive Scan TV only)

The progressive scan displays twice the number of frames per second than interlaced scanning (ordinary normal TV system). With nearly double the number of lines, progressive scan offers higher picture resolution and quality.

Before you start...

Ensure that you have connected this unit to a progressive scan TV (see 'Option 2: Connecting to a Progressive Scan TV or component video input').

- 1 Turn on the TV to the correct viewing channel for this unit.
→ Make sure that the TV's progressive scan mode is turned off (or set to interlaced mode). Refer to your TV's user manual.
- 2 Turn on this unit and press **SETUP** on the remote control.
- 3 Press **▶** repeatedly to select **{ Video Setup Page }**.
- 4 Use **▲▼** keys to select **{ Progressive }** > **{ On }** in the menu and press **OK** to confirm.

Video Setup Page	
TV Type	
TV Display	
Progressive	On
Picture Setting	Off
HD JPEG	
HDMI Setup	

- 5 Read the notification message on the TV and confirm your action by selecting the **{ OK }** in the menu and press **OK**.

There will be no picture on your TV at this state until you have turned on the progressive scan mode on your TV.

- 6 Turn on your TV progressive scan mode, refer to your TV's user manual.
→ A message appears on the TV.
- 7 Confirm your action by selecting the **{ OK }** in the menu and press **OK**.
→ The setup is now completed and you can start to enjoy the high quality picture.

If no picture is displayed

- 1 Press **▲** to open the disc tray.
- 2 Press **numeric keypad '1'** on the remote control.
→ The unit background screen appears.

Helpful Hints:

- If a blank/distorted screen appears, wait for 15 seconds for the auto recovery.
- Some progressive scan TVs are not fully compatible with this unit, resulting in an unnatural picture when playing back a DVD VIDEO disc in the progressive scan mode. In such a case, turn off the progressive scan feature on this unit and your TV.

Setting the EasyLink control

This feature enables HDMI CEC compliant devices to control each other with a single remote control. It is only available if you have connected this unit to HDMI CEC compliant TV or device with HDMI cable.

- 1 Turn on the HDMI CEC operations on your TV and other connected devices. (Refer to your TV or connected devices manual for details.)
- 2 Press **SETUP** on the remote control.
- 3 Press **▶** repeatedly to select { **Video Setup Page** }.
- 4 Use **▲▼** keys to select { **HDMI Setup** } > { **EasyLink** } and press **▶** to access.

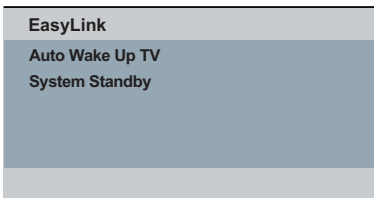

- The functions are turned on by default in the factory.
 - To disable { **Auto Wake Up TV** } feature, select { **Off** }.
 - To disable { **System Standby** } feature, select { **Decline** }.
- 5 To exit, press **SETUP**.

One touch control

Notes:

- To enable one touch play function, a video disc must be placed in the disc compartment before operation.
- Philips does not guarantee 100% interoperability with all HDMI CEC compliant devices.

One touch play

- Press **⏪**.
 - It turns on this unit and start disc play.
 - Your TV automatically turns on and switches to the correct video channel.

One touch input switching

While this unit and TV are turned on;

- Select a TV channel to watch TV programme or start play on other connected device.
 - This unit automatically switches to the corresponding audio input and output the sound from its speakers system.

One touch power off

- Press **STANDBY/POWER** button to turn off this unit and all the HDMI CEC compliant devices.
 - When using this unit's remote control, you have to press and hold **⏪**.

Disc Operations

Playable discs















This unit plays:

- Digital Versatile Discs (DVDs)
- Video CDs (VCDs)
- Super Video CDs (SVCDs)
- Finalized DVD Recordable (DVD±R), DVD Rewritable (DVD±RW)
- Audio Compact Discs (CDs)
- MP3/ WMA discs
 - The file extension has to be '.mp3', '.wma'
 - JPEG/ISO format
 - Maximum 14 characters display.
 - Supported bit-rate;
 - 32 – 320 kbps (MP3)
 - 64 – 192 kbps (WMA)
- Picture files (Kodak, JPEG) on CD-R(W)/DVD+R(W)
 - The file extension has to be '.JPG' and not '.JPEG.'
 - JPEG/ISO format
 - It can only display DCF-standard still pictures or JPEG pictures such as TIFF.
- DivX® files on CD-R(W)/DVD+R(W):
 - The file extensions has to be '.AVI', '.MPG' or '.MP4'.
 - DivX® Certified, DivX® Ultra Certified
 - Q-pel accurate motion compensation
 - Global Motion Compensation (GMC) playback

Region codes for DVD discs

DVD discs and players are designed with regional restrictions. Before playing a disc, make sure the disc is for the same region as this unit. The region code for this unit is indicated at the rear panel.

Region	Discs that can be played
U.S.A. and Canada regions	 
U.K and Europe regions	 
Asia Pacific, Taiwan, Korea	 
Australia, New Zealand, Latin America	 
Russia and India regions	 
China, Calcos Islands, Walls and Futuna Islands	 

Helpful Hints:





- This unit supports up to a maximum of 10 sessions for CD and 10 multi border for DVD.

Disc Operations (continued)

Notes:

- If the inhibit icon  appears on TV when a button is pressed, it means the function is not available on the current disc or at the current time.
- **Never put any objects other than discs in the disc tray. Doing so may cause this unit to malfunction.**

Playing a disc



- 1 Press  to turn on this unit.
- 2 Turn on the TV to the correct viewing channel for this unit.
- 3 Press  to open the disc tray.
- 4 Load a disc into the disc tray and press .
 - Make sure the disc label is facing towards you.
- 5 Playback starts automatically.
 - If not, press .
 - See the following pages for more playback options and features.

Helpful Hints:



- *Never close the disc tray manually.*
- *If you are having trouble playing a certain disc, remove the disc and try a different one. Improperly formatted discs cannot be played on this unit.*
- *Some discs cannot be played on this unit due to the configuration and characteristics of the disc, or due to the condition of recording and authoring software that was used.*

Basic playback controls





Pausing playback

- During playback, press .
 - To resume playback, press .





Selecting another track/chapter/ title

- Press  /  or use the **numeric keypad 0-9** to enter a track/chapter/title number.
 - If the repeat track mode is active, press  again to replay the same track/chapter/title.

Searching backward/forward (not applicable for JPEG)

- Press and hold  / .
 - While searching, press  /  repeatedly to select different search speed (2X, 4X, 8X, 16X, 32X).
 - To resume normal playback, press .

Playing in slow motion mode (not applicable for JPEG/WMA/MP3/CD)

- During playback, press   to start slow motion play.
 - Sound will be muted. Press   repeatedly to select different play speed (1/2, 1/4, 1/8, 1/16).
 - Note:** Slow backward motion playback is only possible for DVD.
 - To resume normal playback, press .

Stopping playback

- Press .

Disc Operations (continued)

Helpful Hints:

- For video disc, playback always resumes from the point where it was last stopped. To start playback from the beginning, press **⏮** while the message 'Play from the start, press [PREV]' is displayed.
- Screen saver starts automatically if playback is stopped or paused for about 5 minutes.

Other playback features for video discs

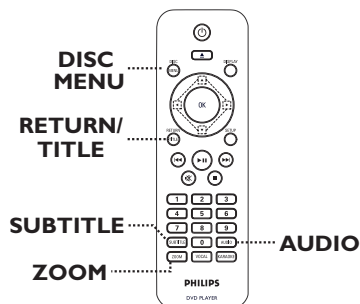

Note:

The operating features described here might not be possible for certain discs. Always refer to the instructions supplied with the discs.

Using the Disc Menu

Depending on the disc, a menu may appear on the TV once you load in the disc.

To select a playback feature

- Use **▲▼◀▶** keys or **numeric keypad 0-9** on the remote control, then press **OK** to start playback.

To access or remove the menu

- Press **DISC MENU** on the remote control.

Zooming

This option allows you to zoom and pan through the picture on the TV.

- 1 During playback, press **ZOOM** repeatedly to select a different zoom factor.
→ Playback continues.
- 2 Use **▲▼◀▶** keys to pan through the enlarged picture.
- 3 Press **ZOOM** repeatedly to return to the original size.

Changing sound track language

This operation works only on DVDs with multiple sound track languages, or VCD/SVCDs with multiple audio channels.

For DVD

- Press **AUDIO** repeatedly to select the available audio languages.

For VCD/SVCDs

- Press **AUDIO** repeatedly to select the available audio channels provided by the disc.

Changing subtitle language

This operation works only on DVDs with multiple subtitle languages. You can change to your desired language during playback.

- Press **SUBTITLE** repeatedly to select different subtitle languages.

Playback Control (VCD/SVCD)

Playback Control (PBC) playback allows you to play VCDs/SVCDs interactively, following the menu on the display.

For VCDs with PBC feature (version 2.0 only) and SVCDs

- Press **DISC MENU** to turn on or off the PBC mode.
→ If the PBC mode is turned on, the PBC menu (if available) appears on the TV.
→ If the PBC mode is turned off, it skips the PBC menu and playback from the first track.
- If the PBC mode is turned on, pressing **RETURN/TITLE** during playback will return to the PBC menu.

Helpful Hint:

– You cannot use numeric keypad 0-9 to select track if PBC mode is on.

Disc Operations (continued)

Using Display menu options

This unit can display the disc playback information (for example, title or chapter number, elapsed playing time), a number of operations can be done without interrupting disc playback.

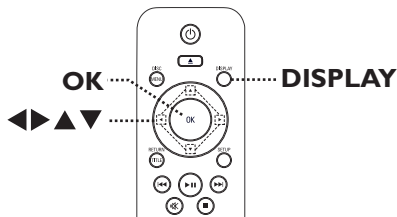

- 1 During playback, press **DISPLAY** on the remote control.
→ The available disc information appears on the TV.

(DVD)

MENU		▶
Title	01/01	
Chapter	01/01	
Audio	5.1CH	Others
Subtitle	Off	▼
Bitrate 61 [] Title Elapsed 0:48:59		

(VCD/SVCD)

MENU		▶
Track	01/21	
Disc Time	1:12:32	
Track Time	0:02:29	
Repeat	ab	▼
Bitrate 61 [] Total Elapsed 0:48:59		

- 2 Use **▲▼** keys to view the information and press **OK** to access.
- 3 Use the **numeric keypad 0-9** to input the number/time or use **▲▼** keys to make the selection.
- 4 Press **OK** to confirm.
→ Playback changes to the selected operation.

Selecting title/chapter/track

This option allows you to skip to a specific title/chapter/track in the current disc.

- 1 Move to { Title } / { Chapter } or { Track } option in the display menu and press **▶**.

Note: { Track } option can only be selected if PBC is set to off. To turn off PBC mode, press **DISC MENU**. See 'Disc Operations - Playback Control (VCD/SVCD)' for details.

- 2 Use the **numeric keypad 0-9** to input the valid number.
→ Playback skips to the selected operation.

Searching by time

This option allows you to skip to a specific point in the current disc.

- 1 Move to { TT Time / CH Time / Disc Time / Track Time } in the display menu and press **▶**.
- 2 Use the **numeric keypad 0-9** to enter the time where playback should start (eg. 0:34:27).
→ Playback skips to the selected time.

Viewing playing time

It shows the remaining/elapsed time display of the current disc.

- 1 Move to { Time Disp } in the display menu and press **▶**.
→ The information and display are different depending on the disc type.

For DVD

Display	Descriptions
Title/Chapter Elapsed	Title or Chapter elapsed playing time.
Title/Chapter Remain	Title or Chapter remaining playing time.

For VCD/SVCD

Display	Descriptions
Total/Single Elapsed	Disc or Track elapsed playing time.
Total/Single Remain	Disc or Track remaining playing time.

Switching camera angles

This option is only available on DVDs that contain sequences recorded from different camera angles. This allows you to view the picture from different angles.

- 1 Move to { Angle } in the display menu and press **▶**.
- 2 Use the **numeric keypad 0-9** to input a valid number.
→ Playback changes to the selected angle.

Preview function (VCD/SVCD/DVD)

This function allows you to preview the contents of a VCD/SVCD/DVD disc.

- 1 Move to { Preview } in the display menu and press **▶**.
→ The preview menu appears.

(DVD)

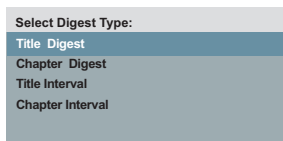

(VCD/SVCD)

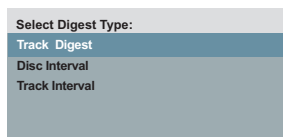

- 2 Use **▲▼** keys to select one of the preview type and press **OK**.
→ Thumbnail pictures of each segment appear on the TV.

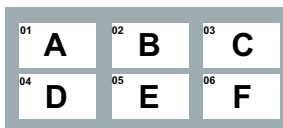

- To go to the previous or next page, press **◀◀ / ▶▶**.
- 3 Use **▲▼◀▶** keys to select a thumbnail picture and press **OK** to start playback from there.

Disc Operations (continued)

Selecting various repeat functions

This function allows you to select the different repeat play options.

For DVD/VCD/SVCD

- 1 Move to { Repeat } in the display menu and press ►.

DVD

- Chapter (repeat current chapter)
- Title (repeat current title)
- All (repeat entire disc)
- Off (exit repeat mode)

VCD/SVCD

- Track (repeat current track)
- All (repeat entire disc)
- Off (exit repeat mode)

For Audio CD

- 1 Press **DISPLAY** repeatedly to select { Off }, then press ◀/▶ to select the following repeat mode.
 - Track (repeat current track)
 - All (repeat entire disc)
 - Off (exit repeat mode)

For MP3/WMA/JPEG/DivX®

- 1 In stop mode, press **DISPLAY** repeatedly to select the following repeat mode.
 - Single (repeat current file once)
 - Repeat One (repeat current file)
 - Repeat Folder (repeat all files in the current folder)
 - Folder (repeat all files in a folder)

Helpful Hints:

- Repeat playback is not possible on VCDs or SVCDs when the PBC mode is turned on.

Repeating a specific section (A-B)

- 1 Move to { Repeat ab } in the display menu.
- 2 Press **OK** at the start point.
- 2 Press **OK** again to end the section.
 - The section will now repeat continuously.
- 3 Press **OK** again to resume normal playback.

Helpful Hints:

- The marked section for repeat playback is only possible within the same track/chapter.

Special Audio CD feature

This is a time search option for audio CD playback. Playback skips to the time you input, within the disc or track.

- 1 During playback, press **DISPLAY** repeatedly to toggle between different time input options.

Display	Descriptions
Disc Go To	Time search within the disc.
Track Go To	Time search within a track.
Select Track	Select a track number.

- 2 Use the **numeric keypad 0-9** to enter the time where playback should start (minutes:seconds).
→ Playback skips to the selected time.

Disc Operations (continued)

Playing a DivX® disc

This unit supports the playback of DivX movie which you can copy from your computer onto a recordable disc. See 'Setup Menu Options - { General Setup Page > DivX(R) VOD Code }' for details.

- 1 Load a DivX disc.
- 2 Use ▲▼ keys to select to the file you want to play.
- 3 Press **OK** to start playback.

During playback;

- If the DivX disc has multilingual subtitles, you can press **SUBTITLE** on the remote control to change the subtitle language.
- If the DivX disc has different audio tracks, you can press **AUDIO** on the remote control to change the audio stream.

Helpful Hints:

- Subtitle files with the following file name extensions (.srt, .smi, .sub, .ssa, .txt) are supported but do not appear on the file navigation menu.
- The subtitle file name (.sub) has to be saved under the same file name as the movie (.avi) in the same folder.

Advance features of the DivX Ultra

Features	Descriptions
XSUB™ subtitles	– allow multiple language subtitles selection for movie.
Interactive video menus	– provide easy access and control. – quick navigation to various scenes/features and select audio/subtitle options.
Alternate audio tracks	– enable audio tracks in multiple language versions. – separate audio tracks for specific speaker configurations.
Chapter points	– provide flexibility, – allow jump straight to the scene you want to watch from any point in video.

Playing a JPEG photo disc (slide show)

Before you start ...

Turn on your TV to the correct Video In channel. See 'Finding the correct viewing channel' for details.

- 1 Load a photo CD (Kodak Picture CD, JPEG).
 - The picture menu appears on the TV.
 - For Kodak disc, the slide show begins automatically.
- 2 Press **▶▶** to start slide-show playback.

During Playback,

- Press **▶▶** to pause or resume playback.
- Press **◀◀ / ▶▶** to play another file in the folder.

Helpful Hint:

– It may require longer time to display the disc content due to the large number of songs/pictures compiled into the disc.

Supported file format:

- The file extension has to be '*.JPG' and not '*.JPEG'.
- This unit can only display digital camera pictures according to the JPEG-EXIF format, typically used by almost all digital cameras. It cannot display Motion JPEG, or pictures in formats other than JPEG, or sound clips associated with pictures.

Preview function

- 1 During playback, press **DISPLAY**.
 - 12 thumbnail pictures will be displayed on the TV.



- 2 Press **◀◀ / ▶▶** to display pictures on the previous/next page.
- 3 Use **▲▼◀▶** keys to select one of the pictures and press **OK** to start playback.
- 4 Press **DISC MENU** to return to Picture CD menu.

Zooming

- 1 During playback, press **ZOOM** repeatedly to select a magnification level.
- 2 Use **▲▼◀▶** keys to pan through the enlarged image.

Flip/Rotate picture

- During playback, use **▲▼◀▶** keys to rotate/flip the picture on the TV.

Action	Remote control
flip the picture vertically.	▲
flip the picture horizontally.	▼
rotate the picture counter-clockwise.	◀
rotate the picture clockwise.	▶

Disc Operations (continued)

Playing a MP3/WMA disc

This unit can playback most of the MP3 and WMA files recorded on a recordable disc or commercial CD.

Before you start ...

Turn on your TV to the correct Video In channel. See 'Finding the correct viewing channel' for details.

- 1 Load a MP3/WMA disc.
 - The disc reading time may exceed 30 seconds due to the complexity of the directory/file configuration.
 - The disc menu appears on the TV.

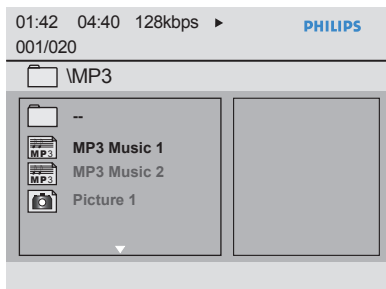

- 2 Use ▲▼ keys to select a desired folder and press **OK** to open the folder.
- 3 Use ▲▼ keys to select a file and press **OK** to start playback.
 - Playback starts from the selected file and continues through the end of the folder.

During playback:

- Use ◀◀ / ▶▶ keys to playback another file in the current folder.
- Press ◀ / ▶ repeatedly for fast forward/backward search on the music file.
- To select another folder from current disc, use ▲▼ keys to navigate back to the root menu.
- 4 To stop playback, press ■.

Helpful Hints:

- You can set to display or skip the folders when you load a MP3/JPEG disc. Press **SETUP**, then go to { Preference Page > Mp3/Jpeg Nav }.
- Only the first session of a multi-session CD will be played back.
- It is normal to experience an occasional 'skip' while listening to your MP3/WMA disc due to poor clarity of digital contents during internet downloading.
- If any special characters are present in the MP3/WMA track name (ID3) or album name, it might not be displayed correctly on the screen because this unit does not support the characters.
- The ID3/Meta information will not display when the playback file is not selected.

Playing music and photo files simultaneously

You can create a musical slide show playback if the disc contains both the MP3/WMA music and JPEG picture files.

- 1 Load a disc that contains both MP3/WMA and JPEG files.
- 2 Use ▲▼ keys to select a MP3/WMA file from the disc menu and press **OK** to start playback.
- 3 During MP3/WMA playback, use ◀▶▲▼ keys to select a JPEG file from the disc menu and press **OK**.
→ Slideshow begins and continues till the end of the photo folder or album.
- 4 To stop simultaneous playback, press ■ twice.

Helpful Hints:

- Some files on Kodak or JPEG disc may be distorted during playback due to the configuration and characteristics of the disc.
- During simultaneous playback, fast forward / backward or slow forward / backward is not available.

Karaoke Operation

Playing a Karaoke disc

Before you start...

Turn on your TV to the correct Video In channel. Press AV, VIDEO, SELECT or  button on your TV's remote control until you see the blue DVD background.

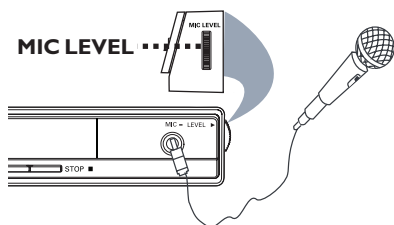

- 1 Connect a microphone (not supplied) to the **MIC** jack on the front panel of this unit.
- 2 Load a karaoke disc.
 - If the disc menu appears, use **▲▼◀▶** keys to make your selection and press **OK** to start playback.
- 3 Press **KARAOKE** on the remote control repeatedly to select { MIC ON/OFF }.
 - Use **◀▶** keys to turn the microphone { ON } or { OFF }.
- 4 Adjust the microphone volume up or down by using **MIC LEVEL** on the side panel of the unit.
- 5 Press **VOCAL** repeatedly to toggle between various audio modes.
 - You can turn off the vocal or change the audio mode of the karaoke disc.
 - Start enjoying the karaoke.

Helpful Hint:

- Before connecting the microphone, set the microphone volume to the minimum level to prevent howling.

Using the Karaoke Menu option

- 1 Press **KARAOKE** on the remote control repeatedly to access the karaoke menu.

{ MIC }

- Use **◀▶** keys to turn the microphone { ON } or { OFF }.

{ Vol }

- Use **◀▶** keys to adjust the vocal level between 0 ~ 20. Select { 0 } for the lowest tone and { 20 } for the highest tone.

{ Echo }

- Use **◀▶** keys to adjust the echo level between 0 ~ 20.

{ Key }

- Use **◀▶** keys to adjust the pitch level between -16 ~ +16 that match your voice.

{ Karaoke Scoring }

- Use **◀▶** keys to select scoring ranks: { Off }, { Basic }, { Intermediate } or { Advance }.

Note: If you score 30 points and above at the end of the song, a karaoke score will appear on the TV. Press **OK** to exit the scoring and resume karaoke session.

Helpful Hint:

- Karaoke score function is only available for DVD and VCD discs.

Accessing the setup menu

You can change the settings in this unit to suit your particular requirements.

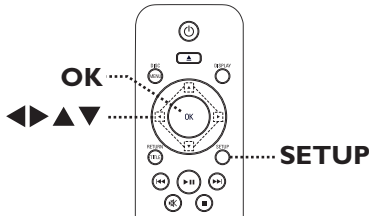

- 1 Press **SETUP** on the remote control.
→ The setup menu appears.
- 2 Use ◀▶ keys to select one of the setup menu.
 - If you are not able to access the { Preference Page }, press **SETUP** to exit the menu. Then, press ■ twice before you press the **SETUP** again.
- 3 Use ▲▼ keys to select a setup option and press ▶ to access.
- 4 Select your desired setting and press **OK** to confirm.
 - Instructions and explanations of the options are provided in the following pages.
 - If the option in the menu is grayed out, that means the setting is not available or cannot be changed in the current state.
- 5 To exit, press **SETUP**.

General Setup Page
Disc Lock
OSD Language
Sleep
Lip Sync
Volume
Auto Standby
DivX(R) VOD Code

See 'General Setup Page' on this chapter.

Audio Setup Page
Analog Output
Digital Audio Setup
HDMI Audio
Sound Mode
Speaker Setup
CD Upsampling
Night Mode

See 'Audio Setup Page' on this chapter.

Video Setup Page
TV Type
TV Display
Progressive
Picture Setting
HD JPEG
HDMI Setup

See 'Video Setup Page' on this chapter.

Preference Page
Audio
Subtitle
Disc Menu
Parental
PBC
Mp3 / Jpeg Nav
Password ▼

See 'Preference Page' on this chapter.

Setup Menu Options (continued)

General Setup Page (underlined options are the factory default settings)

Disc Lock

Not all discs are rated or coded by the disc maker. You can prevent play of specific discs with the disc lock function. Up to 20 discs can be locked.

- { **Lock** }
 - To block the playback of the current disc. Subsequent access to a locked disc requires a six-digit password. The default password is '136900' (see { Preference Page - Password }).
- { **Unlock** }
 - All discs can be played.

OSD Language

Select the menu language for this unit's on-screen display.

Sleep

The sleep timer enables this unit to switch to standby mode automatically after the selected a preset time.

- { **15/30/45/60 Mins** }
 - Select the preset minutes for switching this unit to standby mode automatically.
- { **Off** }
 - Turn off the sleep mode.

Lip Sync

This feature allows you to adjust the audio delay times if the video playback is slower than the audio output streams, hence resulting in lip-sync.

Access the lip sync setup menu. Use ◀▶ keys to set the delay times (00 ~ 200 ms) for the audio output and press **OK** to exit.

Setup Menu Options (continued)

General Setup Page (underlined options are the factory default settings)

Volume

This setting allows you to adjust the volume level.

Access the volume setup menu. Use ◀▶ keys to set the volume level between 00 ~ 20 and press **OK** to exit.

Auto Standby

Select this to switch this unit to standby mode when it is not in use for a period of time.

- { On } – Switched to low power standby mode when playback has paused or stopped for more than 15 minutes.
- { **Off** } – Switch off the auto standby mode.

DivX(R) VOD Code

Philips provides you with the DivX® VOD (Video On Demand) registration code that allows you to rent or purchase videos from DivX® VOD service at <http://www.divx.com/vod>. All the downloaded videos from DivX® VOD can only be played back on this unit.

Press ▶ to see the registration code and press **OK** to exit.

Setup Menu Options (continued)

Audio Setup Page (underlined options are the factory default settings)

Analog Output

This setting is only required if you have connected the audio output of this unit to a stereo device, multi channel audio system or TV using the analog output jack.

- { **LT/RT** } – The connected device has a built-in Dolby Pro Logic decoder. It can deliver the surround sound through the two speakers.
- { **Stereo** } – The connected device can only output stereo audio through two speakers.
- { **V SURR** } – For virtual surround sound effects.
- { **Multi Channel** } – Enable multi-channel output.

Digital Audio Setup

This setting is only required if you have connected the audio output of this unit to an amplifier/receiver using the digital output jack.

- { **Digital Output** } – { **Off** }
Disable digital audio output. Select this if you are using the analog audio jacks to connect this unit to a TV or Stereo system.
- { **All** }
The connected device supports multi-channel audio formats. The digital audio format will be output as on disc.
- { **PCM Only** }
The connected device does not support multi-channel formats. All audio signals are downmixed to PCM format (2-channel).

Setup Menu Options (continued)

Audio Setup Page (underlined options are the factory default settings)

Digital Audio Setup Continued...

- { **LPCM Output** } – { **48 K** }
Select this to play disc recorded at sampling rate of 48 kHz.
- { **96 K** }
Enable 96 kHz output on digital audio if the amplifier/receiver is compatible with high sampling rate audio (88.2 / 96 kHz). However, if the sound output is distorted or there is no sound, change the setting to '48 K'.

Notes:

- Digital Audio Setup setting is only available if HDMI Audio is set to { **Off** }.
- LPCM Output can only be selected when { **PCM Only** } is activated. The higher the sampling rate, the better the sound quality.

HDMI Audio

This setting is only required if you are using the HDMI OUT jack to connect your TV or other display device.

- { **On** } – Enable audio output through HDMI connection.
- { **Off** } – Disable HDMI audio output. In this case, an alternative audio connection is required from this unit to your TV.

Sound Mode

Select the type of preset digital sound effect that can match the disc's content or optimize the sound of the musical style you are playing.

- { **3D** } – It provides a virtual surround sound experience through the left and right audio channels. Available options are: { **Off** }, { **Living Room** }, { **Hall** }, { **Arena** } and { **Church** }.
- { **Movie Mode** } – Movie sound effects. Available options are: { **Off** }, { **Sci-Fi** }, { **Action** }, { **Drama** } and { **Concert** } effect.
- { **Music Mode** } – Musical sound effects. Available options are: { **Off** }, { **Digital** }, { **Rock** }, { **Classic** } and { **Jazz** }.

Setup Menu Options (continued)

Audio Setup Page (underlined options are the factory default settings)

Speaker Setup

This function enables you to adjust the delay times (center and rear speakers only) and volume level for individual speakers. These adjustments let you optimises the sound according to your surroundings and setup.

{ **Front Speaker** } – { **Large** }

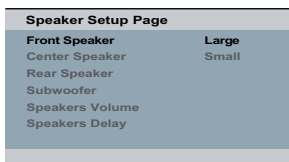

When connected speakers can produce low frequency signals below 120 Hz.

– { **Small** }

When connected speakers cannot produce low frequency signals below 120 Hz.

{ **Center Speaker/Rear Speaker** }

– { **Large** }

When connected speakers can produce low frequency signals below 120 Hz.

– { **Small** }

When connected speakers cannot produce low frequency signals below 120 Hz.

– { **Off** }

When no speaker is connected.

{ **Subwoofer** }

– { **On** }

When a subwoofer is connected.

– { **Off** }

When no subwoofer is connected.

{ **Speakers Volume** }

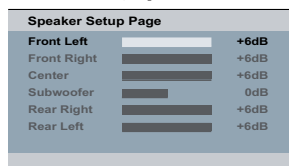

– Use ◀▶ keys to set the volume level for individual speakers (-6dB ~ +6dB).

{ **Speakers Delay** }

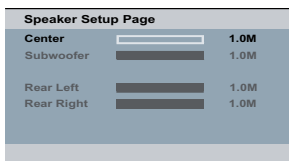

– Use ◀▶ keys to set the delay times (1m ~ 10 m) based on the listening position and distance to best suit your surround needs.

Note: Use the longer delay time settings when the rear speakers are closer to the listener than the front speakers.

Setup Menu Options (continued)

Audio Setup Page (underlined options are the factory default settings)

CD Upsampling

This feature enables you to convert the music CD to a higher sampling rate using sophisticated digital signal processing for better sound quality. If you have activated the CD upsampling, this unit automatically switches to stereo mode.

- { Off } – Disable CD-upsampling function.
- { **88.2 kHz (X2)** } – Convert the sampling rate of the CDs to twice as high as the original rate.
- { **176.4 kHz (X4)** } – Convert the sampling rate of the CDs to four times as high as the original rate.

Note: CD upsampling is only possible when playback the music CD in stereo mode.

Night Mode

This mode optimizes playback of sound at low volume. High volume outputs will be softened and low volume outputs will be enhanced to an audible level. This feature is only applicable for DVD video discs with Dolby Digital mode.

- { **On** } – Turn on night mode.
- { Off } – Turn off night mode. Select this to enjoy the surround sound with its full dynamic range.

Setup Menu Options (continued)

Video Setup Page (underlined options are the factory default settings)

TV Type

Select the color system that matches the connected TV. It enables playback of a different type of disc (PAL or NTSC disc) on this unit.

- { PAL } – For PAL-system TV.
- { Multi } – For TV that is compatible with both PAL and NTSC.
- { NTSC } – For NTSC-system TV.

TV Display

The picture shape can be adjusted to fit your TV.

- { 4:3 Pan Scan } – For a full-height picture with the sides trimmed.
- { 4:3 Letter Box } – For a 'wide-screen' display with black bars on the top and bottom.
- { 16:9 } – For wide-screen TV (frame ratio 16:9).

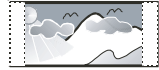

Progressive

Before enabling the progressive scan feature, you must ensure that your TV can accept progressive signals (a progressive scan TV is required) and that you have connected this unit to your TV using the Y Pb Pr. See 'Getting Started - Setting up Progressive Scan feature' for details.

- { On } – Turn on progressive scan mode. Read the instructions on the TV and confirm your action by pressing **OK** on the remote control.
- { Off } – Turn off progressive scan mode.

Note: The Progressive Scan setting will not be available when the HDMI video signal is detected.

Setup Menu Options (continued)

Video Setup Page (underlined options are the factory default settings)

Picture Setting

This unit provides three predefined sets of picture color settings and one personal setting which you can define yourself.

- { Standard } – Original color setting.
- { Vivid } – Vibrant color setting.
- { Cool } – Soft color setting.
- { Personal } – Select this to personalize the picture color setting. Use the ◀▶ keys to adjust to the setting that best suits your personal preference and press **OK** to confirm. For an average setting, select { 0 }.

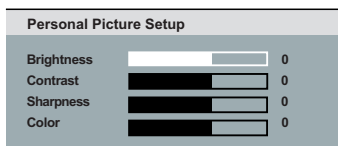

HD JPEG

HD JPEG allows you to enjoy untouched and uncompressed pictures at its original resolution. This feature is only applicable if you have connected this unit to a HDMI-compatible TV/device.

- { On } – Display high definition picture.
- { Off } – Display standard picture.

Note: This feature is only available for JPEG picture disc. This unit supports the display resolution of 720p and above.

Setup Menu Options (continued)

Video Setup Page (underlined options are the factory default settings)

HDMI Setup

It provides the picture settings to enhance the appearance and picture quality for disc playback. This feature is only applicable if you have connected this unit to a HDMI-compatible TV/device.

{ **Resolution** } – Select a suitable video resolution that is compatible with your TV display capability.

{ **Auto** }

It detects and selects the best supported video resolution automatically.

{ **480p, 576p, 720p, 1080i, 1080p** }

Manually select a video resolution. 'p' for progressive and 'i' for interlaced.

Note:

– If the selected resolution is not supported by your HDMI/DVI TV, a black screen will appear. In this case, wait for 5 seconds for auto recovery or use the composite (yellow) video cable to connect this unit and your TV. Turn on your TV to the correct input channel for the composite video and adjust the resolution setting to 480p/576p.

{ **Wide Screen Format** }

– Select a suitable screen display.

{ **4:3 Pillar Box** }

Display the 4:3 picture disc on the wide-screen TV without stretching. Black bars will be shown on the both sides of the TV.

{ **Super Wide** }

Display the 4:3 picture disc on the wide-screen TV with non-linear stretching (center position of the screen is stretched less than the side).

{ **Off** }

No aspect ratio adjustment is made when this option is selected.

Note: { Super Wide } and { 4:3 Pillar Box } is only applicable when this unit's resolution is set to 720p, 1080i or 1080p.

Setup Menu Options (continued)

Video Setup Page (underlined options are the factory default settings)

HDMI Setup

Continued...

- { **EasyLink** } – Enable HDMI CEC compliant TV/ devices to control each other with a single remote control.

Notes:

- Your TV and other connected devices must be compliant with HDMI CEC.
- You must turn on the HDMI CEC operations on your TV/ devices before you can enjoy the EasyLink controls. See your TVs/devices manual for details.
- Philips does not guarantee 100% interoperability with all HDMI CEC compliant devices.

{ **Auto Wake Up TV** }

Press STANDBY button to turn on (both your TV and this unit) and start video disc play (if a video disc is found in the disc tray). Your TV automatically switches to the correct video channel.

To disable this feature, select { **Off** }.

{ **System Standby** }

Press STANDBY/POWER button to turn off this unit and all the HDMI CEC compliant devices.

To disable this feature, select

{ **Decline** }.

Note: However, press and hold  button on this unit remote control can still turn off all the HDMI CEC compliant devices.

Note: If a notification message appears, confirm your setting by selecting { **OK** } in the menu and press **OK** to proceed.

Setup Menu Options (continued)

Preference Page (underlined options are the factory default settings)

Audio Select the preferred audio language for DVDs with multiple sound tracks.

Subtitle Select the preferred subtitle language for DVDs playback.

Disc Menu Select the preferred disc menu language for DVDs playback.

Note: If the selected audio/subtitle/disc menu language is not available on the DVDs, the disc's default language will be used instead.

Parental This setting allows you to control the playback of certain disc through a rating level. It works only on the DVDs with parental level assigned to the complete disc or to certain scenes on the disc.

- 1) Use **▲▼** keys to select a rating level from **1** to **8** and press **OK**.
- 2) Use the **numeric keypad 0-9** on the remote control to enter your six-digit password and press **OK**.

Notes:

- The ratings are country-dependent ('1' is considered material that is least offensive and '8' is most offensive). To disable parental controls and allow all discs to play, select '8'.
- Some DVDs are not encoded with a rating though the movie rating may be printed on the disc cover. The rating level feature does not prohibit playback of such discs. VCD, SVCD and CD have no level indication, so parental control has no effect on these type of discs.
- DVDs that are rated higher than the level you selected will not be played unless you enter the same six-digit password.

PBC Play Back Control feature is applicable for VCD/SVCD only. It allows you to play Video CDs (2.0) interactively, following the menu on the display.

- { **On** } – The index menu (if available) appears on the TV when you load a VCD/SVCD.
- { **Off** } – The VCD/SVCD skips the index menu and playback directly from the beginning.

Setup Menu Options (continued)

Preference Page (underlined options are the factory default settings)

Mp3/Jpeg Nav

Mp3/Jpeg Navigator can only be set if the disc is recorded with a menu. It allows you to select different display menus for easy navigation.

- { **Without Menu** } – Display all the files contained in the MP3/Picture disc.
- { **With Menu** } – Display the folder menu of the MP3/Picture disc.

Password

Select this to set the password for Parental control and Disc Lock. The default password is '136900'.

To change the password:

- 1) Press **OK** twice to access the change password menu.

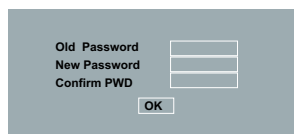

- 2) Use the **numeric keypad 0-9** on the remote control to enter your existing six-digit password at { Old Password }.

Note: When doing this for the first time or if you forget your existing password, enter '136900'.

- 3) Enter the new six-digit password at { New Password }.
- 4) Enter the new six-digit password again at { Confirm PWD }.
- 5) Press **OK** to confirm and exit.

DivX Subtitle

Select the font type that supports the recorded DivX subtitle.

- { **中文(简体)** } (Simplified Chinese)
 - Display a standard list of simplified Chinese subtitle fonts provided by this unit.

Default

This setting enables you to reset all the options and settings to the factory defaults, with exception of your password for Parental control and Disc Lock.

Press **OK** to confirm the default reset.

Software upgrade

Installing the latest software

Philips provides software upgrades to make sure that this unit is compatible with the newest formats. To check the updates, compare the current software version of this unit with the latest software version available at the Philips website.

- 1 Press **▲** to open the disc tray.
- 2 Press **numeric keypad '55'** on the remote control.
- 3 Write down the file name.
- 4 Press **SETUP**, then press **numeric keypad '1379'** to check the current software version.
- 5 Go to www.philips.com/support to check the latest software version available for this unit.
- 6 If the latest software version is higher than the software version of this unit, download it and store onto a CD-R.
- 7 Load the CD-R to this unit for upgrade operation.

Note:

Never unplug or turn off this unit during the upgrade.

- 8 Once complete, this unit will restart automatically.

WARNING

Under no circumstances should you try to repair this unit yourself, as this invalidate the warranty. Do not open this unit as there is a risk of electric shock.

If a fault occurs, first check the points listed below before taking this unit for repair. If you are unable to remedy a problem by following these hints, consult your dealer or Philips for help.

Problem	Solution
No power.	<ul style="list-style-type: none"> – Press STANDBY-ON on the unit to turn on the power. – Ensure that the AC outlet have power. – Disconnect the power cord from the power outlet. Reconnect and try again after a few minutes.
No picture.	<ul style="list-style-type: none"> – Refer to your TVs manual for correct Video In channel selection. Change the TV channel until you see the DVD screen. – If this happens when you turn on the progressive scan feature, wait for 15 seconds for the auto recovery or switch back to the default mode as below: <ol style="list-style-type: none"> 1) Press ▲ to open the disc tray. 2) Press numeric keypad '1' on the remote control. – If this happens after you set the color system, wait for 15 seconds for the auto recovery or switch back to the default TV color system: <ol style="list-style-type: none"> 1) Press ▲ on this unit. 2) Press numeric keypad '3' on the remote control.
Completely distorted picture or black/white picture.	<ul style="list-style-type: none"> – Check the video connection. – Ensure that the disc is compatible with this unit. – Sometimes a small amount of picture distortion may appear. This is not a malfunction. – The disc is dirty. Clean the disc.
No sound or distorted sound.	<ul style="list-style-type: none"> – Check the audio connections to the connected audio device. – Make sure that the connected audio device is turned on to the correct input source. – Set the digital output setting correctly, based on the device you connected to this unit. See 'Audio Setup Page – Digital Audio Setup' for details.

Troubleshooting (continued)

Problem	Solution
The remote control does not function properly.	<ul style="list-style-type: none">– Aim the remote control directly at the sensor on the front of this unit (not towards the TV).– Remove any obstacles between this unit and the remote control.– Batteries are weak, replace the batteries.– Check the polarities of the batteries are as indicated on the remote control (\pm signs).
The unit does not start playback.	<ul style="list-style-type: none">– Load a readable disc with the playback side facing inwards. The DVD+R/CD-R must be finalized.– Make sure the disc is not scratched or warped. Check if the disc is defective by trying another disc.– The disc is of a different region code.– You may need to enter the password in order to unlock the disc for playback.– Moisture may have condensed inside this unit. Remove the disc and leave this unit turned on for about an hour.
The buttons on the unit do not work.	<ul style="list-style-type: none">– There is a technical problem. Disconnect this unit from the power outlet for 10 seconds and reconnect again.
The aspect ratio of the screen cannot be changed even though you have set the TV display.	<ul style="list-style-type: none">– The aspect ratio is fixed on the DVD disc.– Depending on the TV, it may not be possible to change the aspect ratio.
Not able to select some items in the setup/system menu.	<ul style="list-style-type: none">– Press ■ button twice before selecting the disc setup menu.– Depending on the disc availability, some menu items cannot be selected.
Picture freezes momentarily during playback.	<ul style="list-style-type: none">– Check the disc for fingerprint/scratches and clean with a soft cloth wiping from center to edge.
Unable to select Progressive Scan on/off.	<ul style="list-style-type: none">– Check that the video output of this unit is connected using the Component Video (Y Pb Pr) jacks.– Remove the HDMI connection.

Troubleshooting (continued)

Problem	Solution
No audio output from HDMI connection.	<ul style="list-style-type: none">– You will not hear any sound from the HDMI output if the source device is only DVI/HDCP (High-bandwidth Digital Content Protection)-compatible.– It is not possible to output or copy-controlled DVD-Audio sources from the HDMI connection.– Make sure that the audio output setting is not turned off. See 'Setup Menu Options - { Audio Setup Page - HDMI Audio }' for details.
No video output from HDMI connection.	<ul style="list-style-type: none">– HDMI connection can only be made to HDMI-equipped devices with HDCP (High Bandwidth Digital Content Protection). If you wish to connect to a DVI connector (equipped with HDCP), you need a separate adaptor (DVI to HDMI).– Make sure the resolution of this unit matches the device you have connected using the HDMI. See 'Setup Menu Options - { Video Setup Page - HDMI Setup }' for details.– During resolution selection for DVI TV, a distorted or black screen may appear, see HDMI Setup.
No sound during DivX movies playback.	<ul style="list-style-type: none">– The audio codec may not be supported by this unit.
An DivX movie does not repeat.	<ul style="list-style-type: none">– Check that file size of the movie does not exceed the file size of the disc during downloading.
Certain DivX files do not play or are skipped.	<ul style="list-style-type: none">– Check that the DivX movie download is a complete file.– Make sure the file name extension is correct. You can check this using a computer with CD-ROM.– The unit is designed to playback DVD, VCD, SVCD, CD audio, MP3, WMA and DivX discs only. Other digital audio formats such as liquid audio, RM (RealMedia), WAV or non-audio files like '.doc', '.txt', '.pdf' are not supported.– Try to play the problem DivX files on a computer. If they do not work, the source file appears to be corrupted.– Try to download the file again from a different source, or if you have created the file yourself, save it with the correct settings.

Specifications

TV STANDARD

	(PAL/50Hz)	(NTSC/60Hz)
Number of lines	625	525
Playback	Multistandard (PAL/NTSC)	

VIDEO PERFORMANCE

Video DAC	12 bit, 108 MHz
Y Pb Pr	0.7 Vpp ~ 75 ohm
Video Output	1 Vpp ~ 75 ohm

VIDEO FORMAT

Digital	MPEG 2 for DVD, SVCD	
Compression	MPEG 1 for VCD	
	DivX®	

	50 Hz	60 Hz
Horiz. resolution	720 pixels	720 pixels
	1920 pixels	1920 pixels
Vertical resolution	576 lines	480 lines
	1080 lines	1080 lines

	50 Hz	60 Hz
Horiz. resolution	352 pixels	352 pixels
Vertical resolution	288 lines	240 lines

AUDIO FORMAT

Digital	MPEG/ AC-3/ PCM	compressed Digital 16, 20, 24 bits fs, 44.1, 48, 96 kHz
	MP3 (ISO 9660)	96, 112, 128, 256 kbps & variable bit rate fs, 32, 44.1, 48 kHz

Analog Sound Stereo
Dolby Surround compatible downmix from
Dolby Digital multi-channel sound

AUDIO PERFORMANCE

DA Converter	24 bit, 192 kHz	
DVD	fs 96 kHz	4 Hz - 44 kHz
	fs 48 kHz	4 Hz - 22 kHz
SVCD	fs 48 kHz	4 Hz - 22 kHz
	fs 44.1 kHz	4 Hz - 20 kHz
CD/VCD	fs 44.1 kHz	4 Hz - 20 kHz
Signal-Noise (1kHz)	> 90 dB	
Dynamic range(1kHz)	> 80 dB	
Crosstalk (1kHz)	> 70 dB	
Distortion/noise (1kHz)	> 65 dB	
MPEG MP3	MPEG Audio L3	

CONNECTIONS

Y Pb Pr Output	Cinch 3x
Video Output	Cinch (yellow)
Audio Output(Front L+R)	Cinch (red/white)
Digital Output	1 coaxial IEC60958 for CDDA / LPCM IEC61937 for MPEG 1/2, Dolby Digital
HDMI Output	

5.1 Channel Analog Output

Audio Front L+R	Cinch (white/red)
Audio Rear L+R	Cinch (white/red)
Audio Center	Cinch (blue)
Audio Subwoofer	Cinch (black)

CABINET

Dimensions (w x h x d)	360 x 37 x 209 mm
Weight	Approximately 1.4 kg

POWER CONSUMPTION

Power Supply Rating	110 V – 240 V; 50/60 Hz
Power consumption	< 10 W
Power consumption in Standby mode	< 1 W

Specification subject to change without prior notice.

Analog audio: Sound that has not been turned into numbers. Analog sound is available when you use the AUDIO LEFT/ RIGHT jacks. These red and white jacks send audio through two channels, the left and right.

Aspect ratio: Aspect ratio refers to the length to height ratio of TV. The ratio of a standard TV is 4:3, while the ratio of a high-definition or wide TV is 16:9. The letter box allows you to enjoy a picture with a wider perspective on a standard 4:3 screen.

AUDIO OUT jacks: Red and white jacks on the back of this unit that send audio to another system (TV, Stereo, etc.).

Bit Rate: The amount of data used to hold a given length of music; measured in kilobits per second, or kbps. Or, the speed at which you record. Generally, the higher the bit rate, or the higher the recording speed, the better the sound quality. However, higher bit rates use more space on a disc.

Chapter: Sections of a picture or a music piece on a DVD that are smaller than titles. A title is composed of several chapters. Each chapter is assigned a chapter number enabling you to locate the chapter you want.

Composite video (CVBS): A single video signal commonly used in most consumer video products.

Disc menu: A screen display prepared for allowing a selection of images, sounds, subtitles, multi-angles, etc., recorded on a DVD.

DivX: The DivX code is a patent-pending, MPEG-4 based video compression technology, developed by DivX Networks, Inc., that can shrink digital video to sizes small enough to be transported over the internet, while maintaining high visual quality.

Dolby Digital: A surround sound system developed by Dolby Laboratories containing up to six channels of digital audio (front left and right, surround left and right, center and subwoofer).

EasyLink: Philips EasyLink uses the HDMI CEC industry standard protocol to share functionalities between the unit and its connected devices. This feature is only available if you connect this unit to a HDMI CEC compliant TV with a HDMI cable.

HDMI: High-Definition Multimedia Interface (HDMI) is a high-speed digital interface that can transmit uncompressed high definition video and digital multichannel audio. It delivers perfect picture and sound quality, completely free from noise. HDMI is fully backward-compatible with DVI. As required by the HDMI standard, connecting to HDMI or DVI products without HDCP (High-bandwidth Digital Content Protection) result in no Video or Audio output.

HDCP (High-bandwidth Digital Content Protection) is a specification that provides a secure transmission of digital contents between different devices (to prevent unauthorized copying).

JPEG: A very common digital still picture format. A still-picture data compression system proposed by the Joint Photographic Expert Group, which features small decrease in image quality in spite of its high compression ratio. Files are recognized by their file extension 'JPG or JPEG'.

Glossary (continued)

MP3: A file format with a sound data compression system. 'MP3' is the abbreviation of Motion Picture Experts Group 1 (or MPEG-1) Audio Layer3. By using the MP3 format, one CD-R or CD-RW can contain about 10 times more data than a regular CD.

Multi-channel: DVD is specified to have each sound track constitute one sound field. Multi-channel refers to a structure of sound tracks having three or more channels.

Parental Control: A function of the DVD to limit playback of the disc by the age of the users according to the limitation level in each country. The limitation varies from disc to disc; when it is activated, playback will be prohibited if the software's level is higher than the user-set level.

PBC: Playback Control. A system of navigating a Video CD/Super VCD through on-screen menus recorded onto the disc. You can enjoy interactive playback and searching.

PCM (Pulse Code Modulation): A system for converting analog sound signal to digital signal for later processing, with no data compression used in conversion.

Progressive Scan: The progressive scan displays twice the number of frames per second than in an ordinary TV system. It offers higher picture resolution and quality.

Region code: A system allowing discs to be played only in the region designated. This unit will only play discs that have compatible region codes. You can find the region code of your unit by looking at the product label. Some discs are compatible with more than one region (or ALL regions).

Title: The longest section of a movie or music feature on DVD. Each title is assigned a title number, enabling you to locate the title you want.

TV OUT jack: Jack on the back of this unit that sends out video signals to the TV.

WMA: Windows Media™ Audio. Refers to an audio compression technology developed by Microsoft Corporation. WMA data can be encoded by using Windows Media Player version 9 or Windows Media Player for Windows XP. Files are recognized by their file extension '.WMA'.

