

MP3-CD Player / FM Tuner

EXP7361

User manual  
Manuel d'utilisation  
Manual del usuario  
Gebruikershandleidingen



**PHILIPS**

**MP3-CD Player / FM Tuner**

Meet Philips at the Internet  
<http://www.philips.com>



**CLASS 1  
LASER PRODUCT**



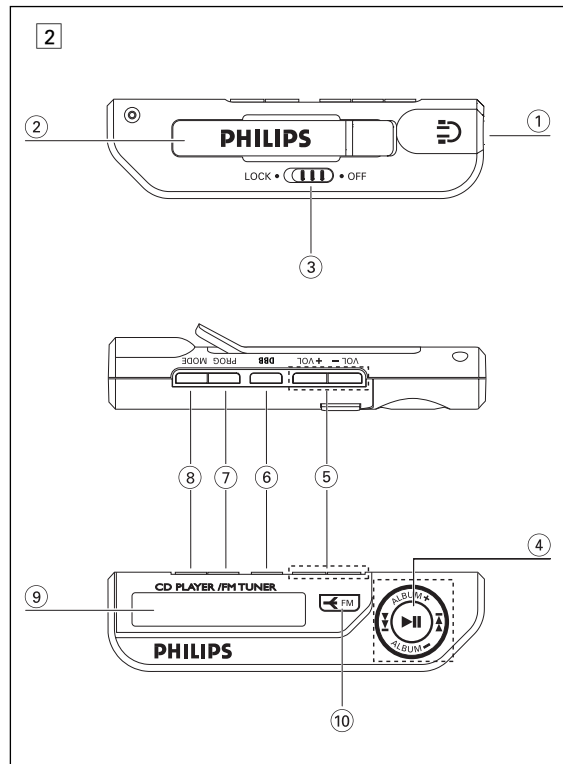
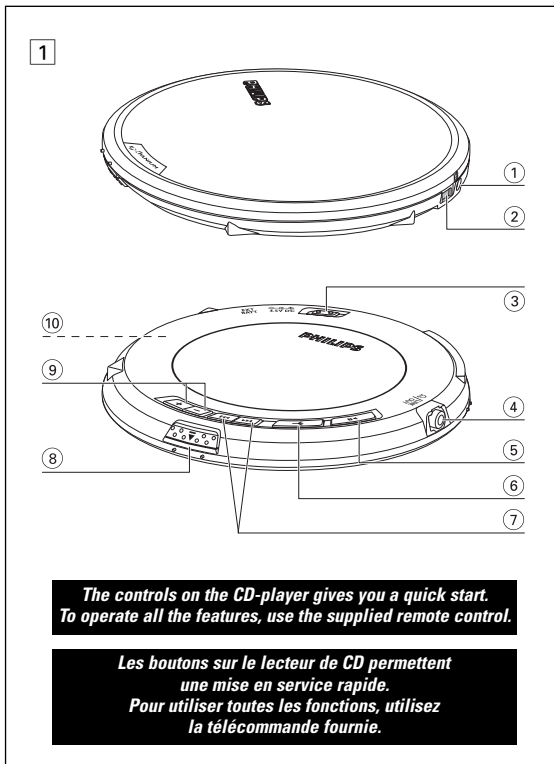

**QUICK START**

**MISE EN SERVICE RAPIDE**

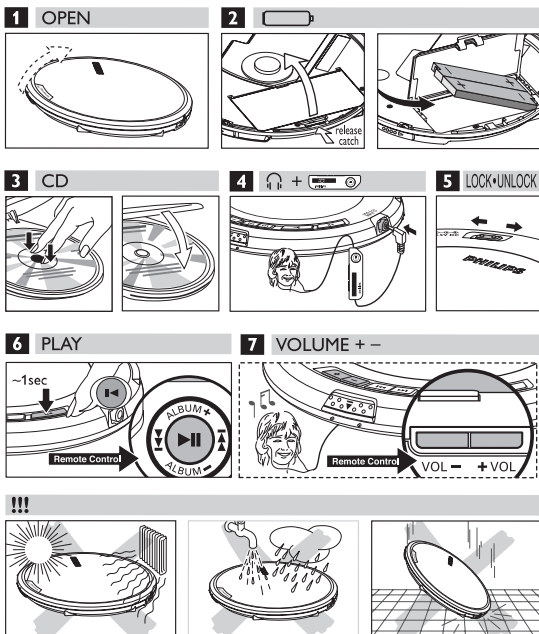

## English

## CONTROLS

### CONTROLS ( see figure 1 )

- ① 4.5V DC ..... jack for AC/DC adapter power supply
- ② EXT BATT ..... jack for external battery supply
- ③ LOCK • UNLOCK... locks/ unlocks all buttons on the set only
- ④ ↻ / LINE OUT ..... connect the remote control here and your headphones to the remote control.
- ⑤ ▶|| ..... switches the player on, starts or pauses CD play; stops CD play, clears a program or switches the player off. Press and hold ▶|| for 2 seconds to enter stop mode.
- ⑥ ⏪ ..... switches radio on/off.
- ⑦ ⏮ / ⏭ ..... skips and searches backward/ forward tracks; ..... (FM) tunes to stations
- ⑧ •• ▲ •• ..... opens the CD lid
- ⑨ VOLUME +/- ..... adjusts the volume.
- ⑩ rechargeable battery compartment ..... inside the CD player.

The model & serial numbers are located inside the battery compartment.

### Supplied Accessories:

- 1 x headphones HE570
- 2 x rechargeable batteries, AY3365
- 1 x external battery case, AY3380
- 1 x remote control, AY3786
- 1 x AC/ DC adapter, AY3170
- 1 x CD-ROM with free Musicmatch Jukebox software
- 1 x pouch, AY3268

## CD PLAYER AND CD HANDLING, Ⓜ

- Do not touch the lens (A) of the CD player.
- Do not expose the unit, batteries or CDs to humidity, rain, sand or excessive heat (caused by heating equipment or direct sunlight).
- You can clean the CD player with a soft, slightly dampened, lint-free cloth. Do not use any cleaning agents as they may have a corrosive effect.
- To clean the CD, wipe it in a straight line from the center toward the edge using a soft, lint-free cloth. A cleaning agent may damage the disc! Never write on a CD or attach a sticker to it.
- The lens may cloud over when the unit is moved suddenly from cold to warm surroundings. Playing a CD is not possible then. Leave the CD player in a warm environment until the moisture has evaporated.
- Active mobile phones in the vicinity of the CD player may cause malfunctions.
- Avoid dropping the unit as this may cause damage.

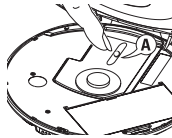

### Headphones HE570, LINE OUT

- Connect the remote control to ↻ / LINE OUT jack of the player and your headphones to the remote control.
- ↻ / LINE OUT can also be used for connecting the player to your HiFi system (with a signal lead) or to your car radio (with a cassette adapter/ FM stereo transmitter or signal lead). In both cases, the volume of the player must be set to volume level 22.



### IMPORTANT!

**Hearing safety:** listen at a moderate volume. using headphones at high volume can impair your hearing.

**Traffic safety:** do not use headphones while driving or cycling as you may cause an accident.

## REMOTE CONTROL AY3786

### CONTROLS ( see figure 2 )

- ① ↻ ..... 3.5 mm headphone jack.
- ② Clip
- ③ LOCK•OFF ..... locks/ unlocks all buttons on the remote control only.
- ④ ⏮ / ⏭ ..... skips and searches backward/ forward tracks; ..... (FM) tunes to stations
- ▶|| ..... switches the player on, starts or pauses CD play; stops CD play, clears a program or switches the player off. Press and hold ▶|| for 2 seconds to enter stop mode.
- ALBUM + / - ..... MP3/WMA-CD only :
  - selects the previous or next album
  - skips backward or forward
- ⑤ VOLUME +/- ..... adjusts the volume
- ⑥ DBB ..... switches the bass enhancement on and off
- ⑦ PROG ..... – programs tracks;  
– programs FM station presets.
- ⑧ MODE ..... selects playback options;  
to select and enter the display function, press and hold MODE for 3 seconds.
- ⑨ Display
- ⑩ FM ..... switches radio on/ off.

### Using the remote control

The remote control allows you to command all the functions on the player.

- 1 Firmly connect the remote control to ↻ / LINE OUT on the set.**
- 2 Firmly connect the headphones to the jack ↻ on the remote control.**
- 3** On the remote control press and hold ▶|| to start playback.  
→ playback starts and the track number is displayed for CD Audio. Filename is displayed for MP3/ WMA CDs.
- 4** Adjust the volume and sound on your remote control.



**Helpful Hint:** Replace the batteries as soon as ✨ is displayed. The display backlight only lights up if you are operating the controls on the remote control.

## ABOUT MP3/ WMA

### MP3/ WMA music files

The music compression technology MP3 (MPEG Audio Layer 3) and WMA (Windows Media Audio) reduces the digital data of an audio CD significantly while maintaining CD-like sound quality. With MP3/ WMA you can record up to 10 hours of CD-like music on a single CD-ROM.

### How to get music files

Either download legal music files from the internet to your computer hard disk or create them from your own audio CDs. For this, insert an audio CD into your computer's CD-ROM drive and convert the music using an appropriate encoder software. To achieve a good sound quality, a bit rate of 128 kbps is recommended for MP3 music files, and 96 kbps for WMA files.

### How to make a CD-ROM with MP3/ WMA files

Burn the music files from your computer hard disc on CDR or CD-RW using your CD burner. For more information, you can use the by-packed EXPANUM CD-ROM (free MUSICMATCH Jukebox software) to create your own MP3 CD.



### Helpful Hint:

- Make sure that the file names of the MP3 files end with .mp3 and WMA files and with .wma.
- Total number of music files and albums: around 500
- For more information on creating music files, please check out the free MUSICMATCH Jukebox software on the by-packed CD-ROM.
- Make sure your WMA files are not protected.

Windows Media Audio® is a registered trademark of Microsoft Corporation.  
MUSICMATCH Jukebox® is a registered trademark of Musicmatch, Inc.

All trademarks used are owned by their respective owners.

## BATTERIES

(supplied or optionally available)

You can use the following batteries with this CD-player:

- ◆ Normal batteries type **LR6, UM3** or **AA**,
- ◆ Alkaline batteries type **LR6, UM3** or **AA** (preferably Philips)
- ◆ PHILIPS rechargeable batteries, type AY3365

### ✓ Helpful Hint:

- Old and new batteries should not be combined.
- Remove batteries in the order (①, ②, ③) as shown if they are empty or if the player is not going to be used for a long time.

- ◆ For battery case only

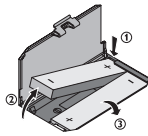

### Inserting rechargeable batteries

- 1 Push ● ▲ ● to open the CD lid.
- 2 Open the battery compartment (inside the CD player) and insert 2 x PHILIPS rechargeable batteries, type AY3365.

### Battery indication

The approximate power level of your batteries is shown in the remote control display.

- 🔋 Battery full
- 🔋 Battery two-thirds full
- 🔋 Battery one-third full
- 🔋 Battery low or empty. When the batteries are low, 🔋 flashes, and the beep tone sounds repeatedly.

**Batteries contain chemical substances, so they should be disposed of properly.**

## USING THE EXTERNAL BATTERY CASE (AA batteries not included)

The external battery case allows you to:

- increase playtime by using fully charged rechargeable batteries and new AA alkaline batteries at the same time.
- have a convenient backup power supply if your rechargeable batteries are flat. Operate the set on just 2 x AA batteries instead.

- 1 Push on **PUSH/ OPEN** to open the battery case, and lift off the case cover as indicated.
- 2 Insert 2 alkaline batteries, type AA/ LR6/ UM3 with correct polarity, and replace the case cover.
- 3 Connect the battery case to the EXT BATT jack on the set.

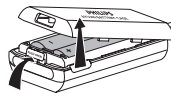

### ✓ Helpful Hint:

- When using the external battery case, avoid jolting the player and swinging the case. Sudden movements may cause damage to the external battery connection and pose a hazard.
- This player includes a motor mechanism that extends battery lifetime by varying the motor's rotation rate. Motor noise may increase when the rate changes. If the noise bothers you, use the AC/DC adapter to power the player. The motor rotation rate does not change when operating on AC power.

## Recharging the ECO-PLUS NiMH battery on board

Recharging works only on players supplied with the rechargeable ECO-PLUS NiMH battery AY3365.

- 1 Insert the rechargeable ECO-PLUS NiMH battery AY3365.
- 2 Connect the power adapter to the 4.5V DC jack of the player and then to the wall outlet.  
→ 🔋 Charging appears.
- Recharging stops after a maximum of 7 hours, or when you start playback.
- 3 When the battery is fully recharged, 🔋 and **Batt Full** appears in the display.

### ✓ Helpful Hint:

- It is normal for the batteries to become warm during recharging.
- If the batteries become too warm, recharging will be interrupted for approximately 30 minutes.
- To ensure proper recharging on board, take care that contacts are clean.
- Use only the ECO-PLUS NiMH battery AY3365.

### Handling instructions

- Recharging already charged or half-charged batteries will shorten their lifetime. We therefore recommend that you let the rechargeable ECO-PLUS NiMH battery run till it is completely empty before you recharge it.
- To avoid a short circuit, do not let the battery touch any metal object.
- If the battery becomes empty soon after recharging, then either its contacts are dirty or it has reached the end of its lifetime.

## AC/ DC ADAPTER

(supplied or optionally available)

For best playback quality connect the set to AC/DC. Use only the AY3170 adapter (4.5 V/ 300 mA direct current, positive pole to the center pin). Any other product may damage the player.

- 1 Make sure the local voltage corresponds to the AC/ DC adapter's voltage.
- 2 Connect the AC/ DC adapter to the 4.5V DC jack of the player and to the wall outlet.



### ✓ Helpful Hint: Always disconnect the adapter when you are not using it.

### Battery playtime

Average playing time of 2 alkaline AA and/ or AY3365 rechargeable batteries under normal conditions:

	Audio CD	MP3/ WMA	FM Tuner
2 x AA alkaline + Ni-MH	65 hr	102 hr	108 hr
2 x AA alkaline, Power Saving mode	46 hr	70 hr	73 hr
2 x Ni-MH, Power Saving mode	20 hr	30 hr	30 hr

## PLAYING A CD

With this set you can play

- all pre-recorded audio CDs (CDDA)
- all finalized audio CDRs and CDRWs
- WMA/MP3-CDs (CD-ROMs with WMA/MP3 files)

1 Push the open **••▲••** slider to open the CD lid.

2 Insert a disc, printed side up, by pressing gently on the disc's center so that it fits onto the hub. Close the lid by pressing it down.

3 Press and hold **▶||** briefly to start playback.

→ Display shows **EXPANIMUM**. "Reading CD" will be displayed only if the reading time exceed 2 sec (MP3/WMA). For CD Audio, the current track number is displayed. For an MP3/WMA track, file name is displayed.

4 Press **▶||** briefly to interrupt playback.

→ The time where playback was interrupted blinks.

5 To resume playback press **▶||** briefly again for MP3/WMA CDs.

→ Display shows your selected display mode, or **[Filename]**

6 Press and hold **▶||** 2-3 seconds to stop playback.

→ The total number of tracks, the track types (CD, WMA, MP3), the number of albums on an WMA/MP3-CD and the total playing time (of an audio disc only) are displayed.

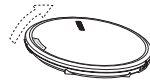

## PLAYING A CD

7 Press and hold **▶||** 2-3 seconds to switch off the CD player.

8 To remove the disc, hold it by its edge and press the hub gently while lifting the disc.

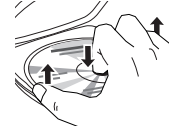

### Helpful Hint:

- After pressing **▶||** it may take some time until the first MP3/WMA track is played.
- By default, playback begins from the exact point when last switched off.
- If a CD-Recordable (CD-R) or a CD-Rewritable (CD-RW) is not recorded properly, **Unfinalized CD** is displayed, indicating that the CD has not been finalized. In that case, use **FINALIZE** on your CD recorder to complete the recording.
- When playing a CD, please note that it can take 3-5 seconds after pressing **▶||** for sound reproduction to start.
- Playback will stop if you open the CD lid.
- While the CD is paused, the elapsed play time flashes in the display.

## VOLUME, BEEP, DBB

### VOLUME

#### Volume adjustment

- Adjust the volume by pressing **VOLUME +/-** (up or down).



### DBB

#### Bass adjustment (remote control only)

1 Press **DBB** once or more to select the bass enhancement options:

- **DBB 1** moderate bass enhancement is activated.
- **DBB 12** strong bass enhancement is activated.

2 Press **DBB** again to switch off the bass enhancement options.

→ **DBB 1** or **DBB 12** disappears.

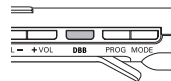

### BEEP

#### Acoustic feedback (remote control only)

Acoustic feedback is a beep signal that is heard when buttons on the set or remote control are pressed. Also, when the set or remote control is in pause mode or the battery power is low, it beeps at intervals.

1 Keep **DBB** pressed for 2 seconds to switch the beep either on or off:

- **Beep on** is displayed: Beep is switched on.
- **Beep off** is displayed: Beep is switched off.



## SELECTING A TRACK AND SEARCHING

### Selecting and searching on all discs

#### Selecting a track during playback

- Briefly press **◀◀** or **▶▶** once or several times to skip to the beginning of the current, previous or subsequent track.
- Playback continues with the selected track.



#### Searching for a passage during playback

1 Keep **◀◀** or **▶▶** pressed to find a particular passage in backward or forward direction.

→ Searching starts and playback continues at a low volume. For CD audio tracks the search speeds up after 2 seconds.

2 Release the button at the desired passage.

→ Normal playback continues.

**Helpful Hint:** During **◀◀** or **▶▶** searching is only possible within the current track.

### Selecting on WMA/MP3-CDs

#### Selecting an album during playback

- On the remote control, briefly press **ALBUM +/-** once or several times to skip to the first track of the current, previous or subsequent album.
- The first track of the selected album is played.



#### Selecting a track during playback

1 Keep **ALBUM +/-** pressed to skip quickly to previous or subsequent MP3 tracks.

→ Skipping starts and speeds up after 5 seconds.

2 Release the button at the desired track.

→ Playback continues with the selected track.

**Helpful Hint:** To skip from track to track at low speed, use **◀◀** or **▶▶**.

## SELECTING DIFFERENT PLAY OPTIONS – MODE (remote control only)

- Press **MODE** repeatedly during playback or stop to select either:
  - Shuffle album once (MP3/WMA only)
  - Shuffle all tracks of a disc once (MP3/WMA/ CDDA)
  - Shuffle repeat album (MP3/WMA)
  - Shuffle repeat all tracks of disc (MP3/WMA/CDDA)
  - repeat one track ( MP3/WMA/CDDA)
  - repeat Album ( MP3/WMA)
  - repeat all tracks ( MP3/WMA/CDDA)
- Playback starts in the selected mode after 2 seconds.
- To return to normal playback, press **MODE** repeatedly until the play option icons e.g. and disappear.

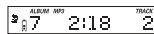
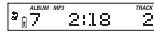

## DISPLAY INFORMATION (for WMA/MP3 tracks only)

- During playback, press and hold **MODE** 3 seconds to activate the display option mode. Press **MODE** briefly again, once or more to change and select your display option:
  - Filename:** the track's file name
  - Album:** the album's folder name
  - Title:** the track's title (if this ID3 tag information is available)
  - Artist:** the artist's name (if this ID3 tag information is available)
  - the track type and the elapsed playing time
  - Playtime:** the elapsed playing time, album number and track number.

### **Helpful Hint:**

The ID3 tag is part of an WMA/MP3 file and contains various track information such as the track's title or the artist's name. Complete the ID3 tag information with your MP3 encoder software before burning the WMA/MP3-CD.

## PROGRAMMING TRACK NUMBERS (remote control only)

You can select up to 50 tracks and store them in the memory in a desired sequence. You can store any track more than once.

- Select a track with **◀◀** or **▶▶**.
- Press **PROG** to store the track.  
→ **PROG** is shown and **P** with the number of stored tracks is displayed.
- Select and store all desired tracks in this way.
- If necessary press **▶▶** to stop normal playback. Press **▶▶** to start playback of the program.  
→ Playback of the program starts. **PROG** indication appears.

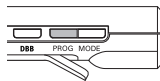

### **Clearing the program**

- If necessary press **▶▶** for 2-3 seconds to stop playback.
- Press **▶▶** 2-3 seconds to clear the program.  
**Cleared** is displayed once.



### **Helpful Hint:**

The program will also be cleared if you interrupt the power supply or open the CD lid or if the set switches off automatically. After storing 50 tracks, **Prog full** is displayed.



## ESP / POWERSAVING MODE

With a conventional portable CD-player you might have experienced that the music stopped e.g. when you were jogging. The **Electronic Skip Protection (ESP)** prevents loss of sound caused by light vibrations and shocks. Continuous playback is ensured. However ESP does not prevent playback interruptions during vigorous running. **It also does not protect the unit against any damage caused by dropping!**

- To give you optimum playback and help save battery energy, the powersave mode is selected automatically.
- No **ESP** indication:
    - when player operating on AC adapter power. **ESP** option deactivated. Optimum sound quality available.
  - **ESP** :
    - in battery operation when **ESP** mode is automatically activated.
    - when the player is free from vibration, powersaving is activated.
  - **OOPs**:
    - maximum **ESP** time exceeded. Playback skips but will resume optimum playback when the player is free from vibration.

### **840 SEC MAGIC ESP**

#### Average playing times when ESP skip protection activated:

840s	WMA	(64kbps, equivalent of up to 3 tracks)
420s	MP3	(128kbps, equivalent of up to 3 tracks)
180s	Audio CD	

## FM TUNER



### Switching radio on/off

- Press FM/  once or more to switch the radio on/off.
  - Display shows briefly **Radio on** or **Radio off** respectively.













Use the remote control or set to tune to any FM station automatically or manually.

### Tuning to radio stations automatically

- Press and hold  or  for at least 2 seconds.
  - Display shows briefly **Searching**. The radio tunes to a station with sufficient strength and radio play starts. The FM frequency is displayed.
- Repeat searching until you find the desired radio station.



### Tuning to radio stations manually

- Keep  or  pressed.
  - Release  or , then briefly press  or  again when you are close to the desired frequency.
  - Briefly press  or  repeatedly until you reach the desired frequency.
    - Radio play starts. The FM frequency is displayed.
- To switch from radio play to CD play, press .
  - Press  to switch the radio off.

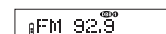

### **Helpful Hint:**

- **To improve reception:** The headphone wire is used as an FM antenna. If necessary, move it for optimum reception.
- Tuner operation is not affected if you open the CD lid to change a disc.

## LOCK

You can lock the buttons of the set/ remote control respectively by switching the slider to **LOCK**. With **LOCK** activated, you can avoid accidental activation of other functions.

- Switch the slider to **LOCK** to activate **LOCK**.
  - All buttons are locked. **Hold** is shown when you press any button on the set / remote control respectively. If the set is locked and switched off, **Hold** will be shown only when pressed .
- To deactivate **LOCK**, switch the slider to **OFF** or **UNLOCK**.



## ENVIRONMENTAL INFORMATION

- All redundant packing material has been omitted. We have done our utmost to make the packaging easily separable into two materials: cardboard (box) and polyethylene (bags, protective foam sheet).
- Your set consists of materials which can be recycled if disassembled by a specialized company. Please observe the local regulations regarding the disposal of packing materials, dead batteries and old equipment.

## FM TUNER

### Storing radio stations

You can store up to 30 radio stations. Select a preset number 1-30.

- Tune to a desired radio station and press **PROG** briefly.
- Press **PROG** while **PROG** is blinking to confirm the storage.
  - **PROG**, the FM frequency and the preset number of the stored station are displayed.
- Store all desired stations this way.

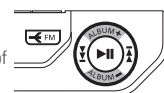
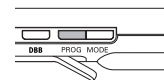

### **Helpful Hint:**

Already stored stations can be recognized by a preset number.

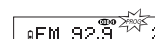

### Tuning to a stored radio station

- Press **ALBUM + / -** repeatedly if necessary to select the preset number of the desired radio station.
  - Radio play starts. The FM frequency and the preset number (P1-30) of the stored station are displayed.

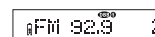

## TROUBLESHOOTING

**WARNING:** Under no circumstances should you try to repair the unit yourself as this will invalidate the warranty. If a fault occurs, first check the points listed, before taking the unit for repair. If you are unable to solve a problem by following these hints, consult your dealer or service center.

### The CD player has no power, or playback does not start

- Check that your batteries are not dead or empty, that they are inserted correctly, that the contact pins are clean.
- Your adapter connection may be loose. Connect it securely.

### The indication Please insert CD is displayed

- Check that the CD is clean and correctly inserted (label-side upward).
- If your lens has steamed up, wait a few minutes for this to clear.



### The indication Unfinalized CD is displayed

- CD-RW (CD-R) was not recorded properly. Use FINALIZE on your CD-recorder.

### The indication Hold is on and/or there is no reaction to controls

- If **LOCK** is activated, then deactivate it.
- Electrostatic discharge. Disconnect power or remove batteries for a few seconds.

### The CD skips tracks

- The CD is damaged or dirty. Replace or clean the CD.
- ,  or **PROG** is active. Switch off whichever is on.

### No sound or bad sound quality.

- pause might be active. Press .
- Loose, wrong or dirty connections. Check and clean connections.
- Volume might not be appropriately adjusted. Adjust the volume.
- Strong magnetic fields. Check player's position and connections. Also keep away from active mobile phones.