

Register your product and get support at [www.philips.com/welcome](http://www.philips.com/welcome)

DCB2020

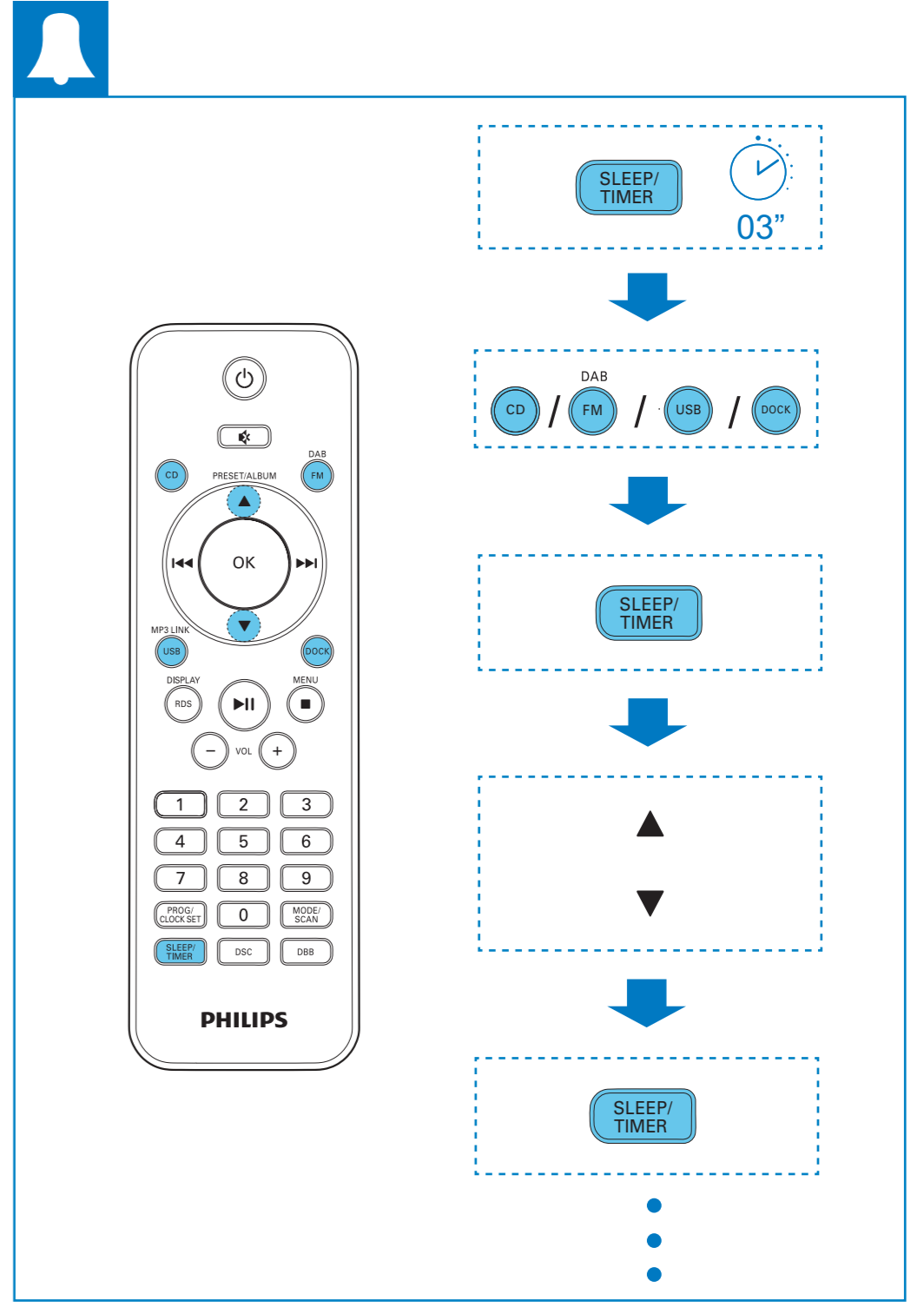

# Quick start guide

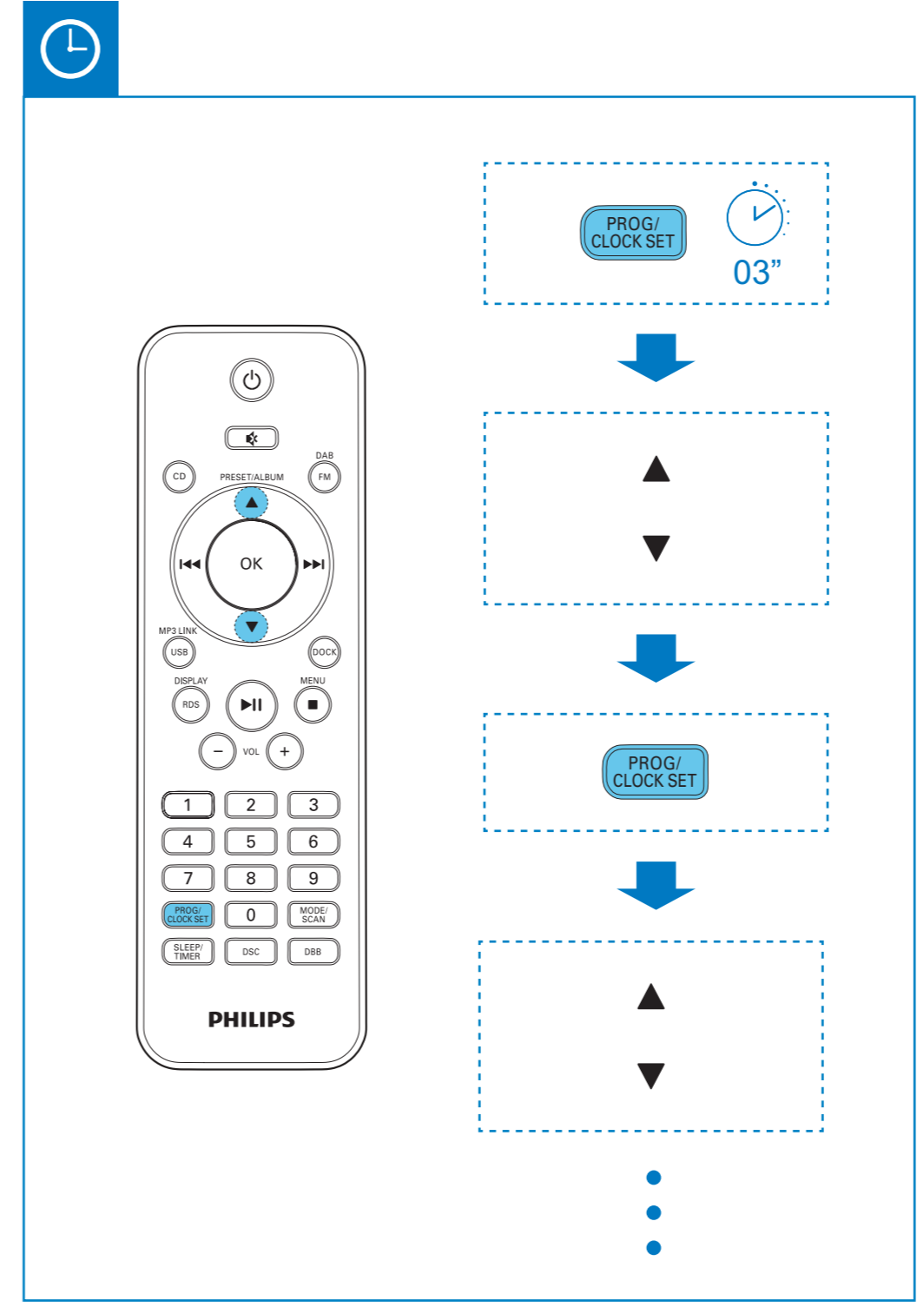
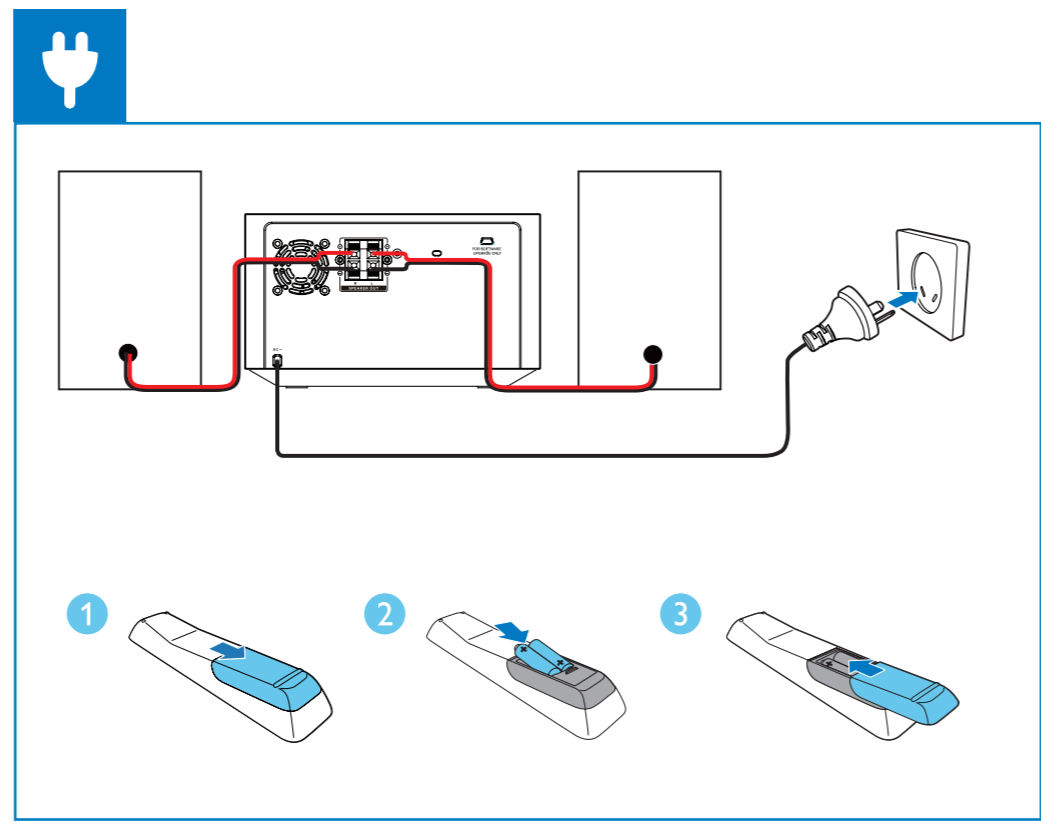
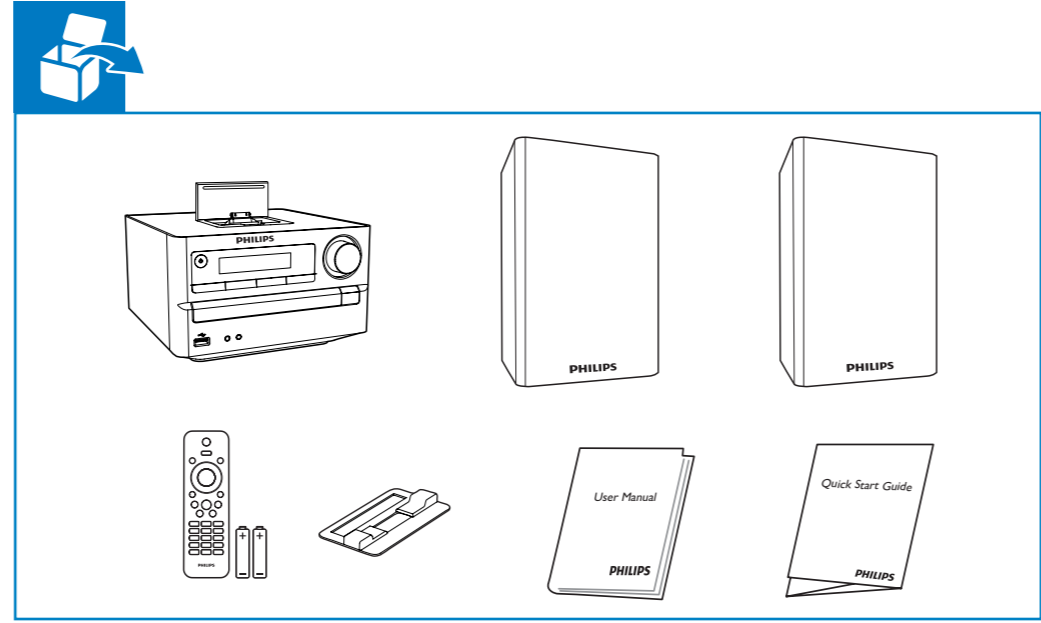

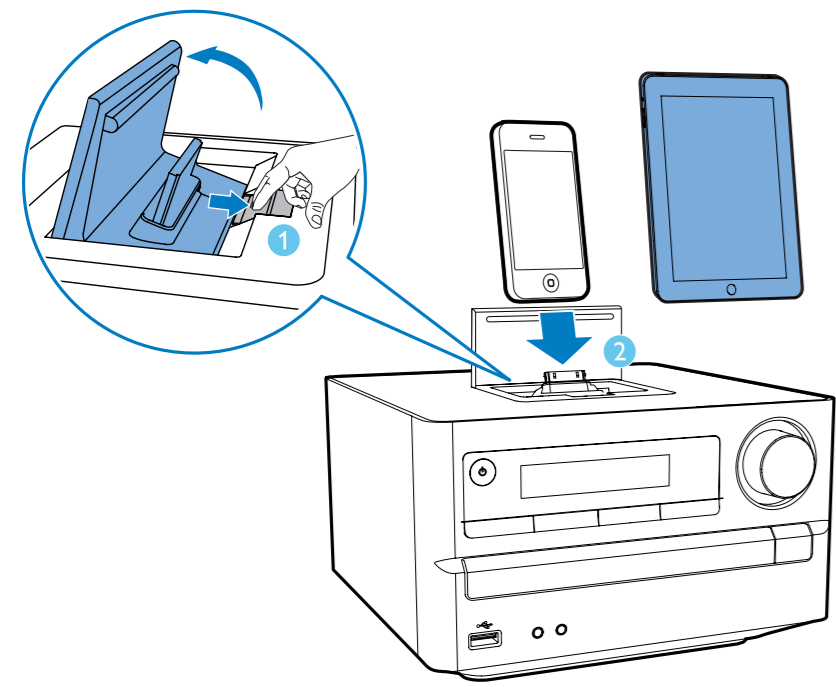

Use the bumper to keep your iPad 2 stable if it is not in a case.

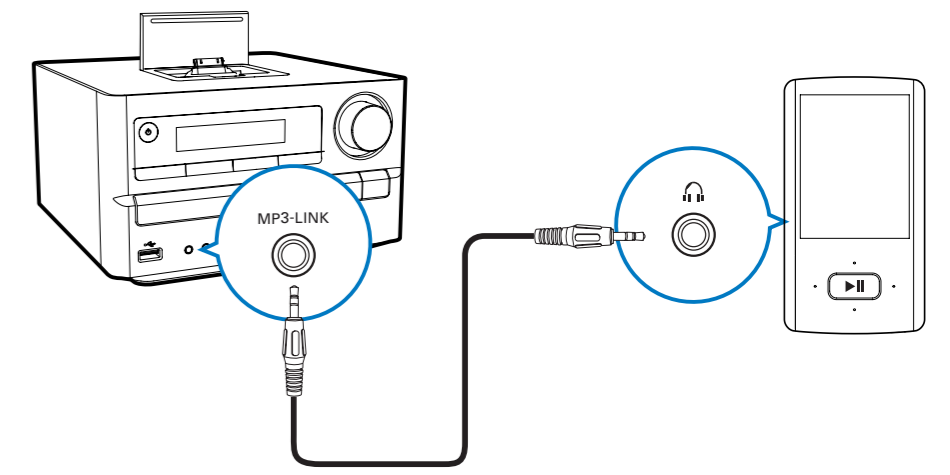
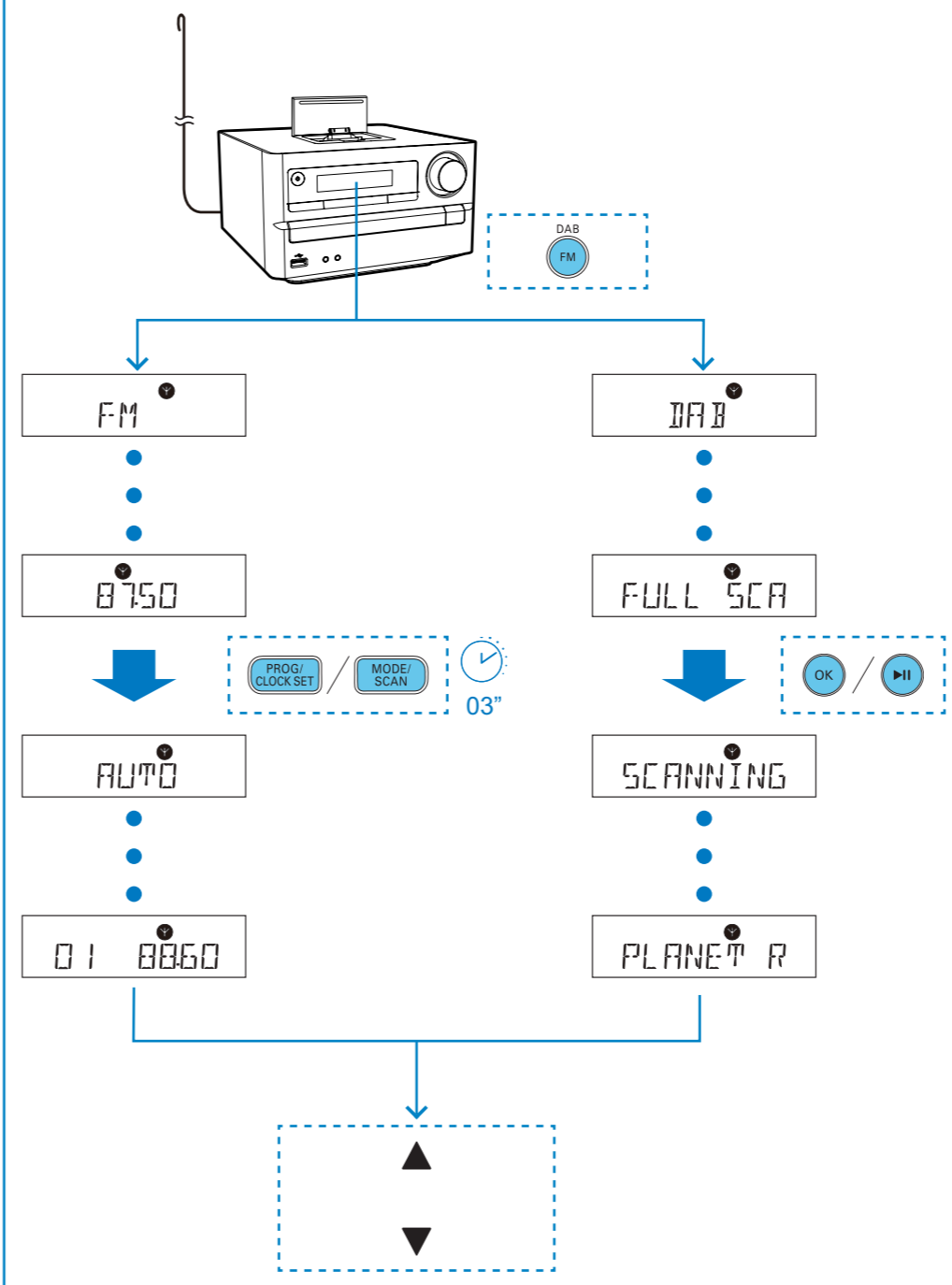
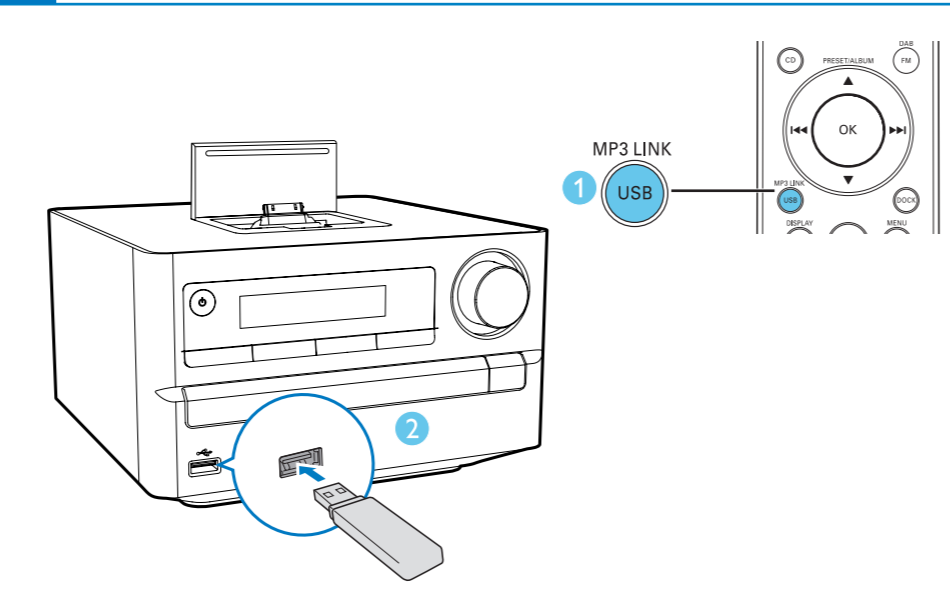
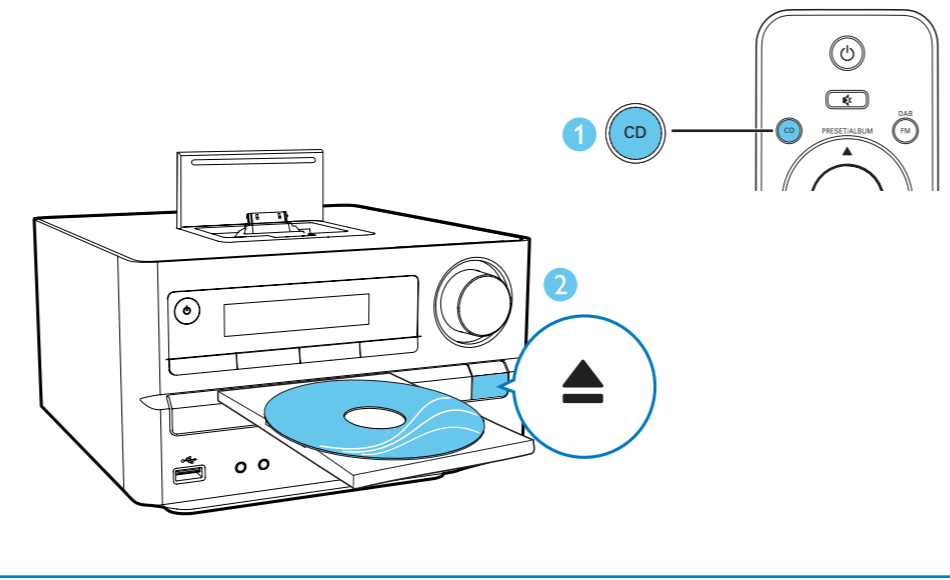
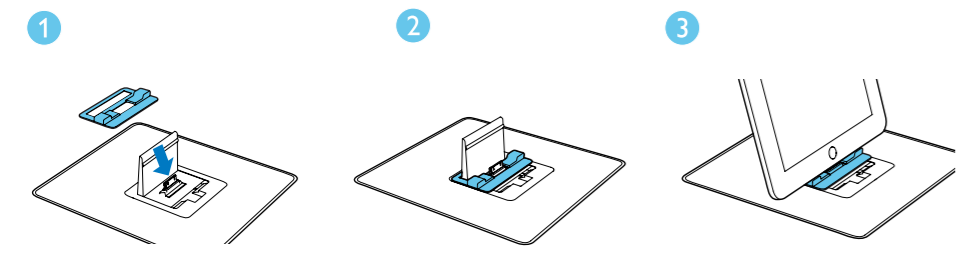

2012 © Koninklijke Philips N.V.  
All rights reserved.  
DCB2020\_79\_QSG\_V1.0

