

Always there to help you

Register your product and get support at
www.philips.com/welcome

HTB3510
HTB3540
HTB3570



Quick start guide

PHILIPS



EN Before using your product, read all accompanying safety information

HI अपने उत्पाद का उपयोग करने के पहले, साथ वाली सभी सुरक्षा जानकारी को पढ़ें



HTB3510

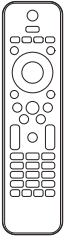

FM Antenna

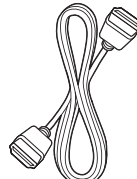

HDMI

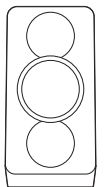
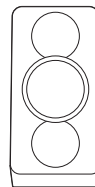
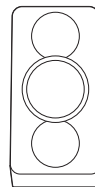
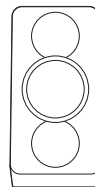
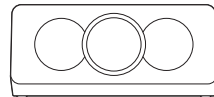
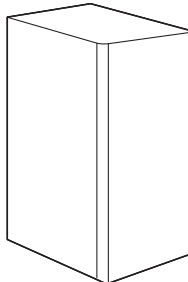
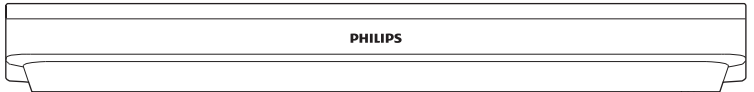
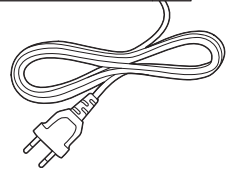

1

EN Stand mount the speakers
Applied to HTB3540 and HTB3570 only

HI स्पीकर्स को स्टैंड पर रखें
केवल HTB3540 और HTB3570 पर लागू

1

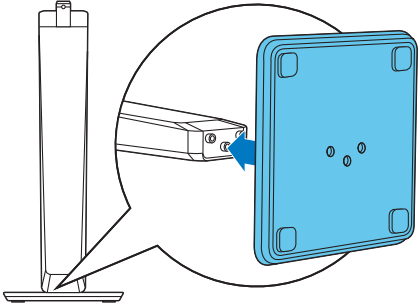

2

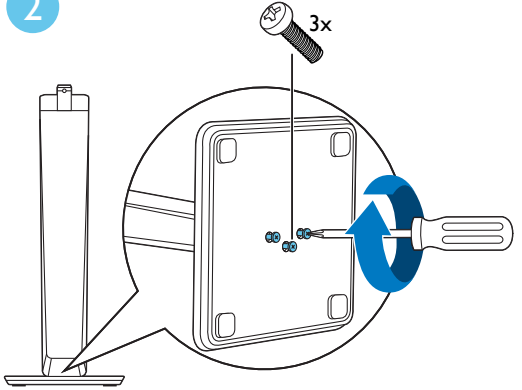

3

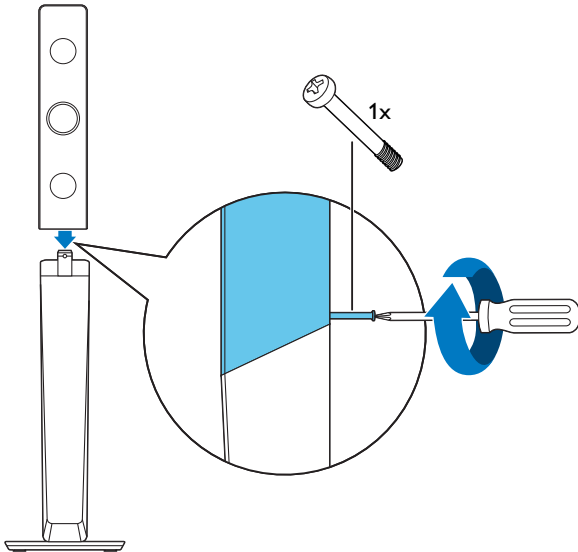

2

EN Connect and position the home theater

HI होम थिएटर को कनेक्ट और स्रि करे

HTB3510

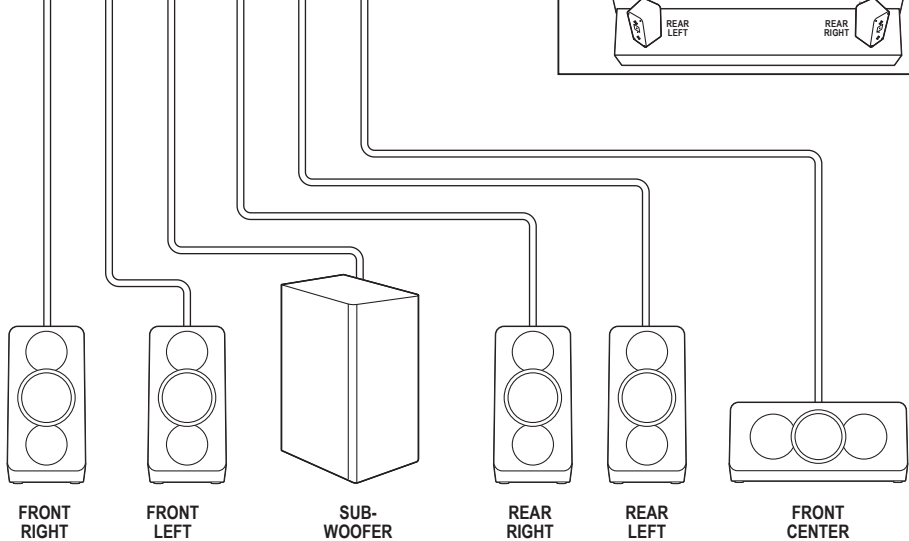
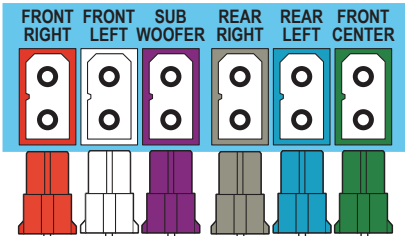
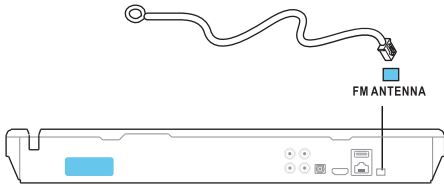

HTB3540

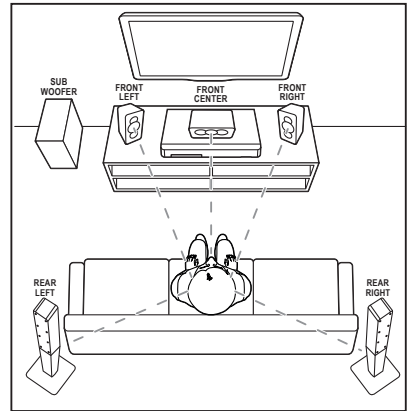
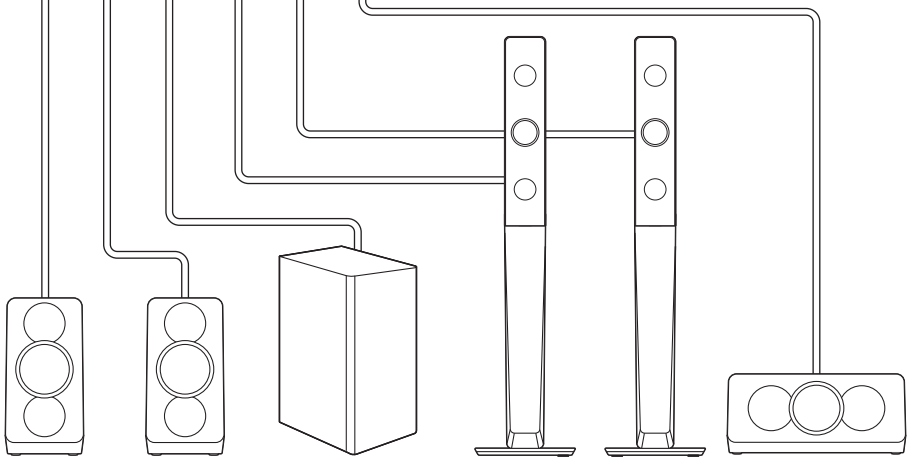
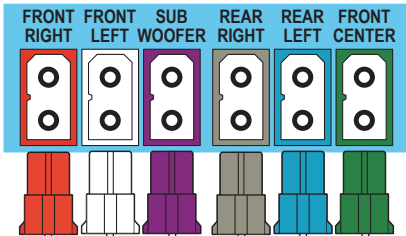
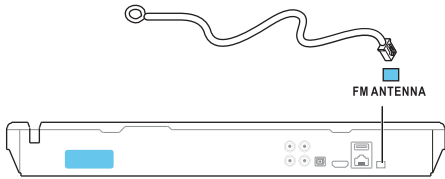

FRONT RIGHT

FRONT LEFT

SUB-WOOFER

REAR RIGHT

REAR LEFT

FRONT CENTER

HTB3570

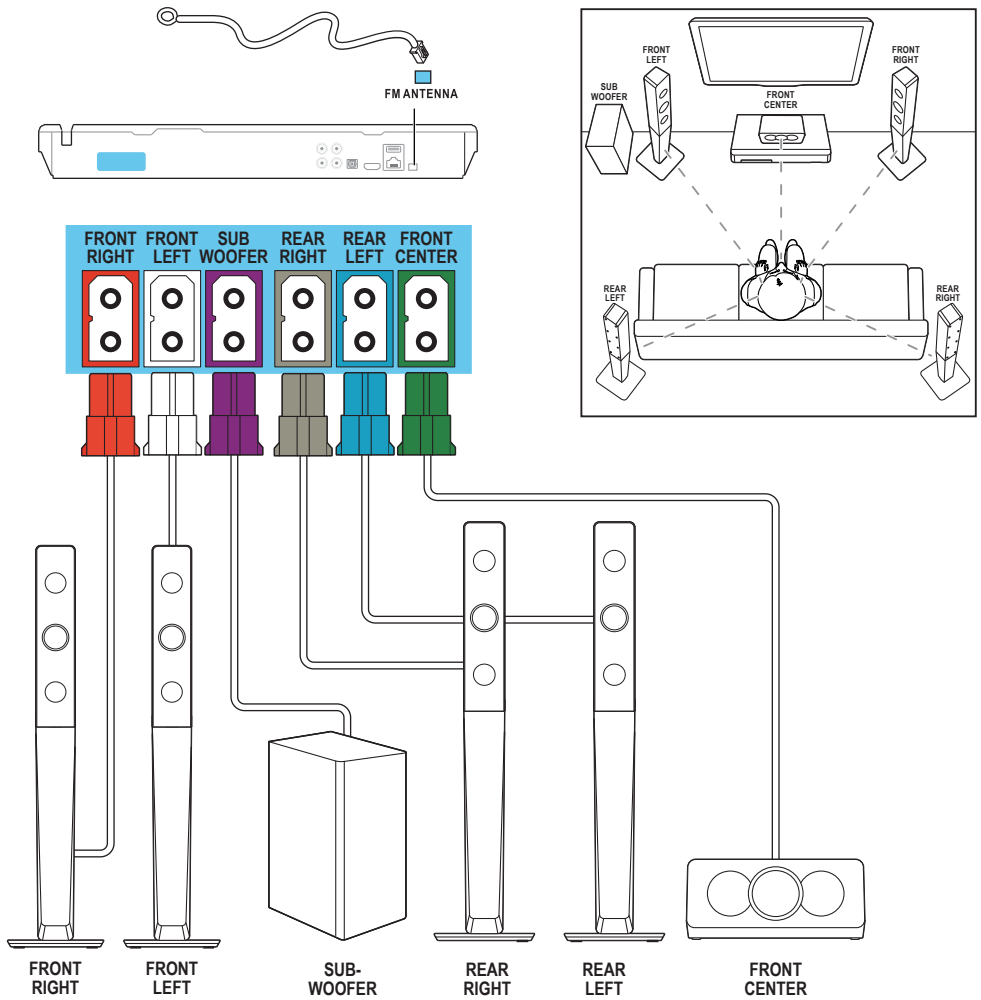

3

EN Connect to TV in one of these ways

HI इन तरीकों में से एक के द्वारा TV से कनेक्ट करें

HDMI ARC

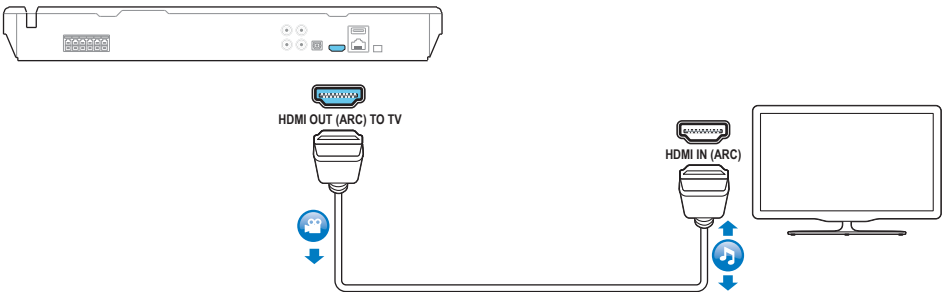

HDMI + OPTICAL

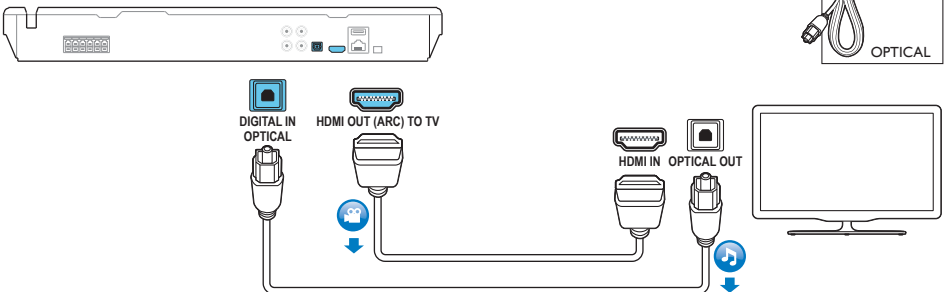

HDMI + COAXIAL

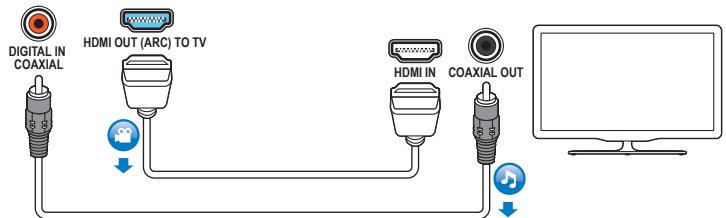

HDMI + AUDIO L/R

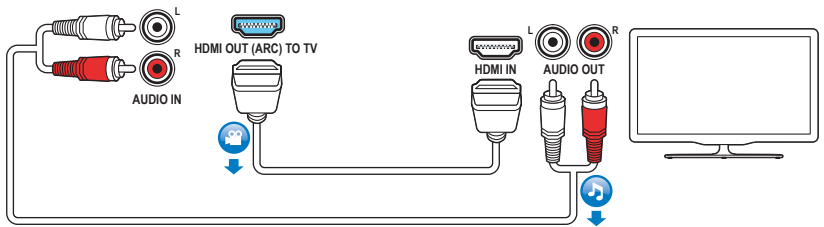
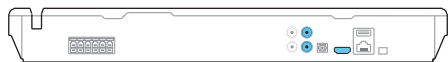

4

EN Switch on the home theater

HI होम थिएटर को स्विचि ऑन करें

1

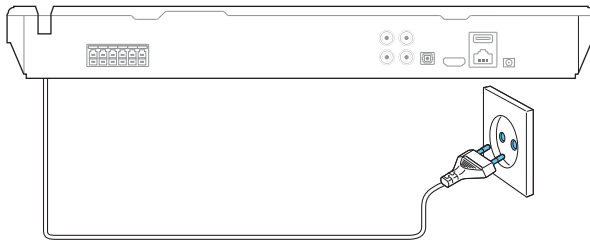

2

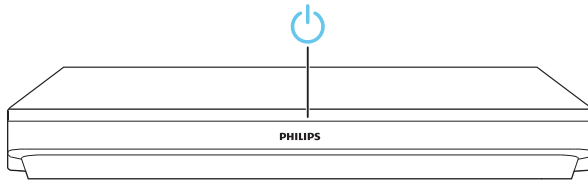

3

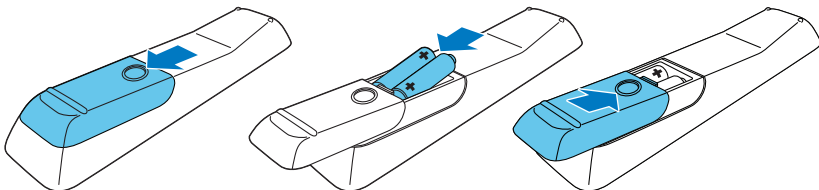

5

EN Complete the first time setup

HI पहली बार के सेटअप को पूरा करें

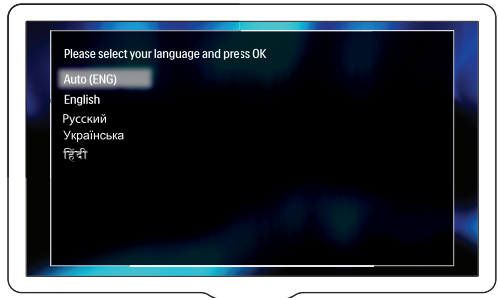
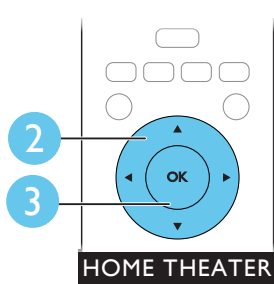
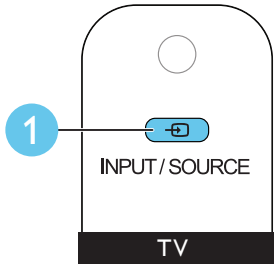

6

EN Use your home theater

HI अपने होम थिएटर का उपयोग करें

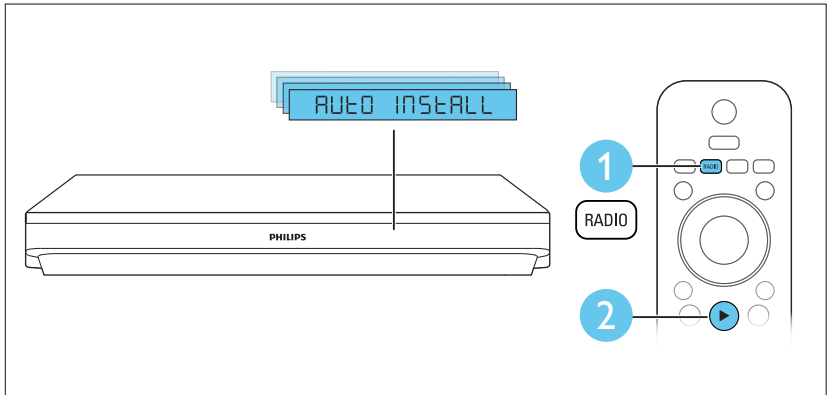
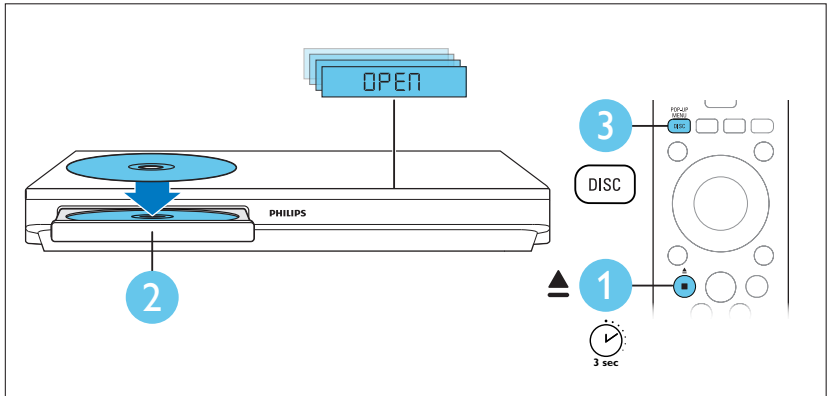

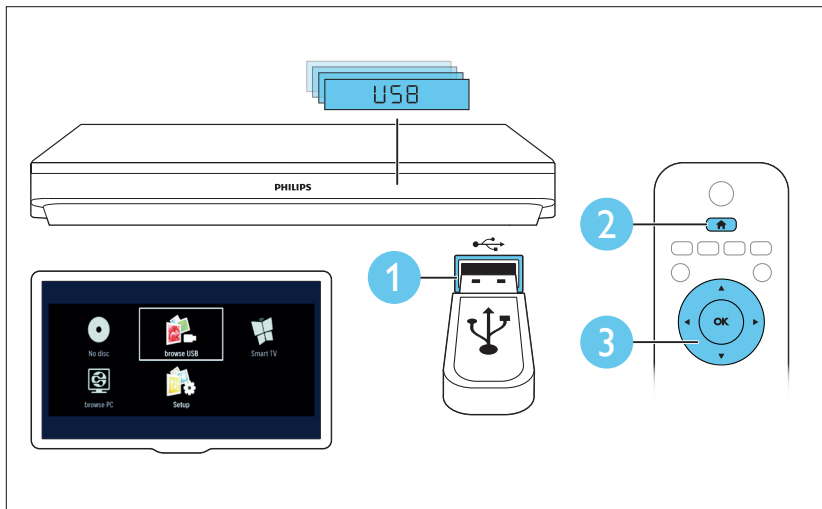
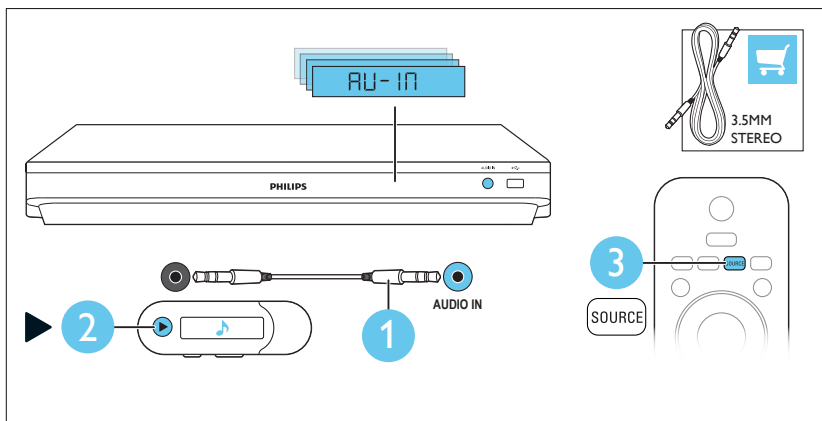

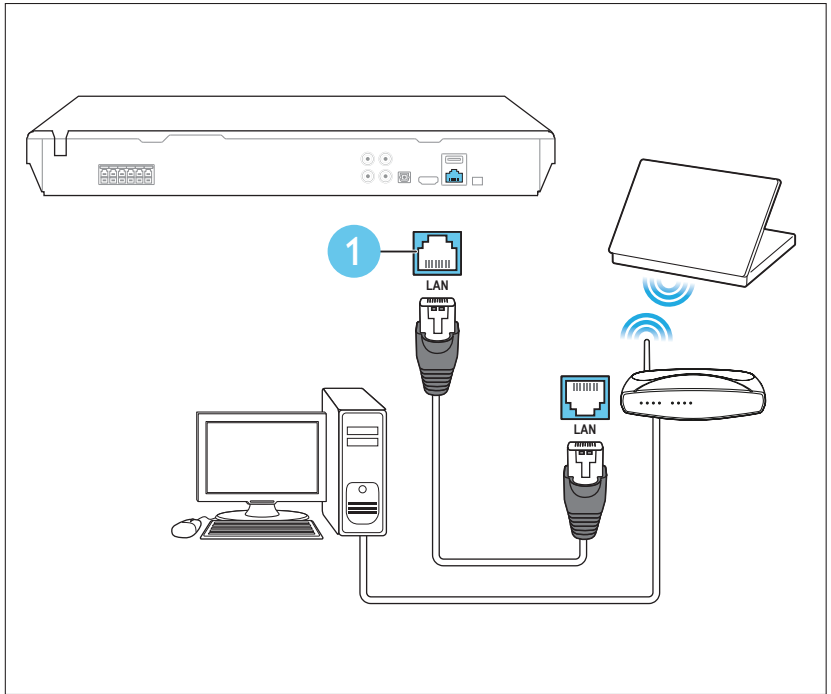



Specifications are subject to change without notice
© 2013 Koninklijke Philips Electronics N.V.
All rights reserved.

HTB3510/3540/3570_94_QSG_V1.0

