

Register your product and get support at  
[www.philips.com/welcome](http://www.philips.com/welcome)

AS140



# User manual

**PHILIPS**

# Contents

<b>1 Important</b>	<b>2</b>	<b>5 Listen to FM radio</b>	<b>21</b>
Safety	2	Tune to FM radio stations	21
		Store FM radio stations automatically	21
		Store FM radio stations manually	21
		Select a preset radio station	21
<b>2 Your Docking System for Android™</b>	<b>3</b>	<b>6 Other features</b>	<b>22</b>
Introduction	3	Set time	22
What's in the box	3	Set alarm timer	22
Overview of the docking system	4	Set alarm	22
		Select alarm source	22
		Activate/deactivate alarm timer	22
		Snooze alarm	22
		Set sleep timer	22
		Play audio from an external device	23
		Adjust display brightness	23
<b>3 Get started</b>	<b>6</b>	<b>7 Product information</b>	<b>24</b>
Connect power	6	Specifications	24
Turn on	6	Amplifier	24
Switch to standby mode	6	Tuner	24
Select a source	6	General information	24
		<b>8 Troubleshooting</b>	<b>25</b>
		About Bluetooth device	25
<b>4 Play and charge</b>	<b>7</b>	<b>9 Notice</b>	<b>26</b>
Compatible with Android™	7	Disposal of your old product	26
Play audio through manual Bluetooth connection	7		
Play audio through auto Bluetooth connection with Philips DockStudio	8		
Install DockStudio app onto Android-powered device	9		
Activate Bluetooth with DockStudio app	11		
Sync time automatically	13		
Play audio with Philips Songbird	13		
Install Songbird on Android-powered device	14		
Install Songbird on PC	15		
Sync with PC through Philips Songbird	15		
Use more features with DockStudio	16		
Set alarm timer	16		
Set sleep timer	18		
Listen to Internet radio	18		
Dock and charge Android-powered phone	19		
Dock Android-powered phone	19		
Use dock extension	20		
Charge Android-powered phone	20		

# 1 Important

---

## Safety

- Read these instructions.
- Heed all warnings.
- Follow all instructions.
- Do not block any ventilation openings. Install in accordance with the manufacturer's instructions.
- Do not install near any heat sources such as radiators, heat registers, stoves, or other apparatus (including amplifiers) that produce heat.
- Protect the power cord from being walked on or pinched, particularly at plugs, convenience receptacles, and the point where they exit from the unit.
- Only use attachments/accessories specified by the manufacturer.
- Unplug this unit during lightning storms or when unused for long periods of time.
- Refer all servicing to qualified service personnel. Servicing is required when the unit has been damaged in any way, such as power-supply cord or plug is damaged, liquid has been spilled or objects have fallen into the unit, the unit has been exposed to rain or moisture, does not operate normally, or has been dropped.
- This unit shall not be exposed to dripping or splashing.
- Do not place any sources of danger on the unit (e.g. liquid filled objects, lighted candles).
- Where the plug of the Direct Plug-in Adapter is used as the disconnect device, the disconnect device shall remain readily operable.

## 2 Your Docking System for Android™

Congratulations on your purchase, and welcome to Philips! To fully benefit from the support that Philips offers, register your product at [www.philips.com/welcome](http://www.philips.com/welcome).

---

### Introduction

With this docking system, you can:

- enjoy audio from your Android-powered device;
- charge your phone through micro USB connector;
- listen to FM radio;
- wake up to buzzer alarm, radio, or audio in your device; and
- experience a variety of features brought by **Philips DockStudio** and **Philips Songbird** app.

---

### What's in the box

Check and identify the contents of your package:

- Main unit
- Power adapter
- Dock extension
- MP3 link cable x 1
- Quick start guide

## Overview of the docking system

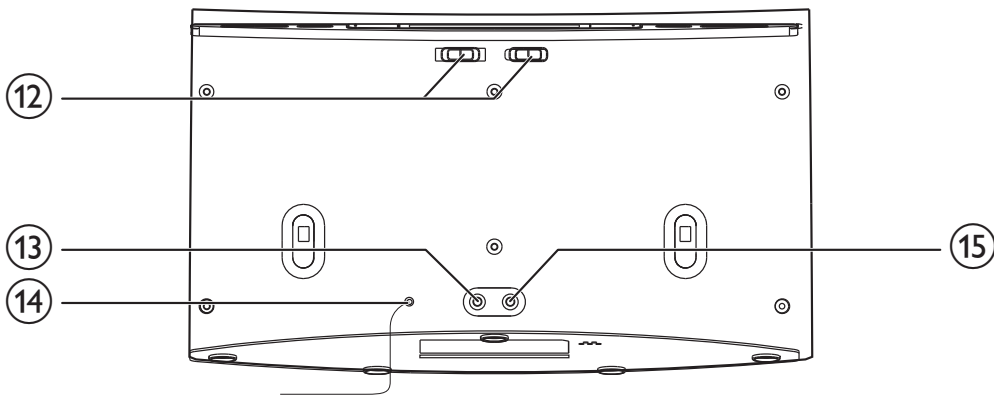
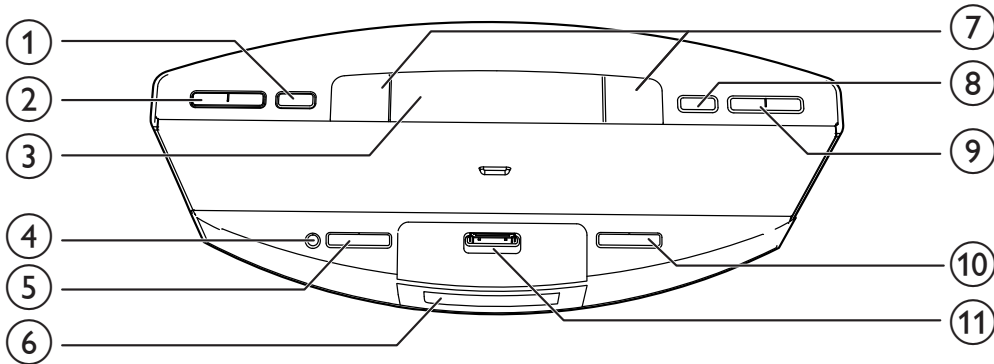

### ① SET TIME/PROG

- Set clock.
- Store FM radio stations.

### ② PRESET ▲ / ▼

- Select a preset radio station.
- Adjust hour and hour format.

### ③ SNOOZE/BRIGHTNESS

- Snooze alarm.
- Adjust display brightness.

### ④ ⏻

- Turn the docking system on or off.
- Switch the system to standby mode.

### ⑤ SOURCE

- Select a source: FM tuner, Bluetooth device, or MP3 link.

### ⑥ Display panel

- Show current information.

### ⑦ AL1/AL2

- Set alarm.
- View alarm settings.
- Activate or deactivate alarm timer.

### ⑧ SLEEP

- Set sleep timer.

### ⑨ TUNING ·◀◀ / ▶▶

- Tune to FM radio stations.
- Adjust minute.

### ⑩ VOLUME +/-

- Adjust volume.

### ⑪ Dock for Android phone

- Dock your Android-powered phone.

- ⑫ **AL1/AL2 RADIO BUZZ DOCK**
  - Select alarm source for Alarm 1 or Alarm 2.
- ⑬ **MP3 LINK**
  - Connect an external audio device.
- ⑭ **FM ANTENNA**
  - Improve FM reception.
- ⑮ **DC IN**
  - Connect power.

# 3 Get started

Always follow the instructions in this chapter in sequence.

## Connect power

### ! Caution

- Risk of product damage! Ensure that the power voltage corresponds to the voltage printed on the back or underside of the device.
- Risk of electric shock! When you unplug the power adapter, always pull the plug from the socket. Never pull the cord.

### ≡ Note

- The type plate is located on the bottom of the docking system.

Connect the power adapter to:

- the **DC IN** socket of the docking system.
- the wall socket.

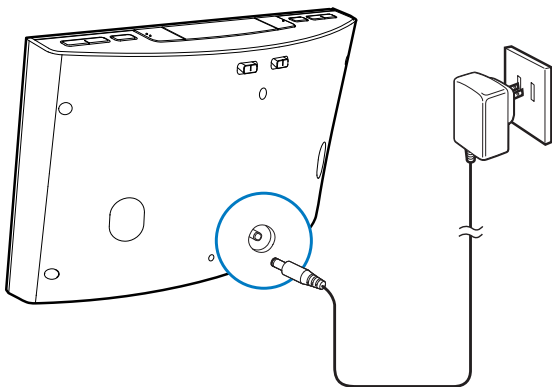

## Turn on

Press **⏻**.

- ↳ The docking system switches to the last selected source.

## Switch to standby mode

Press **⏻** again to switch the docking system to standby mode.

- ↳ **[OFF]** appears, and then the clock (if set) is displayed.

## Select a source

Press **SOURCE** repeatedly to select a source: Bluetooth, FM tuner, or MP3 link.

### ≡ Note

- When an android-powered device is docked, the system automatically switches to Bluetooth mode.

## 4 Play and charge

With this docking system, you can enjoy audio in two ways:

- through manual Bluetooth connection;
- through automatic Bluetooth connection with **Philips DockStudio** app.

### Compatible with Android™

To make full use of your docking system, your Android-powered device should satisfy the following requirements:

- With Android operation system (Version 2.1 or above);
- With Bluetooth software (Version 2.1 or above); and
- With a micro USB connector.

For other devices with micro USB connector and Bluetooth function, you can still use the docking system to do the the following:

- Charge your device through the USB connector;
- Enjoy audio through Bluetooth.



#### Tip

- For more details, go to [www.philips.com/flexidock](http://www.philips.com/flexidock).

### Play audio through manual Bluetooth connection

The docking system uses Bluetooth wireless technology to stream music from your portable device to the system.



#### Note

- Before you connect a Bluetooth device to this docking system, familiarize yourself with the Bluetooth capabilities of the device.
- Keep this docking system away from other electronic devices that may cause interference.

- 1 On your docking system, press **⏻** to activate Bluetooth.  
↳ The Bluetooth indicator **Ⓜ** blinks on the display panel.
- 2 Turn on Bluetooth function of your portable device.
  - Different devices may have different way to activate Bluetooth.

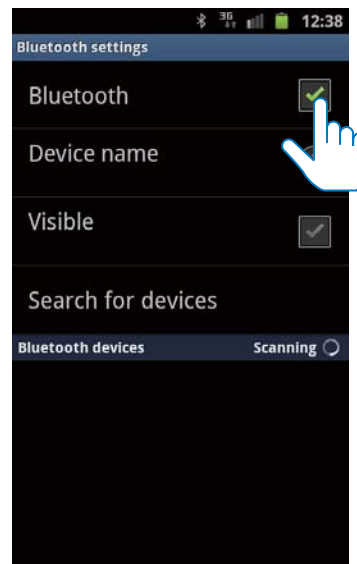



- 3 Scan Bluetooth devices that can pair with your portable device.

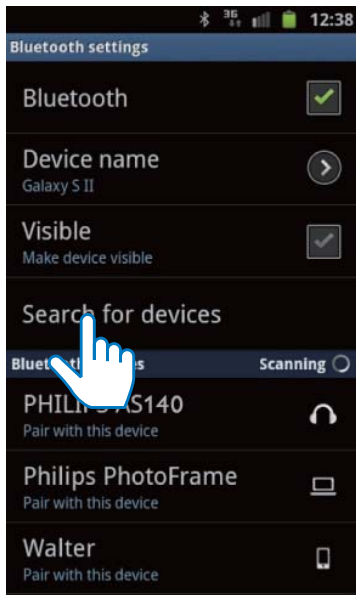

- 4 When [PHILIPS AS140] is displayed on your device, select it to start connection.  
↳ If connection is successful, you will hear double beep confirmation and find a different Bluetooth icon on the top of the screen.

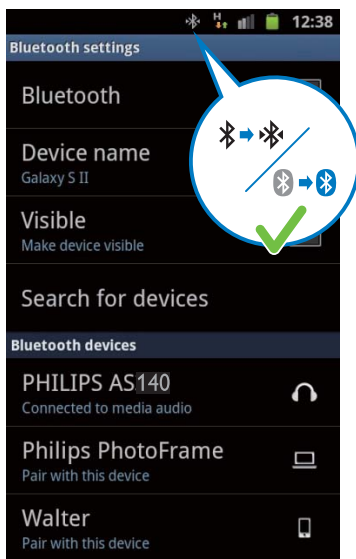

- 5 Play audio with the media player of your portable device.

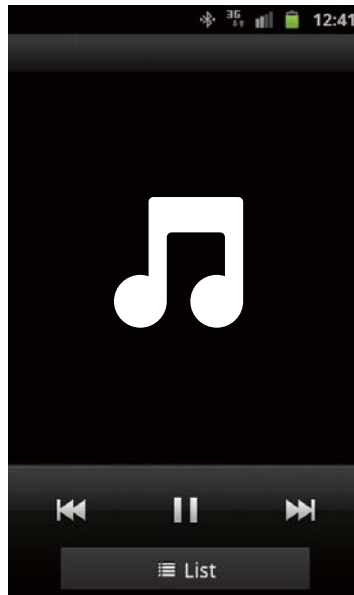

- ↳ The audio comes out through the docking system.

#### Tip

- The effective operation range between the docking system and the paired device is approximately 10 meters (30 feet).
- Any obstacle between the system and the device can reduce the operational range.

## Play audio through auto Bluetooth connection with Philips DockStudio

**Philips DockStudio** app brings a suite of new features to your docking system, including automatic Bluetooth connection, Songbird music player; Internet radio and a multi-function alarm clock. To enjoy more features, you are recommended to download and install the free app.

## Install DockStudio app onto Android-powered device

You have two ways to install **Philips DockStudio** on your Android-powered device.

### Install DockStudio app through QR code

#### Note

- Make sure that your Android-powered device is connected to the Internet.
- Make sure that your device has a barcode scanner such as "QR Droid". If not, download one from the Android market.

1 Use the barcode scanner to scan the QR code on the package or Quick Start Guide.

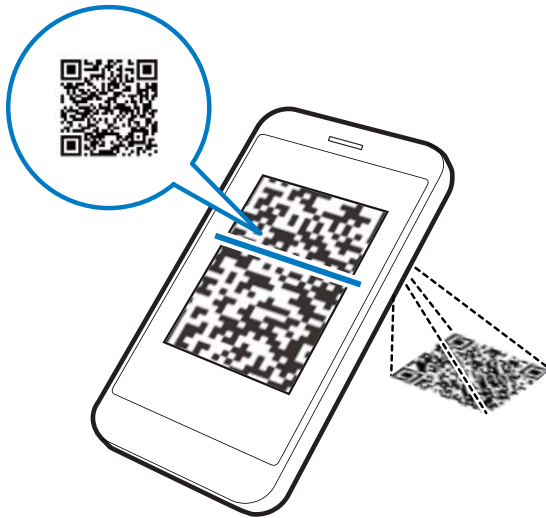

2 Follow the on-screen instructions to install **Philips DockStudio** app.



3 When installation is complete, tap **[Done]** (done).



↳ The **DockStudio** icon appears on your portable device.



### Install DockStudio app through HiMarket

You can also search **Philips DockStudio** from HiMarket directly, and then install the app.

#### Note

- Make sure that your Android-powered device is connected to the Internet.

- 1 At <http://apk.hiapk.com/>, search the "DockStudio" app.
- 2 From the search result list, find and tap **Philips DockStudio** to start downloading.

- 3 Follow the on-screen instructions to install the app.

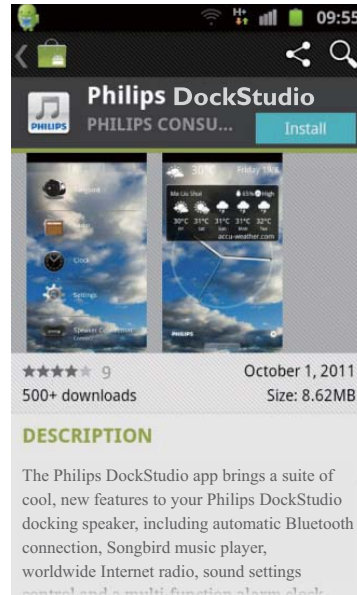

- 4 When installation is complete, tap **Done** (done).

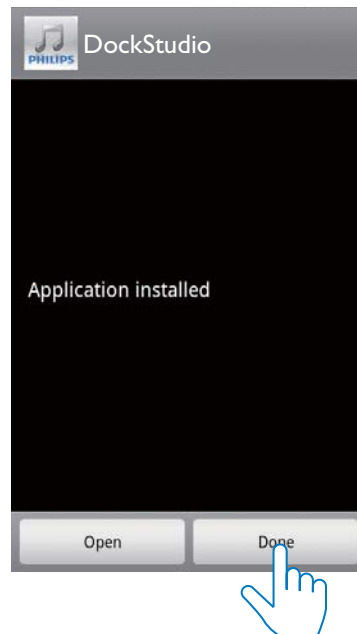

## Activate Bluetooth with DockStudio app

Philips DockStudio app helps to connect your Android-powered device and docking system through Bluetooth automatically.

### Note

- Make sure that your Android-powered device is connected to the Internet.

### First-time launch

- 1 On your docking system, press **⏻** repeatedly to select Bluetooth source.  
↳ **⏻** blinks on the display panel.
- 2 On the home screen of your device, tap the **DockStudio** icon to launch the app.



- ↳ A prompt message asking you to download **Songbird** appears.

- 3 Tap **[Cancel]** (cancel).

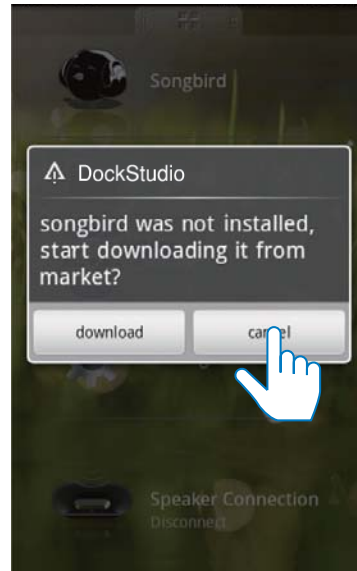

- ↳ The device starts to scan Philips devices that can be paired automatically.

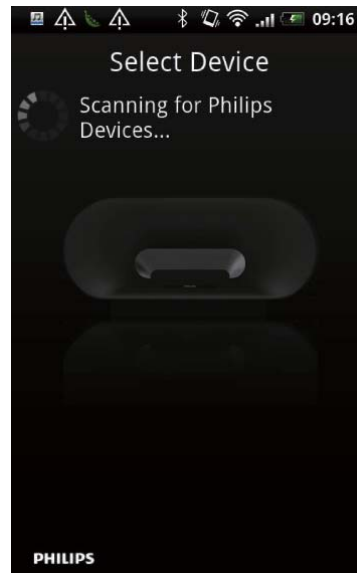

- 4 When [PHILIPS AS140] is displayed on your device, select it to start connection.  
↳ It may take a few seconds to complete the connection.

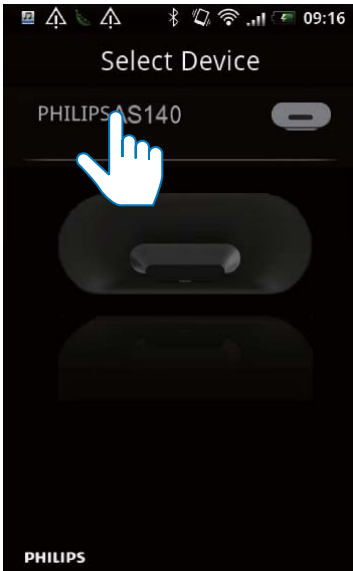

- ↳ After Bluetooth connection, a different Bluetooth icon can be found on the top of the screen.

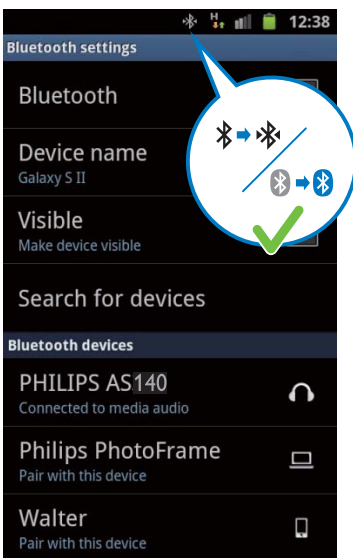

- 5 Play audio with the media player of your portable device.

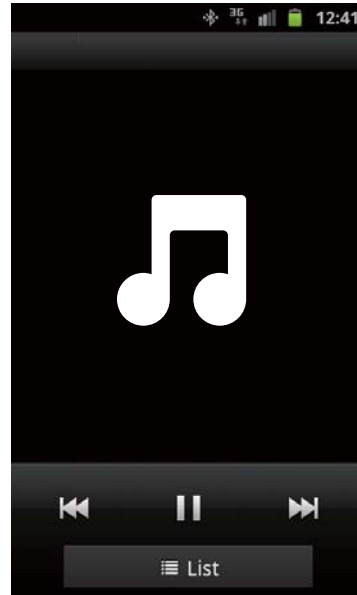

- ↳ The audio comes out through the docking system.

### Next-time launch

Next time you launch the **DockStudio** app, connect to the docking system through Bluetooth as below.

- 1 Activate the Bluetooth function of your docking system.

- 2 Launch **Philips DockStudio** and access its menu.



- 3 Tap **[Speaker Connection]** (Speaker Connection) to activate automatic Bluetooth connection.

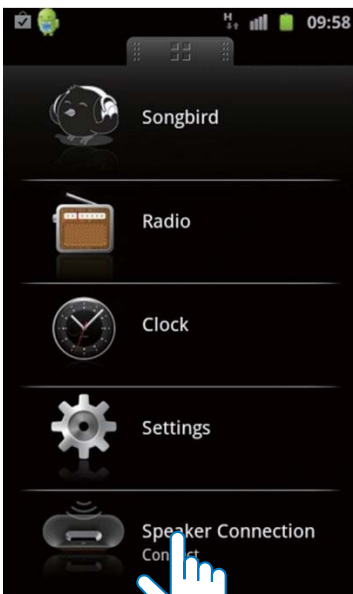

- ↳ It may take a few seconds to complete the connection.

- 4 Play audio on your portable device.  
↳ The audio comes out through the docking system.

### Sync time automatically

After you activate Bluetooth connection through **Philips DockStudio**, the docking system synchronizes time with your Bluetooth-enabled device automatically.

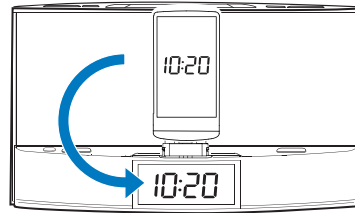

### Play audio with Philips Songbird

**Philips Songbird** is a simple, easy-to-use PC program and Android app. It lets you discover, play and sync your media from PC to your Android-powered devices seamlessly.

## Install Songbird on Android-powered device

- 1 Tap the **DockStudio** icon on your Android-powered device.



↳ The **DockStudio** menu is displayed.



- 2 Tap **[Songbird]**.

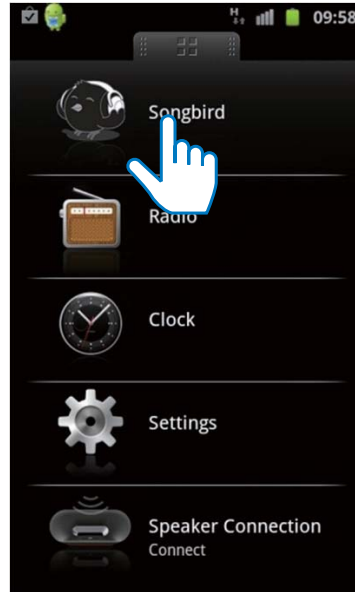

↳ You are requested to download **Songbird**.

- 3 Follow the on-screen instructions to download the app.

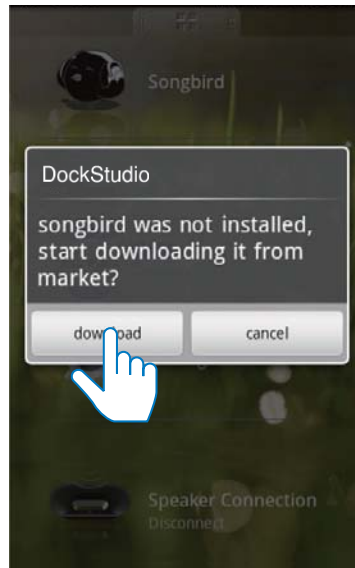

- 4 After installation, tap **[Open]** (Open) to access **Songbird** menu.



- 5 Select a track, and then tap ► to play music.

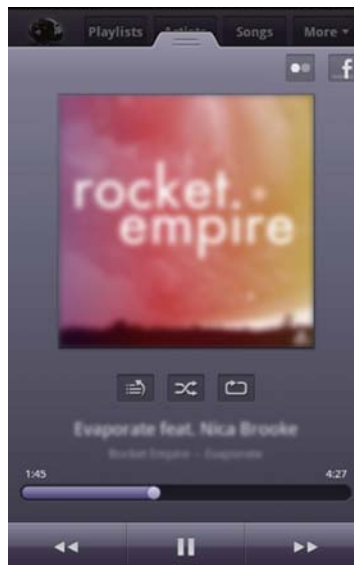
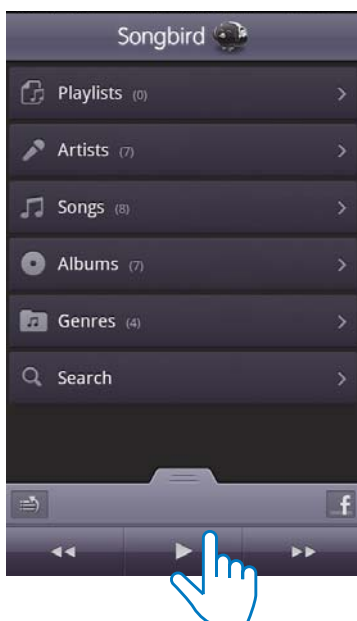

## Install Songbird on PC

- 1 Go to [www.philips.com/songbird](http://www.philips.com/songbird).
- 2 Search **Songbird**.

songbird

- 3 Download the latest **Songbird** application.
- 4 Follow on-screen instructions to install **Philips Songbird** on your PC.

## Sync with PC through Philips Songbird

### Note

- Make sure that you have turned on the USB storage.

- 1 On your PC, launch **Philips Songbird**.



- 2 Connect your Android-powered device to PC with a USB cable. Wait until the device is recognized by the **Songbird**.
  - ↳ On **Philips Songbird**, the device is displayed when it is recognized by the PC.

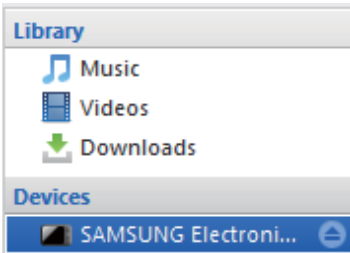

- ↳ If it is the first time you connect the device to **Philips Songbird**, a pop-up screen appears. Select auto sync as prompted.



- ↳ The device synchronizes with **Philips Songbird** automatically.

If you didn't select auto sync, you can sync with **Songbird** manually.

- 1 Select the device under **Devices**.

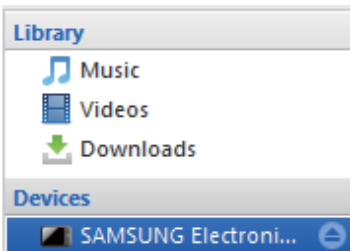

- 2 Select **Manual** or **Auto**.



- 3 Click **Sync**.
  - ↳ If you have selected auto sync, auto sync starts automatically when you connect the device to the PC.

## Use more features with DockStudio

With **Philips DockStudio**, you can also listen to Internet radio, set alarm timer and sleep timer.

### Set alarm timer

With **Philips DockStudio**, you can set multiple alarms and know the latest weather. It even alerts you when weather conditions are suitable for your favorite outdoors activity.

- 1 Launch the app.

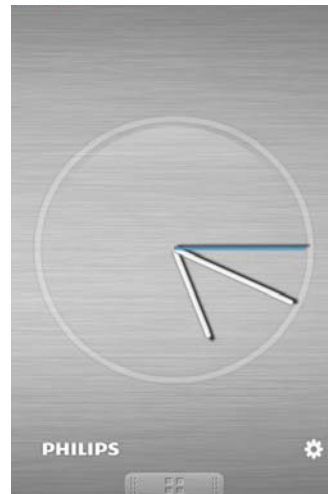

- 2 Tap the icon  to access clock setting menu.

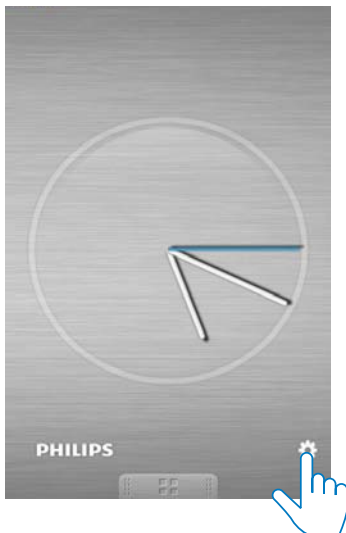

- 3 Tap **[Alarm settings]** (Alarm settings).

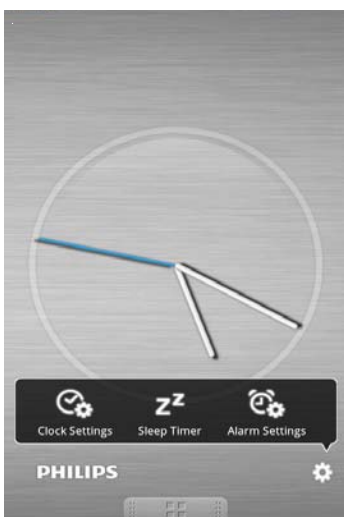

- 4 Tap **+** to access alarm setting menu.

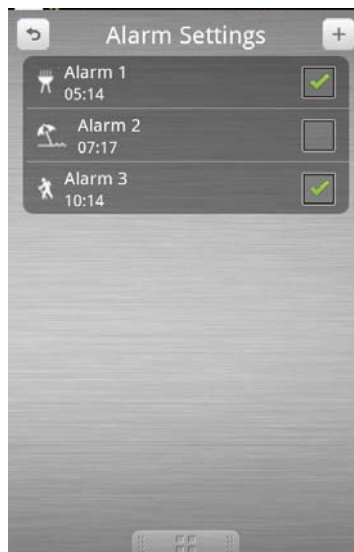

- 5 Set the alarm, and tap **[Save]** (Save) on the top right of the screen.

↳ The new alarm is saved and displayed on the screen.

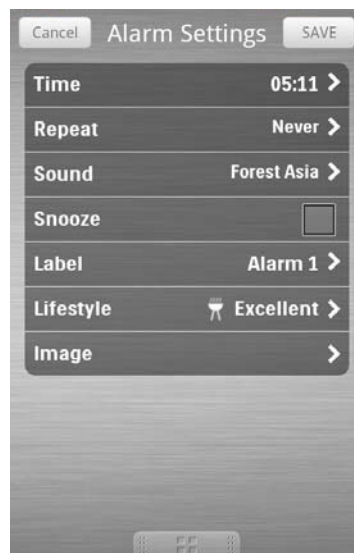

#### Note

- From the **[Lifestyle]** (Lifestyle) tab, you can select your preferred sport and weather (excellent, good, or fair). The alarm will not ring if the weather is not good enough.

---

## Set sleep timer

- 1 Launch **Philips DockStudio**.

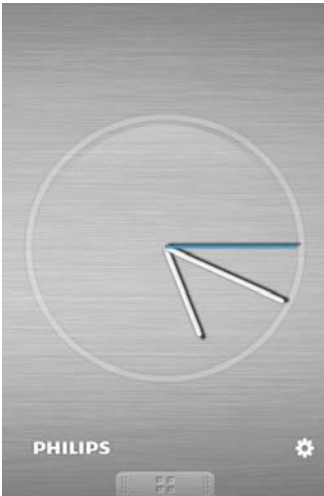

- 2 Tap the icon  to access the sleep timer menu.

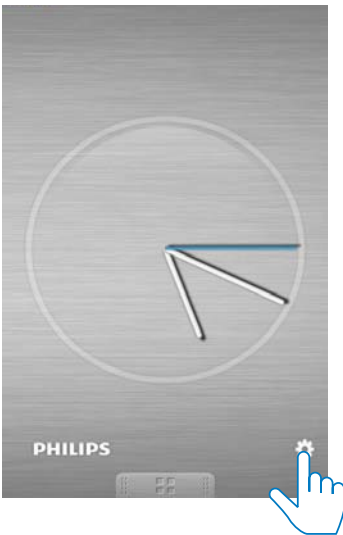

- 3 Select a time period for the sleep timer, and then tap **[Start]** (Start).

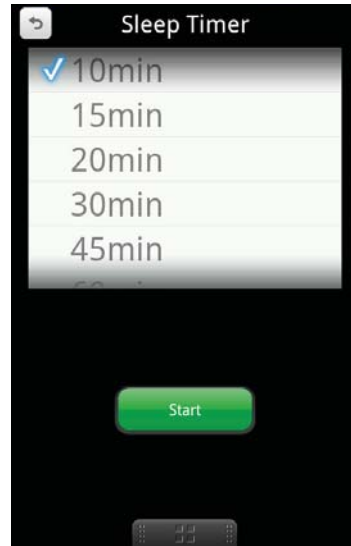

### Note

- This function only works with **Philips Songbird**.

---

## Listen to Internet radio

- 1 Connect your Android-powered device and the docking system through Bluetooth.
- 2 Open **Philips DockStudio** to go to the main menu.

- 3 Tap **[Radio]** (Radio) on the screen.

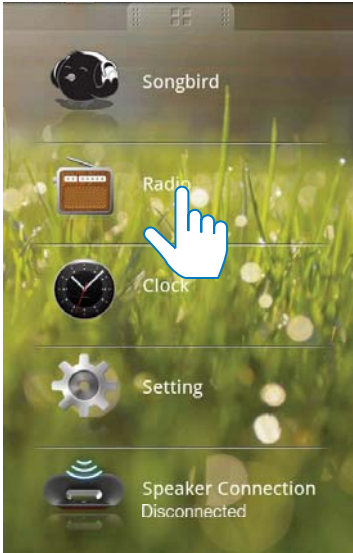

- 4 Search a radio station in the search bar.



- 5 Select a radio station from the search result list.  
 ↳ The radio station begins to broadcast.

## Dock and charge Android-powered phone

### Dock Android-powered phone

To charge your Android-powered phone, you need to dock it in the docking system first.

- 1 Check the orientation of the micro USB connector on your Android-powered phone.

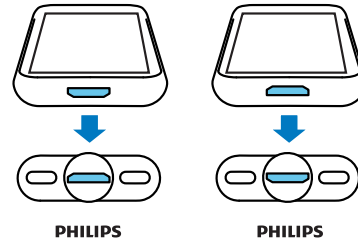

- ↳ If your USB connector has a cover, flip it outwards.

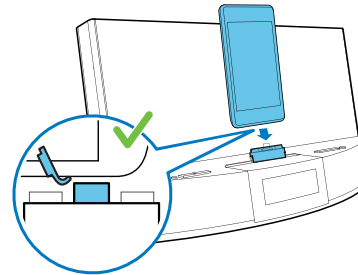

- 2 If necessary, rotate the USB connector on the docking system, and then place your Android-powered phone into the dock.

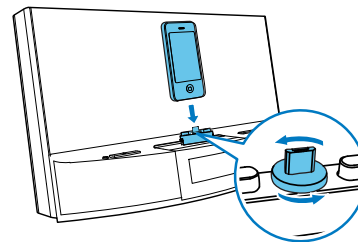

- 3** Adjust the bumpers on both sides of the connector to stabilize the phone.

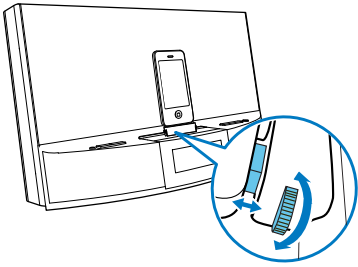

- 4** Slide the connector to place your phone in the middle of the docking system.

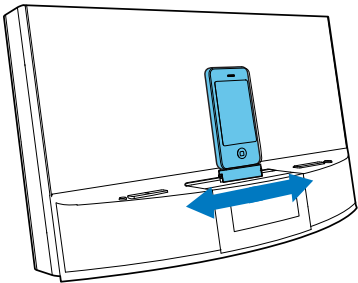

- 2** Place the dock extension onto the dock.

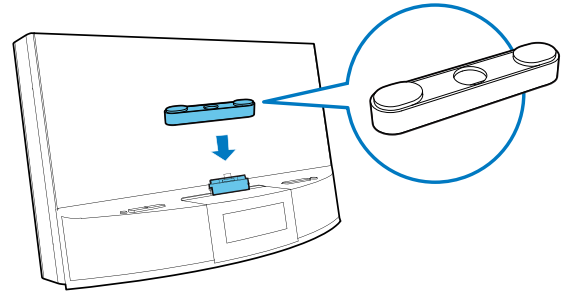

- 3** Dock your phone.

---

### Charge Android-powered phone

When the docking system is connected to power, your docked phone starts charging automatically even in standby mode.

#### Note

- If the micro USB connector is located at the top, and you are using Android system of version 2.3 or above, screen auto-rotation is available.

---

### Use dock extension

If the USB connector on your phone is close to the edge, the supplied dock extension can balance the docked phone, as illustrated.

- 1** Adjust the slide knobs to make both bumpers at the lowest position.

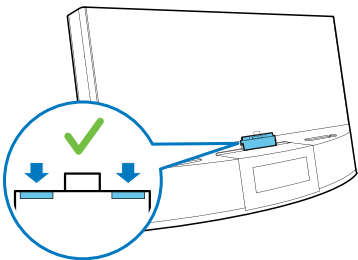

## 5 Listen to FM radio

### Tune to FM radio stations



#### Tip

- Position the antenna as far as possible from TV, VCR, or other radiation source.
- For better reception, fully extend and adjust the position of the antenna.

- 1 Press **SOURCE** repeatedly to select FM tuner source.
- 2 Press and hold **◀◀ / ▶▶** for two seconds.
  - ↳ The docking system tunes to a station with strong reception automatically.
- 3 Repeat step 2 to tune to more radio stations.

#### To tune to a station manually:

- 1 Press **◀◀ / ▶▶** repeatedly until you find optimal reception.

### Store FM radio stations automatically



#### Note

- You can store a maximum of 20 FM radio stations.

In tuner mode, press and hold **PROG** for two seconds.

- ↳ The docking system stores all the available FM radio stations and broadcasts the first available station automatically.

### Store FM radio stations manually

- 1 Tune to an FM radio station.
- 2 Press **PROG**.
  - ↳ The preset number begins to blink.
- 3 Press **▲ / ▼** repeatedly to select a number.
- 4 Press **PROG** again to confirm.
- 5 Repeat steps 1 to 4 to store other stations.



#### Note

- To remove a pre-stored station, store another station in its place.

### Select a preset radio station

In tuner mode, press **▲ / ▼** repeatedly to select a preset number.

# 6 Other features

---

## Set time

- 1 Press **⏻** to switch the docking system to standby mode.
- 2 Press and hold **SET TIME** for two seconds.  
↳ The hour and minute digits begin to blink.
- 3 Press **▲ / ▼** and **⏪ / ⏩** repeatedly to set the hour and minute.
- 4 Press **SET TIME** to confirm.  
↳ **[12H]** or **[24H]** begins to blink.
- 5 Press **▲ / ▼** to select 12/24 hour format.
- 6 Press **SET TIME** to confirm.  
↳ The set time is displayed.

---

## Set alarm timer

---

### Set alarm

In standby mode, you can set two alarms to ring at different time.

 **Note**

- Make sure that you have set the clock correctly.

- 1 Press and hold **AL1/AL2** for two seconds to activate alarm setting mode.  
↳ The hour and minute digits begin to blink.
- 2 Press **▲ / ▼** and **⏪ / ⏩** repeatedly to set the hour and minute.
- 3 Press **AL1/AL2** to confirm.

---

### Select alarm source

 **Note**

- For alarm sound, you can select buzzer, your last listened radio channel, or the latest played track in your Android-powered device.

Adjust **AL1/AL2 RADIO BUZZ DOCK** control to select alarm source for both alarms.

 **Note**

- If **DOCK** is selected as alarm source, make sure that you have docked your device into the docking system.

---

### Activate/deactivate alarm timer

- 1 Press **AL1/AL2** to view alarm settings.
- 2 Press **AL1/AL2** again to activate or deactivate the alarm timer.  
↳ The alarm icon appears if alarm timer is on and disappears if it is off.
  - To stop the ringing alarm, press the corresponding **AL1/AL2**.  
↳ The alarm repeats ringing for the next day.

---

### Snooze alarm

When alarm sounds, press **SNOOZE**.

- ↳ The alarm snoozes and repeats ringing nine minutes later.

---

### Set sleep timer

This docking system can switch to standby mode automatically after a preset period. Press **SLEEP** repeatedly to select the sleep timer period (in minutes).

- ↳ When the sleep timer is activated, **zZ** appears.

### To deactivate the sleep timer

Press **SLEEP** repeatedly until **[OFF]** (off) appears.

---

## Play audio from an external device

You can listen to audio from an external device through this device.

- 1 Connect the MP3 link cable to:
  - the **MP3 LINK** socket.
  - the headphone socket of an external device.
- 2 Press **SOURCE** repeatedly to select MP3 link source.  
↳  is displayed.
- 3 Play audio in the external device (see the device's user manual).

---

## Adjust display brightness

Press **BRIGHTNESS** repeatedly to select different brightness levels.



# 7 Product information

## Note

- Product information is subject to change without prior notice.

Dimensions	
- Main Unit (W x H x D)	290 x 160 x 113 mm

Weight	
- With Packing	2.0 kg
- Main Unit	1.4 kg

## Specifications

### Amplifier

Rated Output Power	2 X 5W RMS
--------------------	------------

### Tuner

Tuning Range	FM: 87.5 - 108 MHz
--------------	--------------------

Sensitivity	
- Mono, 26dB S/N Ratio	FM: <22 dBf

Search Selectivity	FM: <28 dBf
--------------------	-------------

Total Harmonic Distortion	FM: <2%
---------------------------	---------

Signal to Noise Ratio	FM: >55 dB
-----------------------	------------

### General information

AC Power	Model: AS180-070-AB250; Input: 100-240 V ~, 50/60Hz, 0.7A; Output: 7V = 2.5A
----------	--

Operation Power Consumption	<35 W
-----------------------------	-------

Standby Power Consumption	<1 W
---------------------------	------

Max. load of Android output	5V = 1A
-----------------------------	---------

# 8 Troubleshooting



## Warning

- Never remove the casing of this device.

To keep the warranty valid, never try to repair the system yourself.

If you encounter problems when using this device, check the following points before requesting service. If the problem remains unsolved, go to the Philips Web page ([www.philips.com/support](http://www.philips.com/support)). When you contact Philips, make sure that the device is nearby and the model number and serial number are available.

### No power

- Ensure that the AC power plug of the unit is connected properly.
- Ensure that there is power at the AC outlet.

### No sound or poor sound

- Adjust the volume of your docking system and Android-powered device.
- Make sure that your Android-powered device is connected to the docking system through Bluetooth.

### Poor radio reception

- Increase the distance between the unit and your TV or VCR.
- Fully extend the FM antenna.

### Clock/timer setting erased

- Power has been interrupted or the power plug has been disconnected.
- Reset the clock/timer.

### Alarm does not work

- Set the clock/alarm correctly.

## About Bluetooth device

**Music playback is unavailable on the system even after successful Bluetooth connection.**

- The device cannot be used with the system to play music.

**The audio quality is poor after connection with a Bluetooth-enabled device.**

- The Bluetooth reception is poor. Move the device closer to the system or remove any obstacle between the device and the system.

**Cannot connect with the system.**

- The device does not support the profiles required for the system.
- The Bluetooth function of the device is not enabled. Refer to the user manual of the device for how to enable the function.
- The system is not in the pairing mode.
- The system is already connected with another Bluetooth-enabled device. Disconnect that device or all other connected devices and then try again.

**The paired device connects and disconnects constantly.**

- The Bluetooth reception is poor. Move the device closer to the system or remove any obstacle between the device and the system.
- For some devices, the Bluetooth connection may be deactivated automatically as a power-saving feature. This does not indicate any malfunction of the system.

# 9 Notice

Any changes or modifications made to this device that are not expressly approved by Philips Consumer Lifestyle may void the user's authority to operate the equipment.

---

## Disposal of your old product

Your product is designed and manufactured with high quality materials and components, which can be recycled and reused.

Never dispose of your product with other household waste. Please inform yourself about the local rules on the separate collection of electrical and electronic products and batteries. The correct disposal of these products helps prevent potentially negative consequences on the environment and human health.

Please visit [www.recycle.philips.com](http://www.recycle.philips.com) for additional information on a recycling center in your area.

### **Environmental information**

All unnecessary packaging has been omitted. We have tried to make the packaging easy to separate into three materials: cardboard (box), polystyrene foam (buffer) and polyethylene (bags, protective foam sheet.)

Your system consists of materials which can be recycled and reused if disassembled by a specialized company. Please observe the local regulations regarding the disposal of packaging materials, exhausted batteries and old equipment.



Specifications are subject to change without notice  
© 2012 Koninklijke Philips Electronics N.V.  
All rights reserved.

AS140\_93\_CCR\_V1.0

