



# PHILIPS

Use this simple and quick guide to get started listening to your favorite music.

## A Connections-MCM595

**DEMO MODE**

To turn OFF (IDEMO STOP) button

Press & HOLD button for 5 seconds

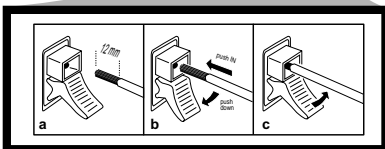
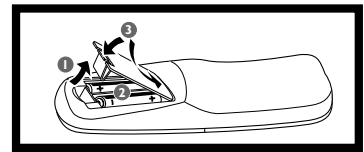
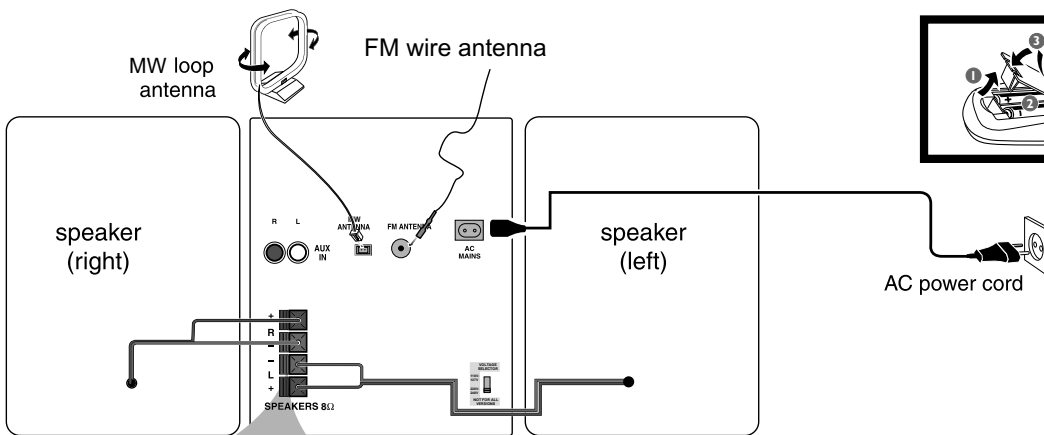
*Please note that the voltage selector located at the rear of this system is preset at 220V from the factory. For countries that operate at 110V-127V, please adjust to 110V-127V before you switch on the system.*

**Software installation-USB PC Link**

1. Turn on your PC and insert the installer disc into your PC's CD-ROM drive.
2. The installation guide will appear automatically. If not, double click the setup.exe under Windows Explorer.
3. Select your desired language from the list and select **Install Software**.
4. Connect the USB cable provided to the PC and Audio system and press USB PC Link button.
5. Follow the instructions as prompted on the screen.

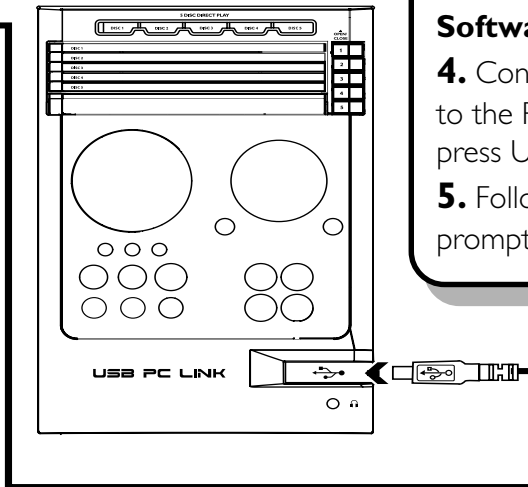
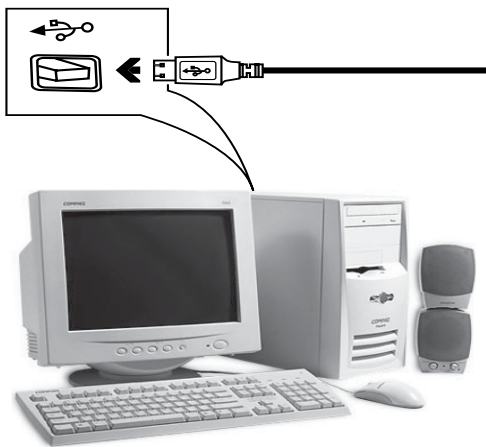

Philips Sound Agent 2 is only applicable for Windows 2000/XP.

## B Tuner installation- Plug and Play

- 1 When you turn on the mains supply, "AUTO INSTALL - PRESS PLAY" is displayed. Or in standby mode, press and hold **▶ ||** on the system, until the message is displayed.
- 2 Press **▶ ||** on the system to start installation automatically. "INSTALL" is displayed. Once completed, the last tuned radio station (or the first available RDS station) will be played.

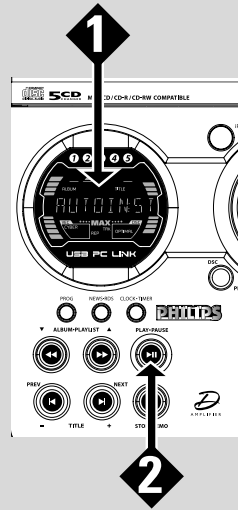

## C Timer Operations

- 1 Press and hold **CLK/TIMER** (or **CLOCK•TIMER** on main unit) until "SELECT CLOCK OR TIMER" is displayed.
- 2 Press **▶ |** to change the display to "TIMER" and press **CLOCK•TIMER** again to confirm.
- 3 Press **CD** or **TUNER** or **USB PC LINK** to select the wake-up source.
- 4 Press **◀◀** or **▶▶** (for hours) and **◀** or **▶** (for minutes) repeatedly to set the wake-up time.
- 5 Press **CLOCK•TIMER** to store the setting.

### To exit without storing the setting

- Press **■** on the system.

**Note:**  
Before setting the timer, ensure that the clock is set correctly.

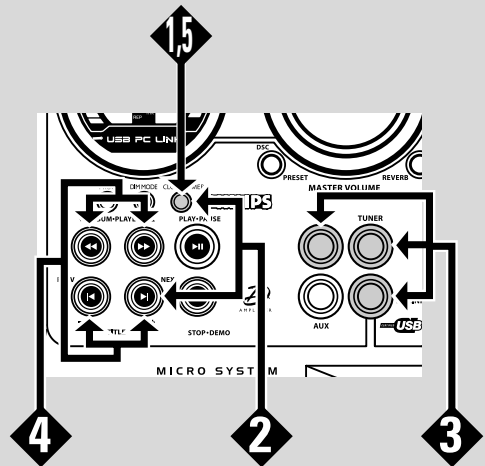

**For more detailed instructions, see the following pages in the User Guide.**

USB PC Link .....	12~14
Philips Sound Agent 2 .....	14
Basic Operations .....	15~16
Disc Operations .....	17~19
Tuner Operations .....	20~21
Timer Operations .....	22~23
Troubleshooting .....	25~26

