

Quick Start Guide



Step A *Connect*

Step B *Setup*

Step C *Enjoy*

What's in the Box?

You should find these items upon opening the box.

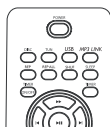

Remote Control

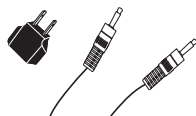

1 x MP3 link cable
1 x AC plug adaptor



Quick Start Guide

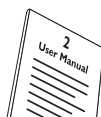

User Manual

PHILIPS

Step A *Connect*

1 Connect the speaker cables.

2 Connect the AC power cord to the wall socket.

Tip
See the User Manual on how to connect other equipment to this Micro Hi-Fi.

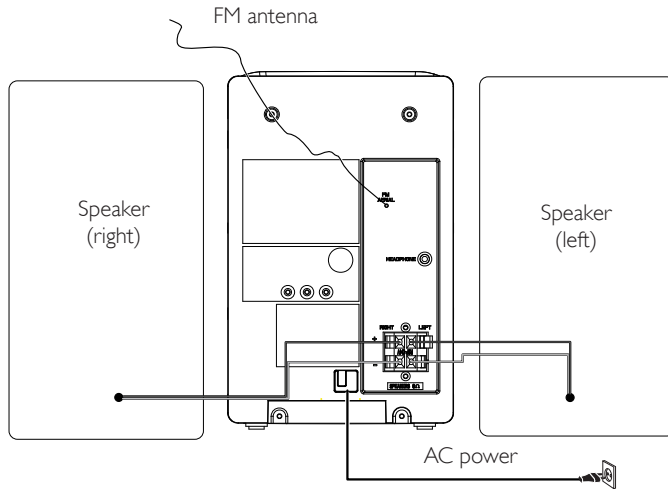

Step B *Setup*

Set clock

1 Press and hold **CLOCK** (or **CLOCK/DISPLAY** on the remote control) to activate the clock setting mode.
→ The 12 hour or 24 hour format is displayed.

2 Press **PROG** repeatedly to select 12 hour or 24 hour format.

3 Press **CLOCK** (or **CLOCK/DISPLAY** on the remote control) to confirm.
→ The hour digits are displayed and begin to blink.

4 Press **▶▶ / ◀◀** (or **◀◀ / ▶▶** on the remote control) to set the hour.

5 Press **CLOCK** (or **CLOCK/DISPLAY** on the remote control) to confirm.
→ The minute digits are displayed and begin to blink.

6 Press **▶▶ / ◀◀** (or **◀◀ / ▶▶** on the remote control) to set the minute.

7 Press **CLOCK** (or **CLOCK/DISPLAY** on the remote control) to confirm.

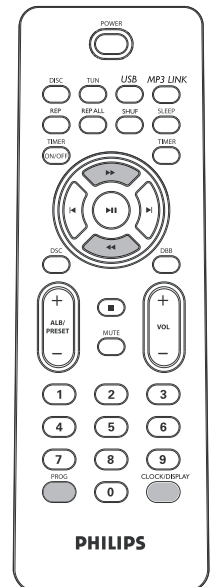

Step C Enjoy

Play disc

- 1 Press **SOURCE** (or **DISC** on the remote control) to select the disc source.
- 2 Lift the top panel to open the disc tray.
- 3 Insert a disc with the printed side facing up, then close the disc tray.
- 4 Press **▶||** to start play.
- 5 To stop play, press **■**.

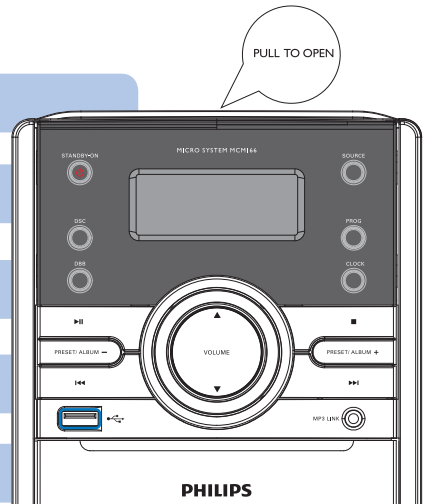

Play USB

With this Micro Hi-Fi, you can use USB flash memory (USB 2.0 or USB1.1), USB flash players (USB 2.0 or USB1.1), memory cards (requires an additional card reader to work with this Micro Hi-Fi).

- 1 Insert the USB device's USB plug into the socket  on the main unit.
- 2 Press **SOURCE** once or more (or **USB** on the remote control) to select USB.
- 3 Play the USB's audio files as you do with the albums/tracks on a CD.

Step C Enjoy

Listen to radio

- 1 Press **SOURCE** (or **TUN** on the remote control) repeatedly to select FM or AM.
- 2 Press **PROG** for more than two seconds to program all available stations in order of waveband.
- 3 Press **PRESET/ALBUM +/-** (or **ABL/PRESET +/-** on the remote control) to select a preset number.

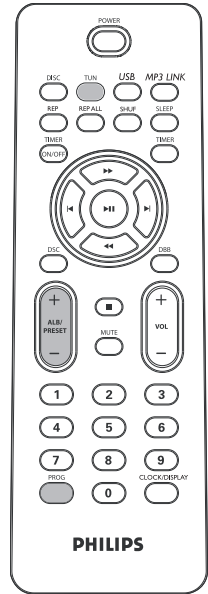

Tip

Detailed play features and additional functions are described in the supplied user manual.



© Royal Philips Electronics N.V. 2009
All rights reserved.

<http://www.philips.com>

