

MP3-CD Mini Hi-Fi System

FWM37

User manual

Manuel d'utilisation

Manual del usuario

使用説明



PHILIPS

México



Es necesario que lea cuidadosamente su instructivo de manejo.

	PRECAUCIÓN - ADVERTENCIA	
	No abrir, riesgo de choque eléctrico	
	ATENCIÓN	
	Verifique que el voltaje de alimentación sea el requerido para su aparato	
Para evitar el riesgo de choque eléctrico, no quite la tapa. En caso de requerir servicio, dirijase al personal calificado.		

Descripción: **Minisistema de Audio**
Modelo : **FWM37/ 21**
Alimentación: **110-127 / 220-240V~; 50-60 Hz**
Consumo: **35 W**
Importador: **Philips Mexicana, S.A. de C.V.**
Domicilio: **Av. La Palma No.6**
Col. San Fernando La Herradura
Huixquilucan
Localidad y Tel: **Edo. de México C.P. 52784**
Tel.52 69 90 00
Exportador: **Philips Electronics HK, Ltd.**
País de Origen: **China**
N° de Serie: _____

**LEA CUIDADOSAMENTE ESTE INSTRUCTIVO
ANTES DE USAR SU APARATO.**

AVISO IMPORTANTE

Philips Mexicana, S.A. de C.V. no se hace responsable por daños o desperfectos causados por:

- Maltrato, descuido o mal uso, presencia de insectos o roedores (cucarachas, ratones etc.).*
- Cuando el aparato no haya sido operado de acuerdo con el instructivo del uso, fuera de los valores nominales y tolerancias de las tensiones (voltaje), frecuencia (ciclaje) de alimentación eléctrica y las características que deben reunir las instalaciones auxiliares.*
- Por fenómenos naturales tales como: temblores, inundaciones, incendios, descargas eléctricas, rayos etc. o delitos causados por terceros (choques asaltos, riñas, etc.).*

CAUTION

Use of controls or adjustments or performance of procedures other than herein may result in hazardous radiation exposure or other unsafe operation.

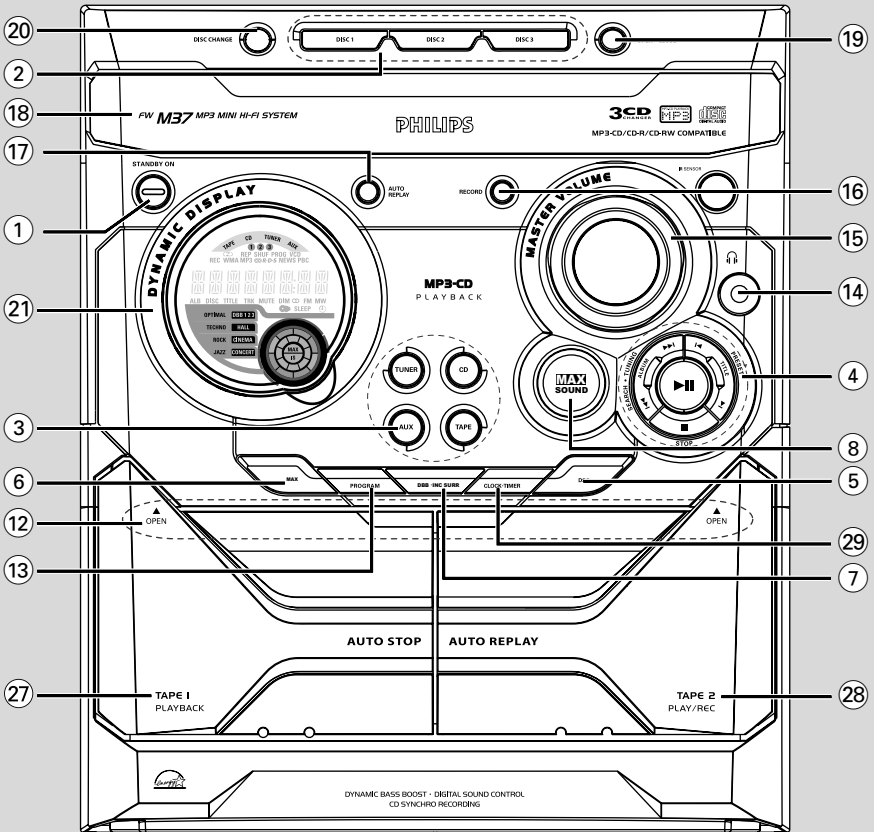
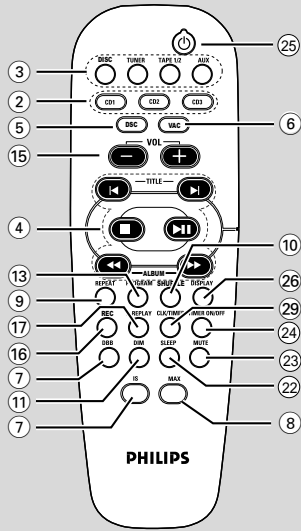

DEMO MODE

To turn ON

Press & HOLD



button

for 5 seconds

To turn OFF

Press & HOLD



button

for 5 seconds

PLUG & PLAY

(for tuner installation)

1



Plug in the unit

2



Follow instructions
in the display

3



Press "PLAY"

English ----- 6

Français ----- 28

Español ----- 51

中文 ----- 74

English

Français

Español

中文

Contents

General Information

Supplied accessories	7
Acknowledgement	7
Environmental information	7
Safety information	7

Preparations

Rear connections	8–9
Power	
Antennas connection	
Speakers connection	
Optional connection	9
Connecting other equipment to your system	
Inserting batteries into the remote control	9

Controls

Controls on the system and remote control	10–11
---	-------

Basic Functions

Plug and Play	12
Demonstration mode	13
Switching the system on	13
Switching the system to standby mode	13
Dim mode	13
Volume control	14
Sound control	14
MAX sound	
VAC (Virtual Ambience Control)	
DSC (Digital Sound Control)	
DBB (Dynamic Bass Boost)	
Incredible Surround	

CD/MP3-CD Operations

Discs for playback	15
About MP3 disc	15
Loading discs	15
Playing discs	16
Replacing discs during playback	16
Selecting a desired track/passage	16
Selecting a desired Album/Title (MP3 disc only)	16
Different play modes: SHUFFLE and REPEAT	17
Programming the disc tracks	17
Erasing the programme	17

Radio Reception

Tuning to radio stations	18
Storing preset radio stations	18–19
Automatic preset programming	
Manual preset programming	
Tuning to preset radio stations	19
Changing tuning grid	19

Tape Operation/Recording

Loading tape	20
Playing tapes	20
Rewinding/Fast forwarding	21
General information on recording	21
Preparation for recording	21
One touch recording	21
CD Synchronised start recording	22
Dubbing tapes	22

External Sources

Listening to external sources	22
-------------------------------------	----

Clock/Timer

View clock	23
Clock setting	23
Timer setting	24
To deactivate the TIMER	
To activate the TIMER	
Sleep timer setting	24

Specifications

.....	25
-------	----

Maintenance

.....	26
-------	----

Troubleshooting

.....	26–27
-------	-------

IMPORTANT!

PLEASE NOTE THAT THE VOLTAGE SELECTOR LOCATED AT THE REAR OF THIS SYSTEM IS PRESET AT 220V FROM THE FACTORY. FOR COUNTRIES THAT OPERATE AT 110V-127V, PLEASE ADJUST TO 110V-127V BEFORE YOU SWITCH ON THE SYSTEM.

Supplied accessories

- 2 speaker boxes
- remote control
- MW loop antenna
- FM wire antenna
- AC power cord

Environmental information

All unnecessary packaging has been omitted. We have tried to make the packaging easy to separate into three materials: cardboard (box), polystyrene foam (buffer) and polyethylene (bags, protective foam sheet).

Your system consists of materials which can be recycled and reused if disassembled by a specialised company. Please observe the local regulations regarding the disposal of packaging materials, exhausted batteries and old equipment.

Safety information

- Before operating the system, check that the operating voltage indicated on the typeplate (or the voltage indication beside the voltage selector) of your system is identical with the voltage of your local power supply. If not, please consult your dealer.
- Place the system on a flat, hard and stable surface.
- Place the system in a location with adequate ventilation to prevent internal heat build-up in your system. Allow at least 10 cm (4 inches) clearance from the rear and the top of the unit and 5 cm (2 inches) from each side.
- The ventilation should not be impeded by covering the ventilation openings with items, such as newspapers, table-cloths, curtains, etc.
- Do not expose the system, batteries or discs to excessive moisture, rain, sand or heat sources caused by heating equipment or direct sunlight.
- No naked flame sources, such as lighted candles, should be placed on the apparatus.
- No objects filled with liquids, such as vases, shall be placed on the apparatus.
- Don't expose the system to dripping or splashing.
- The lens may cloud over when the system is suddenly moved from cold to warm surroundings, making it impossible to play a disc. Leave the system in the warm environment until the moisture evaporates.
- The mechanical parts of the set contain self-lubricating bearings and must not be oiled or lubricated.
- **When the system is switched to Standby mode, it is still consuming some power. To disconnect the system from the power supply completely, remove the AC power plug from the wall socket.**

Preparations

English

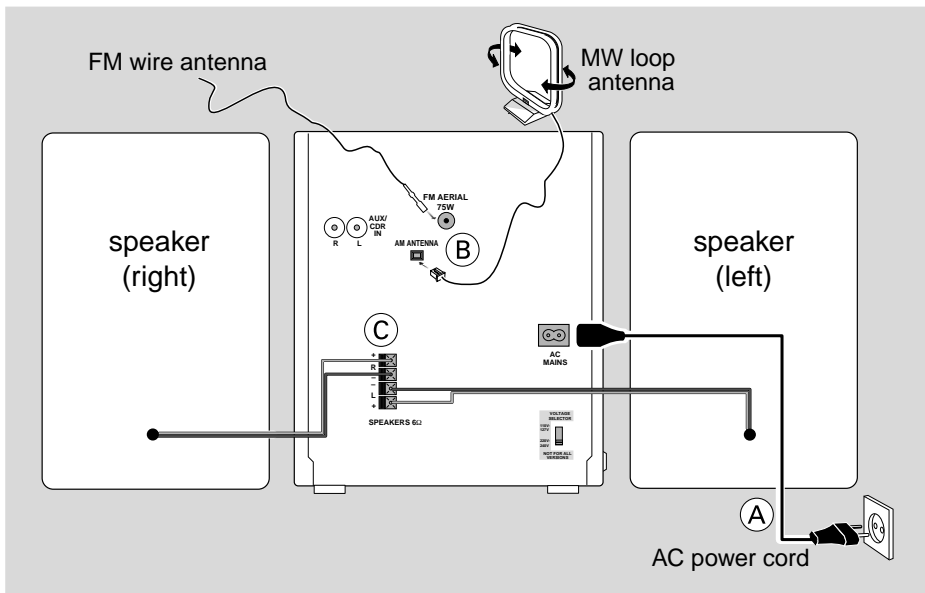

Rear connections

The type plate is located at the rear of the system.

(A) Power

- Before connecting the AC power cord to the wall outlet, ensure that all other connections have been made.
- If your system is equipped with a Voltage Selector, set the VOLTAGE SELECTOR to the local power line voltage.

WARNING!

- **For optimal performance, use only the original power cable.**
- **Never make or change any connections with the power switched on.**

To avoid overheating of the system, a safety circuit has been built in. Therefore, your system may switch to Standby mode automatically under extreme conditions. If this happens, let the system cool down before reusing it (not available for all versions).

(B) Antennas Connection

Connect the supplied MW loop antenna and FM antenna to the respective terminals. Adjust the position of the antenna for optimal reception.

MW Antenna

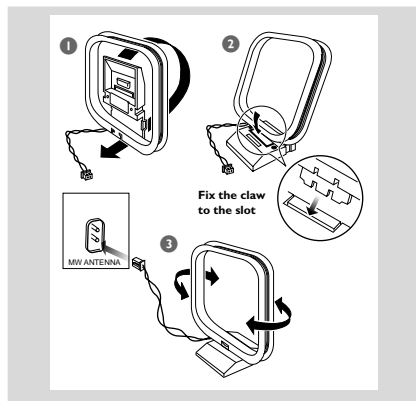

- Position the antenna as far as possible from a TV, VCR or other radiation source.

FM Antenna

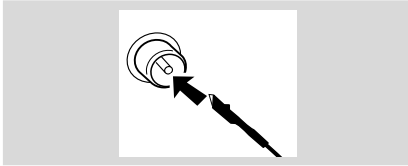

- For better FM stereo reception, connect an outdoor FM antenna to the FM ANTENNA terminal.

C Speakers Connection

Front Speakers

Connect the speaker wires to the SPEAKERS terminals, right speaker to "R" and left speaker to "L", coloured (marked) wire to "+" and black (unmarked) wire to "-".

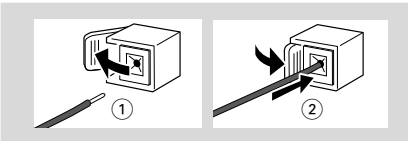

- Fully insert the stripped portion of the speaker wire into the terminal as shown.

Notes:

- For optimal sound performance, use the supplied speakers.
- Do not connect more than one speaker to any one pair of + / - speaker terminals.
- Do not connect speakers with an impedance lower than the speakers supplied. Please refer to the SPECIFICATIONS section of this manual.

Optional connection

The optional equipment and connecting cords are not supplied. Refer to the operating instructions of the connected equipment for details.

Connecting other equipment to your system

Use a cinch cable to connect **AUX/CDR** to the analogue audio out terminals of an external equipment (TV, VCR, Laser Disc player; DVD player or CD Recorder).

Note:

- If you are connecting equipment with a mono output (a single audio out terminal), connect it to the AUX/CDR left terminal. Alternatively, you can use a "single to double" cinch cable (the output sound still remain mono).

Inserting batteries into the remote control

Insert two batteries (Type R06 or AA) into the remote control with the correct polarity as indicated by the "+" and "-" symbols inside the battery compartment.

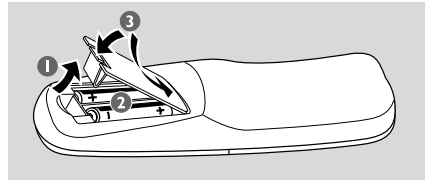

CAUTION!

- Remove batteries if they are exhausted or will not be used for a long time.
- Do not use old and new or different types of batteries in combination.
- Batteries contain chemical substances, so they should be disposed off properly.

Controls on the system and remote control

① STANDBY ON

- to switch the system on or to standby mode.

② DISC 1/2/3 (CD DIRECT 1/2/3)

- to select a disc tray for playback.

③ Source selection – to select the following :

CD (CD 1•2•3)

- to select disc tray 1, 2 or 3.

TUNER (BAND)

- to select waveband : FM or MW.

TAPE (TAPE 1•2)

- to select tape deck 1 or 2.

AUX (VIDEO/CDR)

- to select the input for an additional appliance : AUX or CDR.

④ Mode Selection

◀▶ SEARCH•TUNING

for MP3-CD to select previous/next album.

for CD to search backward/forward.

for Tuner to tune to a lower or higher radio frequency.

for Tape to rewind or fast forward.

for Clock (on the system only) to set the hour.

■ STOP

for CD/ MP3-CD .. to stop playback or to clear a programme.

for Tuner (on the system only) to stop programming.

for Tape to stop playback or recording.

for Demo (on the system only) to activate/deactivate the demonstration.

for Clock (on the system only) to exit clock setting.

for Plug & Play (on the system only) to exit plug & play mode.

▶ II PLAY•PAUSE

for CD/ MP3-CD .. to start or interrupt playback.

for Tape to start playback.

for Plug & Play (on the system only) to initiate and start plug & play mode.

◀ PREV / ▶ NEXT (– TITLE +)

for MP3-CD to select previous/next title.

for CD to skip to the beginning of the current, previous, or next track.

for Tuner to select a preset radio station.

for Clock (on the system only) to set the minute.

⑤ DSC

- Selects different type of preset sound equaliser settings. (OPTIMAL, JAZZ, ROCK or TECHNO)

⑥ VAC

- Selects different type of ambience-based equaliser settings. (HALL, CONCERT or CINEMA)

⑦ DBB/INC. SURR (DBB, IS)

- to select the desired bass boost level. (DBB 1, DBB 2, DBB 3 or DBB OFF)
- to activate or deactivate the surround sound effect.

⑧ MAX SOUND



- to activate or deactivate the optimal mix of various sound features.

⑨ REPEAT

- to playback track(s)/disc(s)/programme repeatedly.

⑩ SHUFFLE

- Turns on/off the random play mode.

- ⑪ **DIM MODE**
 - to select different brightness for the display screen : DIM 1, DIM 2, DIM 3 or DIM OFF.
- ⑫ **▲ OPEN**
 - to open the tape deck door.
- ⑬ **PROGRAM**
 - for CD/ MP3-CD ..to programme disc tracks.
 - for Tunerto programme preset radio stations.
 - for Clockto select 12- or 24-hour clock mode.
- ⑭ 
 - to connect headphones.
- ⑮ **VOLUME (VOL +/-)**
 - to increase or decrease the volume.
- ⑯ **RECORD**
 - to start recording on tape deck 2.
- ⑰ **AUTO REPLAY**
 - to select continuous playback in either AUTO REPLAY or ONCE MODE only.
- ⑱ **Disc tray**
- ⑲ **OPEN•CLOSE**
 - to open or close the disc tray.
- ⑳ **DISC CHANGE**
 - to change disc(s).
- ㉑ **Display screen**
 - to view the current status of the system.
- ㉒ **SLEEP**
 - to activate/deactivate or set the sleep timer.
- ㉓ **MUTE**
 - Mutes or restores the volume.
- ㉔ **TIMER ON/OFF**
 - activates/deactivates the timer function.
- ㉕ 
 - to switch the system to standby mode.
- ㉖ **DISPLAY**
 - Display the album and title name for MP3 disc.
- ㉗ **Tape deck 1**
- ㉘ **Tape deck 2**
- ㉙ **CLOCK•TIMER (CLK/TIMER)**
 - to view the clock.

Notes for remote control:

- First, select the source you wish to control by pressing one of the source select keys on the remote control (CD or TUNER, for example).
- Then select the desired function (▶, ◀, ▶/◀, for example).

Basic Functions

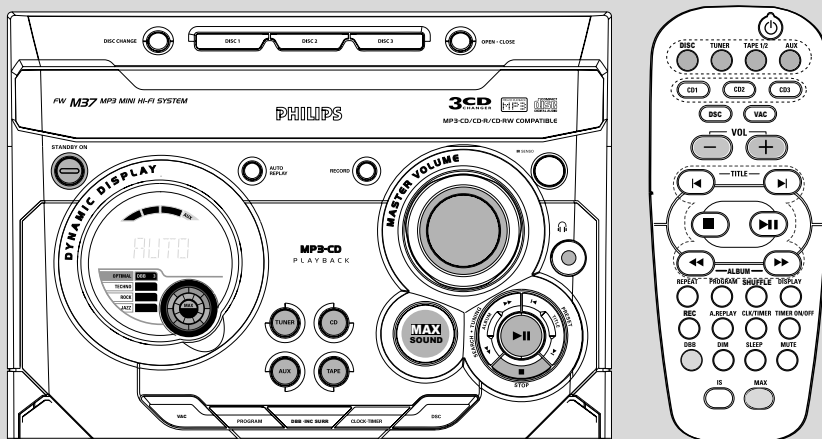

IMPORTANT!

Before you operate the system, complete the preparation procedures.

Plug and Play (for tuner installation)

Plug and Play allows you to store all available radio stations automatically.

First time setup/power up

- 1 When you turn on the main supply, "AUTO INSTALL - PRESS PLAY" is displayed.
- 2 Press **▶||** on the system to start installation.
→ "PLUG AND PLAY" "INSTALL" is displayed, followed by "TUNER" and "AUTO".
→ **PROG** starts flashing.
→ All available radio stations with sufficient signal strength will be stored automatically, starting from FM and followed by MW band.
→ When all the available radio stations are stored or the memory for 40 presets are used, the last preset radio station will be played.

To reinstall Plug and Play

- 1 In standby or demonstration mode, press and hold **▶||** on the system until "AUTO INSTALL - PRESS PLAY" is displayed.
- 2 Press **▶||** again to start installation.
→ All previously stored radio stations will be replaced.

To exit without storing the Plug and Play

- Press **■** on the system.
→ If you do not complete the Plug and Play installation, the function will be restarted when you next turn on the main supply again.

Notes:

- When the power is turned on, the disc tray may open and close to initialise the system.
- If no stereo frequency is detected during Plug and Play, "CHECK ANTENNA" will be displayed.
- During Plug and Play, if no button is pressed within 15 seconds, the system will exit Plug and Play mode.

Demonstration mode

The system has a demonstration mode that shows the various features offered by the system.

To activate the demonstration

- In **standby mode**, press and hold **■** on the system for 5 seconds to switch to demonstration.

To deactivate the demonstration

- Press and hold **■** on the system for 5 seconds to switch to standby mode.

Switching the system on

In standby/demonstration mode

- Press **STANDBY ON** (⏻) to switch on the last selected source.
- Press **CD, TUNER, TAPE (TAPE 1/2)** or **AUX**.
- Press **OPEN•CLOSE, DISC 1/2/3 (CD 1/2/3), DISC CHANGE**.
→ The system will switch to CD mode.

Switching the system to standby mode

In demonstration mode

- Press and hold **■** on the system.

In any other source mode

- Press **STANDBY ON** (or ⏻ on the remote control).
→ The clock will appear on the display when the system is in standby mode.

Dim mode

You can select the desired brightness for the display.

- In any source mode, press **DIM MODE** repeatedly to select DIM 1, DIM 2, DIM 3 or DIM OFF display mode.
→ **DIM** is shown, except for DIM OFF mode.

DIM mode	Brightness	Spectrum Analyser
1	normal	off
2	half	on
3	half	off
OFF	normal	on

Volume control

Adjust **VOLUME** to increase (turn knob clockwise or press **VOLUME +**) or decrease (turn knob anti-clockwise or press **VOLUME -**) the sound level.

To listen through the headphones

- Connect the headphones plug to the  socket at the front of the system.
→ The speakers will be muted.



To switch off the volume temporarily

- Press **MUTE** on the remote control.
→ Playback will continue without sound and "MUTE" is displayed.
- To restore the volume, press **MUTE** again or increase the volume level.

Basic Functions

Sound control

For optimal sound listening, select only one of the following navigation sound controls at a time : **MAX**, **DSC** or **VAC**.

MAX Sound

MAX sound provides the best mixture of various sound features (DSC, VAC, DBB, for example).

- Press **MAX** (or **MAX** on the remote control) repeatedly.
 - If activated, **MAX SOUND** is shown and the MAX SOUND button lights up.
 - If deactivated, "MAX OFF" is displayed and the MAX button black out.

Note:

– When MAX sound is selected, all other sound navigation will switch off automatically.

VAC (Virtual Ambience Control)

The VAC feature enables you to adjust the system to select a type of environment.

- Press **VAC** to select : CINEMA, HALL or CONCERT.
 - The selected VAC is shown.

Note:

– When you select VAC, Incredible Surround will switch on automatically.

DSC (Digital Sound Control)

The DSC feature enables you to enjoy special sound effects that have preset equaliser settings, providing the best music reproduction.

- ① Press **DSC** to select : OPTIMAL, JAZZ, ROCK or TECHNO.
 - The selected DSC is shown.

DBB (Dynamic Bass Boost)

There are three DBB settings to enhance the bass response.

- ① Press **DBB** to select : DBB 1, DBB 2, DBB 3 or DBB OFF.
 - The selected **DBB** is shown, except for DBB OFF mode.

Note:

– Some discs or tapes might be recorded in high modulation, which causes a distortion at high volume. If this occurs, switch off DBB or reduce the volume.

Automatic DSC-DBB selection

The best DBB setting is generated automatically for each DSC selection. You can manually select the DBB setting that best suits your listening environment.

DSC	DBB
JAZZ	off
ROCK	on (3)
TECHNO	on (3)
OPTIMAL	on (2)

Incredible Surround

The Incredible Surround magnifies the virtual distance between the front speakers for an incredibly wide, enveloping, stereo effect.

- Press and hold **DBB•INC SURR** (or **IS** on the remote control) until "INCR SUR" is display.
 - If activated, **INCR SUR** is shown and "INCR SUR" is displayed.
 - If deactivated, "IS OFF" is displayed.

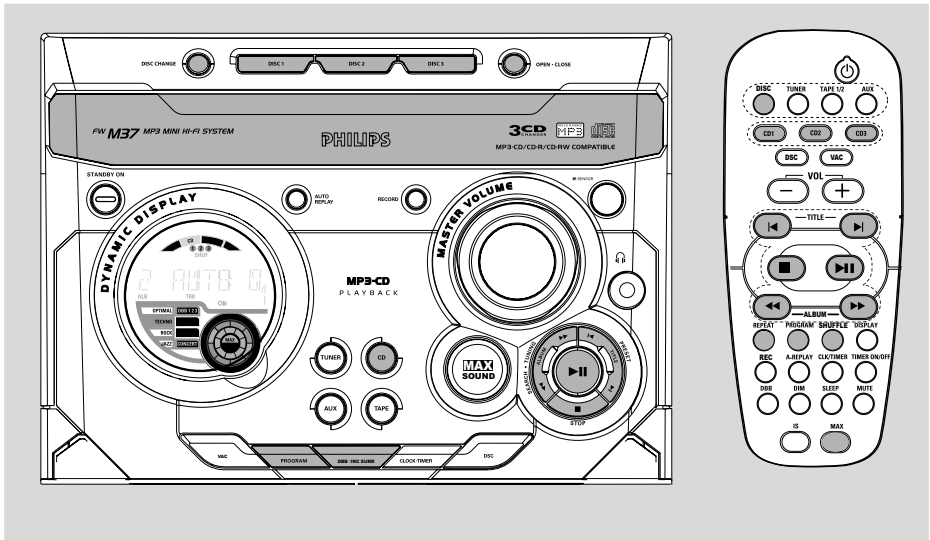

IMPORTANT!

- This system is designed for regular discs. Therefore, do not use any accessories such as disc stabiliser rings or disc treatment sheets, etc., as offered on the market, because they may jam the changer mechanism.
- Do not load more than one disc into each tray.

Discs for playback

This system can playback all digital audio CD, finalised digital audio CD-Recordable (CDR) discs and finalised digital audio CD-Rewritable (CDRW) discs.
MP3-CDs (CD-ROMs with MP3 tracks)



About MP3 disc

Supported formats

- ISO9660, Joliet, Multisession
- Max. track number plus album is 255
- Max. nested directory is 8 levels
- The max. album number is 32
- The max. MP3 program track number is 99
- Supported VBR bit-rate
- Supported sampling frequencies for MP3 disc are: 32 kHz, 44.1 kHz, 48 kHz
- Supported Bit-rates of MP3 disc are: 32, 64, 96, 128, 192, 256 (kbps)

Loading discs

- 1 Press **OPEN-CLOSE** to open the disc tray.
- 2 Load up to two discs on the individual disc trays. To load the third disc, press **DISC CHANGE**.
→ The disc tray will rotate until the empty tray is ready for loading.

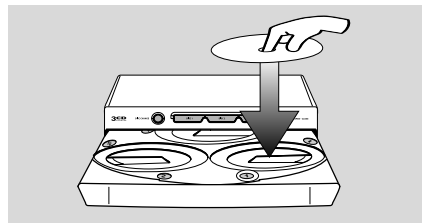

CD/MP3-CD Operations

- Press **OPEN•CLOSE** to close the disc tray.
→ "READING" is displayed. The selected disc tray, total number of tracks and the playing time will appear on the display.
→ A lighted button indicates that a disc is loaded on the disc tray.
→ For **MP3 disc**, the name of the first album and title will be scrolled through the display once and followed by "XXXX XXXX".

Notes:

- Load the discs with the label side facing up.
- To ensure good system performance, wait until the disc tray completely reads the disc(s) before proceeding.
- For **MP3 disc**, the disc reading time may exceed 10 seconds due to the large number of songs compiled into one disc.

Playing discs

To play current disc on the disc tray

- Press **▶||**.
→ The current discs will play once, then stop.
→ During playback, the selected disc tray, track number and elapsed playing time of the current track are displayed.
→ For **MP3 disc**, **TITLE** is shown. For mixed mode discs, only one mode will be selected for playback depending on the recording format.

To play the selected disc only

- In CD mode, press **DISC 1/2/3** (or **CD 1/2/3** on the remote control).
→ The selected disc will play once, then stop.

To interrupt playback

- Press **▶||**.
→ The current track time flashes.
- To resume playback, press **▶||** again.

To stop playback

- Press **■**.

For MP3-CD

- During playback, press **DISPLAY** to show the album and title name.

Replacing discs during playback

- Press **DISC CHANGE**.
→ The disc tray will open without interrupting current playback.
- To change the inner disc, press **DISC CHANGE** again.
→ "CHANGING DISC" is displayed and the disc will stop playing.
→ The disc tray will close to retrieve the inner disc, then reopen with the inner disc accessible.

Selecting a desired track/passage

To search for a particular passage during playback

- Press and hold **◀◀** or **▶▶** and release it when the desired passage is located.
→ During searching, the volume will be reduced.

To select a desired track

- Press **◀** or **▶** repeatedly until the desired track is displayed.
- If playback is stopped, press **▶||** to start playback.

Selecting a desired Album/Title (MP3 disc only)

To select a desired album

- Press **ALBUM -/+** (**◀◀** or **▶▶**) repeatedly.
→ The album's name will scroll through the display once.

To select a desired title

- Press **TITLE -/+** (**◀** / **▶**) repeatedly.
→ The title's name will scroll through the display once.

Note:

- The album and title will only displayed once when selected. To view again, press the **DISPLAY** button repeatedly to display **ALBUM** and **TITLE** alternatively.

Different play modes: SHUFFLE and REPEAT

You can select and change the various play modes before or during playback.

- 1 Press **REPEAT** on the remote control to select:
 - "REPEAT TRACK" – to repeat playback of the current track.
 - "REPEAT DISC" – to repeat playback of the current disc.
 - "REPEAT OFF" – to stop repeat function and playback current disc.
- To resume normal playback, press **REPEAT** until "REPEAT OFF" is displayed.
- 2 Press **SHUFFLE** on the remote control to select:
 - "SHUFFLE ON" – to random playback of the current disc.
 - "SHUFFLE OFF" – to stop shuffle function and playback current disc.
- To resume normal playback, press **SHUFFLE** until "SHUFFLE OFF" is displayed.
 - **REP** or **SHUF** is shown, except SHUFFLE OFF mode.

Note:

– During program play mode or playing a MP3 CD, it is not possible to repeat playback the current disc (Repeat Disc mode).

Programming the disc tracks

Programming tracks is possible when playback is stopped. Up to 99 tracks can be stored in the memory in any order.

- 1 Load the desired discs on the disc tray (refer to "Loading discs").
- 2 Press **DISC 1/2/3** to select a disc.
- 3 Press **PROG** to start programming.
 - **PROG** starts flashing.
- 4 Press **◀** or **▶** repeatedly to select the desired track.

- For MP3 disc, press **ALBUM** **-/+** and **TITLE** **-/+** to select the desired album and title for programming.
- 5 Press **PROG** to store the track.
- 6 To end programming, press **■** **once**.
 - **PROG** stays and the programme mode remains active.
 - The total number of tracks programmed and the total playing time are displayed.
 - For MP3 disc, total playing time will not be shown.
- 7 To start programme play, press **▶||**.
 - "PLAY PROGRAM" is displayed.

Notes:

- It is not possible to create a programme with MP3 tracks from multiple CDs, or combined with normal audio tracks.
- If the total playing time is more than "99:59" then "- : - : -" is displayed instead of the total playing time.
- If you attempt to programme more than 99 tracks, "FULL" is displayed.
- During programming, if no button is pressed within 20 seconds, the system will exit the programme mode automatically.

To review the programme

- Stop playback and press **◀** or **▶** repeatedly.
- To exit review mode, press **■**.

Erasing the programme

- Press **■** **once** when playback is stopped or **twice** during playback.
 - **PROG** disappears and "PROGRAM CLEAR" is displayed.

Note:

- The programme will be erased when the system is disconnected from the power supply or when the disc tray is opened.

For Recording, please refer to "Tape Operation/Recording".

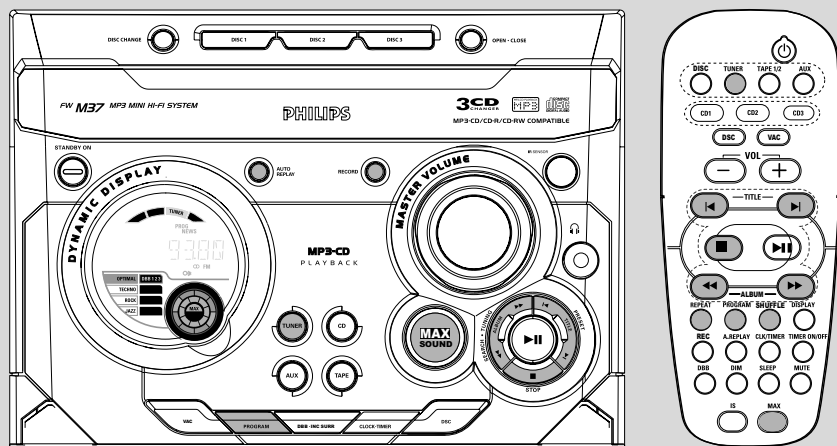

Tuning to radio stations

- 1 Press **TUNER** to select TUNER mode.
→ "TUNER" is displayed. A few seconds later; the current radio frequency will appear on the display.
- 2 Press **TUNER** again to select the desired waveband : FM or MW.
- 3 Press and hold **◀◀** or **▶▶** until the frequency indication starts to change, then release.
→ The display will show "SEARCH" until a radio station with sufficient signal strength is found.
- 4 Repeat step 3 if necessary until you find the desired radio station.
- To tune to a weak station, press **◀◀** or **▶▶** briefly and repeatedly until optimal reception found.

Storing preset radio stations

You can store up to 40 preset radio stations in the memory.

Automatic Preset Programming

- Plug and Play setting (refer to "Basic Functions - Plug and Play").
- OR
- 1 Press **TUNER** to select TUNER mode.

To begin automatic preset from a desired preset number

- Press **◀** or **▶** to select the desired preset number.
→ If a radio station has been stored in one of the presets, it will not be stored again under another preset number.
- 2 Press and hold **PROGRAM** until "AUTO" is displayed.
→ **PROG** starts flashing.
→ All available radio stations with sufficient signal strength will be stored automatically, starting from FM and followed by MW band.
→ When all the available radio stations are stored or the memory for 40 presets are used, the last preset radio station will be played.

To stop storing the automatic preset

- Press **PROGRAM** or **■** on the system.

Note:

– If no preset number is selected, automatic preset will begin from preset (1) and all your former presets will be overridden.

Manual Preset Programming

- 1 Tune to your desired radio station (refer to "Tuning to radio stations").
- 2 Press **PROGRAM**.
→ **PROG** starts flashing.
→ The next available preset number is displayed for selection.

To store the radio station to another preset number

- Press **◀** or **▶** to select the desired preset number.
- 3 Press **PROGRAM** again to store the radio station.
→ **PROG** disappears.
- Repeat **steps 1–3** to store other radio stations.

To exit manual preset mode

- Press **■** on the system.

Notes:

- If you attempt to store more than 40 preset radio stations, "FULL" is displayed.
- During programming, if no key is pressed within 20 seconds, the system will exit the programme mode automatically.

Tuning to preset radio stations

- Once you've programmed the radio stations, press **◀** or **▶** to select the desired preset number.
→ The preset number, radio frequency, and waveband are displayed.

For Recording, please refer to "Tape Operation/Recording".

Changing tuning grid *(not available for all versions)*

In North and South America, the frequency step between adjacent channels in the MW band is 10 kHz (9 kHz in some areas). The preset frequency step in the factory is 9 kHz.

Changing the tuning grid will erase all previously stored preset radio stations.

- 1 Disconnect the system from the AC power supply (pull out the AC power cord).
- 2 While holding down **TUNER** and **▶▶** on the system, reconnect the system to the AC power supply.
→ The display will show "GRID 9" or "GRID 10".

Notes:

- GRID 9 and GRID 10 indicate that the tuning grid is in step of 9 kHz and 10 kHz respectively.
- The FM tuning grid also will be changed from 50 kHz to 100 kHz or vice versa.

Tape Operation/Recording

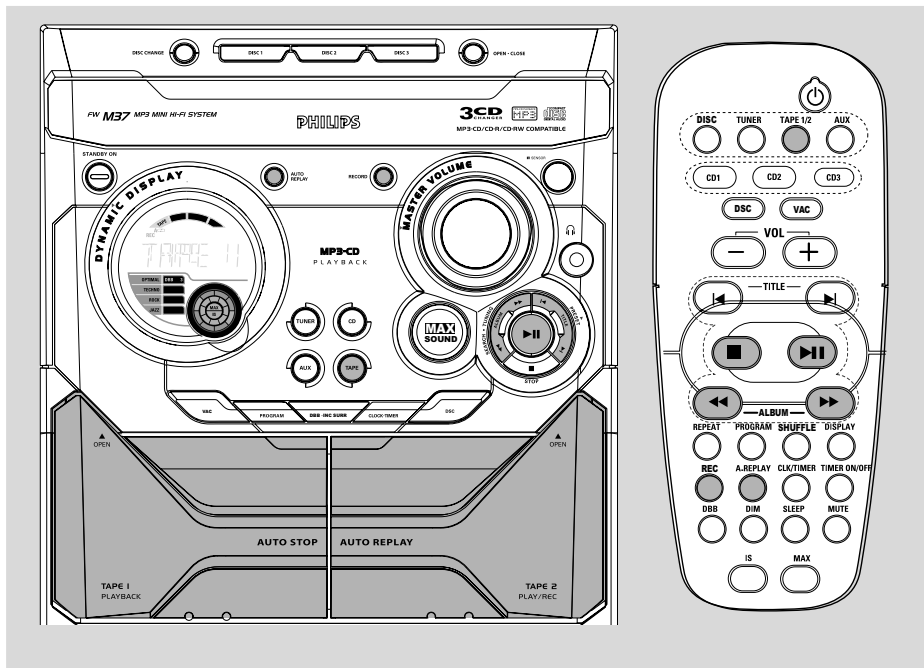

IMPORTANT!

- Before playing a tape, check and tighten slack tape with a pencil. Slack tape may get jammed or may burst in the mechanism.
- C-120 tape is extremely thin and is easily deformed or damaged. It is not recommended for use in this system.
- Store the tapes at room temperature and do not put them too close to a magnetic field (for example, a transformer, TV or speaker).

Loading tape

- 1 Press **OPEN** to open the tape deck door.

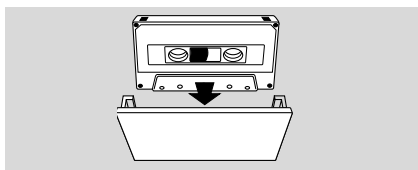

- 2 Load the tape with the open side downward and full spool to the left.
- 3 Close the tape deck door.

Playing tapes

To playback a selected tape deck

- 1 Press **TAPE** (or **TAPE 1/2** on the remote control) repeatedly to select tape deck 1 or 2.
- 2 Press **▶||**.

To stop playback

- Press **■**.

To select automatic replay or one time playback

- Press **AUTO REPLAY** (or **A.REPLAY**) repeatedly to select the different playback modes.
 → "AUTO REPLAY" () or "ONCE" () is displayed.

AUTO REPLAY ...the tape will rewind automatically at the end of playback and replay again. It will replay up to a maximum of 20 times.

ONCEthe tape will playback the selected side once and then stop.

Rewinding / Fast forwarding

- 1 Stop playback, press ◀◀ or ▶▶.
→ The tape will stop automatically at the end of rewinding or fast forwarding.
- 2 Press ■ to stop rewinding or fast forwarding.

Note:

– During rewinding or fast forwarding of a tape, it is also possible to select another source (CD or TUNER, for example).

General information on recording

- For recording, use only tape of IEC type I (normal tape).
- The recording level is set automatically, regardless of the position of the Volume, DBB, DSC and so forth.
- The tape is secured at both ends with leader tape. At the beginning and end of the tape, nothing will be recorded for six to seven seconds.
- To prevent accidental recording, break out the tab on the left shoulder of the tape side you want to protect.
- If "CHECK TAPE" is displayed, the protection tab has been broken. Put a piece of clear adhesive tape over the opening.

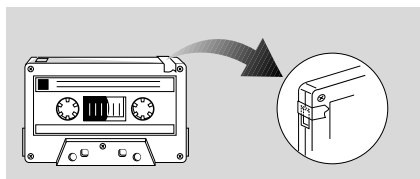
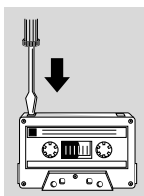

IMPORTANT!

- Recording is permissible if copyright or other rights of third parties are not infringed upon.
- Recording is possible only on tape deck 2.

Preparation for recording

- 1 Press **TAPE** to select TAPE 2.
- 2 Load a recordable tape into tape deck 2 with full spool to the left.
- 3 Prepare the source to be recorded.
CD – load the disc(s).
TUNER – tune to the desired radio station.
TAPE – load the prerecorded tape into tape deck 1 with the full spool to the left.
AUX – connect external equipment.

When recording is in progress

- **REC** starts flashing.
- It is not possible to listen to another source, except tape dubbing.
- It is not possible to activate the timer function during recording or tape dubbing.

One touch recording

- 1 Press **CD**, **TUNER** or **AUX** to select the source.
- 2 Start playback of the selected source.
- 3 Press **RECORD** to start recording.

To stop recording

- Press ■ on the system.

Note:

– One Touch Recording is not possible in TAPE mode, "SELECT SOURCE" is displayed.

Tape Operation/Recording

CD Synchronised start recording

- 1 Press **CD** to select the disc.
- Press **◀** or **▶** to select the desired track, then press **RECORD** to start recording.
- You can programme the tracks in the order you want them to be recorded (refer to "CD Operation - Programming the disc tracks").
- 2 Press **RECORD** to start recording.
→ The disc will start playback automatically.

To stop recording

- Press **■**.
→ Recording and disc playback will stop simultaneously.

Dubbing tapes

- 1 Load the prerecorded tape in tape deck 1.
- You can set the tape to the desired passage where recording will start.
- 2 Press **RECORD**.
→ Playing and recording will start simultaneously.
→ "DBB" is displayed.
- Dubbing of tapes is possible on one side of the tape only. To continue recording on the reverse side, at the end of side A, flip the tape to side B and repeat the procedure.

To stop dubbing

- Press **■**.

Notes:

- Dubbing of tapes is possible only from tape deck 1 to tape deck 2.
- To ensure good dubbing, use tapes of the same length.

External Sources

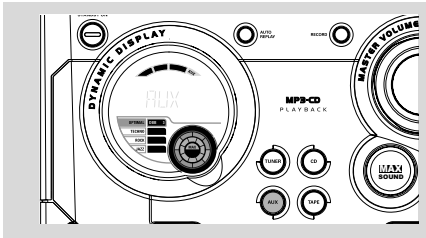

Note:

- All the sound control features (DSC or DBB, for example) are available for selection.
- Refer to the operating instructions for the connected equipment for details.

For Recording, please refer to "Tape Operation/Recording".

Listening to external sources

- 1 Connect the audio out terminals of the external equipment (TV, VCR, Laser Disc player, DVD player or CD Recorder) to the **AUX/CDR** terminals of your system.
- 2 Press **AUX** to select external equipment.
→ "FLUX" or "CDR" is displayed.

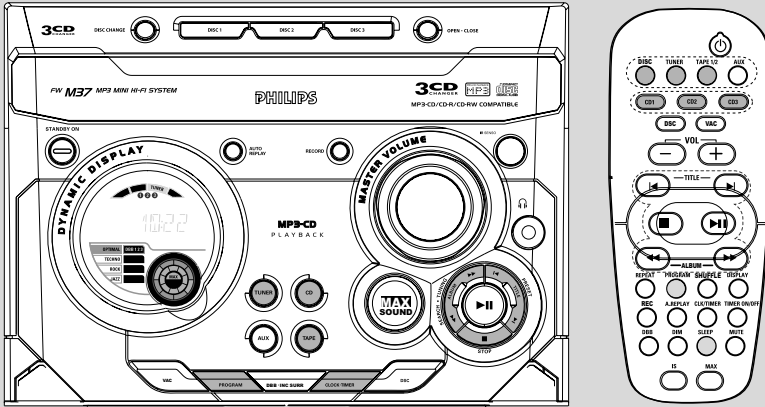

IMPORTANT!

- Use **CLOCK•TIMER** on the set to set the clock and timer.
- Use **CLOCK•TIMER (CLK•TIMER)** to set the clock and timer.

View clock

The clock (if it is set) will be shown in standby mode.

To view the clock in any source mode (CD or TUNER for example)

- Press **CLOCK•TIMER**.
 - The clock is displayed for a few seconds.
 - If the clock has not been set, "----:--" is displayed.

Clock setting

The clock can be set in either 12-hour or 24-hour mode ("PM 12:00" or "00:00" for example)

- 1 In standby or view clock mode, press **CLOCK•TIMER once**. In other source mode, press **CLOCK•TIMER twice**.
- 2 Press **PROGRAM** repeatedly to select clock mode.
 - "PM 12:00" or "00:00" starts flashing.
- 3 Press **◀** or **▶** on the system repeatedly to set the hour.

- 4 Press **◀** or **▶** on the system repeatedly to set the minute.
- 5 Press **CLOCK•TIMER** again to store the setting.
 - The clock starts working.

To exit without storing the setting

- Press **■** on the system.

Notes:

- The clock setting will be cancelled when the power cord is disconnected or if a power failure occurs.
- During clock setting, if no button is pressed within 90 seconds, the system will exit clock setting mode automatically.

Timer setting

The system can switch on to CD, TUNER, or TAPE 2 mode automatically at a preset time, serving as an alarm to wake you up.

IMPORTANT!

- Before setting the timer, ensure that the clock is set correctly.
- The timer will always be switched on after it has been set.
- The timer will not start if a recording is in progress.
- The volume of the timer will increase gradually from the minimum level to the last tuned volume level.

- 1 Press and hold **CLOCK•TIMER** for more than **two seconds** to select timer mode.
 - The last timer setting starts flashing.
 - **TIMER** starts flashing.
 - The selected source will be lighted and flashing.
- 2 Press **CD, TUNER** or **TAPE** to select the desired source.
 - Before setting timer; make sure the music source has been prepared.
 - CD** – Load the disc(s). To start from a specific track, make a programme (refer to “CD Operation - Programming the disc tracks”).
 - TUNER** – tune to the desired radio station.
 - TAPE** – load the prerecorded tape into tape deck 2.
- 3 Press **◀** or **▶** on the system repeatedly to set the hour for the timer to start.
- 4 Press **◀** or **▶** on the system repeatedly to set the minute for the timer to start.
- 5 Press **CLOCK•TIMER** to store the start time.
 - **TIMER** remains on the display.
- At the preset time, the selected source will play.

To exit without storing the setting

- Press **■** on the system.

Notes:

- When the preset time is reached and the selected disc tray is empty, the next available disc will be selected. If all the disc trays are not available, Tuner will be selected automatically.
- During timer setting, if no button is pressed within 90 seconds, the system will exit timer setting mode automatically.

To deactivate the TIMER

- Press **TIMER ON/OFF** on the remote control.
 - The display will show “OFF” and **TIMER** will disappear from the display.

To activate the TIMER

- Press **TIMER ON/OFF** on the remote control.
 - The last set timer information will be shown for a few seconds and **TIMER** will appear on the display.

Sleep timer setting

The sleep timer enables the system to switch to standby mode automatically at a preset time.

- 1 Press **SLEEP** on the remote control repeatedly to select a preset time.
 - The selections are as follows (time in minutes):
15 → 30 → 45 → 60 → OFF → 15 ...
 - “SLEEP :xx” or “OFF” is displayed. “xx” is the time in minutes.
- 2 When you reach the desired length of time, stop pressing the **SLEEP** button.
 - **SLEEP** is shown, except for “OFF” mode.
 - The sleep timer is now set. Before the system switches to standby mode, a countdown of 10 seconds is displayed.
“SLEEP 10” → “SLEEP 9”... → “SLEEP 1”
→ “SLEEP”

To check the remaining length of time after sleep timer is activated

- Press **SLEEP** once.

To change the preset sleep timer

- Press **SLEEP** again while the remaining sleep timer is shown.
 - The display will show the next sleep timer options.

To deactivate the sleep timer

- Press **SLEEP** repeatedly until “OFF” is displayed, or press the **STANDBY ON** button.

AMPLIFIER

Output power	2000 W PMPO
.....	2 × 60 W RMS ⁽¹⁾
Signal-to-noise ratio	≥ 67 dBA (IEC)
Frequency response	50 – 15000 Hz
Input sensitivity	
AUX/CDR In	500 mV / 1V
Output	
Speakers	≥ 6 Ω
Headphones	32 Ω – 1000 Ω
(1) (6 Ω, 1 kHz, 10% THD)	

CD/MP3-CD PLAYER

Number of programmable tracks	99
Frequency response	20 – 20000 Hz -3dB
Signal-to-noise ratio	≥ 75 dBA
Channel separation	≥ 60 dB (1 kHz)
Total harmonic distortion.....	< 0.003%
MPEG 1 Layer 3 (MP3-CD)	MPEG AUDIO
MP3-CD bit rate	32-256 kbps
	(128 kbps advised)
Sampling frequencies	32, 44.1, 48 kHz

TUNER

FM wave range	87.5 – 108 MHz
MW wave range (9 kHz)	531 – 1602 kHz
MW wave range (10 kHz)	530 – 1700 kHz
Tuning grid	9/10 kHz
Number of presets	40
Antenna	
FM	75 Ω wire
MW	Loop antenna

TAPE PLAYER

Frequency response	
Normal tape (type I)	80 – 12500 Hz (8 dB)
Signal-to-noise ratio	
Normal tape (type I)	≥ 48 dBA
Wow and flutter	≤ 0.4% DIN

SPEAKERS

System 3-way; double port bass reflex	
Impedance	6 Ω
Woofer	1 × 5.5"
Tweeter	1 × 2"
Dimensions (w × h × d)	248 × 310 × 195 (mm)
Weight	3.3 kg each

GENERAL

Material/finish	Polystyrene/Metal
AC Power	
For Version /21-21M ..	110 – 127 / 220 – 240 V;
.....	50/60 Hz Switchable
For Version /30	230 – 240 V; 50 Hz
Power Consumption	
Active	35 W
Standby	≤ 15 W
Dimensions (w × h × d) ..	265 × 310 × 367 (mm)
Weight (without speakers)	7.15 kg

Specifications and external appearance are subject to change without notice.

Maintenance

Cleaning the Cabinet

- Use a soft cloth slightly moistened with a mild detergent solution. Do not use a solution containing alcohol, spirits, ammonia or abrasives.

Cleaning Discs

- When a disc becomes dirty, clean it with a cleaning cloth. Wipe the disc from the centre out. Do not wipe in circular motion.
- Do not use solvents such as benzene, thinner, commercially available cleaners, or antistatic spray intended for analogue records.



Cleaning the disc lens

- After prolonged use, dirt or dust may accumulate at the disc lens. To ensure good playback quality, clean the disc lens with Philips CD Lens Cleaner or any commercially available cleaner. Follow the instructions supplied with cleaner.

Cleaning the Heads and the Tape Paths

- To ensure good recording and playback quality, clean the heads (A), the capstan(s) (B), and pressure roller(s) (C) after every 50 hours of tape operation.
- Use a cotton swab slightly moistened with cleaning fluid or alcohol.
- You also can clean the heads by playing a cleaning tape once.

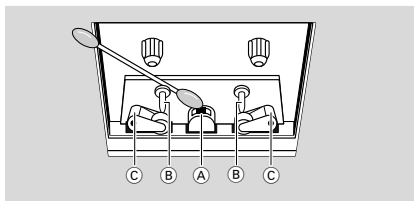

Demagnetising the heads

- Use a demagnetising tape available at your dealer.

Troubleshooting

WARNING

Under no circumstances should you try to repair the system yourself, as this will invalidate the warranty. Do not open the system as there is a risk of electric shock.

If a fault occurs, first check the points listed below before taking the system for repair. If you are unable to remedy a problem by following these hints, consult your dealer or Philips for help.

Problem	Solution
"NO DISC" is displayed.	<ul style="list-style-type: none">✓ Insert a disc.✓ Check if the disc is inserted upside down.✓ Wait until the moisture condensation at the lens has cleared.✓ Replace or clean the disc, see "Maintenance".✓ Use a finalized CD-RW or a correct MP3-CD format disc.
"DISC NOT FINALIZED" is displayed.	<ul style="list-style-type: none">✓ Use a finalised CD-RW or CD-R.

Radio reception is poor.

- ✓ If the signal is too weak, adjust the antenna or connect an external antenna for better reception.
- ✓ Increase the distance between the Mini HiFi System and your TV or VCR.

Recording or playback cannot be made.

- ✓ Clean deck parts, see "Maintenance".
- ✓ Use only NORMAL (IEC I) tape.
- ✓ Apply a piece of adhesive tape over the missing tab space.

The tape deck door cannot open.

- ✓ Remove and reconnect the AC power plug and switch on the system again.

The system does not react when buttons are pressed.

- ✓ Remove and reconnect the AC power plug and switch on the system again.

Sound cannot be heard or is of poor quality.

- ✓ Adjust the volume.
- ✓ Disconnect the headphones.
- ✓ Check that the speakers are connected correctly.
- ✓ Check if the stripped speaker wire is clamped.
- ✓ Make sure the MP3-CD was recorded within 32-256 kbps bit rate with sampling frequencies at 48 kHz, 44.1 kHz or 32 kHz.

The left and right sound outputs are reversed.

- ✓ Check the speaker connections and location.

The remote control does not function properly.

- ✓ Select the source (CD or TUNER, for example) before pressing the function button (▶, ◀, ▶).
- ✓ Reduce the distance between the remote control and the system.
- ✓ Insert the batteries with their polarities (+/- signs) aligned as indicated.
- ✓ Replace the batteries.
- ✓ Point the remote control directly towards the IR sensor.

The time is not working.

- ✓ Set the clock correctly.
- ✓ Press and hold CLOCK•TIMER to switch on the timer.
- ✓ If recording or tape dubbing is in progress, stop recording.

Not all lighted buttons are showing light.

- ✓ Press DIM to select DIM OFF display mode.

The Clock/Timer setting is erased.

- ✓ Power has been interrupted or the power cord has been disconnected. Reset the clock/timer.

The system displays features automatically and buttons start flashing.

- ✓ Press and hold ■ on the system to switch off the demonstration.