

Always there to help you

Register your product and get support at
www.philips.com/support



BTM1360



User manual

PHILIPS

Contents

1	Important	2
	Safety	2
	Notice	3

2	Your Micro Music System	4
	Introduction	4
	What's in the box	4
	Overview of the main unit	5
	Overview of the remote control	6

3	Get started	8
	Connect speakers	8
	Connect power	8
	Prepare the remote control	8
	Demonstrate the features	9
	Power on	9
	Set the clock	9
	Select a source	10

4	Play	11
	Play from disc	11
	Play from USB	11
	Control play	11
	Skip tracks	11
	Program tracks	12
	Play from Bluetooth-enabled devices	12

5	Listen to the radio	14
	Tune to a radio station	14
	Program radio stations automatically	14
	Program radio stations manually	14
	Select a preset radio station	14

6	Adjust sound	15
	Select a preset sound effect	15
	Adjust volume level	15
	Mute sound	15

7	Other features	16
	Set the alarm timer	16
	Set the sleep timer	16
	Listen to an external device	16
	Charge your devices	17

8	Product information	18
	Specifications	18
	USB playability information	19
	Supported MP3 disc formats	19

9	Troubleshooting	20
----------	------------------------	-----------

1 Important

Safety

Read and understand all instructions before you use this micro music system. If damage is caused by failure to follow the instructions, the warranty does not apply.



This 'bolt of lightning' indicates uninsulated material within the device may cause an electrical shock. For the safety of everyone in your household, please do not remove the covering.

The 'exclamation mark' calls attention to features for which you should read the enclosed literature closely to prevent operating and maintenance problems.

WARNING: To reduce the risk of fire or electric shock, the device should not be exposed to rain or moisture and objects filled with liquids, such as vases, should not be placed on the device.

CAUTION: To prevent electric shock, fully insert the plug. (For regions with polarized plugs: To prevent electric shock, match wide blade to wide slot.)

Warning

- Never remove the casing of this apparatus.
- Never lubricate any part of this apparatus.
- Never look into the laser beam inside this apparatus.
- Never place this apparatus on other electrical equipment.
- Keep this apparatus away from direct sunlight, naked flames or heat.
- Ensure that you always have easy access to the power cord, plug or adaptor to disconnect the apparatus from the power.

- The device shall not be exposed to dripping or splashing.
- Do not place any source of danger on the device (e.g. liquid filled objects, lit candles).
- Where the MAINS plug or an appliance coupler is used as the disconnect device, the disconnect device shall remain readily operable.
- Make sure that there is enough free space around the product for ventilation.
- Battery usage **CAUTION** – To prevent battery leakage which may result in bodily injury, property damage, or damage to the unit:
 - Install all batteries correctly, + and - as marked on the unit.
 - Do not mix batteries (old and new or carbon and alkaline, etc.).
 - Batteries (packed or installed) shall not be exposed to excessive heat such as sunshine, fire or the like.
 - Remove batteries when the unit is not used for a long time.
- Only use attachments/accessories specified by the manufacturer.

Notice

Any changes or modifications made to this device that are not expressly approved by WOOX Innovations may void the user's authority to operate the equipment.

Compliance

This apparatus includes this label:



Care of the environment



WARNING: Care with the use and disposal of batteries.

- Do not dispose of batteries along with normal household waste.
- The improper disposal of batteries may present risks to the environment and human health.
- In order to contribute to environmental quality and your health, Philips will accept batteries sold or supplied with its products that have reached the end of their life; these will be forwarded for environmentally correct disposal. Philips provides collection points at Technical Assistance.

Environmental information

All unnecessary packaging has been omitted. We have tried to make the packaging easy to separate into three materials: cardboard (box), polystyrene foam (buffer) and polyethylene (bags, protective foam sheet.)

Your system consists of materials which can be recycled and reused if disassembled by a specialized company. Please observe the local regulations regarding the disposal of packaging materials, exhausted batteries and old equipment.

Bluetooth

The Bluetooth® word mark and logos are registered trademarks owned by Bluetooth SIG, Inc. and any use of such marks by WOOX Innovations is under license.



The making of unauthorized copies of copy-protected material, including computer programs, files, broadcasts and sound recordings, may be an infringement of copyrights and constitute a criminal offence. This equipment should not be used for such purposes.

Care for your product

- Do not insert any objects other than discs into the disc compartment.
- Do not insert warped or cracked discs into the disc compartment.
- Remove the discs from the disc compartment if you are not using the product for an extended period of time.
- Only use microfiber cloth to clean the product.

Note

- The type plate is located on the back of the product.

2 Your Micro Music System

Congratulations on your purchase, and welcome to Philips! To fully benefit from the support that Philips offers, register your product at www.philips.com/welcome.

Introduction

With this unit, you can:

- enjoy audio from discs, USB devices, Bluetooth devices, and other external devices;
- listen to radio stations.

You can enrich sound output with below sound effect:

- Digital Sound Control (DSC)

The unit supports these media formats:



What's in the box

Check and identify the contents of your package:

- Main unit
- Remote control (with one AAA battery)
- AC power cord
- Round to flat pin adaptor
- Speaker boxes (×2)
- Short user manual

Overview of the main unit

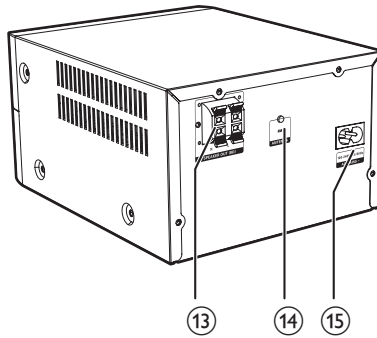
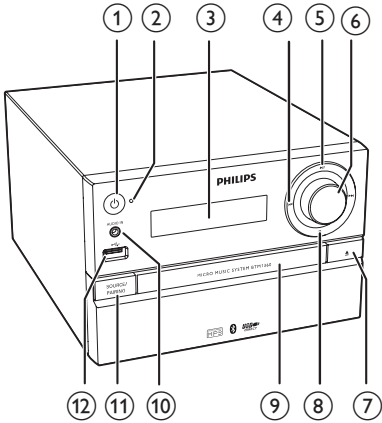



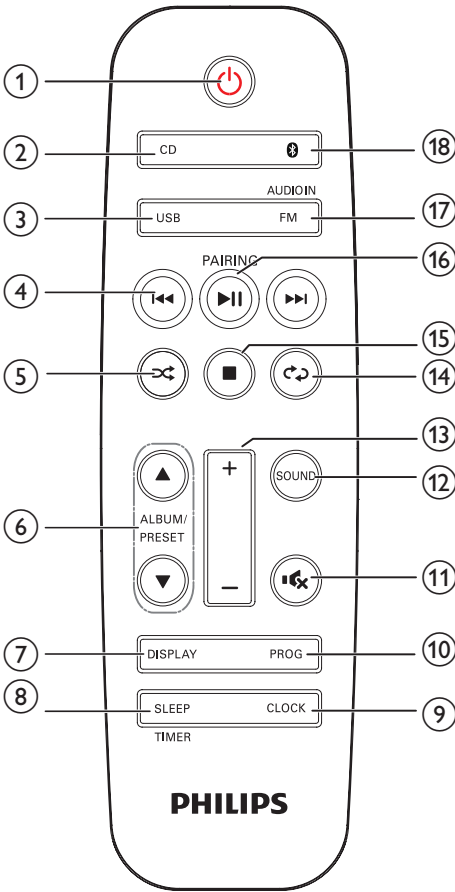

- ① **Power**
- Turn on the product.
 - Switch to standby mode or ECO power standby mode.
- ② **Bluetooth indicator**
- Indicate the Bluetooth connection status.
- ③ **Display panel**
- Show current status.
- ④ **Navigation buttons**
- Skip to previous/next track.
 - Search within a track/disc.
 - Tune to a radio station.
 - Adjust time.
- ⑤ **Play/Pause**
- Start or pause play.
- ⑥ **VOLUME knob**
- Adjust volume.
- ⑦ **Disc compartment**
- Open or close the disc compartment.
- ⑧ **Stop/Erase**
- Stop play.
 - Erase a program.
- ⑨ **Disc compartment**
- ⑩ **AUDIO IN**
- Connect external audio devices.
- ⑪ **SOURCE/PAIRING**
- Press to select a source: DISC, USB, TUNER, AUDIO IN, BT.
 - In Bluetooth mode, press and hold for three seconds until you hear a beep sound to disconnect the currently connected device and enter pairing mode.
- ⑫ **USB**
- Connect USB storage devices.
- ⑬ **SPEAKER OUT socket**
- Connect with the speakers.
- ⑭ **ANTENNA socket**
- Connect with the FM antenna.
- ⑮ **AC MAINS ~ socket**

Overview of the remote control



- ① 
- Turn the product on or off.
 - Switch to standby mode or ECO power standby mode.
- ② **CD**
- Select CD source.
- ③ **USB**
- Select USB source.

- ④ 
- Skip to the previous/next track.
 - Search within a track/disc/USB.
 - Tune to a radio station.
 - Adjust time.
- ⑤ 
- Play tracks randomly.
- ⑥ **ALBUM/PRESET ▲ / ▼**
- Select a preset radio station.
 - Skip to previous/next album.
- ⑦ **DISPLAY**
- Adjust display brightness.
 - During playback, display the play information.
- ⑧ **SLEEP/TIMER**
- Set sleep timer.
 - Set alarm timer.
- ⑨ **CLOCK**
- Set the clock.
 - View clock information.
- ⑩ **PROG**
- Program tracks.
 - Program radio stations.
 - Auto store FM radio stations.
- ⑪ 
- Mute or restore volume.
- ⑫ **SOUND**
- Enrich sound effect with Digital Sound Control (DSC).
- ⑬ **VOL +/-**
- Adjust volume.
- ⑭ 
- Play a track or all tracks repeatedly.
- ⑮ 
- Stop play or erase a program.
- ⑯ **▶||/PAIRING**
- Press to start, pause, or resume play.
 - Press and hold for three seconds until you hear a beep sound to enter pairing mode.

⑰ FM/AUDIO IN

- Select FM source.
- Select AUDIO IN source.

⑱ 

- Select Bluetooth source.

3 Get started

! Caution

- Use of controls or adjustments or performance of procedures other than herein may result in hazardous laser exposure or other unsafe operation.

Always follow the instructions in this chapter in sequence.

Connect speakers

≡ Note

- Insert the stripped portion of each speaker wire into the socket completely.
- For better sound quality, use the supplied speakers only.

- 1 For the right speaker, find the sockets on the back of the main unit marked "R".
- 2 Insert the red wire into the red (+) socket, and the black wire into the black (-) socket.
- 3 For the left speaker, find the sockets on the main unit marked "L".
- 4 Repeat step 2 to insert the left speaker wire.

To insert each speaker wire:

- 1 Hold down the socket flap.
- 2 Insert the speaker wire fully.
- 3 Release the socket flap.

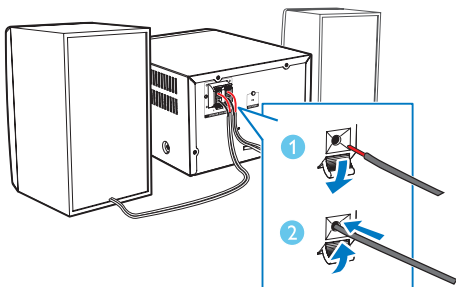

Connect power

! Caution

- Risk of product damage! Ensure that the power supply voltage corresponds to the voltage printed on the back or the underside of the unit.
- Before you connect the AC power cord, ensure that you have completed all other connections.

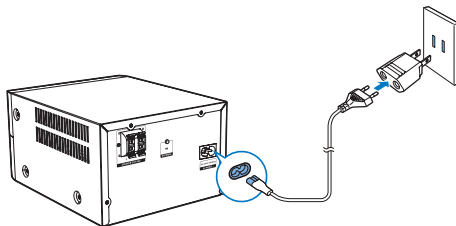

Connect the power cord to:

- the **AC MAINS ~** socket on the main product.
- the wall outlet.

Prepare the remote control

! Caution

- Risk of product damage! When the remote control is not used for long periods, remove the batteries.

To insert the remote control battery:

- 1 Open the battery compartment.
- 2 Insert the supplied AAA battery with correct polarity (+/-) as indicated.
- 3 Close the battery compartment.

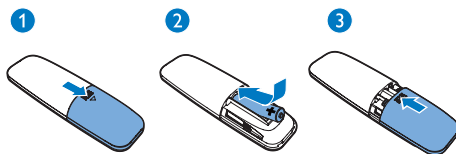

Demonstrate the features

In standby mode, press **■** to demonstrate features of this device.

- ↳ The features are displayed one by one across the display panel.
- To turn off the demonstration, press **■** again.

Power on

Press **⏻**.

- ↳ The product switches to the last selected source.

Switch to standby mode

Press **⏻** again to switch the product to standby mode.

- ↳ The clock (if set) is displayed on the panel.
- In standby mode, press **⏻** to switch between working mode and standby mode.

Note

- The product switches to standby mode after 15 minutes inactive.

Switch to ECO power standby mode

Press and hold **⏻** for more than two seconds.

- ↳ The red ECO power standby indicator turns on.
- In Eco power standby mode, press **⏻** to switch between working mode and ECO power standby mode.

Note

- The product switches to ECO power standby mode after 15 minutes in standby mode.

Switch between standby mode and ECO powerstandby mode:

- Press and hold **⏻** for more than two seconds.

Note

- If no button is pressed over 15 minutes in standby mode, this product goes to ECO standby mode automatically.

Set the clock

- 1 In standby mode, press and hold **CLOCK** for more than two seconds to enter the clock setting mode.
 - ↳ **[24H]** or **[12H]** is displayed.
- 2 Press **⏪** / **⏩** to select **24H** or **12H** hour format, and then press **CLOCK**.
 - ↳ The hour digits begin to blink.
- 3 Press **⏪** / **⏩** to set the hour, and then press **CLOCK**.
 - ↳ The minute digits begin to blink.
- 4 Press **⏪** / **⏩** to set the minute, and then press **CLOCK**.
 - ↳ The set clock is displayed.

Note

- To view clock information in working mode, press **CLOCK**.
- If no button is pressed in 90 seconds during setting, the product exits clock setting without saving earlier operations.

Select a source

On the main music system

Press **SOURCE** repeatedly to select a source.

- **[DISC]**: the disc in the disc compartment
- **[USB]**: .mp3 files stored on the connected USB storage device
- **[TUNER]**: the FM tuner
- **[AUDIO IN]**: the audio input through the **AUDIO IN** socket
- **[BT]**: audio on the Bluetooth device

On the remote control

Press **CD**, **FM**, **USB**, or **AUDIO IN** to select each source directly.

- **CD**: the disc in the disc compartment
- **FM**: the FM tuner
- **USB**: the .mp3 files stored on the connected USB storage device
- **AUDIO IN**: the audio input through the **AUDIO IN** socket
- **BT**: audio on the Bluetooth device

4 Play

Play from disc

- 1 Press **CD** to select CD source.
- 2 Press **▲** to open the disc compartment.
- 3 Insert a disc with the label side up.
- 4 Press **▲** to close the disc compartment.
↳ Play starts automatically. If not, press **▶||**.

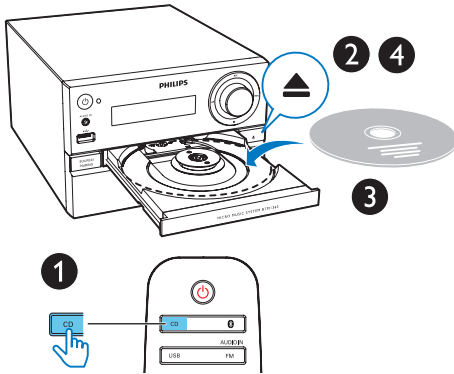

Play from USB

Note

- Make sure that the USB device contains playable audio content.

- 1 Insert a USB device into the **↔** socket.
- 2 Press **USB** to select the USB source.
↳ Play starts automatically. If not, press **▶||**.

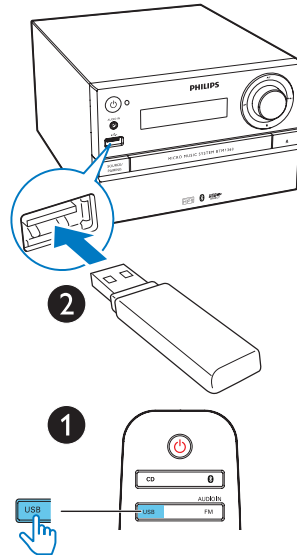

Control play

- ▶||** Start, pause, or resume play.
- Stop play.
- ▲ / ▼** Select an album or a folder.
- ⏮ / ⏭** Press to skip to the previous or next track.
- ⏮ / ⏭** Press and hold to search backward/forward within a track.
- ↺** Play a track or all tracks repeatedly.
- ↻** Play tracks randomly (Not applicable for the programmed tracks).

Skip tracks

When playing a CD:

Press **⏮ / ⏭** to select tracks.

When playing an MP3 disc and USB:

- 1 Press **▲ / ▼** to select an album or a folder.
- 2 Press **⏮ / ⏭** to select a track or a file.

Program tracks

This function allows you to program 20 tracks in the desired sequence.

- 1 In stop mode, press **PROG** to activate the program mode.
↳ **[PROG]** (program) and **[001 PR 01]** are displayed.
- 2 For MP3 tracks, press ▲ / ▼ to select an album.
- 3 Press ◀◀ / ▶▶ to select a track, and then press **PROG** to confirm.
- 4 Repeat steps 2 to 3 to program more tracks.
- 5 Press ▶|| to play the programmed tracks.
↳ During play, **[PROG]** (program) is displayed.

To erase the program

Press ■ twice.

Play from Bluetooth-enabled devices

Note

- The effective operation range between the unit and your Bluetooth enabled device is approximately 10 meters (30 feet).
- Any obstacle between the system and the device can reduce the operational range.
- Compatibility with all Bluetooth devices is not guaranteed.

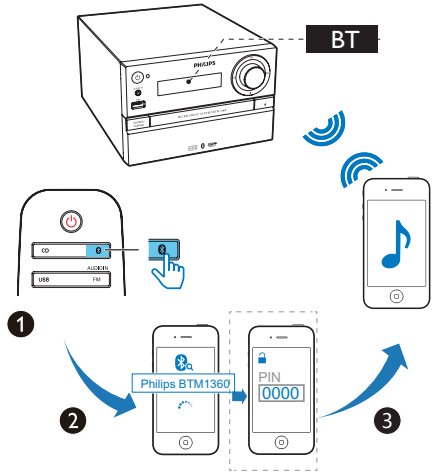

- 1 Press **BT** to select the **Bluetooth** source.
↳ **[BT]** (Bluetooth) is displayed.
↳ The Bluetooth indicator flashes blue.
- 2 On your device that supports Advanced Audio Distribution Profile (A2DP), enable Bluetooth and search for Bluetooth devices that can be paired (refer to the user manual of the device).
- 3 Select '**Philips BTM1360**' on your Bluetooth enabled device and if necessary input '0000' as the pairing password.
↳ After successful pairing and connection, the Bluetooth indicator turns solid blue, and the unit beeps twice.
- 4 Play audio on the connected device.
↳ Audio streams from your Bluetooth enabled device to this product.
 - If you fail to search for "**Philips BTM1360**" or cannot pair with this product, press and hold **SOURCE/PAIRING** (or ▶|| on the remote control) for three seconds until you hear a beep sound to enter pairing mode.



Tip

- The product can memorize up to 8 previously connected Bluetooth devices.

To disconnect the Bluetooth-enabled device:

- Deactivate Bluetooth on your device; or
- Move the device beyond the communication range.

Enter Bluetooth pairing mode

Press and hold **SOURCE/PAIRING** for three seconds until you hear a beep sound to disconnect the currently connected device and enter Bluetooth pairing mode.

Clear Bluetooth pairing history

- Press and hold **■** on the main set for 8 seconds.
 - ↳ The current Bluetooth connection is disconnected.
 - ↳ After successful clearing, the product beeps.

5 Listen to the radio

Tune to a radio station



Tip

- Position the antenna as far as possible from TV, VCR, or other radiation source.
- For optimal reception, fully extend and adjust the position of the antenna.

- 1 Press **FM/AUDIO IN** repeatedly to select FM source.
- 2 Press and hold **◀▶** for more than two seconds.
↳ The radio tunes to a station with strong reception automatically.
- 3 Repeat step 2 to tune to more stations.

To tune to a weak station:

Press **◀▶** repeatedly until you find optimal reception.

Program radio stations manually

- 1 Tune to a radio station.
- 2 Press **PROG** to activate program mode.
↳ **[PROG]** (program) displays on the screen.
- 3 Press **▲ / ▼** to allocate a number from 1–20 to this radio station, and then press **PROG** to confirm.
↳ The preset number and the frequency of the preset station are displayed.
- 4 Repeat steps 1-3 to program more stations.



Note

- To overwrite a programmed station, store another station in its place.

Program radio stations automatically



Note

- You can program a maximum of 20 preset radio stations (FM).

In tuner mode, press and hold **PROG** for more than two seconds to activate automatic programming.

- ↳ All available stations are programmed in the order of waveband reception strength.
- ↳ The first programmed radio station is broadcast automatically.

Select a preset radio station

In tuner mode, press **▲ / ▼** to select a preset number.

6 Adjust sound

The following operations are applicable to all supported media.

Select a preset sound effect

- Press **SOUND** repeatedly to select a preset sound effect.
 - **DSC1**, **DSC2**, **DSC3**, **DSC4**, and **DSC5**

Adjust volume level

- On the remote control, press **VOL +/-** repeatedly.
- On the main unit, rotate the volume knob.

Mute sound

- Press **MUTE** to mute or unmute the sound.

7 Other features

Set the alarm timer

This product can be used as an alarm clock. You can select the disc, FM, or .mp3 files on a USB storage device as alarm source.

Note

- Make sure that you have set the clock correctly.
- If the selected alarm source is unavailable, this product switches to FM mode automatically.

- 1 In normal standby mode, press and hold **SLEEP/TIMER** for two seconds.
↳ The hour digits blink.
↳ ☹ is displayed.
- 2 Press **◀◀** / **▶▶** repeatedly to set the hour, and then press **SLEEP/TIMER** to confirm.
↳ The minute digits blink.
- 3 Press **◀◀** / **▶▶** to set the minute, and then press **SLEEP/TIMER** to confirm.
↳ The last selected alarm source blinks.
- 4 Press **◀◀** / **▶▶** to select an alarm source (DISC, USB or Tuner), and then press **SLEEP/TIMER** to confirm.
↳ **VOL_XX** (XX indicates the volume level of alarm) blinks.
- 5 Press **◀◀** / **▶▶** to set the alarm volume, and then press **SLEEP/TIMER** to confirm.

Activate/deactivate alarm timer

In standby mode, press **SLEEP/TIMER** repeatedly to activate or deactivate timer.

- ↳ If timer is activated, ☹ is displayed.

Tip

- Alarm timer is not available in AUDIO IN mode.

Note

- If CD/USB source is selected, but no disc is placed or no USB device is connected, the TUNER source is selected automatically.

Set the sleep timer

This music system can switch to standby automatically after a set period of time.

- When the music system is turned on, press **SLEEP/TIMER** repeatedly to select a set period of time (in minutes).
↳ When sleep timer is activated, **zZ** is displayed.

To deactivate sleep timer

- Press **SLEEP/TIMER** repeatedly until **[OFF]** (sleep off) is displayed.
↳ When sleep timer is deactivated, **zZ** disappears.

Listen to an external device

You can listen to an external device through this unit with an MP3 link cable.

- 1 Connect an MP3 link cable (not supplied) between:
 - **AUDIO IN** jack (3.5 mm) on the product,
 - and the headphone jack on an external device.
- 2 Press **FM/AUDIO IN** repeatedly to select **AUDIO IN** source.
- 3 Start to play the device (see the device user manual).

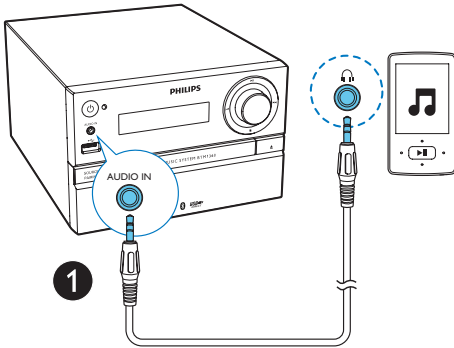

1

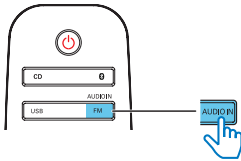

2

Note

- Philips does not guarantee the compatibility of this product with all devices.

Charge your devices

With this micro music system, you can charge your external devices, such as your cell phone, MP3 player or other mobile devices.

- 1 Use a USB cable to connect the USB socket of product with the USB socket of your devices.

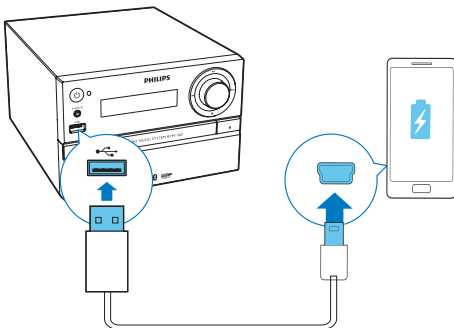

- 2 Connect the product to power.
 - ↳ Once the device is recognized, the charging starts.

8 Product information

Note

- Product information is subject to change without prior notice.

Specifications

Amplifier

Total Output Power	Maximum 30 W
Frequency Response	60 Hz - 20 kHz; ±3 dB
Signal to Noise Ratio	≥75 dBA
Total Harmonic Distortion	<1%
Aux Input	600 mV ± 100 mV RMS 22 kohm

Speakers

Speaker Impedance	4 ohm
Speaker Driver	Full range 3.5"
Sensitivity	83 ± 3dB/m/W

Tuner (FM)

Tuning Range	87.5-108 MHz
Tuning grid	50 KHz
Sensitivity	
- Mono, 26dB S/N Ratio	<22 dBf
- Stereo, 46dB S/N Ratio	<45 dBf
Search Selectivity	<30 dBf
Total Harmonic Distortion	<3%
Signal to Noise Ratio	>45 dB

USB

USB Direct Version	2.0 Full Speed
Charging support	5V, 500mA

Disc

Laser Type	Semiconductor
Disc Diameter	12 cm/8 cm
Support Disc	CD-DA, CD-R, CD-RW, MP3-CD
Audio DAC	24 Bits/44.1 KHz
Total Harmonic Distortion	<3% (1 KHz)
Frequency Response	20 Hz - 20 kHz (44.1 KHz)
S/N Ratio	≥80 dBA

Bluetooth

Bluetooth Version	V4.0
Bluetooth Frequency Band	2.4 GHz ~ 2.48 GHz ISM Band
Bluetooth Range	10 m (free space)

General information

AC power	100-240 V~, 50/60 Hz
Operation Power Consumption	< 20 W
Eco Standby Power Consumption	< 0.5 W
Dimensions	
- Main Unit (W x H x D)	180 x 121 x 227 mm
- Speaker Box (W x H x D)	120 x 195 x 143 mm
Weight	
- Main Unit	1.54 kg
- Speaker Box	0.81 kg x 2

USB playability information

Compatible USB devices:

- USB flash memory (USB2.0 or USB1.1)
- USB flash players (USB2.0 or USB1.1)
- memory cards (requires an additional card reader to work with this unit)

Supported USB formats:

- USB or memory file format: FAT12, FAT16, FAT32 (sector size: 512 bytes)
- MP3 bit rate (data rate): 32-320 Kbps and variable bit rate
- Directory nesting up to a maximum of 8 levels
- Number of albums/ folders: maximum 99
- Number of tracks/titles: maximum 999
- File name in Unicode UTF8 (maximum length: 32 bytes)

Unsupported USB formats:

- Empty albums: an empty album is an album that does not contain MP3/WMA files, and will not be shown in the display.
- Unsupported file formats are skipped. For example, word documents (.doc) or MP3 files with extension .dlf are ignored and not played.
- WMA, AAC, WAV, PCM audio files
- DRM protected WMA files (.wav, .m4a, .m4p, .mp4, .aac)
- WMA files in Lossless format

Supported MP3 disc formats

- ISO9660, Joliet
- Maximum title number: 128 (depending on file name length)
- Maximum album number: 99
- Supported sampling frequencies: 32 kHz, 44.1 kHz, 48 kHz
- Supported Bit-rates: 32~256 (kbps), variable bit rates

9 Troubleshooting



Warning

- Never remove the casing of this device.

To keep the warranty valid, never try to repair the system yourself.

If you encounter problems when using this device, check the following points before requesting service. If the problem remains unsolved, go to the Philips Web page (www.philips.com/support). When you contact Philips, make sure that the device is nearby and the model number and serial number are available.

No power

- Make sure that the AC power cord of the device is connected properly.
- Make sure that there is power at the AC outlet.
- As a power-saving feature, the system switches off automatically 15 minutes after track play reaches the end and no control is operated.

No sound or poor sound

- Adjust the volume.
- Check that the speakers are connected correctly.
- Check if the stripped speaker wires are clamped.

No response from the unit

- Disconnect and reconnect the AC power plug, then turn on the unit again.
- As a power-saving feature, the system switches off automatically 15 minutes after track play reaches the end and no control is operated.

Remote control does not work

- Before you press any function button, first select the correct source with the remote control instead of the main unit.
- Reduce the distance between the remote control and the unit.

- Insert the battery with its polarities (+/- signs) aligned as indicated.
- Replace the battery.
- Aim the remote control directly at the sensor on the front of the unit.

No disc detected

- Insert a disc.
- Check if the disc is inserted upside down.
- Wait until the moisture condensation at the lens has cleared.
- Replace or clean the disc.
- Use a finalized CD or correct format disc.

Cannot display some files in USB device

- The number of folders or files in the USB device has exceeded a certain limit. This phenomenon is not a malfunction.
- The formats of these files are not supported.

USB device not supported

- The USB device is incompatible with the unit. Try another one.

Poor radio reception

- Increase the distance between the unit and your TV or other radiation sources.
- Fully extend the FM antenna.

Music playback is unavailable on this unit even after successful Bluetooth connection.

- The device cannot be used to play music through this unit wirelessly.

The audio quality is poor after connection with a Bluetooth-enabled device.

- The Bluetooth reception is poor: Move the device closer to this unit or remove any obstacle between them.

Bluetooth cannot be connected with this unit.

- The device does not support the profiles required for this unit.
- The Bluetooth function of the device is not enabled. Refer to the user manual of the device to find out how to enable the function.
- This unit is not in pairing mode.

- This unit is already connected with another Bluetooth-enabled device. Disconnect that device and then try again.

The paired mobile device connects and disconnects constantly.

- The Bluetooth reception is poor. Move the device closer to this unit or remove any obstacle between them.
- Some mobile phones may connect and disconnect constantly when you make or end calls. This does not indicate any malfunction of this unit.
- For some devices, the Bluetooth connection may be deactivated automatically as a power-saving feature. This does not indicate any malfunction of this unit.

Timer does not work

- Set the clock correctly.
- Switch on the timer.

Clock/timer setting erased

- Power has been interrupted or the power cord has been disconnected.
- Reset the clock/timer.



Copyright © 2015 Gibson Innovations Limited. Revised Edition © 2017

This product has been manufactured by, and is sold under the responsibility of Gibson Innovations Ltd., and Gibson Innovations Ltd. is the warrantor in relation to this product.

Philips and the Philips Shield Emblem are registered trademarks of Koninklijke Philips N.V. and are used under license.

BTM1360_55_UM_V2.0

