

Register your product and get support at
www.philips.com/welcome

CED1700



EN	User manual	3
RU	Руководство пользователя	33

PHILIPS

Contents

1 Important	4
Safety	4
Notice	4
Introduction	5
What's in the box	6
Overview of the main unit	7
Overview of the remote control	9
2 Get started	10
Install the car audio	10
Install remote control battery	14
Turn on	15
Set date and time	15
3 Listen to radio	16
Tune to a radio station	16
Store radio stations in memory	16
Tune to a preset station	16
Play with RDS	17
4 Play	18
Load discs	18
Connect USB device	19
Insert SD/MMC card	19
Play/Pause	20
Repeat	20
Skip/search	20
Search within a title/folder	20
Random play	21
Select audio language	21
Select subtitle language	21
Rotate pictures	21
Zoom	22
5 Play with Bluetooth device	22
Pair the Bluetooth-enabled devices	22
Make a call	23
Receive call	23
Listen to music from Bluetooth device	24
Adjust Bluetooth settings	24
6 Adjust sound	25
Adjust volume	25
Mute	25
Select preset equalizer	25
Adjust fader/balance	25
Adjust Subwoofer value	26
Set Dynamic Bass Boost (DBB)	26
7 Adjust settings	26
Adjust general settings	26
Adjust Bluetooth settings	27
8 Others	27
Listen to other devices	27
Reset	27
Remove the unit	28
Replace fuse	28
9 Product information	29
10 Troubleshooting	30
About Bluetooth device	31
11 Glossary	32

1 Important

Safety

- Read and understand all instructions before you use your apparatus. If damage is caused by failure to follow instructions, the warranty does not apply.
- This apparatus is designed for negative ground (earth) 12 V DC operation only.
- To ensure safe driving, adjust the volume to a safe and comfortable level.
- Improper fuses can cause damage or fire. When you need to change the fuse, consult a professional.
- Use only the supplied mounting hardware for a safe and secure installation.
- To avoid short circuit, do not expose the apparatus, remote control or remote control batteries to rain or water.
- Never insert objects into the ventilation slots or other openings on the apparatus.
- Clean the apparatus and frame with a soft, damp cloth. Never use substances such as alcohol, chemicals or household cleaners on the apparatus.
- Never place any objects other than discs into the apparatus.
- Never use solvents such as benzene, thinner, cleaners available commercially, or anti-static sprays intended for discs.
- Visible and invisible laser radiation when open. Avoid exposure to beam.
- Risk of damage to the apparatus screen! Never touch, push, rub or strike the screen with any object.
- The apparatus shall not be exposed to dripping or splashing.
- Do not place any sources of danger on the apparatus (e.g. liquid filled objects, lighted candles).

Notice



The making of unauthorized copies of copy-protected material, including computer programs, files, broadcasts and sound recordings, may be an infringement of copyrights and constitute a criminal offence. This equipment should not be used for such purposes.

The Bluetooth® word mark and logos are registered trademarks owned by Bluetooth SIG, Inc. and any use of such marks by Philips is under license.



Manufactured under license from Dolby Laboratories.

“Dolby” and the double-D symbol are trademarks of Dolby Laboratories.



ABOUT DIVX VIDEO: DivX® is a digital video format created by DivX, Inc. This is an official DivX Certified device that plays DivX video. Visit www.divx.com for more information and software tools to convert your files into DivX video.

ABOUT DIVX VIDEO-ON-DEMAND: This DivX Certified® device must be registered in order to play DivX Video-on-Demand (VOD) content. To generate the registration code, locate the DivX VOD section in the device setup menu. Go to vod.divx.com with this code to complete the registration process and learn more about DivX VOD.

DivX®, DivX Certified® and associated logos are registered trademarks of DivX, Inc. and are used under license.

DivX Certified® to play DivX® video, including premium content

Other trademarks and trade names are those of their respective owners.

This apparatus includes this label:



Environmental information

All unnecessary packaging has been omitted. We have tried to make the packaging easy to separate into three materials: cardboard (box), polystyrene foam (buffer) and polyethylene (bags, protective foam sheet.)

Your system consists of materials which can be recycled and reused if disassembled by a specialized company. Please observe the local regulations regarding the disposal of packaging materials, exhausted batteries and old equipment.



This product complies with the radio interference requirements of the European Community.

Any changes or modifications made to this device that are not expressly approved by Philips Consumer Lifestyle may void the user's authority to operate the equipment.

Recycling



Your product is designed and manufactured with high quality materials and components, which can be recycled and reused.

When you see the crossed-out wheel bin symbol attached to a product, it means the product is covered by the European Directive 2002/96/EC:



Never dispose of your product with other household waste. Please inform yourself about the local rules on the separate collection of electrical and electronic products. The correct disposal of your old product helps prevent potentially negative consequences on the environment and human health.

Your product contains batteries covered by the European Directive 2006/66/EC, which cannot be disposed of with normal household waste.

Please inform yourself about the local rules on separate collection of batteries. The correct disposal of batteries helps prevent potentially negative consequences on the environment and human health.

2011 © Koninklijke Philips Electronics N.V.

All rights reserved.

Specifications are subject to change without notice. Trademarks are the property of Koninklijke Philips Electronics N.V. or their respective owners. Philips reserves the right to change products at any time without being obliged to adjust earlier supplies accordingly. Congratulations on your purchase, and welcome to Philips! To fully benefit from the support that Philips offers, register your product at www.philips.com/welcome.

Introduction

With the car entertainment system, you can enjoy:

- Audio/video/JPEG pictures from
 - DVD, VCD or CD
 - USB devices
 - SD/SDHC/MMC cards
 - External devices
- FM or AM (MW) radio
- Audio from Bluetooth-enabled devices

Besides, you can make/receive phone calls with Bluetooth-enabled devices ~~and quickly find the destination you seek with external GPS navigation box (Philips model CEA100).~~

What's in the box

Check and identify the contents of your package:

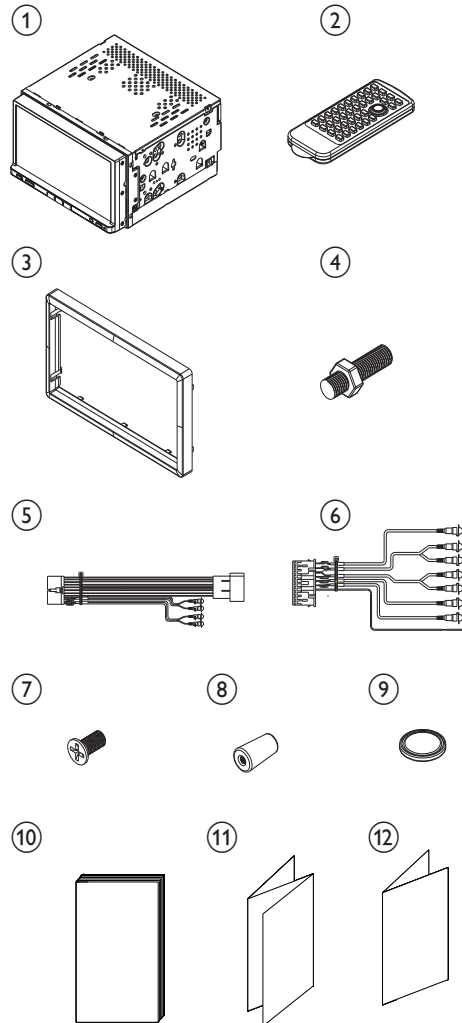

- ① Main unit and front panel
- ② Remote control
- ③ Trim plate
- ④ Hexagon head screw
- ⑤ ISO standard connector
- ⑥ Audio and Video cable
- ⑦ Screws
- M5x8mm x 4 pcs
- ⑧ Rubber cushion
- ⑨ Remote control battery
- ⑩ User manual
- ⑪ Quick start guide
- ⑫ Warranty card

Overview of the main unit

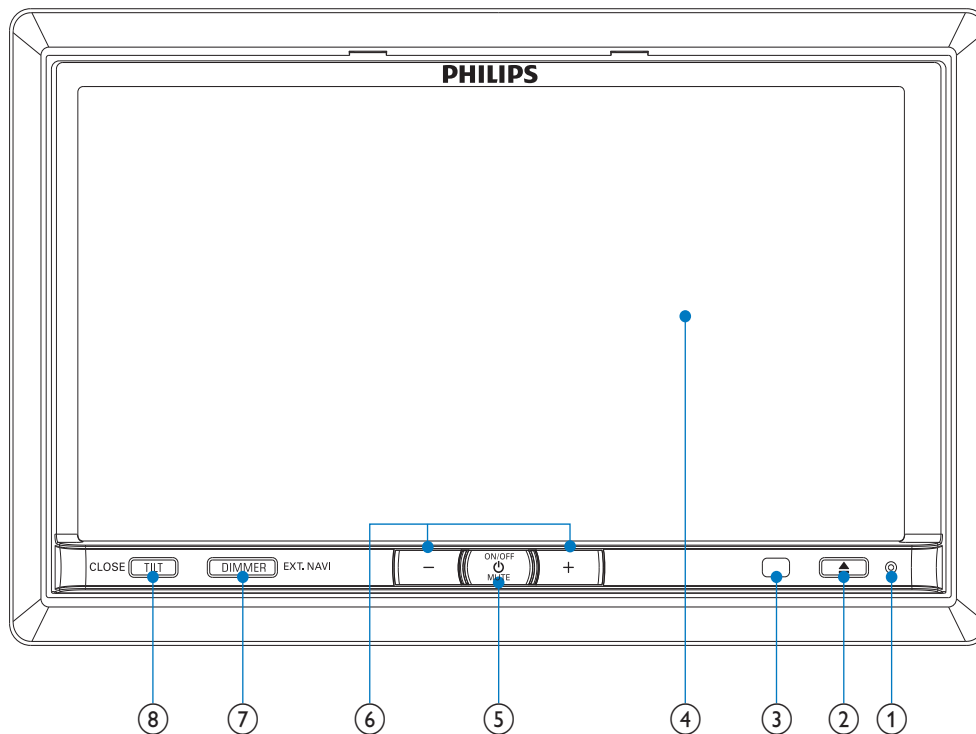

① **RESET**

② ▲

- Open the front panel to insert/eject disc/card.

③ **Remote sensor**

④ **Touch panel**

⑤ **Ⓞ/MUTE**

- Turn the unit on or off.
- Turn mute on or off.

⑥ **+/-**

- Increase/decrease volume.

⑦ **DIMMER**

- Adjust dimmer settings.
- Press and hold to enter or exit GPS navigation system

⑧ **TILT**

- Adjust the position of the front panel.
- Press and hold to close the front panel.

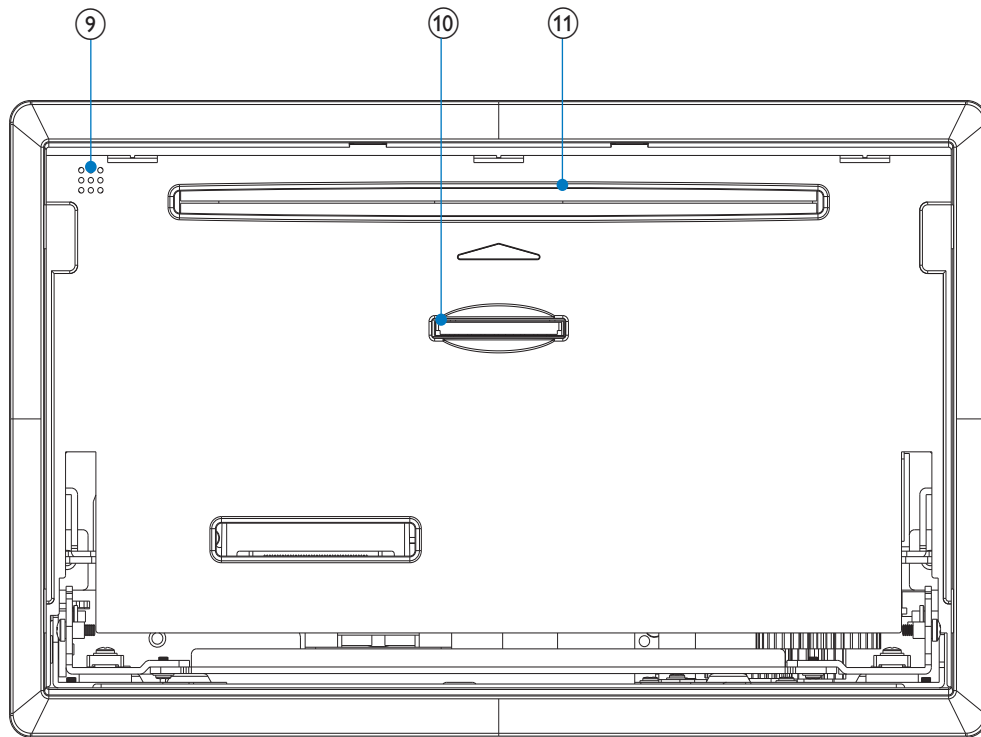

- ⑨ Built-in microphone
- ⑩ SD/SDHC/MMC card slot
- ⑪ Disc slot

Overview of the remote control

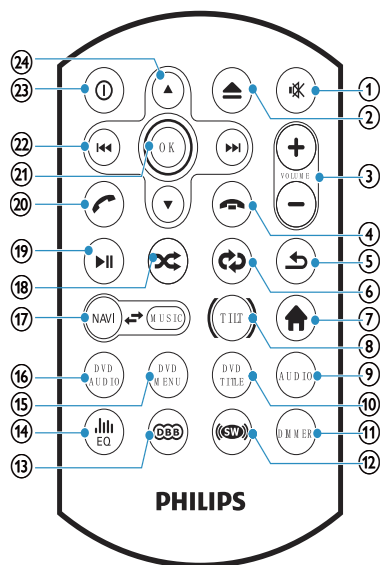

- ① **MUTE**
- Mute or unmute audio.
- ② **POWER**
- Open the front panel to insert/eject disc/card.
- ③ **VOLUME +/-**
- Adjust volume.
- ④ **REJECT**
- Terminate call.
 - Reject incoming call.
- ⑤ **EXIT**
- Return to previous menu or exit.
- ⑥ **REPEAT**
- Adjust repeat mode.
- ⑦ **HOME**
- Access home menu.
- ⑧ **TILT**
- Adjust the position of the front panel.
- ⑨ **AUDIO**
- Access speaker fader/balance menu.
- ⑩ **DVD TITLE**
- Select DVD or DivX subtitle language.
- ⑪ **DIMMER**
- Access illuminate dimmer settings.
- ⑫ **SW**
- Turn on/off subwoofer.
- ⑬ **DBB**
- Turn on or off Dynamic Bass Boost (DBB) sound.
- ⑭ **EQ**
- Access equalizer setting menu.
- ⑮ **DVD MENU**
- Access DVD main menu.
- ⑯ **DVD AUDIO**
- Select audio language or audio channel.
- ⑰ **NAVI**
- Enter/exit the navigation system.
- ⑱ **SHUFFLE**
- Adjust shuffle play mode.
- ⑲ **PLAY/PAUSE**
- Start or pause play.
- ⑳ **RECEIVE**
- Answer phone.
 - Dial number.
- ㉑ **OK**
- Confirm selection.
- ㉒ **SKIP**
- Skip to previous/next track/chapter.
 - Play fast backward/forward.
 - Tune for radio station.
- ㉓ **POWER**
- Turn the unit on or off.
- ㉔ **PRESET**
- Skip to the previous/next preset station.
 - Skip to the previous/next folder.
 - Search backward/forward for DVD video.
 - Move cursor up/down.

2 Get started

! Caution

- Use of controls or adjustments or performance of procedures other than herein may result in hazardous radiation exposure or other unsafe operation.

Always follow the instructions in this chapter in sequence.

Install the car audio

These instructions are for a typical installation. However, if your car has different requirements, make the corresponding adjustment. If you have any questions regarding installation kits, consult your Philips car audio dealer.

! Caution

- This unit is designed for negative ground (earth) 12 V DC operation only.
- Always install this unit in the car dashboard. Other locations can be dangerous as the rear of the unit heats up during use.
- To avoid short-circuit: before you connect, ensure that the ignition is off.
- Ensure that you connect the yellow and red power supply leads after all other leads are connected.
- Ensure that all loose leads are insulated with electrical tape.
- Ensure that the leads do not get caught under screws or in parts that will move (e.g. seat rail).
- Ensure that all ground (earth) leads are run to a common ground (earth) point.
- Use only the supplied mounting hardware for a safe and secure installation.
- Improper fuses can cause damage or fire. When you need to change the fuse, consult a professional.

Note on the power supply lead (yellow)

- When you connect other devices to this system, ensure that the rating of the car circuit is higher than the total fuse value of all the connected devices.

Notes on speaker connection

- Never connect speaker wires to the metal body or chassis of the car.
- Never connect speaker wires with stripes to one another.

Connect wires

! Caution

- Ensure that all loose leads are insulated with electrical tape.

- 1 Check the car's wiring carefully, then connect them to the supplied ISO wires.

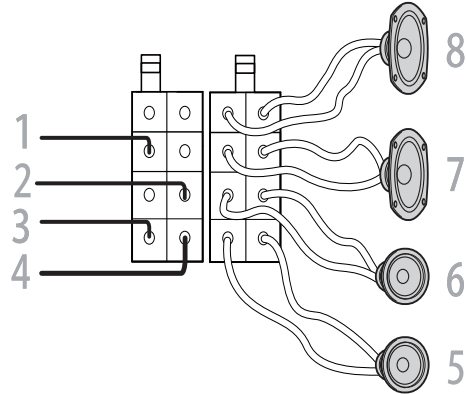

	Connector	Connect to
1	Yellow wire	The +12V car battery which is live at all times.
2	Blue wire	The electric antenna control lead or power supply lead of the antenna booster If there is no electric antenna or antenna booster, or it is manually operated telescopic antenna, it is not necessary to connect this lead.
3	Black wire	A metal surface of the car First connect the black ground (earth) lead, then connect the yellow and red power supply leads.
4	Red wire	The +12V power terminal which is live in the accessory (ACC) position of the ignition switch If there is no accessory position, connect to the +12V car battery terminal that is always live. Be sure to connect the black ground (earth) lead to a metal surface of the car first.
5	Green and green/black wires	Left speaker (Rear)
6	White and white/black wires	Left speaker (Front)
7	Gray and gray/black wires	Right speaker (Front)
8	Purple and purple/black wires	Right speaker (Rear)

- 2 Connect the other end of the supplied standard connector to the car audio system.

! Caution

- In order to avoid any accident, the driver must not watch video while driving. This unit is designed to not allow watching moving video while driving. Park your car in a safe place and engage the parking brake before watching moving video.

≡ Note

- The video blocking system under parking brake not engaged only control this unit's display, and will not affect the video output through the rear RCA video output.
- If watch moving video from Disc or AV-In source but parking brake is not properly connected, the video signal will be blocked by the system, and the below display will be shown on TFT:

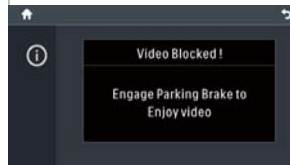

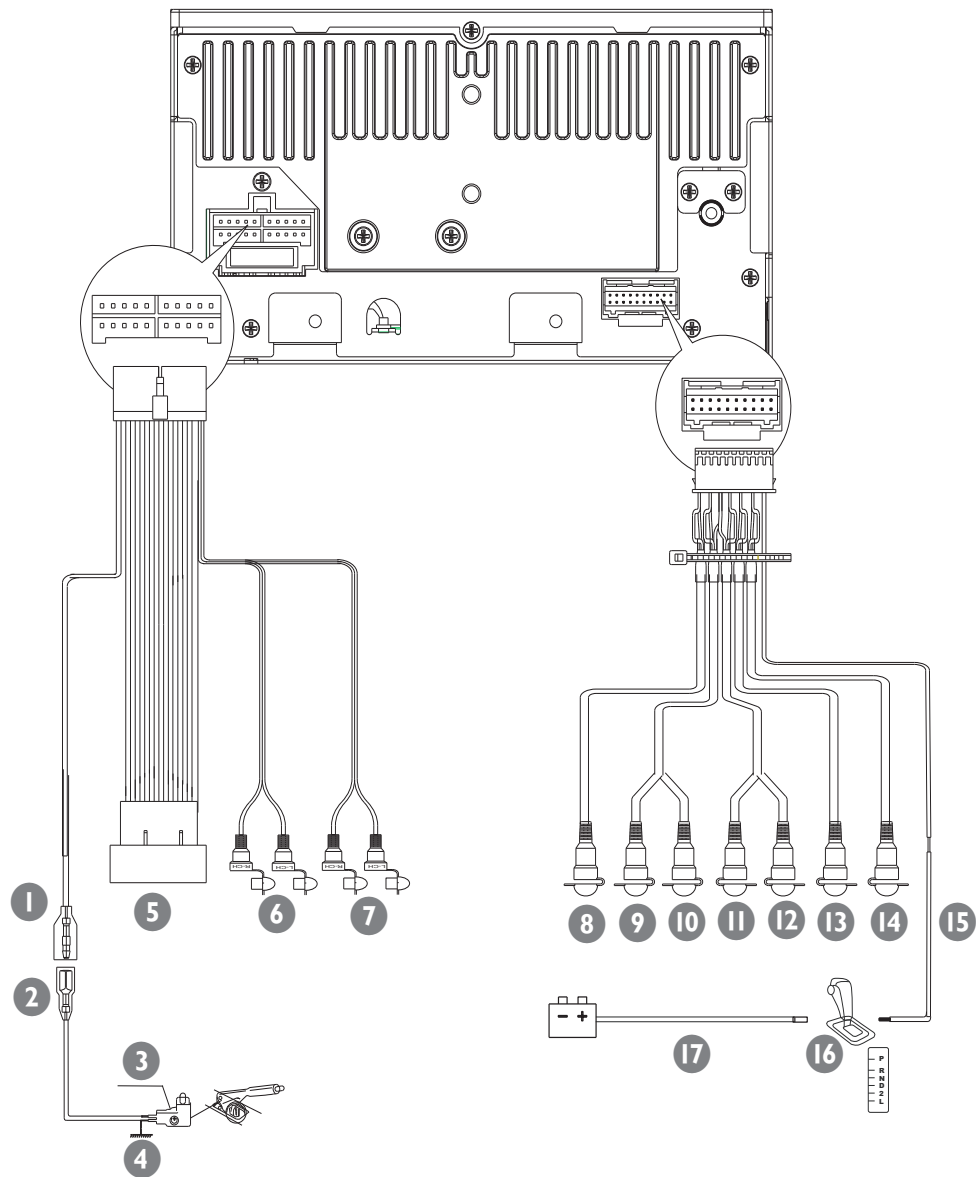

	Connector/ Object	Connect to/with
1	Pink wire	Extension wire
2	2.5m extension wire (Not included)	Parking brake (-)
3	Brake switch	
4	Ground	
5	ISO wires	Connected in step 1 above.
6	Grey wire	Rear line out Left/Right
7	Black wire	Front line out Left/Right
8	Blue cable	Subwoofer
9	Red cable	Aux Right
10	White cable	Aux Left
11	Yellow cable	Video in
12	Yellow cable	Camera in
13	Yellow cable	Video out 1
14	Yellow cable	Video out 2
15	Purple wire	Reverse camera (B+)
16	Gearbox switch	
17	Reverse gear	Back lamp lead + signal

Connect radio antenna

Connect the radio antenna to the radio antenna of the system for better radio signal.

- 1 Connect the radio antenna to the car antenna.

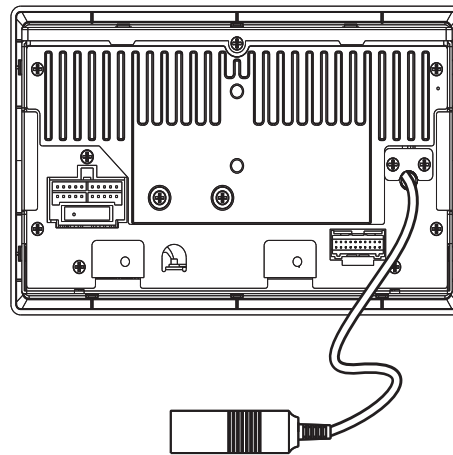

English

Mount in the dashboard

Note

- Check wire connection before you mount the unit into a car.
- If preset radio stations are lost when the ignition key is turned OFF and then back ON, reconnect the red leads crosswise to the yellow ones.

- 1 If the car does not have an on-board drive or navigation computer, disconnect the negative terminal of the car battery.
 - If you disconnect the car battery in a car that has an on-board drive or navigation computer, the computer may lose its memory.
 - If the car battery is not disconnected, to avoid short-circuit, ensure that bare wires do not touch each other.
- 2 Ensure that car dashboard opening is within these measurements:

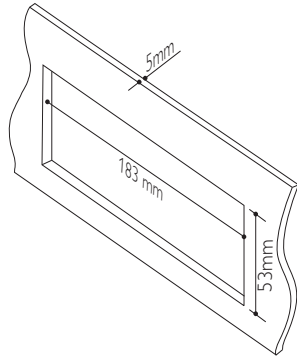

- Since the unit cannot be used if the dashboard opening's slant angle is above 20 degrees: Ensure that the horizontal slant of the car dashboard opening is between 0 and 20 degrees.

3 Slide the unit into the dashboard until a click sound is heard.

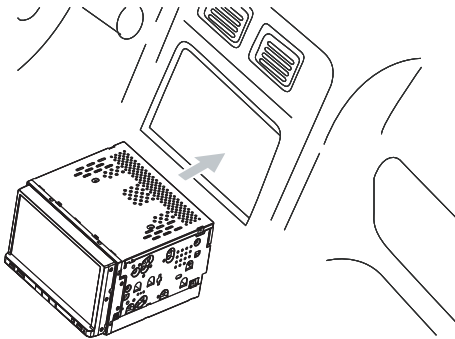

4 Attach the trim plate.

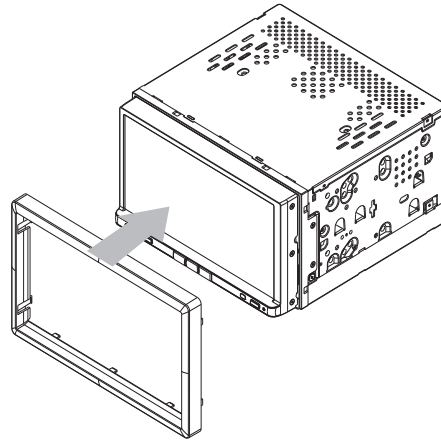

5 Reconnect the negative terminal of the car battery.

Install remote control battery

! Caution

- Risk of explosion! Keep batteries away from heat, sunshine or fire. Never discard batteries in fire.

≡ Note

- Remove batteries if they are exhausted or if the remote control is not to be used for a long time.
- Batteries contain chemical substances, they should be disposed of properly.
- Perchlorate Material - special handling may apply. See www.dtsc.ca.gov/hazardouswaste/perchlorate

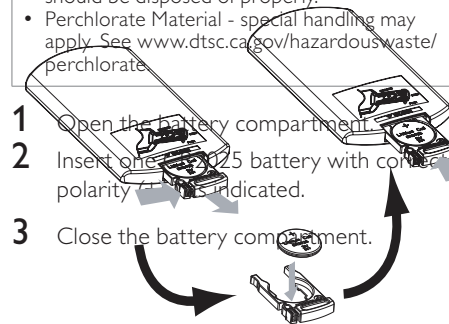

Turn on

! Caution

- Risk of road accidents! Never watch video or adjust settings while you drive.

- 1 Press **⊕** to turn on the unit.
 - ↳ The available OSD (On-Screen Display) languages are displayed.



- 2 Touch a language to select.
 - ↳ The OSD language is changed to the selected language immediately.
 - To adjust screen brightness, press **DIMMER** on the remote control, then press **▲** or **▼**.
 - To turn off the unit, press and hold **⊕** for 3 seconds.

Set date and time

- 1 Touch **⬆** to display main menu.
- 2 Touch **[Settings]**.
 - ↳ Setting menu displays.
- 3 Touch **⬇** to access 2nd page.
- 4 Touch **[Date]**.
- 5 Touch year digit to highlight this digit.
- 6 Touch **⬅▶** to set year.
- 7 Repeat step 5 and 6 to set month and day.

Set Time

- 1 Touch **[Set Time]**.
- 2 Touch hour/minute digit to highlight the digit.

- 3 Touch **⬅▶** to set hour/minute.

Set time format

- 1 Touch **[Clock Mode]** repeatedly to toggle between **[12Hr]** and **[24Hr]** options.

* Tip





- When date/time is set, touch **⬆** to go back to the upper level menu, or touch **⬆** to go to the main menu.

3 Listen to radio

Tune to a radio station

- 1 Touch  to display home menu.
- 2 Touch **[Radio]**.
↳ Radio screen displays.



- 3 Touch on **FM** or **AM** repeatedly on the left of the screen to select band:
 - FM band options: **FM1, FM2, FM3**
 - AM band options: **AM1, AM2**
- 4 Briefly touch  or  to tune to a radio station by step.
 - Touch  or  for over 1 seconds to tune to a radio station automatically.

Select radio range

Before you start to search for radio stations, you can select radio range.

- 1 Touch .
- 2 Touch **[Radio range]** to toggle tuner sensitivity from normal to high sensitivity.
 - **[Distance]**: Only stations with strong signals can be broadcast.
 - **[Local]**: Stations with strong and weak signals can be broadcast.

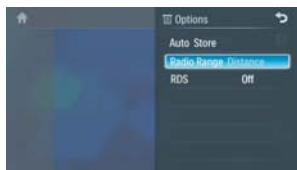

Store radio stations in memory

You can store up to 6 stations in each band.

Store stations manually

- 1 Select a band.
- 2 Tune to the station you want to store.
- 3 Touch and hold one of the channels **01** to **06** over 2 seconds.
↳ The station is saved under the selected channel.

Store stations automatically

You can search for a station with intro search, which broadcasts a 10-second preview of each detected radio station.

- 1 Select band.
- 2 Touch .
- 3 Touch **[Auto Store]**.
↳ Auto search starts. The six strongest stations of the selected band are saved in preset channels 1-6 automatically.

Tune to a preset station

- 1 Tap **[Radio]**.
- 2 Select band.
- 3 Tap one of the preset channels (**01** to **06**) to select a preset station.



Play with RDS

The RDS (Radio Data System) function operates only in areas with FM stations broadcasting RDS signals. If you tune to an RDS station, an RDS icon and the station name are displayed.

Activate AF/TA/REG/CT functions

- 1 Under radio mode, Touch **☰**.
↳ The radio option menu is displayed.
- 2 Touch **[Off]** after **[RDS]**.
↳ RDS turns on.



- 3 Touch on each option repeatedly to turn on/off the corresponding function.
 - AF (alternate frequency): automatically searches for a different station when the tuner cannot get a good reception.
 - TA (traffic announcement): allows you to receive traffic announcements automatically no matter what source you are listening to.

Select program type

Before tuning to RDS stations, you can select program type and let the unit search only for programs of the selected category.

- 1 Touch on FM band to select **FM1**, **FM2**, or **FM3**.
- 2 Touch **[PTY]**.
↳ List of available program type is displayed.



- 3 Touch **↓** or **↑** to display the next/previous screen.
- 4 Touch on the selected program type
↳ The unit starts to search stations of the selected program type.

Item	Program type	Description
1	News	News services
2	Affairs	Politics and current affairs
3	Info	Special information programs
4	Sport	Sports
5	Educate	Education and advanced training
6	Drama	Radio plays and literature
7	Culture	Culture, religion and society
8	Science	Science
9	Varied	Entertainment programs
10	Pop M	Pop music
11	Rock M	Rock music
12	Easy M	Light music
13	Light M	Light classical music
14	Classics	Classical music
15	Other M	Special music programs
16	Weather	Weather
17	Finance	Finance
18	Children	Children's programs
19	Social	Social Affairs
20	Religion	Religion

Item	Program type	Description
21	Phone In	Phone In
22	Travel	Travel
23	Leisure	Leisure
24	Jazz	Jazz Music
25	Country	Country Music
26	Nation M	National Music
27	Oldies	Oldies Music
28	Folk M	Folk Music
29	Document	Documentary
30	Test	Alarm Test
31	Alarm	Alarm

4 Play

Load discs

You can play video, audio or images stored on the following discs:

- DVD video, DVD-R, DVD-RW
- VCD
- Audio CD, CD-R, CD-RW



Note

- Ensure that the disc contains playable content.

- 1 Insert the disc into the disc slot with label side facing up.

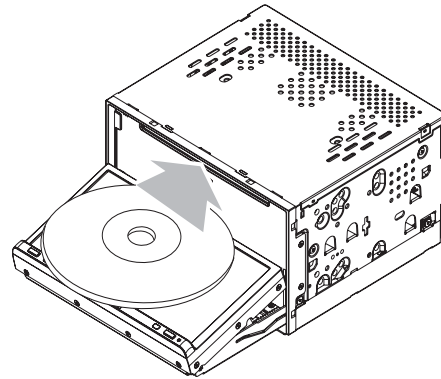

- ↳ Front panel closes automatically.
- ↳ Play starts automatically.
- ↳ To remove the disc, press the ▲ button.
 - ↳ When the disc is ejected, the unit switches to the previous source, if connected. Otherwise, the unit switches to **[Radio]** mode automatically.



Note

- Depends on where you bought the unit, you can play DVD discs with one of the following region codes:

Countries where you bought the unit	Supported DVD region code
China	
Asia Pacific, Taiwan, Korea	
Latin America	
Russia, India	

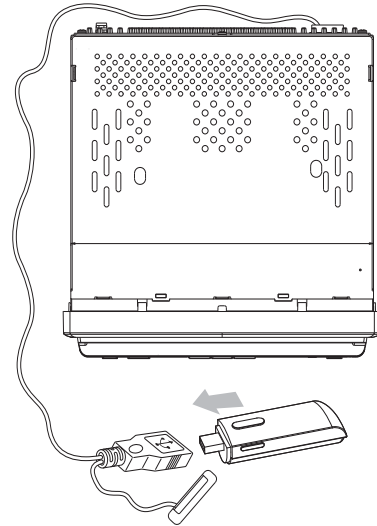

Connect USB device



Note

- Ensure that the device contains playable content.

- 1 Open the lid of USB socket.
- 2 Insert the USB to the USB socket.
↳ Play starts automatically.

Insert SD/MMC card



Note

- Ensure that the card contains playable content.

- 1 Press the ▲ button on the front panel.
↳ front panel opens.
- 2 Insert the card into the card slot until a click sound is heard.
↳ Play starts automatically.

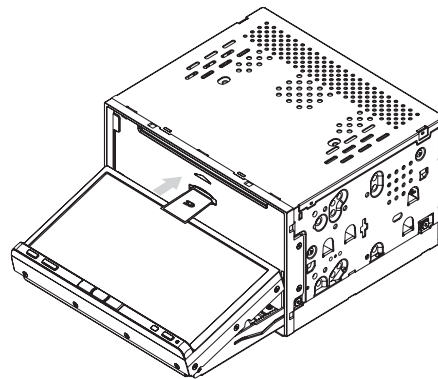

Remove the SD/MMC card

- 1 Press the ▲ button to open the front panel.
- 2 Press the card until a click sound is heard.
↳ The card is now disengaged.
- 3 Remove the card.

Play/Pause

- 1 Once a disc, USB or SD card is inserted, play starts automatically.
For DVD movie, if a menu appears, press to start play.
- 2 To pause, tap ⏸.
 - To resume play, tap ⏸ again.

Repeat

During play, you can select different repeat play modes.

For DVD/VCD video disc:

- 1 Touch anywhere on the screen to display the control bar.
- 2 Touch 🔄 repeatedly to select different repeat mode.

Tip

- If you can't find 🔄 in the control bar, touch 1/2 on the left lower of the screen to display the 2nd control bar.

For MP3/WMA/CD audio files:

- 1 Touch 🔄 on the upper line of the screen repeatedly to select different repeat mode.

Tip

- You can also press 🔄 on the remote control to select repeat play mode.

Note

- Repeat options available depend on the media type being played.

Skip/search

- 1 Tap ⏪ to return to playlist menu.
- 2 Tap one of below icons to select folder/file:
 - 📁 : To display all available audio folders/track.
 - 🖼️ : To display all available picture folders/files.
 - 📺 : To display all available video folders/files.
- 3 Tap ▲ or ▼ to select a folder/track.
- 4 Tap ▶ to start play.

Search within a title/folder

Search by step

- 1 Touch anywhere on the screen to display control bar.



- 2 Touch ⏪ or ⏩ to skip to the previous or next chapter/track.

Direct search

- 1 Touch anywhere on the screen to display control bar.

- 2 Touch **1/2** on the left lower corner of the screen.
↳ The second control bar displays.



- 3 Touch **⋮**.
↳ The search screen is displayed.



- 4 Touch **⋮** repeatedly to choose searching by chapter/title/time.
 - The search options available depends on the media source type.
- 5 Touch the numbers to enter chapter/title/time number.
 - To clear the previous input, touch **←**.
 - To clear all input, touch **✕**.
- 6 Touch **✓** after finished entering.
↳ Play starts from the selected section.

Random play

You can play audio tracks/files or VCD videos in random order.

- 1 During play, touch **⌘** repeatedly to turn random play on or off.



Tip

- You can also press **⌘** on the remote control to select random play mode.

Select audio language

For video discs that contain two or more audio channels.

- 1 During play, touch anywhere on the screen to display control bar.
- 2 Touch **1/2** on the left lower of the screen to display the 2nd control bar.
- 3 Touch **⌘** repeatedly.
↳ The audio channel information is displayed on the top of the screen.

Select subtitle language

For DVD or DivX discs that contain two or more subtitle languages.

- 1 During play, touch anywhere on the screen to display control bar.
- 2 Touch **1/2** to display the 2nd control bar.
- 3 Touch **⌘** repeatedly to select a language.
↳ The selected language is displayed.



Tip

- You may also press **DVD TITLE** on the remote control repeatedly to select subtitle language.

Rotate pictures





- 1 When you view pictures, touch anywhere on the screen to display control bar.



- 2 Touch **⌘** repeatedly to rotate the picture.

Zoom

You can zoom in pictures for a close view.

- 1 During viewing pictures, touch anywhere on the screen to display menu bar.
- 2 Touch  repeatedly to zoom in the picture.
- 3 Touch , ,  or  to pan through the enlarged picture.



5 Play with Bluetooth device

You can make or receive phone calls with Bluetooth-enabled phones through the unit. You can also listen to music from a Bluetooth-enabled device.

Pair the Bluetooth-enabled devices



To connect your Bluetooth device to the unit, you need to pair the device to the unit. Pairing needs only to be done once. You can pair up to eight devices.

Note

- The operational range between this unit and a Bluetooth device is approximately 5 meters.
- Before you connect a Bluetooth device to this unit, familiarize yourself with the Bluetooth capabilities of the device.
- Compatibility with all Bluetooth devices is not guaranteed.
- Any obstacle between this unit and a Bluetooth device can reduce the operational range.
- Keep this unit away from any other electronic device that may cause interference.

- 1 Turn on the Bluetooth function on your device.
- 2 Search for other Bluetooth device with your device.
- 3 Select "CED1700" in the pairing list.
- 4 Enter default password "0000".
 - ↳ If pairing succeeds, the dial screen displays.

Disconnect Bluetooth devices

- 1 To disconnect one device, touch  (red).
↳  (green) is displayed.

Re-connect Bluetooth devices

- 1 Touch  on top of the screen.
↳ The bluetooth/paired device screen displays.



- 2 Touch on one device that you want to re-connect.
- 3 Touch  (green).
↳ Start to re-connect the selected device.

Tip

- The device will also be disconnected when the device is moved beyond the operational range.
- If you want to reconnect the device to the unit, place it within the operational range.
- If you do not want to reconnect the device to the unit automatically, under Bluetooth mode, touch , and then touch option after **[Auto connect]** repeatedly until **[Off]** displays. For details, see the "Adjust Bluetooth settings" section.





Make a call

You can make phone call with the unit under any mode.

Note

- Make sure the phone is connected to the unit via Bluetooth.

- 1 Touch  on top of the screen.
↳ The dial screen displays.

- 2 Touch number icons directly to input phone number.
 - Touch  to delete last input
 - Touch  to access Bluetooth option menu.
 - Touch  to go back to previous screen.
- 3 After the phone number entered, touch .
↳ The unit starts dialing.

Receive call

By default, all incoming calls are received automatically.

- 1 If there is incoming call, **[Incoming call...]** flashes on the screen. Speak into the Bluetooth microphone.

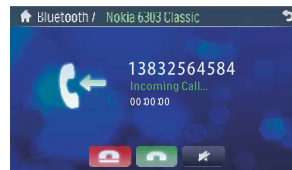

- 2 When conversation ends, tap  (red) to terminate the call.

Tip

- You can select to receive calls manually by set **[Auto answer]** to **[Off]** status.

Switch phone call to the mobile

If you do not want your passenger to hear your incoming call, you can switch the call to the mobile.

- 1 During talking, tap .
↳ The voice is transferred from the unit's loudspeaker to the mobile phone.

Listen to music from Bluetooth device

If the connected Bluetooth device supports Advanced Audio Distribution Profile (A2DP), you can listen to the music stored on the device through the unit. If the device also supports Audio Video Remote Control Profile (AVRCP) profile, you can use the control on the unit or its remote control to play music stored on the device.

- 1 Pair the phone with the unit.
- 2 Tap  to return to home menu.
- 3 Tap **[Bluetooth]**.
↳ The Bluetooth menu is displayed.
- 4 Start play music via device.

If your device support AVRCP.

- 1 Tap .

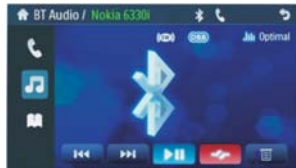

- 2 Tap  to start play.

Note

- Check the manual of your Bluetooth device and see whether it allows you to have full Bluetooth controls.

Adjust Bluetooth settings

You can change below Bluetooth settings:

- **[Auto answer]**: to turn on or off "Auto answer" function
- **[Auto connect]**: to turn on or off "Auto connect" function
- **[Paired Device]**: display paired device



- 1 In Bluetooth menu, touch .
↳ The option menu is displayed.
- 2 Touch an option to change the setting.

6 Adjust sound

Adjust volume

- 1 Press +/- on the front panel to increase/decrease volume.

Mute

- 1 During play, press /MUTE on the front panel.
 - To turn the sound back on, press /MUTE again.



Tip

- You can also turn off sound by touching  on the screen.







Select preset equalizer

You can select preset equalizer:

- [User]
- [Techno]
- [Rock]
- [Classic]
- [Jazz]
- [Optimal]
- [Flat]
- [Pop]



- 1 During audio/video play, touch  on the screen.
 - ↳ The current Equalizer setting is displayed.





- 2 Touch  or  to select an EQ.
- 3 Touch  or  to adjust below settings:
 - [Bass] bass range: -15 to +15.
 - [Mid] middle range: -15 to +15.
 - [Treb] treble range: -15 to +15.
 - [LPH] low pass filter range: 60Hz, 80Hz, 100Hz, 200Hz.
 - [MPF] middle pass filter range: 500Hz, 1kHz, 1.5kHz, 2.5kHz.
 - [HPF] high pass filter range: 10kHz, 12.5kHz, 15kHz, 17.5kHz.
- 4 Touch  to restore the above settings into default settings.
- 5 Touch  to exit.

Adjust fader/balance

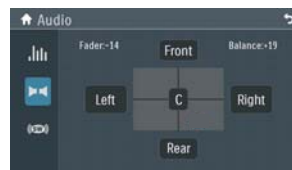

You can also adjust the front and rear speaker balance, the left and right speaker balance settings.

- 1 During play touch  on the screen.
- 2 Touch 
 - ↳ Screen below displays:



- 3 Touch [Front], [Rear], [Left], [Right] or [C] (center) to adjust fader/balance value.
 - Fader range: +16 to -16.
 - Balance range: -16 to +16.
- 4 Touch  to exit.



Adjust Subwoofer value

- 1 During play, touch  on the screen.
- 2 Touch .
↳ Screen below displays:



- 3 Touch [On] to turn on the subwoofer.
- 4 Touch ▲/▼ to adjust value of subwoofer level and subwoofer low pass filter (LPF).
- 5 Touch ↶ to exit.

Set Dynamic Bass Boost (DBB)

- 1 Tap  to toggle between the settings.
 - [DBB] on: The  icon is illuminated.
 - [DBB] off (default): The  icon is gray.

7 Adjust settings

Adjust general settings

- 1 Touch  to display home menu.
- 2 Touch [Settings].
↳ Setting menu displays.
- 3 Touch ▲ or ▼ to access 2nd page.
- 4 Touch on an option to display/select the option.

General settings	Options	Description
[Dimmer]	[High]/[Middle]/[Low]	Turn on the screen dim high/middle/low.
[Beep]	[On]	Turn on the beep sound. Each time you press a button/icon, the unit beeps.
	[Off]	Turn off the beep sound.
[Language]	[English], [简体中文], [繁体中文], [Portugués], [Español]	Select the on screen display language.
[External Navi]	[Off]/[On]	Turn the external GPS off/on.
[Tuner Area]	[USA]/[Latin]/[Asia]/[Mid-East]/[Europe]/[Russia]	Select the suitable country area of the radio.
[Date]		Set the system date.
[Clock Mode]	[12Hr]/[24Hr]	Select time format.
[Set Time]		Adjust clock of the unit.

General settings	Options	Description
[Parking wire]	[Off]	Turn off parking wire.
	[On]	Turn on parking wire.
[Information]	[Enter]	Display the information on the unit.
[Calibration]	[Start]	Calibrate the touch screen.

- 5 Touch ↩ to exit.

Adjust Bluetooth settings

- 1 Touch [Bluetooth] on the home menu.
↳ Bluetooth menu displays.
- 2 Touch  to display Bluetooth option menu.
- 3 Touch on the options to select:

Bluetooth settings	Options	Description
[Auto answer]	[On]	Answer paired phone call automatically.
	[Off]	Answer phone call manually.
[Auto connect]	[On]	If the pre-paired device is within the effective range, the unit re-connects to pre-paired device automatically.
	[Off]	Need to re-connect manually.
[Paired Device]		Touch to display paired device(s).

- 4 Touch ↩ to exit.

8 Others

Listen to other devices

You can connect an external audio/video device to the unit.

- 1 Connect the car audio to the device through the **REAR OUT L/R** connector (see "Connect wires" section)
- 2 Touch  to display the home menu.
- 3 Touch [AV-IN].
- 4 Operated the connected the device (see the instructions manual of the device).

Reset

When the unit hangs up, you can reset it.

- 1 Press reset button on the lower right of the front panel with a ball-point pen or similar tool.

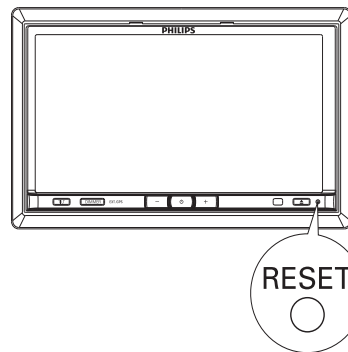

Tip

- When the unit is reset, all the settings remain unchanged.

Remove the unit

To repair, replace fuse, or replace the unit with another car audio, remove it from the dashboard.

- 1 Take off the trim plate.
- 2 Pull the unit out from the dashboard.

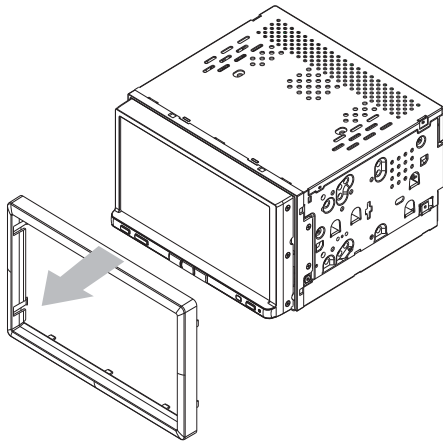

Replace fuse

If there is no power, the fuse may be damaged and need to be replaced.

- 1 Take out the unit from dashboard.
- 2 Check the electric connection.
- 3 Buy a fuse that matches the voltage of the damaged fuse (15A)
- 4 Replace the fuse.

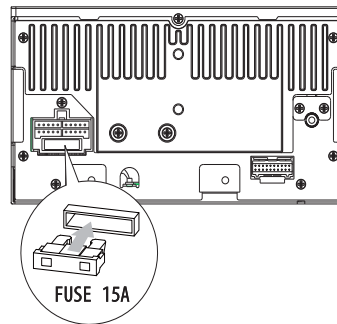

If the fuse gets damaged immediately after it has been replaced, there may be an internal malfunction. In such case, consult your Philips dealer.

9 Product information



Note

- Product information is subject to change without prior notice.

General

Power supply	12 V DC (11 V - 16 V), negative ground
Fuse	15 A
Suitable speaker impedance	4 - 8 Ω
Maximum power output	50 W \times 4 channels
Continuous power output	24 W \times 4 channels (4 Ω 10% T.H.D.)
Pre-Amp output voltage	2.0 V (CD play mode; 1 kHz, 0 dB, 10 k Ω load)
Subwoofer output voltage	2.0 V (CD play mode, 61 Hz, 0 dB, 10 k Ω load)
Aux-in level	\geq 500 mV
Dimensions (W \times H \times D)	178 \times 100 \times 185.4 mm
Weight (main unit)	2.4 kg

Disc player

System	DVD / CD audio / MP3 system
Frequency response	20 Hz - 20k Hz
Signal/noise ratio	>75dB
Total harmonic distortion	Less than 1%
Channel separation	>55dB
Video signal format	NTSC only
Video output	1 +/- 0.2V

Tuner

Frequency range - FM	87.5 - 108.0 MHz (Europe)
Frequency range - AM (MW)	522 - 1620 KHz (Europe)
Usable sensitivity - FM	5 μ V
Usable sensitivity - AM (MW)	50 μ V

LCD

Screen size	6.95 inches (16:9)
Display resolution	800 \times 480 dots
Contrast ratio	300
Brightness	350 cd/m ²

Bluetooth

Communication system	Bluetooth Standard version 2.1
Output	Bluetooth Standard Power Class 2
Maximum communication range	Line of sight approx. 8m
Frequency band	2.4 GHz band (2.4000 GHz - 2.4835 GHz)
Compatible Bluetooth profiles	Hands-Free Profile (HFP) Handset Profile (HSP) Advanced Audio Distribution Profile (A2DP) Audio Video Remote Control Profile (AVRCP)
Supported codecs	
Receive	SBC (Sub Band Codec)
Transmit	SBC (Sub Band Codec)

Compatible USB devices:

- USB flash memory (USB 2.0 or USB1.1)
- USB flash players (USB 2.0 or USB1.1)
- memory cards (SD / SDHC)

Supported formats:

- USB or memory file format: FAT16, FAT32
- MP3 bit rate (data rate): 32-320 Kbps and variable bit rate
- WMA v9 or earlier
- Directory nesting up to a maximum of 8 levels
- Number of albums/ folders: maximum 99
- Number of tracks/titles: maximum 999
- ID3 tag v2.0 to v2.4
- File name in Unicode UTF8 (maximum length: 128 bytes)

Supported MP3 disc format:

- ISO9660, Joliet
- Maximum title number: 512 (depending on file name length)
- Maximum album number: 255
- Supported sampling frequencies: 32 kHz, 44.1 kHz, 48 kHz
- Supported Bit-rates: 32-320 Kbps and variable bit rate

Supported video formats:

- DVD
- Divx Home theater
- MP4
- Xvid



Note

- To ensure a better playback, recommend that file image size is not higher than 640X480, frame rate is 20 fps, data rate is not higher than 500kbps

10 Troubleshooting



Warning

- Never remove the casing of this apparatus.

To keep the warranty valid, never try to repair the system yourself.

If you encounter problems when using this apparatus, check the following points before requesting service. If the problem remains unsolved, go to the Philips web site (www.philips.com/welcome). When you contact Philips, ensure that the apparatus is nearby and the model number and serial number are available.

No power

- Car engine has not been started. Start the car engine.
- Connections is incorrect.
- Fuse has been damaged. Replace fuse.

No sound

- Volume is too low. Adjust volume.
- Speaker connections is incorrect.

No response to the remote control

- Ensure that the path between the remote control and the unit is clear from obstacles.
- From a close distance, point the remote control directly at the unit.
- Switch **F/R** to correct position (**F** for front control and **R** for rear control).
- The function does not work. Refer to the instructions.
- Replace the remote control battery.

Disc does not play

- Disc is upside down. Ensure the printed side is upwards.
- Disc is dirty. Clean the disc with a clean, soft, lint-free cloth. Wipe the disc outwards from the center.
- Disc is defective. Try another disc.
- incompatible disc is used. Try another disc.

- Disc rating exceeds the restrict setting. Change the rating settings to lower one.
- Disc region code is not compatible with the unit. Use disc with proper region code.

No image

- Parking brake wire connection is incorrect. Check the parking wiring.

Image flashes or distorted

- Video DVD settings do not match with the DVD. Adjust video DVD settings.
- Video connection is improper. Check the connections.

Noise in broadcasts.

- Signals are too weak. Select other stations with stronger signals.
- Check the connection of the car antenna.
- Change broadcast from stereo to mono.

Preset stations lost.

- Battery cable is not correctly connected. Connect the battery cable to the terminal that is always live.

Fuse is broken

- The Fuse type is incorrect. Replace it with a 15A fuse.
- Speaker wire or power wire is grounded. Check the connections.

Display show ERR-12

- USB/SD data error. Check the USB device or SD card.

About Bluetooth device

Music playback is unavailable on the system even after successful Bluetooth connection.

- The device cannot be used with the system to play music.

The audio quality is poor after connection with a Bluetooth-enabled device.

- The Bluetooth reception is poor. Move the device closer to the system or remove any obstacle between the device and the system.

Cannot connect with the system.

- The device does not support the profiles required for the system.
- The Bluetooth function of the device is not enabled. Refer to the user manual of the device for how to enable the function.
- The system is not in the pairing mode.
- The system is already connected with another Bluetooth-enabled device. Disconnect that device or all other connected devices and then try again.

The paired mobile phone connects and disconnects constantly.

- The Bluetooth reception is poor. Move the mobile phone closer to the system or remove any obstacle between the mobile phone and the system.
- Some mobile phones may connect and disconnect constantly when you make or end calls. This does not indicate any malfunction of the system.
- For some mobile phones, the Bluetooth connection may be deactivated automatically as a power-saving feature. This does not indicate any malfunction of the system.

11 Glossary

B

Bite rate

The max data transfer through the USB port.

Bluetooth

Bluetooth® is a short-rang wireless protocol that is meant to allow mobile devices to share information and applications without the worry of cables or interface incompatibilities. The name refers to a Viking King who unified Denmark. Operate at 2.4GHz. For more information, see www.bluetooth.com.

M

MP3

A file format with a sound data compression system. MP3 is the abbreviation of Motion Picture Experts Group 1 (or MPEG-1) Audio Layer 3. With the MP3 format, one CD-R or CD-RW can contain about 10 times more data than a regular CD.

R

Region code

A system that allows discs to be played only in the region designated. This unit only plays discs that have compatible region codes. You can find the region code of your unit on the product label. Some discs are compatible with more than one region (or ALL regions.)

S

SD

Secure Digital. A type of memory card with a flash memory.

SDHC

Secure Digital High Capacity (SDHC) is a type of flash memory card based on the SDA 2.00 specification. The SDA 2.00 specification enables SD cards to reach higher capacities from 4GB to 32GB, and growing.

W

WMA (Windows Media Audio)

An audio format owned by Microsoft, is a part of Microsoft Windows Media technology. Includes Microsoft Digital Rights Management tools, Windows Media Video encoding technology, and Windows Media Audio encoding technology.



© 2011 Koninklijke Philips Electronics N.V.
All rights reserved.
CED1700_IFU_51_V2.0

