

Register your product and get support at
www.philips.com/welcome

FWM663



EN User manual

PHILIPS

Content

1 Important	36
Safety	36
Notice	37

2 Your Mini Hi-Fi System	38
Introduction	38
What's in the box	38
Overview of the main unit	39
Overview of the remote control	41

3 Connect	42
Connect FM antenna	42
Connect AM antenna	42
Connect speakers	43
Connect power	43

4 Get started	44
Prepare the remote control	44
Auto install radio stations	44
Set clock	44
Turn on	45

5 Play	45
Play disc	45
Play from a USB device	46
Play from an SD card	46
Play from an external device	47

6 Play options	47
Repeat and random play	47
Program tracks	47
Display play information	47

7 Adjust volume level and sound effect	48
Adjust volume level	48
Mute sound	48
Boost loudness	48
Select a preset sound effect	48
Enhance bass	48

Virtual surround	48
Customize sound for room acoustics	49

8 Listen to radio	49
Tune to a radio station	49
Program radio stations automatically	49
Program radio stations manually	50
Select a preset radio station	50

9 USB/SD record	50
Record to a USB/SD device	50
Record CDDA contents to USB/SD device with high speed	51
Record CDDA contents to a USB/SD device at any playback time	51
Schedule radio-to-USB/SD record	51

10 Other features	52
Set the alarm timer	52
Set the sleep timer	53
Listen to an external device	53
Delete from a USB/SD device	53
Copy files between SD and USB device	53
Karaoke	54

11 Product information	54
Specifications	54
USB playability information	55
Supported MP3 disc formats	56
Maintenance	56

1 Important

Safety

- ① Read these instructions.
- ② Keep these instructions.
- ③ Heed all warnings.
- ④ Follow all instructions.
- ⑤ Do not use this apparatus near water.
- ⑥ Clean only with dry cloth.
- ⑦ Do not block any ventilation openings. Install in accordance with the manufacturer's instructions.
- ⑧ Do not install near any heat sources such as radiators, heat registers, stoves, or other apparatus (including amplifiers) that produce heat.
- ⑨ Protect the power cord from being walked on or pinched, particularly at plugs, convenience receptacles, and the point where they exit from the apparatus.
- ⑩ Only use attachments/accessories specified by the manufacturer.
- ⑪ Use only with the cart, stand, tripod, bracket, or table specified by the manufacturer or sold with the apparatus. When a cart is used, use caution when moving the cart/apparatus combination to avoid injury from tip-over.
- ⑫ Unplug this apparatus during lightning storms or when unused for long periods of time.
- ⑬ Refer all servicing to qualified service personnel. Servicing is required when the apparatus has been damaged in any way, such as power-supply cord or plug is damaged, liquid has been spilled or objects have fallen into the apparatus, the apparatus has been exposed to rain or moisture, does not operate normally, or has been dropped.
- ⑭ Battery usage CAUTION – To prevent battery leakage which may result in bodily injury, property damage, or damage to the unit:
 - Install all batteries correctly, + and - as marked on the unit.
 - Do not mix batteries (old and new or carbon and alkaline, etc.).
 - Remove batteries when the unit is not used for a long time.
- ⑮ Apparatus shall not be exposed to dripping or splashing.
- ⑯ Do not place any sources of danger on the apparatus (e.g. liquid filled objects, lighted candles).
- ⑰ This product may contain lead and mercury. Disposal of these materials may be regulated due to environmental considerations. For disposal or recycling information, please contact your local authorities or the Electronic Industries Alliance: www.eiae.org.
- ⑱ Where the MAINS plug or an appliance coupler is used as the disconnect device, the disconnect device shall remain readily operable.



Warning

- Never remove the casing of this apparatus.
- Never lubricate any part of this apparatus.
- Never place this apparatus on other electrical equipment.
- Keep this apparatus away from direct sunlight, naked flames or heat.
- Never look into the laser beam inside this apparatus.
- Ensure that you always have easy access to the power cord, plug or adaptor to disconnect this apparatus from the power.

Caution

- Use of controls or adjustments or performance of procedures other than herein may result in hazardous radiation exposure or other unsafe operation.

packaging materials, exhausted batteries and old equipment.



Windows Media and the Windows logo are trademarks, or registered trademarks of Microsoft Corporation in the United States and/or other countries.

This apparatus includes this label:

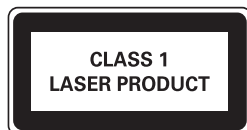

Notice

Any changes or modifications made to this device that are not expressly approved by Philips Consumer Lifestyle may void the user's authority to operate the equipment.

 **Be responsible**
Respect copyrights

The making of unauthorized copies of copy-protected material, including computer programs, files, broadcasts and sound recordings, may be an infringement of copyrights and constitute a criminal offence. This equipment should not be used for such purposes.

Environmental information

All unnecessary packaging has been omitted. We have tried to make the packaging easy to separate into three materials: cardboard (box), polystyrene foam (buffer) and polyethylene (bags, protective foam sheet.)

Your system consists of materials which can be recycled and reused if disassembled by a specialized company. Please observe the local regulations regarding the disposal of

2 Your Mini Hi-Fi System

Congratulations on your purchase, and welcome to Philips! To fully benefit from the support that Philips offers, register your product at www.Philips.com/welcome.

Introduction

With this unit, you can enjoy audio from discs, USB devices, iPod players, external devices, or radio stations.

For your convenience, you can load up to three discs at once.

To enrich sound, this unit offers you these sound effects:

- MAX sound for instant power boost
- Digital Sound Control (DSC)
- Dynamic Bass Boost (DBB)
- Incredible surround (IS)
- Virtual Ambience-based Control (VAC)

The unit supports the following media formats:



What's in the box

Check and identify the contents of your package:

- Main unit x 1
- AC power cable x 1
- Front speakers x 2
- Subwoofer x 1
- Remote control with 2 AAA batteries
- FM wire antenna x 1
- AM loop antenna x 1
- MP3 link cable x 1
- Quick start guide x 1
- User manual x 1

Overview of the main unit

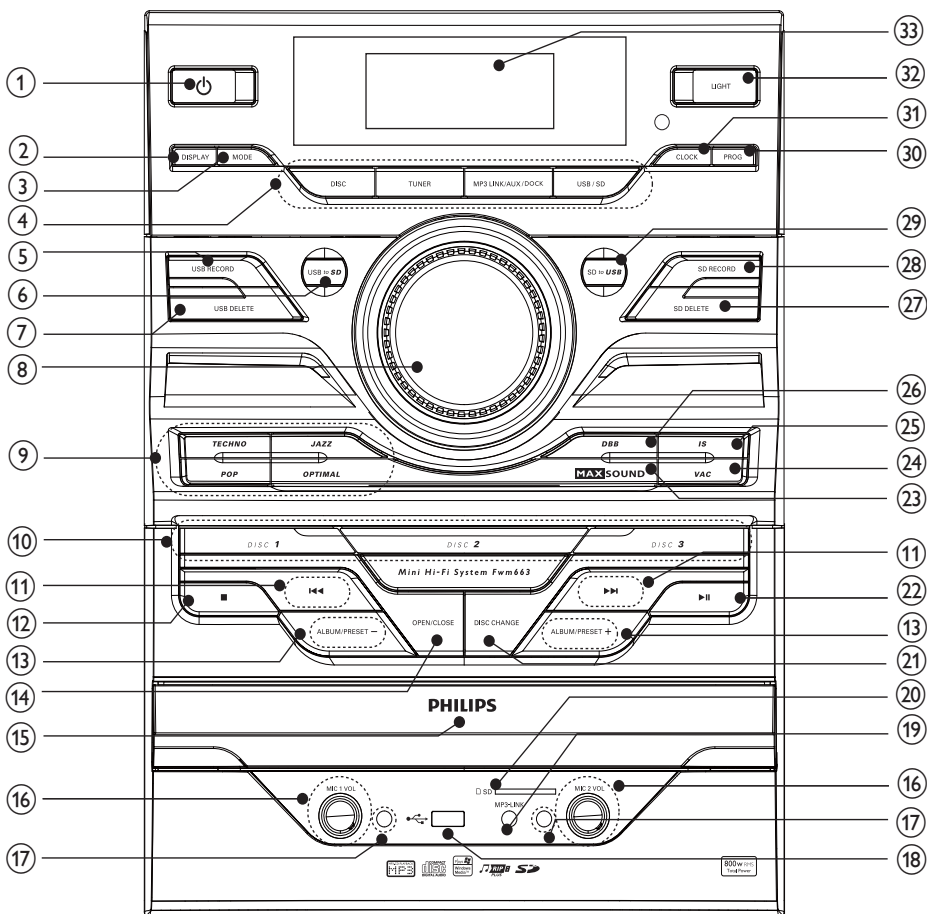

- | | |
|---|---|
| <p>① ⏻</p> <ul style="list-style-type: none"> Turn on the unit or switch to standby mode. <p>② DISPLAY</p> <ul style="list-style-type: none"> Select display information. <p>③ MODE</p> <ul style="list-style-type: none"> Select repeat play or random play. | <p>④ Source selection keys</p> <ul style="list-style-type: none"> Select a source. <p>⑤ USB RECORD</p> <ul style="list-style-type: none"> Record to a USB device. <p>⑥ USB to SD</p> <ul style="list-style-type: none"> Copy audio files from a USB device to an SD card. |
|---|---|

- ⑦ **USB DELETE**
 - Delete audio files stored on a USB device.
- ⑧ **VOLUME**
 - Adjust volume.
- ⑨ **DSC**
 - Select a preset sound equalizer setting.
- ⑩ **DISC 1/2/3**
 - Select a disc.
- ⑪ **⏮️/⏭️**
 - Skip to the previous/next track.
 - Search within a track/disc/USB/SD device/DOCK.
 - Tune to a radio station.
 - Adjust time.
- ⑫ **■**
 - Stop play or erase a program.
- ⑬ **ALBUM/PRESET+/-**
 - Skip to the previous/next album.
 - Select a preset radio station.
 - Adjust time.
 - Select 12 hour or 24 hour format.
- ⑭ **OPEN/CLOSE**
 - Open or close the disc compartment.
- ⑮ **Disc compartment door**
- ⑯ **MIC VOL**
 - Adjust microphone volume.
- ⑰ **Microphone port**
 - Jack for a microphone.
- ⑱ **🔌**
 - Jack for a USB mass storage device.
- ⑲ **MP3 LINK**
 - Audio input jack (3.5mm) for an external audio device.
- ⑳ **SD card slot**
- ㉑ **DISC CHANGE**
 - Change a disc.
- ㉒ **▶️||**
 - Start or pause play.
- ㉓ **MAX SOUND**
 - Turn on or off instant power boost for sound.
- ㉔ **VAC**
 - Select an ambiance-based equalizer setting.
- ㉕ **IS**
 - Turn on or off incredible surround.
- ㉖ **DBB**
 - Turn on or off dynamic bass enhancement.
- ㉗ **SD DELETE**
 - Delete audio files stored on an SD device.
- ㉘ **SD RECORD**
 - Record to an SD card.
- ㉙ **SD to USB**
 - Copy audio files from an SD card to a USB device.
- ㉚ **PROG**
 - Program tracks.
 - Program radio stations.
- ㉛ **CLOCK**
 - Set the clock/View the clock.
- ㉜ **LIGHT**
 - Turn on or off the lighting effect.
- ㉝ **Display panel**
 - Show status.

Overview of the remote control

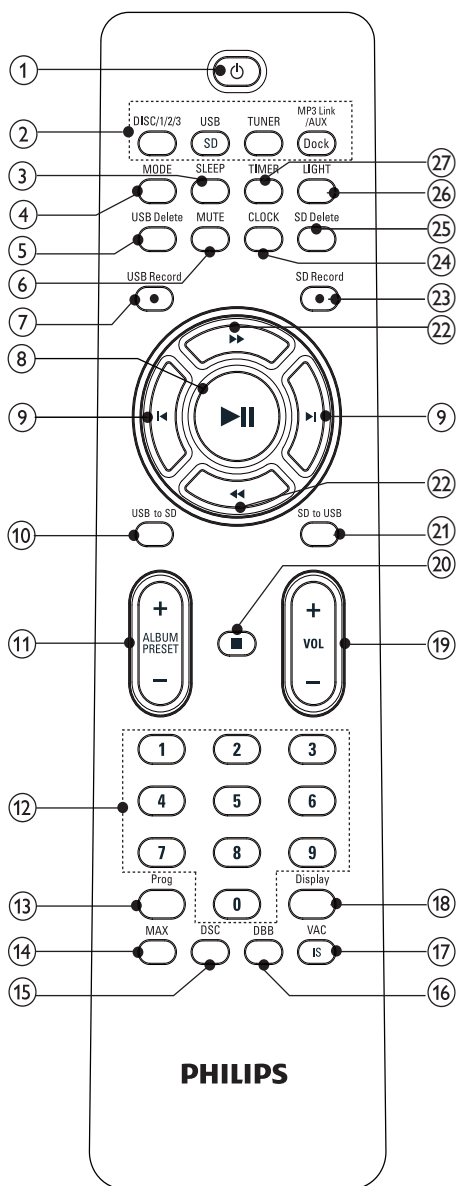

- ① **Power**
 - Turn on the unit or switch to standby mode.
- ② **Source selection keys**
 - Select a source.
- ③ **SLEEP**
 - Set the sleep timer.
- ④ **MODE**
 - Select repeat play or random play.
- ⑤ **USB DELETE**
 - Delete audio files stored on a USB device.
- ⑥ **MUTE**
 - Mute volume.
- ⑦ **USB RECORD**
 - Record to a USB device.
- ⑧ **▶▶**
 - Start or pause play.
- ⑨ **◀◀**
 - Skip to the previous/next track.
- ⑩ **USB to SD**
 - Copy audio files from a USB device to an SD card.
- ⑪ **ALBUM/PRESET+/-**
 - Skip to the previous/next album.
 - Select a preset radio station.
 - Adjust time.
 - Select 12 hour or 24 hour format.
- ⑫ **Numeric keypad**
 - Select a track from a disc directly.
- ⑬ **PROG**
 - Program tracks.
 - Program radio stations.
- ⑭ **MAX SOUND**
 - Turn on or off instant power boost for sound.
- ⑮ **DSC**
 - Select a preset sound equalizer setting.

- ⑩ **DBB**
 - Turn on or off dynamic bass enhancement.
- ⑪ **VAC/IS**
 - Select an ambiance-based equalizer setting.
 - Turn on or off incredible surround.
- ⑫ **DISPLAY**
 - Select display information.
- ⑬ **VOL +/-**
 - Adjust volume.
- ⑭ **■**
 - Stop play or erase a program.
- ⑮ **SD to USB**
 - Copy audio files from an SD card to a USB device.
- ⑯ **⏮/⏭**
 - Skip to the previous/next track.
 - Search within a track/disc/USB/SD device/DOCK.
 - Tune to a radio station.
 - Adjust time.
- ⑰ **SD RECORD**
 - Record to an SD card.
- ⑱ **CLOCK**
 - Set the clock/View the clock.
- ⑲ **SD DELETE**
 - Delete audio files stored on an SD device.
- ⑳ **LIGHT**
 - Turn on or off the lighting effect.
- ㉑ **TIMER**
 - Set the alarm timer.

3 Connect

Connect FM antenna

- 1 Connect the supplied FM antenna to the FM jack on the back of the main unit.

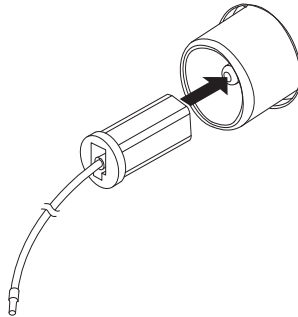

Connect AM antenna

- 1 Assemble the AM loop antenna.

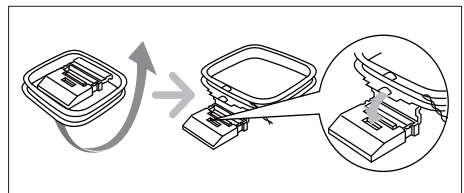

- 2 Connect the AM loop antenna to the AM jack on the back of the main unit.

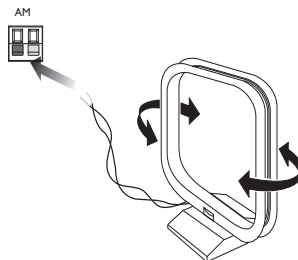

Connect speakers

Note

- For optimal sound, use the supplied speakers only.
- Connect only speakers with impedance that is the same or higher than the supplied speakers. Refer to the Specifications section of this manual.

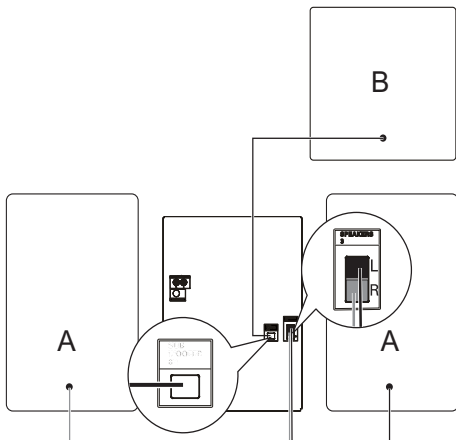

A: Speakers; B: Subwoofer

Connect the speakers

- 1 Find "SPEAKERS" sockets on the main unit.
- 2 Insert the black connector of the right speaker wire to "R", and the black connector of the left speaker wire to "L".

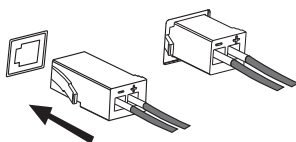

Connect the subwoofer

- 3 Insert the blue connector of the subwoofer wire to "SUB WOOFER" socket.

Connect power

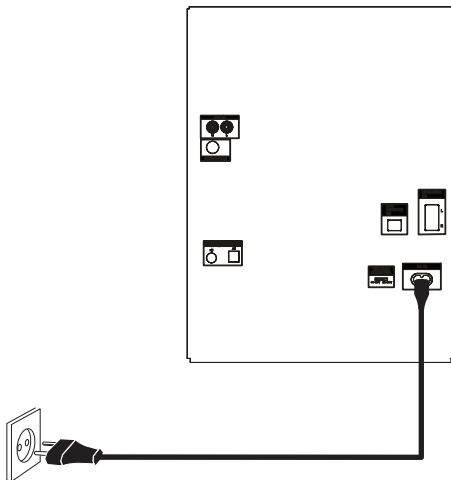

! Caution

- Risk of product damage! Ensure that the power supply voltage corresponds to the voltage set on the voltage selector on the back of the unit.
- Ensure that the power supply socket used can support at least 10A current loading.
- Before connecting the AC power cord, ensure that you have completed all other connections.

Note

- The type plate is located on the back of the main unit.

- 1 Connect the AC power cable to:
 - the main unit.
 - the wall socket.

4 Get started

! Caution

- Use of controls or adjustments or performance of procedures other than herein may result in hazardous radiation exposure or other unsafe operation.

Always follow the instructions in this chapter in sequence.

If you contact Philips, you will be asked for the model and serial number of this apparatus. The model number and serial number are on the back of the apparatus. Write the numbers here:

Model No. _____

Serial No. _____

Prepare the remote control

≡ Note

- Risk of explosion! Keep batteries away from heat, sunshine or fire. Never discard batteries in fire.

To replace the remote control battery:

- 1 Open the battery compartment.
- 2 Insert two AAA batteries with correct polarity (+/-) as indicated.
- 3 Close the battery compartment.

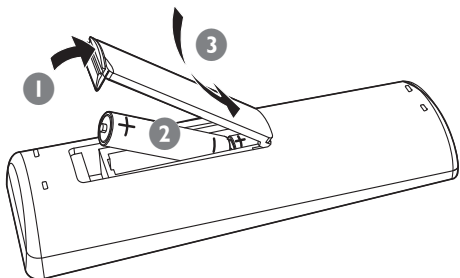

≡ Note

- If you are not going to use the remote control for a long time, remove the batteries.
- Do not use old and new or different types of batteries in combination.
- Batteries contain chemical substances, so they should be disposed of properly.

Auto install radio stations

When you connect power and no radio stations are stored, the unit automatically begins to store radio stations.

- 1 Connect the unit to the power supply.
 - ↳ [AUTO INSTALL - PRESS PLAY] (auto install - press the PLAY button) is displayed.
- 2 Press **▶||** on the main unit to start installation.
 - ↳ [AUTO] (auto) is displayed.
 - ↳ The unit automatically stores radio stations with sufficient signal strength.
 - ↳ When all the available radio stations are stored, the first preset radio station is broadcast automatically.

Set clock

- 1 In the standby mode, press **CLOCK** to activate the clock setting mode.
 - ↳ The 12 hour or 24 hour format is displayed.
- 2 Press **ALBUM/PRESET+/-** repeatedly to select 12 hour or 24 hour format.
- 3 Press **CLOCK** to confirm.
 - ↳ The clock digits are displayed and begin to blink.
- 4 Press **ALBUM/PRESET+/-** to set the hour.
- 5 Press **◀▶** to set the minute.
- 6 Press **CLOCK** to confirm.

Tip

- To view the clock during play, press **CLOCK**.

Turn on

- 1 Press ϕ .
 - ↳ The unit switches to the last selected source.

Switch to standby

- 1 Press ϕ to switch the unit to standby mode.
 - ↳ The backlight on the display panel turns off.
 - ↳ The clock (if set) appears on the display panel.

5 Play

Play disc

- 1 Press **CD 1/2/3** to select the disc source.
- 2 Press **OPEN/CLOSE** on the main unit to open the disc compartment.
- 3 Load up to two discs on the disc trays, with the printed side facing up.
 - To load the third disc, press **DISC CHANGE** on the main unit to rotate to the disc tray.

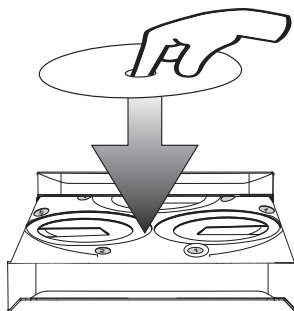

- 4 Press **OPEN/CLOSE** on the main unit to close the disc compartment.
 - ↳ Play starts automatically.
 - To select a disc, press **DISC 1/2/3**.
 - To pause/resume play, press **▶||**.
 - To stop play, press **■**.
 - To select another track, press **◀▶** or press a numeric button.
 - To select an album, press **ALBUM/PRESET+/-**.
 - To search within a track, press and hold **◀▶▶**, and then release to resume normal play.

Play from a USB device

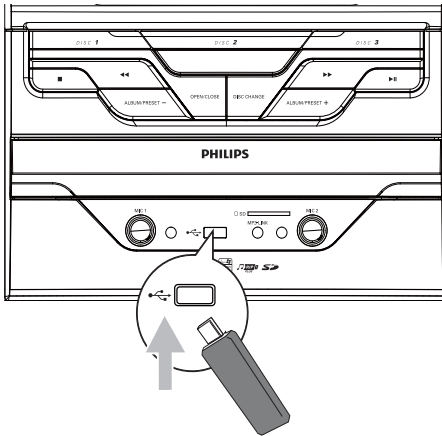

Note

- Ensure that the USB device contains playable audio contents for supported formats. (see 'USB playability information' on page 29)

- 1 Insert the USB plug of the device into the  socket.
- 2 Press **USB/SD** to select the USB source.
- 3 Press **ALBUM/PRESET+/-** to select a folder.
- 4 Press **◀▶** to select an audio file.
- 5 Press **▶||** to start play.
 - To pause/resume play, press **▶||**.
 - To stop play, press **■**.
 - To search within an audio file, press and hold **◀▶**, then release to resume normal play.

Play from an SD card

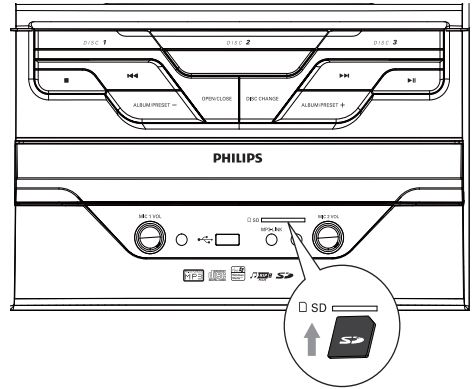

Note

- Ensure that the SD card contains playable audio contents for supported formats. (see 'USB playability information' on page 29)

- 1 Insert the SD card into the SD card slot.
- 2 Press **USB/SD** to select the SD source.
- 3 Press **ALBUM/PRESET+/-** to select a folder.
- 4 Press **◀▶** to select an audio file.
- 5 Press **▶||** to start play.
 - To pause/resume play, press **▶||**.
 - To stop play, press **■**.
 - To search within an audio file, press and hold **◀▶**, then release to resume normal play.





Play from an external device

You can also listen to an external audio device through this unit.

- 1 Press **MP3-LINK** to select the MP3 link source.
- 2 Connect the supplied MP3 link cable to:
 - the **MP3 LINK** jack (3.5mm) on the unit.
 - the headphone jack on an external device.
- 3 Start to play the device (see the device user manual).

6 Play options

Repeat and random play

- 1 Press **MODE** repeatedly to select:
 - : the current track is played repeatedly.
 - : all tracks are played repeatedly.
 - : all tracks are played randomly and repeatedly.
 - : all tracks are played randomly.
- 2 To return to normal play, press **MODE** repeatedly until play mode is no longer displayed.



Tip

- Shuffle play cannot be selected when you play programmed tracks.

Program tracks

You can program a maximum of 40 tracks.

- 1 At CD/USB mode, in the stop position, press **PROG** to activate the program mode.
 - ↳ [PROG] (program) is displayed.
- 2 For MP3/WMA tracks, press **ALBUM/PRESET+/-** to select an album.
- 3 Press **◀▶** to select a track number, and then press **PROG** to confirm.
- 4 Repeat steps 2 and 3 to select and store all tracks to program.
- 5 Press **▶||** to play the programmed tracks.
 - ↳ During play, [PROG] (program) is displayed.
 - To erase the program, in the stop position, press **■**.

Display play information

- 1 During play, press **DISPLAY** repeatedly to select different play information.

7 Adjust volume level and sound effect

Note

- MAX sound and DSC (Digital Sound Control) cannot be activated at the same time.

Adjust volume level

Caution

- For your hearing health and being consideration of other people, it is not recommended to listen at high volume levels for a long time.

- 1 During play, press **VOL +/-** to increase/decrease the volume level.

Mute sound

- 1 During play, press **MUTE** to mute/unmute sound.

Boost loudness

MAX gives an instant boost to the sound power.

- 1 Press **MAX** to turn on or off the instant power boost.
 - ↳ If MAX sound is activated, **MAX** is displayed.

Select a preset sound effect

The DSC (Digital Sound Control) enables you to enjoy special sound effects.

- 1 During play, press **DSC** repeatedly to select:
 - [JAZZ] (jazz)
 - [POP] (pop)
 - [TECHNO] (techno)
 - [OPTIMAL] (optimal)

Enhance bass

The best DBB (Dynamic Bass Enhancement) setting is generated automatically for each DSC selection. You can manually select the DBB setting that best suits your listening environment.

- 1 During play, press **DBB** repeatedly to select:
 - DBB 1
 - DBB 2
 - DBB 3
 - DBB off
 - ↳ If DBB is activated, **DBB** is displayed.

Virtual surround

You can enhance audio with a virtual surround sound effect.

- 1 Press and hold **VAC/IS** to turn on or off the incredible surround.
 - On the main unit, press **IS**.
 - ↳ If the incredible surround is activated, [INC SURR] (incredible surround) is displayed.

Customize sound for room acoustics

- 1 During play, press **VAC/IS** repeatedly to select a type of listening environment:
 - [HALL] (hall)
 - [CONCERT] (concert)
 - [CINEMA] (cinema)

8 Listen to radio

Tune to a radio station

- 1 Press **TUNER** repeatedly to select FM or AM.
- 2 Press and hold **◀▶** for more than 2 seconds.
 - ↳ [SEARCH] (search) is displayed.
 - ↳ The radio tunes to a station with strong reception automatically.
- 3 Repeat step 2 to tune to more stations.
 - To tune to a weak station, press **◀◀** / **▶▶** repeatedly until you find optimal reception.

Program radio stations automatically

You can program a maximum of 40 preset radio stations.

- 1 In the tuner mode, press and hold **PROG** for more than 2 seconds to activate automatic program mode.
 - ↳ [AUTO] (auto) is displayed.
 - ↳ All available stations are programmed in the order of waveband reception strength.
 - ↳ The first programmed radio station is broadcast automatically.

Program radio stations manually

You can program a maximum of 40 preset radio stations.

- 1 Tune to a radio station.
- 2 Press **PROG** to activate program mode.
↳ [PROG] (program) blinks on the display.
- 3 Press **ALBUM/PRESET+/-** to allocate a number to this radio station, and then press **PROG** to confirm.
↳ The preset number and the frequency of the preset station are displayed.
- 4 Repeat the previous steps to program other stations.

Tip

- To overwrite a programmed station, store another station in its place.

Select a preset radio station

- 1 In tuner mode, press **ALBUM/PRESET+/-** to select a preset number.

Tip

- Position the antenna as far as possible from TV, VCR, or other radiation source.
- For optimal reception, fully extend and adjust the position of the antenna.

9 USB/SD record

Audio CD tracks, MP3 files, radio, and audio from external devices are recorded in .mp3 format, and WMA files are recorded in .wma format.

The first time you record to a USB/SD device, a folder called 'PHILIPS' is automatically created in the USB/SD device. Each time you record to a USB/SD device, the recorded files are stored in a subfolder in the 'PHILIPS' folder. Files and subfolders are named numerically in the order in which they are created.

Record to a USB/SD device

- 1 Connect a USB/SD device.
- 2 Prepare the source to record from.
 - Disc - Select the disc source and load a disc. You can select a track from which a recording starts.
 - Radio - Tune to a radio station.
 - MP3 LINK/AUX - Select the MP3 link/AUX source, and then connect and start to play an external device.
 - Karaoke - Singing during karaoke.
- 3 Press **USB RECORD** or **SD RECORD** to start recording.
 - For discs, press **USB RECORD** or **SD RECORD** repeatedly to select:
 - (A) [REC ONE] (record one): the first/current track is recorded.
 - (B) [REC ALL] (record all): all tracks/the remaining tracks are recorded.
 - ↳ Disc play starts automatically from the beginning of the disc/the selected track, and the recording starts.
 - To stop recording, press ■.

Tip

- If the USB/SD device does not have enough memory to store the audio files, a message about a full memory is displayed.

Record CDDA contents to USB/SD device with high speed

To record the CDDA content into a USB/SD storage device with high speed,

- 1 Connect a USB/SD device.
- 2 Press **DISC** to select the disc source.
- 3 Load a CDDA disk.
- 4 Press **■** to stop play.
- 5 Press and hold **USB RECORD** or **SD RECORD** until [HIGH SPEED RECORDING] is displayed.
 - Press **USB RECORD** or **SD RECORD** repeatedly to select:
 - (A) [REC ONE] (record one): the first/current track is recorded.
 - (B) [REC ALL] (record all): all tracks/the remaining tracks are recorded.
 - ↳ The recording starts.
 - To stop recording, press **■**.

Tip

- If the USB/SD device does not have enough memory to store the audio files, a message about a full memory is displayed.
- During high speed recording, speaker will be no sound output.

Record CDDA contents to a USB/SD device at any playback time

Note

- Make sure that the USB/SD storage device is connected to the main unit.

To record the CDDA content into a USB/SD storage device at any playback time:

- 1 Press **USB RECORD** or **SD RECORD** during CDDA playback.
 - ↳ The recording starts.

- 2 Press **■** to stop recording.

Tip

- If the USB/SD storage device does not have enough memory to store the audio files, a message about a full memory is displayed.
- Anytime recording is not available for CD-MP3 and CD-WMA discs.
- Anytime recording is not available for High speed recording.

Schedule radio-to-USB/SD record

Schedule radio recordings in advance and you can listen to your favorite programs at your convenience.

Note

- A recording is activated only in the standby mode.
- The maximum length of a recording is 12 hours.

- 1 Ensure that you set the clock correctly.
- 2 Plug a USB/SD device.
- 3 Tune to a radio station.
- 4 Press **⏻** to switch to standby mode.
- 5 Press and hold **TIMER** for more than 2 seconds.
 - ↳ A prompt to select the source is displayed.
- 6 Press **TUNER** repeatedly to select FM or AM.
- 7 Press **USB RECORD** or **SD RECORD**.
 - ↳ The start timer digits are displayed and begin to blink.
- 8 Press **ALBUM/PRESET+/-** to set the hour.
- 9 Press **◀▶** to set the minute.
- 10 Press **TIMER** to confirm.

- ↳ The end timer digits are displayed and begin to blink.

11 Press **ALBUM/PRESET+/-** to set the hour.



12 Press **◀▶** to set the minute.

13 Press **TIMER** to confirm.

- ↳  is displayed.
- ↳ At the scheduled times, the recording begins and ends automatically.
- ↳ When the recording ends, the unit switches to standby mode.

To deactivate or reactivate a record timer

1 In the standby mode, press **TIMER** repeatedly.

- ↳ If the timer is activated,  is displayed.
- ↳ If the timer is deactivated,  disappears.

10 Other features

Set the alarm timer



This unit can be used as an alarm clock. A disc, radio, or USB/SD device is activated to play at a preset time.

Note

- If you have set a record timer and an alarm timer, only the latest timer is activated.

- 1** Ensure that you have set the clock correctly.
- 2** Press  to switch to standby mode.
- 3** Press and hold **TIMER** for more than 2 seconds.
 - ↳ A prompt to select the source is displayed.
- 4** Press **CD 1/2/3**, or **TUNER** or **USB/SD** to select a source.
- 5** Press **TIMER** to confirm.
 - ↳ The clock digits are displayed and begin to blink.
- 6** Press **ALBUM/PRESET+/-** to set the hour.
- 7** Press **◀▶** to set the minute.
- 8** Press **TIMER** to confirm.
 - ↳ The timer is set and activated.

To deactivate or reactivate an alarm timer

- 1** In the standby mode, press **TIMER** repeatedly.
 - ↳ If the timer is activated,  is displayed.
 - ↳ If the timer is deactivated,  disappears.

Tip

- In MP3 link or AUX mode, the alarm timer cannot be set.
- If a disc or USB/SD source is selected but no audio file can be played, radio is activated automatically.

Set the sleep timer

This unit can switch to standby automatically after a set period.

- 1 When the unit is turned on, press **SLEEP** repeatedly to select a set period (in minutes).
 - ↳ When sleep timer is activated, **zZ** is displayed.

To deactivate sleep timer

- 1 Press **SLEEP** repeatedly until [OFF] (off) is displayed.
 - ↳ When sleep timer is deactivated, **zZ** disappears on the display.

Listen to an external device

You can listen to an external audio device through this unit.

For audio players with headphone sockets

- 1 Press **MP3 LINK/AUX** repeatedly to select the MP3 link source.
- 2 Connect the supplied MP3 link cable to:
 - the **MP3 LINK** jack (3.5mm) on the unit.
 - the headphone jack on an external device.
- 3 Start to play the device (refer to the device's user manual).

For audio players with red/white audio output sockets

- 1 Press **MP3 LINK/AUX** repeatedly to select the AUX source.
- 2 Connect the audio cables (white/red jacks, not supplied) to:

- the **AUX IN** jacks on the back of the unit.
- the **AUDIO OUT** jacks on an external device.

- 3 Start to play the device (refer to the device's user manual).

Delete from a USB/SD device

- 1 During play from a USB/SD device, press **◀◀▶▶** to select an audio file.
 - To delete an audio folder; in the stop position, press **ALBUM/PRESET+/-** to select an audio folder.
- 2 Press **USB DELETE** or **SD DELETE**.
 - ↳ A confirmation message is displayed.
- 3 While the message is displayed, press **USB DELETE** or **SD DELETE** again to confirm.
 - To cancel, press **■**.

Copy files between SD and USB device

You can copy MP3 / WMA file between USB and SD device.

- 1 Connect both USB and SD devices.
- 2 Press **USB/SD** to select the USB/SD source.
- 3 Select an audio file.
- 4 Press **USB to SD** or **SD to USB** to start copy.
 - You can press **USB to SD** or **SD to USB** repeatedly to select:
 - (A) [COPY ONE] (copy one): the first/current file is copied.
 - (B) [COPY ALL] (copy all): all files/the remaining files are copied.
 - ↳ The track number and the percentage of copy progress are displayed.
 - Press **■** to stop copy.

Karaoke

You can connect a microphone and sing along with a music source.

- 1 Turn **MIC VOL** to the minimum level.
- 2 Connect a microphone to the microphone port on the unit.
- 3 Press **CD 1/2/3**, or **TUNER**, or **USB**, or **MP3 LINK/AUX** to select the source, and start play.
- 4 Sing through the microphone.
 - To adjust the volume of the source, press **VOL +/-**.
 - To adjust the volume of the microphone, turn **MIC VOL**.

11 Product information



Note

- Product information is subject to change without prior notice.

Specifications

Amplifier

Total output power	800W RMS
Frequency response	60 - 16kHz
Signal-to-noise ratio	>67dB A (IEC)
Aux input	1500mV/2000mV

Disc

Laser type	Semiconductor
Disc diameter	12cm/8cm
Support disc	CD-DA, CD-R, CD-RW, MP3-CD, WMA-CD
Audio DAC	24Bits / 44.1kHz
Total harmonic distortion	<1.5%
Frequency response	60Hz -16kHz (44.1kHz)
S/N ratio	>75dBA

Tuner

Tuning range	FM: 87.5 - 108MHz; AM: 531 - 1602kHz (9KHz); 530 - 1700KHz (10KHz)
Tuning grid	50KHz (FM); 9KHz/10KHz (AM)
Number of presets	40
FM	75ohm wire
AM	loop antenna

Speakers

Speaker Impedance	3ohm
Woofers	2 x 8"
Tweeter	2 x 2"
Dimensions (W x H x D)	263 x 447 x 360 mm
Weight	7.151kg each

Subwoofer

Speaker impedance	8ohm
Speaker driver	10"
Output power	300W
Dimensions (W x H x D)	337 x 491 x 360 mm
Weight	9.81 kg

General information

AC power	110 - 127/220 - 240V, 50/60Hz
Operation power consumption	120W
Standby power consumption	<10W
USB direct	Version 2.0/1.1
Dimensions Main Unit (W x H x D)	265 x 359 x 353 mm
Weight (without speakers)	6.5 kg

USB playability information

Compatible USB devices:

- USB flash memory (USB 2.0 or USB 1.1)
- USB flash players (USB 2.0 or USB 1.1)
- memory cards (requires an additional card reader to work with this unit)

Supported formats:

- USB or memory file format FAT12, FAT16, FAT32 (sector size: 512 bytes)
- MP3 bit rate (data rate): 32-320 Kbps and variable bit rate
- WMA v9 or earlier
- Directory nesting up to a maximum of 8 levels
- Number of albums/ folders: maximum 99
- Number of tracks/titles: maximum 999
- ID3 tag v2.0 or later
- File name in Unicode UTF8 (maximum length: 128 bytes)

Unsupported formats:

- Empty albums: an empty album is an album that does not contain MP3/ WMA files, and is not be shown in the display.

- Unsupported file formats are skipped. For example, Word documents (.doc) or MP3 files with extension .dlf are ignored and not played.
- AAC, WAV, PCM audio files
- DRM protected WMA files (.wav, .m4a, .m4p, .mp4, .aac)
- WMA files in Lossless format

- Do not use solvents such as benzene, thinner, commercially available cleaners, or antistatic spray intended for analogue records.

Clean the disc lens

- After prolonged use, dirt or dust may accumulate at the disc lens. To ensure good play quality, clean the disc lens with Philips CD lens cleaner or any commercially available cleaner. Follow the instructions supplied with cleaner.

Supported MP3 disc formats

- ISO9660, Joliet
- Maximum title number: 999 (depending on file name length)
- Maximum album number: 99
- Supported sampling frequencies: 32 kHz, 44.1kHz, 48 kHz
- Supported Bit-rates: 32-320 (kbps), variable bit rates
- ID3 tag v2.0 or later
- Directory nesting up to a maximum of 8 levels

Maintenance

Clean the cabinet

- Use a soft cloth slightly moistened with a mild detergent solution. Do not use a solution containing alcohol, spirits, ammonia or abrasives.

Clean discs

- When a disc becomes dirty, clean it with a cleaning cloth. Wipe the disc from the centre out.

