

Register your product and get support at
www.philips.com/welcome

HTS5540



Quick Start

PHILIPS

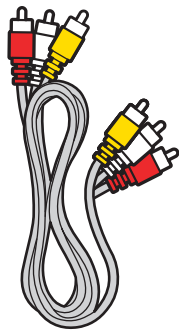
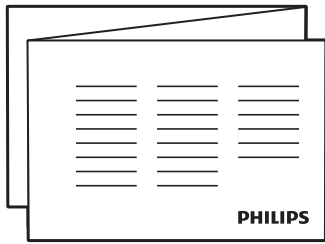
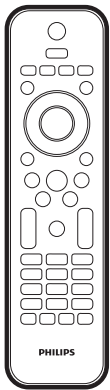
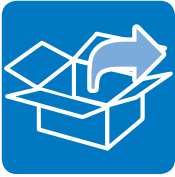

Audio/Video



FM Antenna

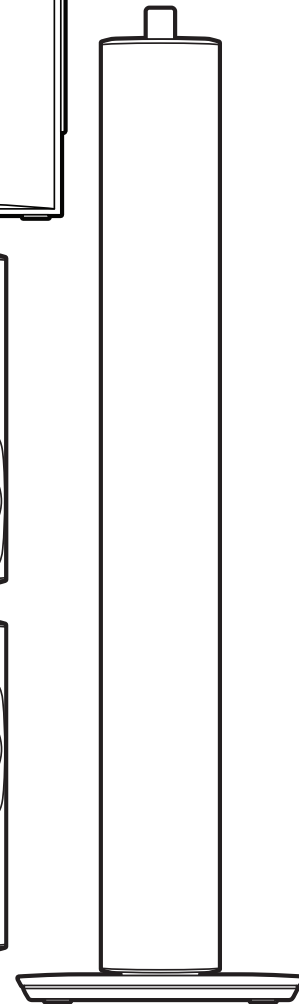
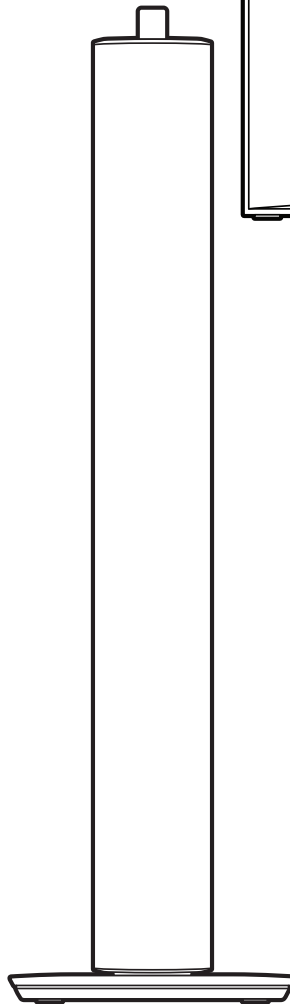
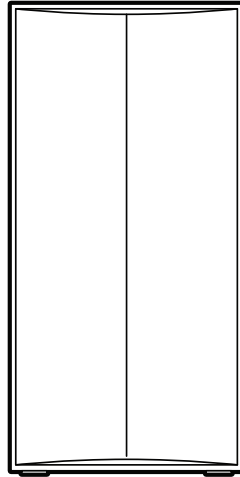

1

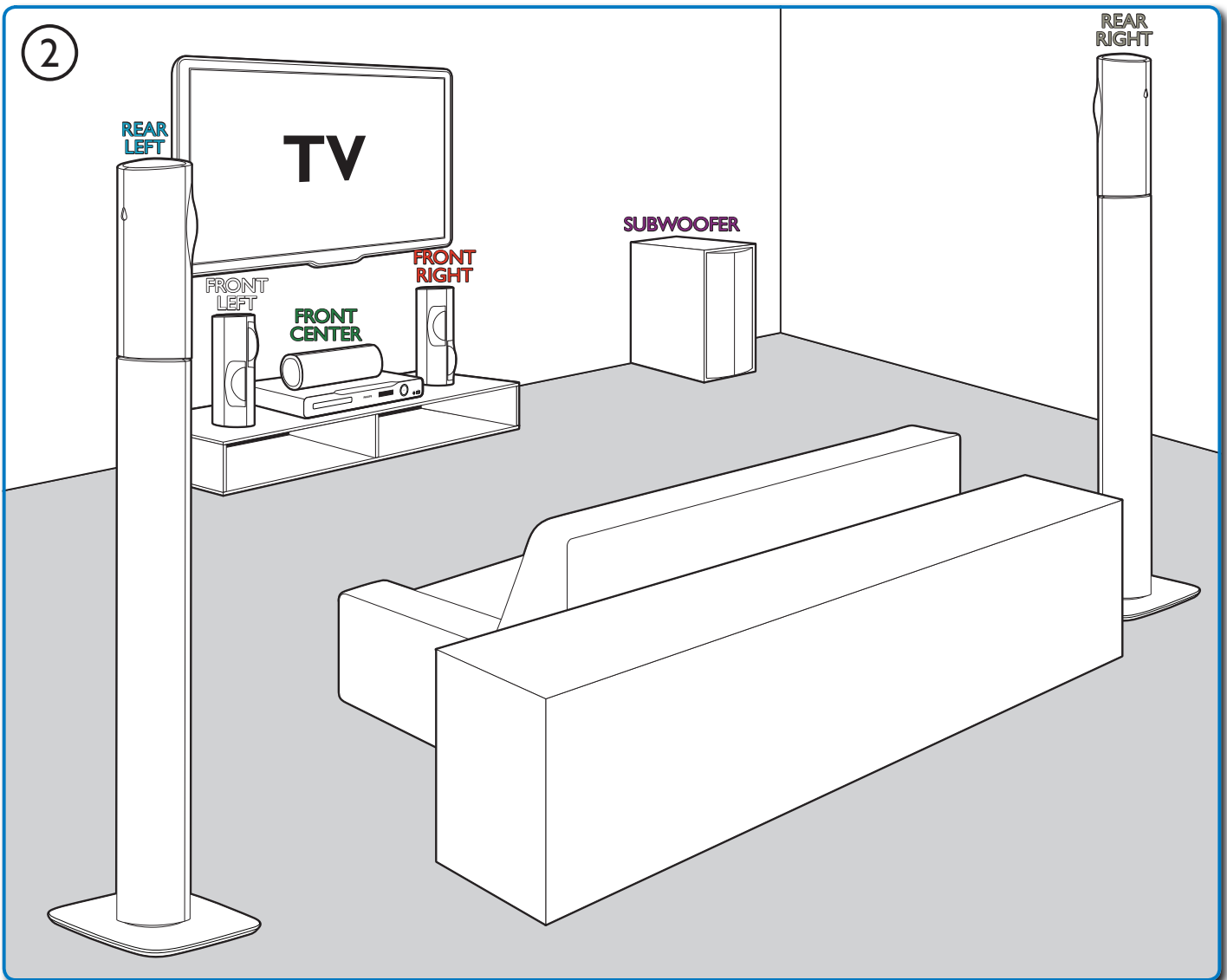
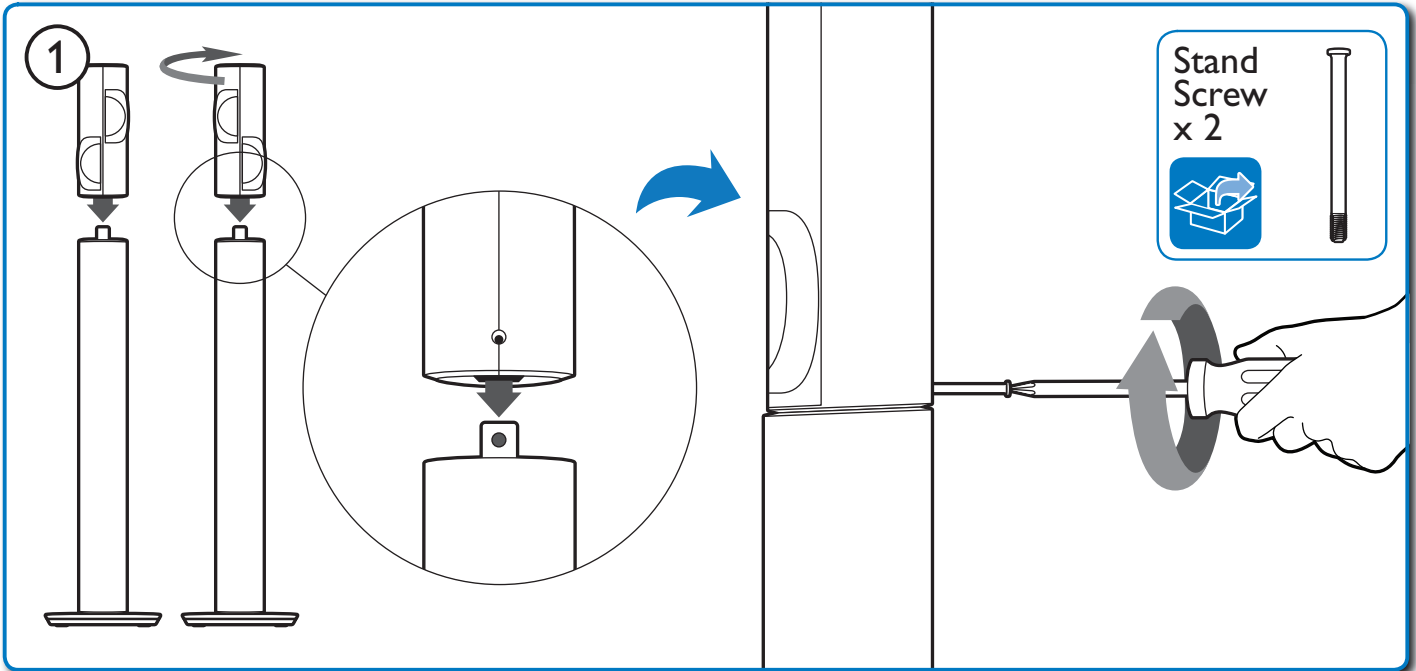

3

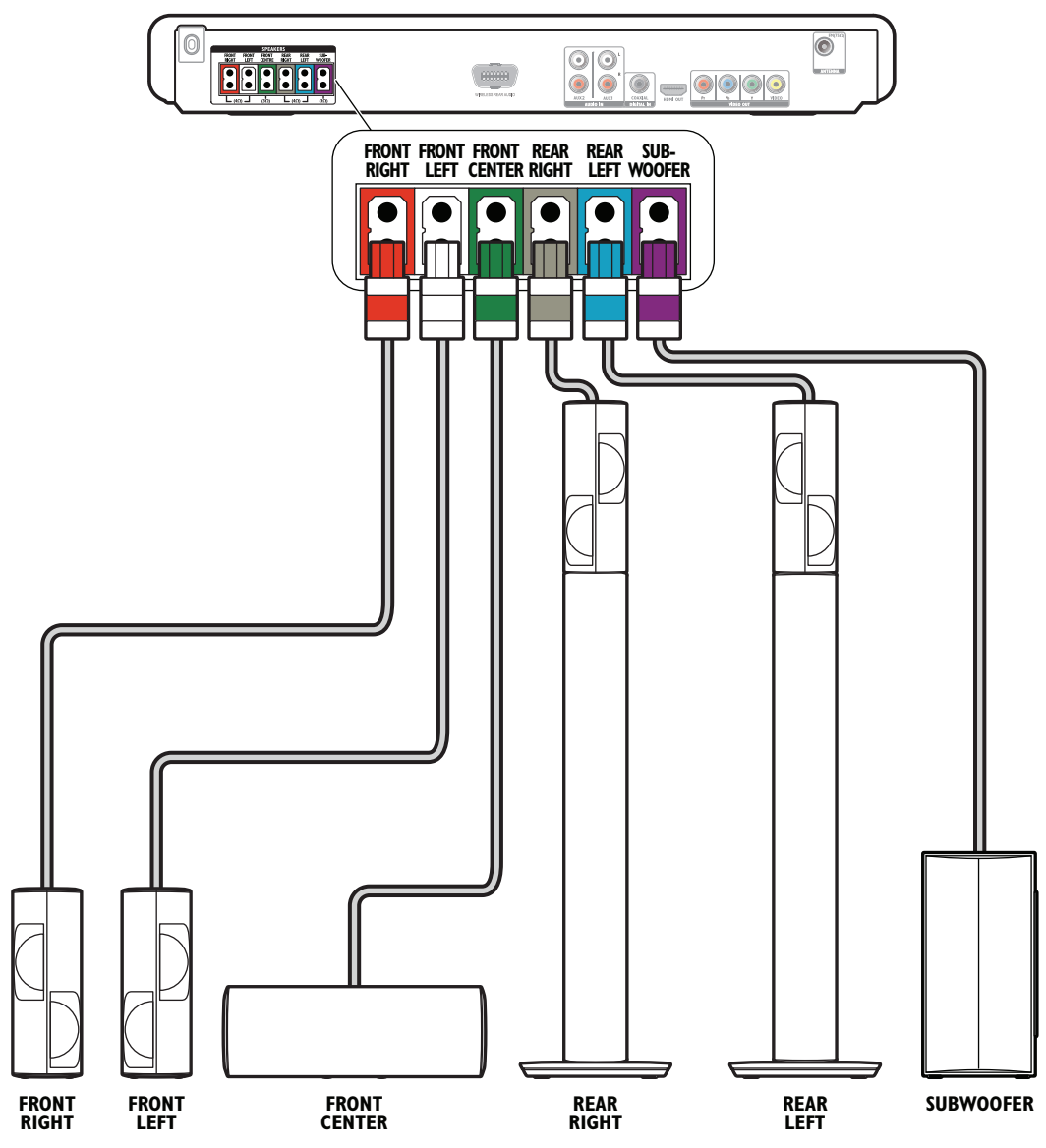

4

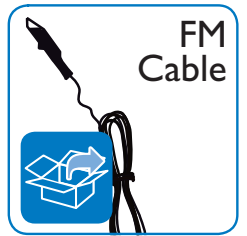
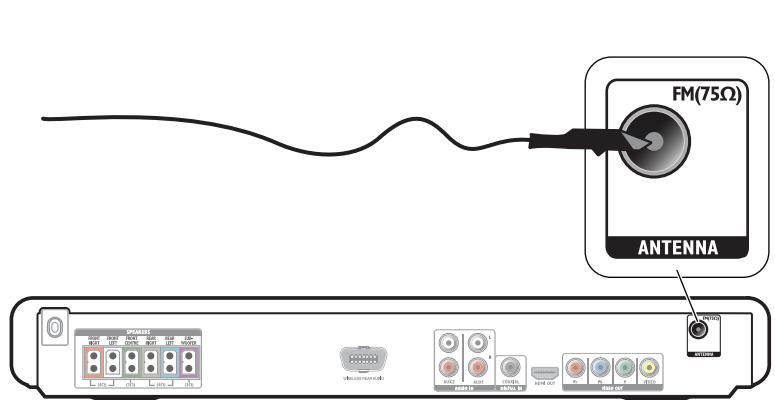

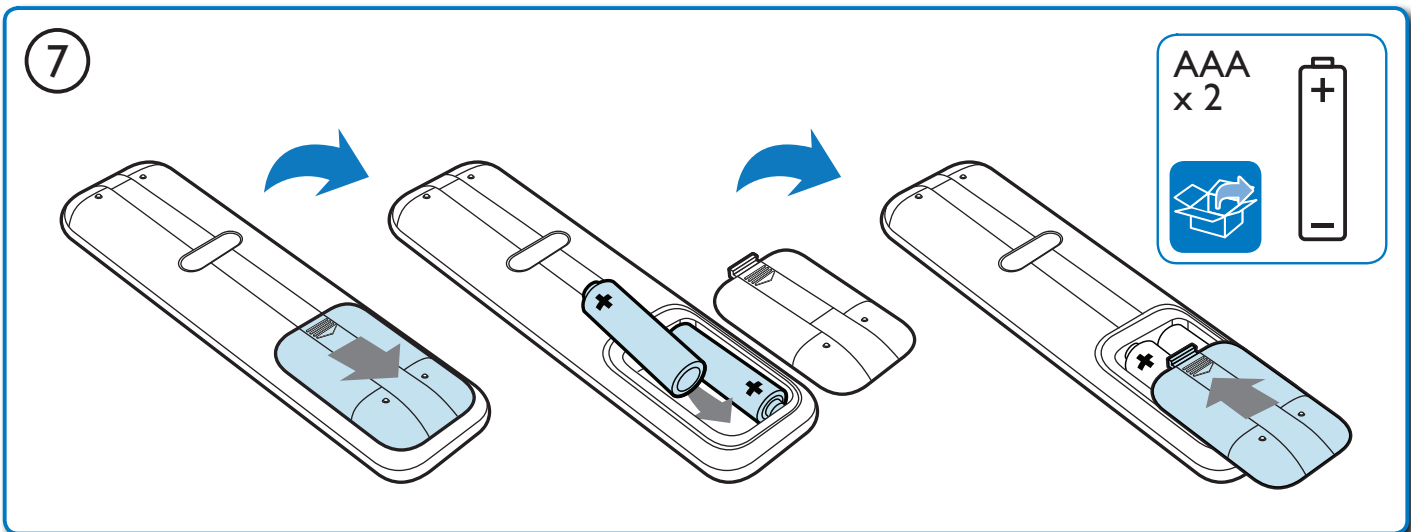
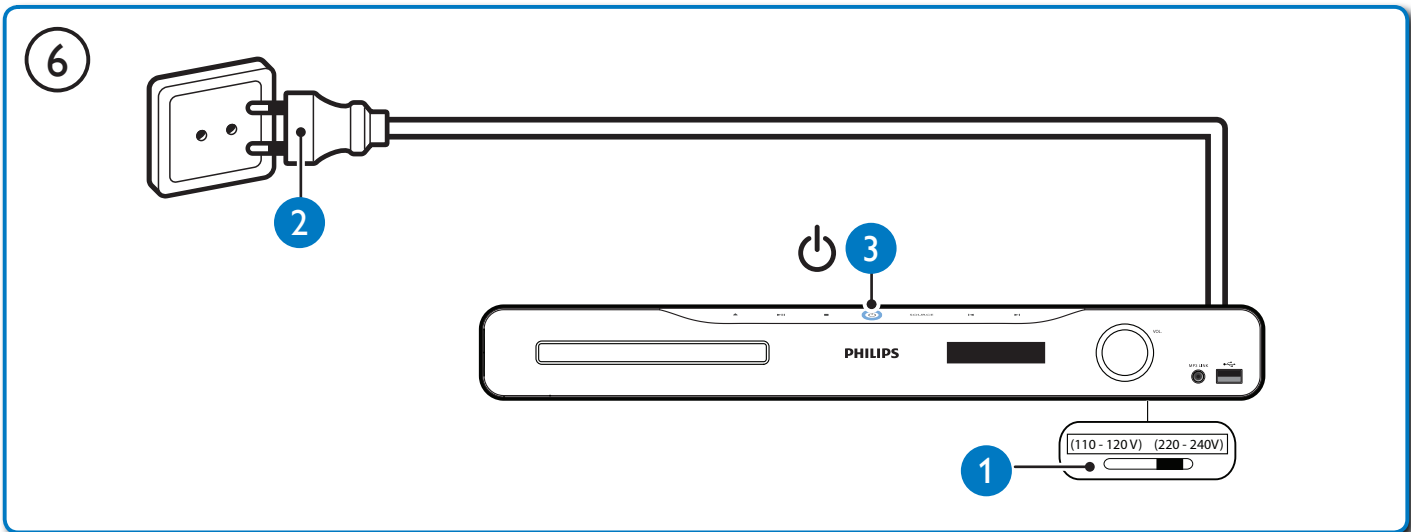
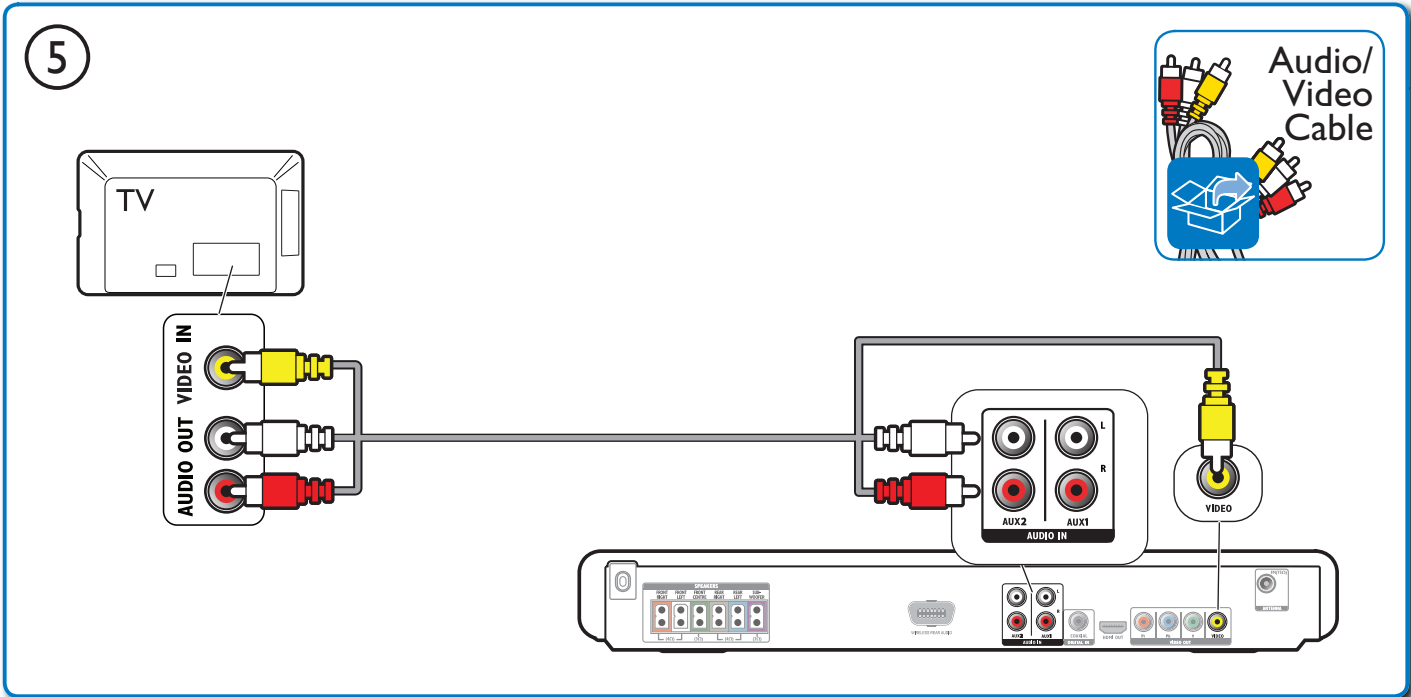

2

1

TV

SOURCE

TV

AV

HTS

HOME THEATER

2

3

HOME THEATER

5

6

HOME THEATER

General Setup

Easylink Setup

Disc Lock

Display Dim

OSD Language

Screen Saver

Sleep Timer

DivX(R) VOD Code

General Setup

Easylink Setup

Disc Lock

Display Dim

OSD Language

Screen Saver

Sleep Timer

DivX(R) VOD Code

Auto

English

中文 (繁體)

Melayu

ไทย

中文 (简体)

Русский

Українська

3

DISC

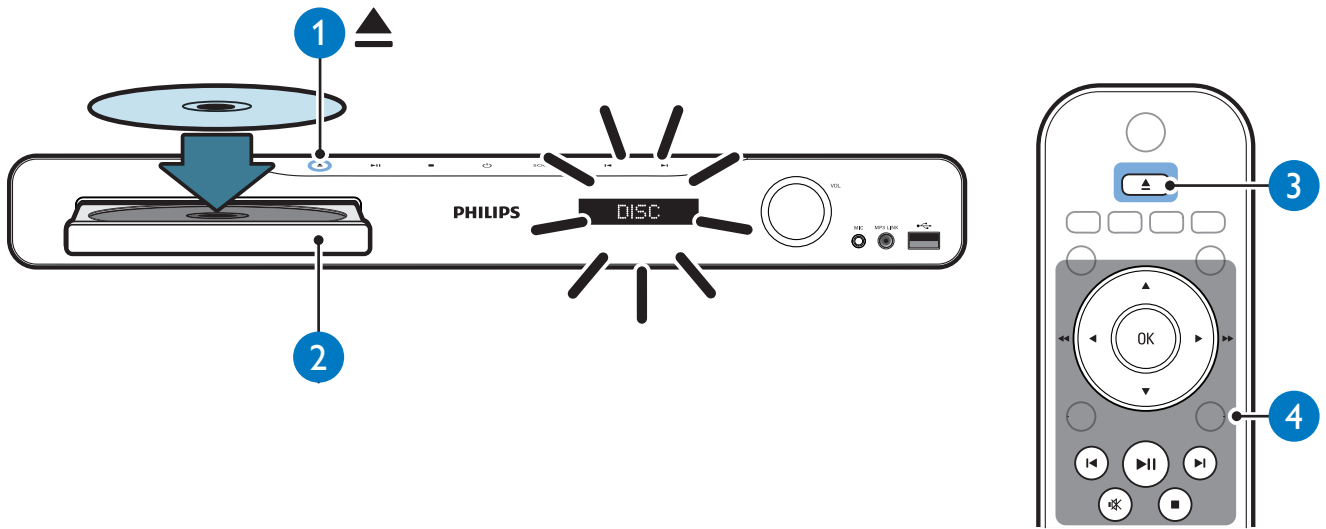

FM

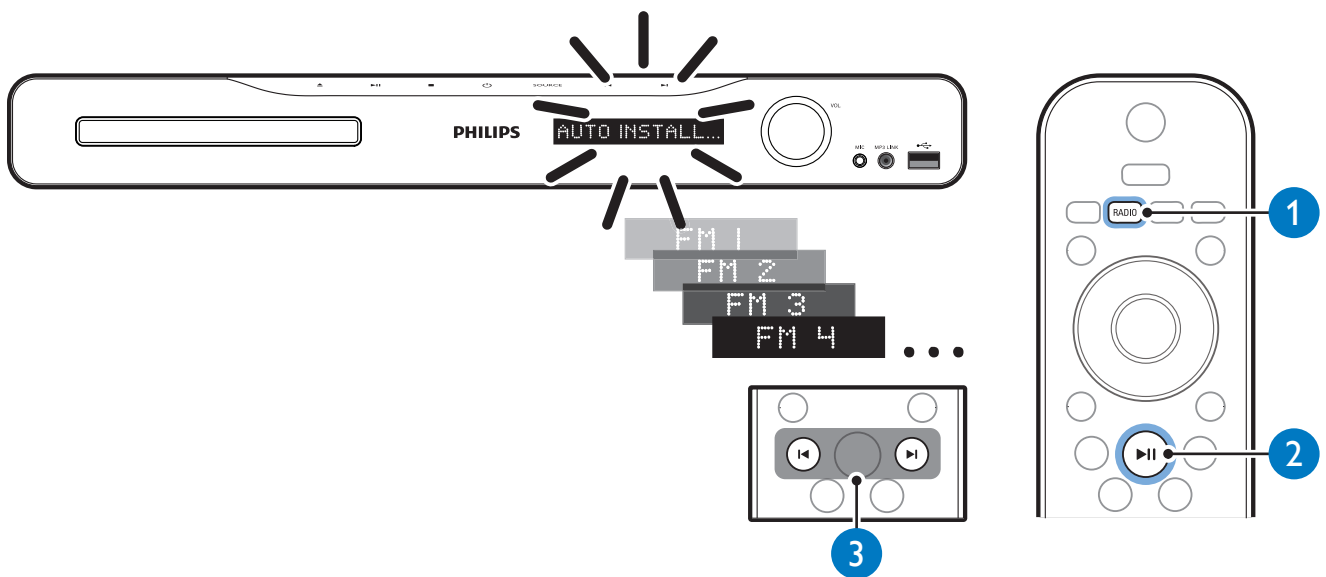

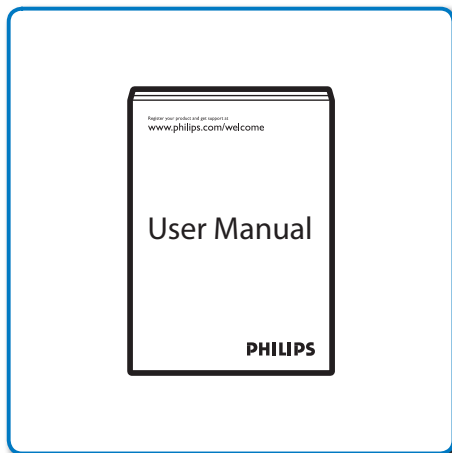
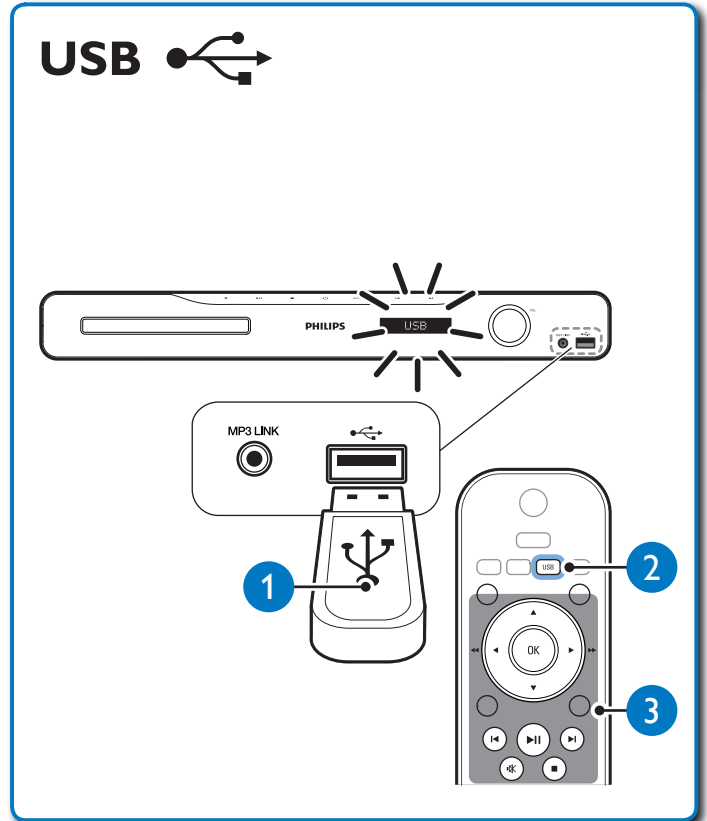
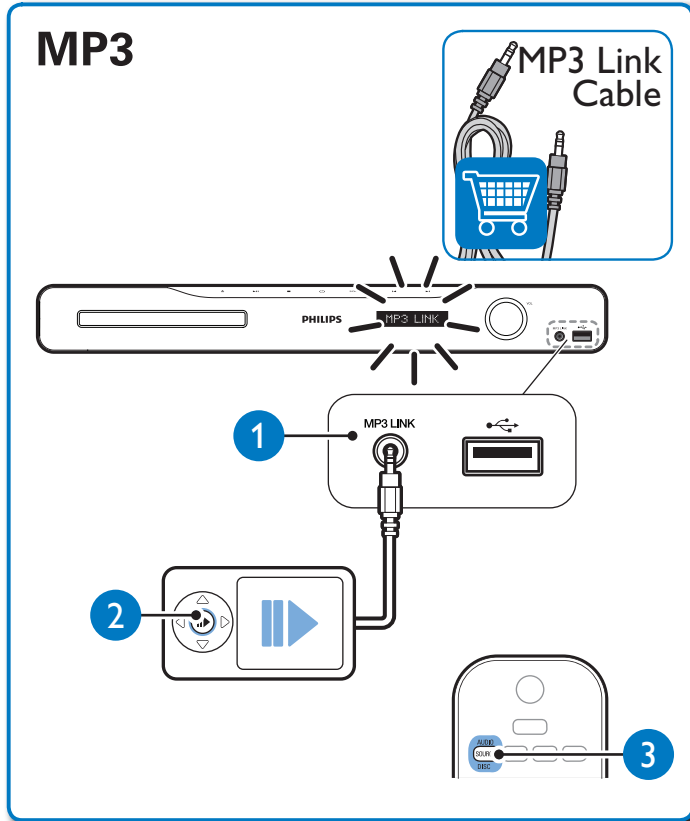

Specifications are subject to change without notice
Trademarks are the property of Koninklijke Philips Electronics N.V.
or their respective owners
2010 © Koninklijke Philips Electronics N.V. All rights reserved.
sgttcs_1002/98_v1

Be responsible
Respect copyrights

