

Quick Start Guide



Step A *Connect*

Step B *Setup*

Step C *Enjoy*

What's in the Box?

You should find these items upon opening the box.

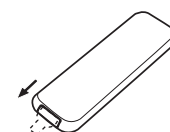
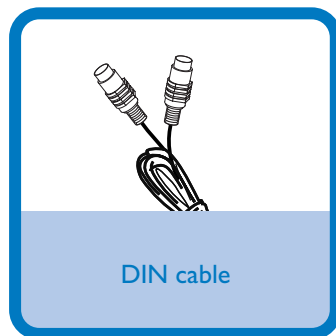
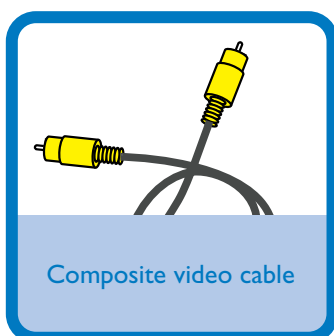

Remove the insulation plastic tab before use

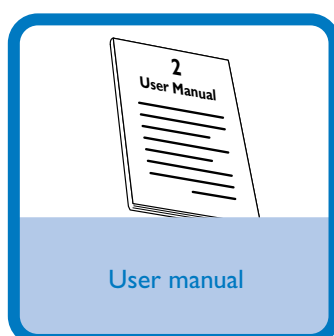
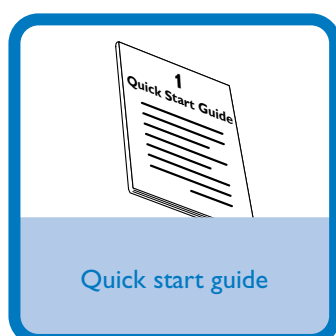
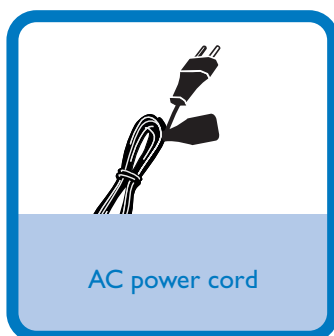

Step A **Connect**

Important!

- This set can only be operated after the supplied DIN cable has been connected.
- Before connecting the AC power cord to the wall socket, make sure that the **VOLTAGE SELECTOR** (located on the rear of the left speaker) is adjusted to match the local power voltage.

Tips

- See the User Manual for other TV connection options.
- For connecting to a Progressive Scan TV, refer to the user manual for proper connections and detailed setup.

- 1 Connect the speaker wires of the right speaker and subwoofer to the left speaker.
- 2 Connect the left speaker and the DVD player by using the supplied DIN cable.
- 3 Connect the DVD player to your TV by using the supplied composite video cable.
- 4 Connect the supplied power cord to the left speaker and the wall socket.

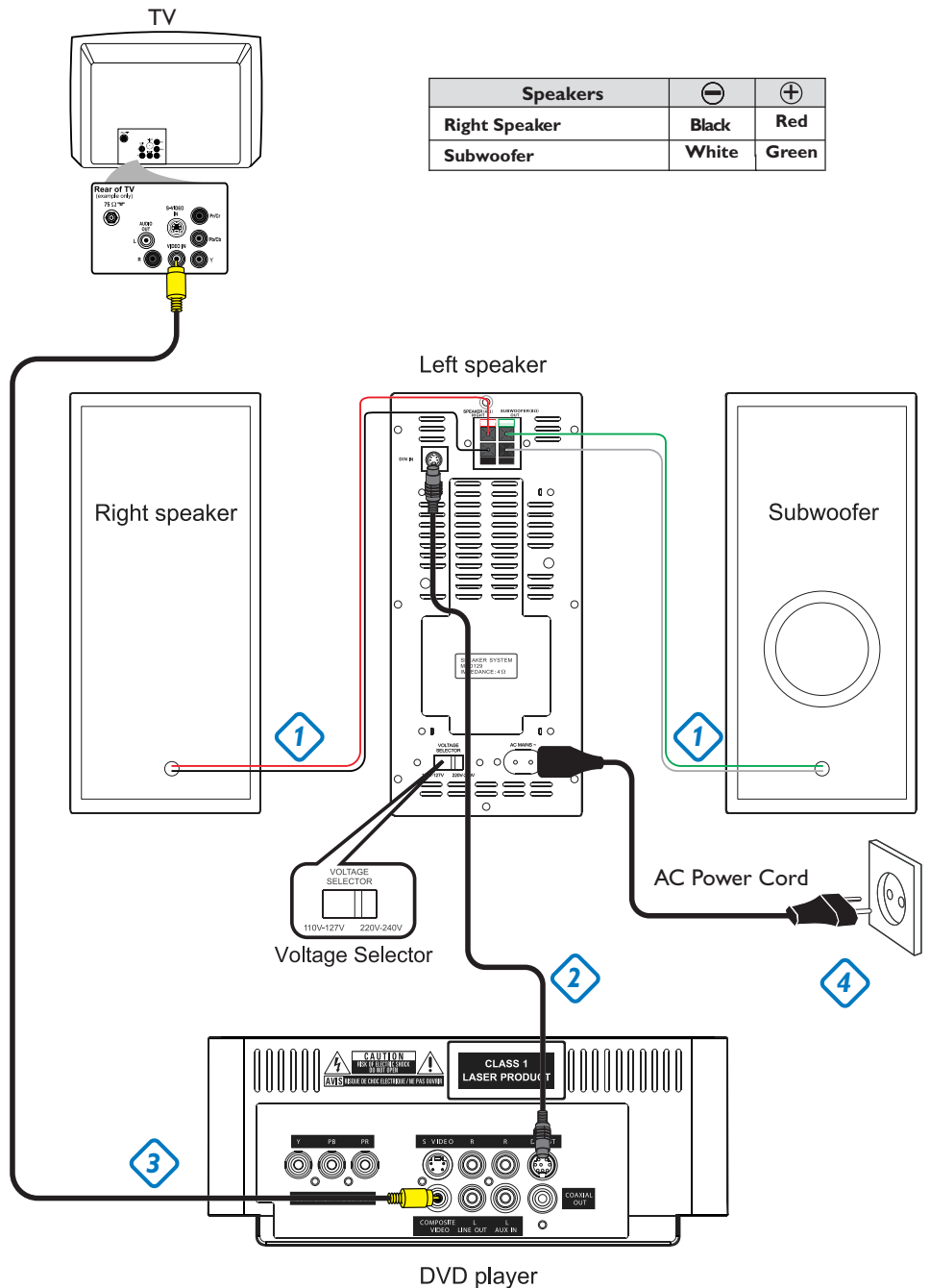

Step B Setup

Setting up the TV

- 1 Press **SOURCE** (**DISC** on the remote) to select disc source.
- 2 Turn on the TV and set it to the correct Video In channel.

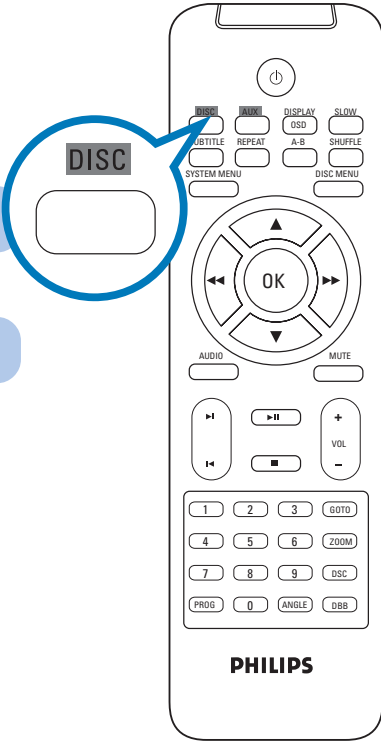

Setting DVD menu options

IMPORTANT!

If the progressive scan feature is activated but the connected TV does not support progressive signals or the video cables are not connected accordingly, see the user manual for proper progressive scan setup or deactivate the progressive scan feature as below:

- 1) Turn off your TV progressive scan mode or turn on to interlaced mode.
- 2) Select "OFF" in PROGRESSIVE menu of the system setup menu to turn off progressive scan, then press **SYSTEM MENU** on the remote to exit the system menu.

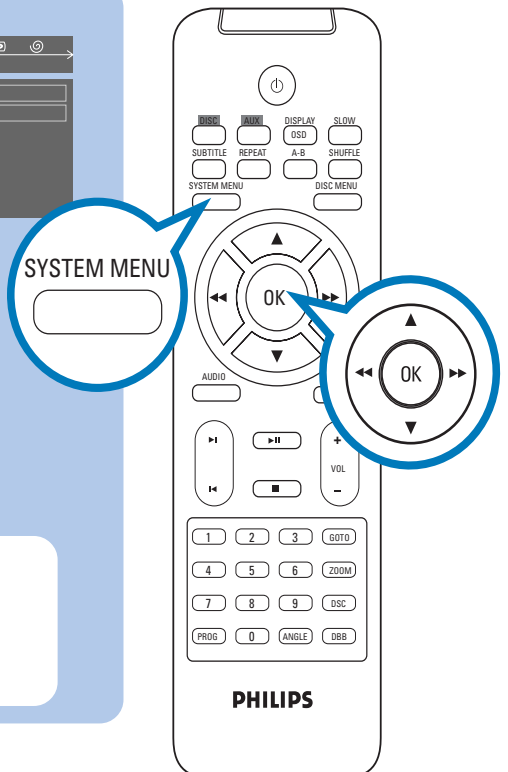
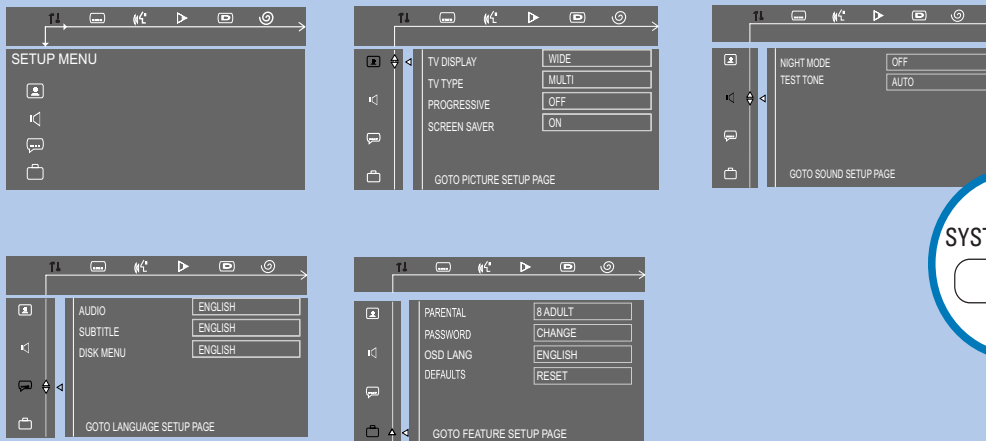

Tip

See chapters "Getting Started" and "DVD menu operations" in the User Manual for detailed descriptions.

Playing a disc

1

Push **OPEN /CLOSE** ▲ to open the disc door.

2

Load in a disc with the label side facing up, then close the disc door.

3

Playback will start automatically. If not, press ► **II**.

4

To stop playback, press ■.

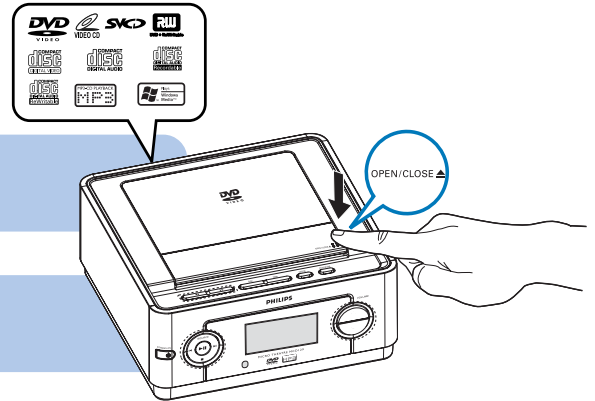

Tip

Detailed playback features and additional functions are described in the accompanied user manual.

Notes for the remote control:

- First, select the source you wish to control by pressing one of the source select keys on the remote control (DISC or AUX, for example).
- Then select the desired function (►II, ◀, ▶ for example).

