

## DVD Portable with dock for iPod

Register your product and get support at  
[www.philips.com/welcome](http://www.philips.com/welcome)

User manual

DCP851  
DCP951  
DCP852



**PHILIPS**

**Important notes for users in the U.K.****Mains plug**

This apparatus is fitted with an approved 13 Amp plug. To change a fuse in this type of plug proceed as follows:

1. Remove fuse cover and fuse.
2. Fix new fuse which should be a BS1362 3 Amp, A.S.T.A. or BSI approved type.
3. Refit the fuse cover.

If the fitted plug is not suitable for your socket outlets, it should be cut off and an appropriate plug fitted in its place. If the mains plug contains a fuse, this should have a value of 3 Amp. If a plug without a fuse is used, the fuse at the distribution board should not be greater than 3 Amp.

Note: The severed plug must be disposed of to avoid a possible shock hazard should it be inserted into a 13 Amp socket elsewhere.

**How to connect a plug**

The wires in the mains lead are coloured with the following code: blue = neutral (N), brown = live (L). As these colours may not correspond with the colour markings identifying the terminals in your plug, proceed as follows:

- Connect the blue wire to the terminal marked N or coloured black.
- Connect the brown wire to the terminal marked L or coloured red.
- Do not connect either wire to the earth terminal in the plug, marked E (or e) or coloured green (or green and yellow).

Before replacing the plug cover, make certain that the cord grip is clamped over the sheath of the lead - not simply over the two wires.

**Copyright in the U.K.**

Recording and playback of material may require consent. See Copyright Act 1956 and The Performer's Protection Acts 1958 to 1972.

**Main unit controls ( see figure 1)**

- ① **MENU**.....Display the MENU page.
- ② **▶||** .....Start or interrupt playback.
- ③ **▲, ▼, ◀, ▶** .....Navigate in a menu.  
.....(◀ / ▶) search backward/forward in a disc at different speeds.
- OK** .....Confirm a selection.  
.....Power indicator
- ④ **◀◀ / ▶▶** .....Skip to the previous/next chapter, track or title.
- ⑤ **DOCK for iPod**.....Place an iPod player.

**Top of player ( see figure 1)**

- ⑥ **OPEN** .....Open the disc door to insert or remove disc.
- ⑦ **MONITOR**.....Switch the aspect ratio between 16:9 or 4:3.
- ⑧ **SOURCE**.....Select respective sources: DISC, iPod, SD/MMC or AV.
- ⑨ **ON/OFF** ... .....Switch the power on/off.

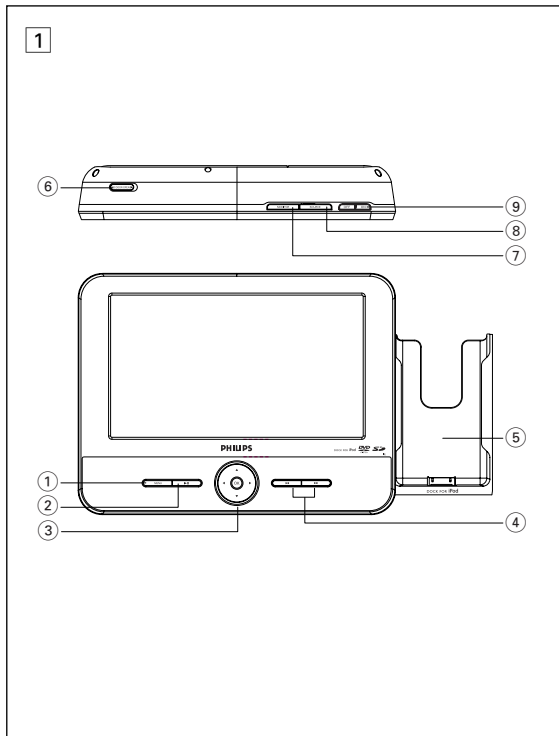

## FUNCTIONAL OVERVIEW

### Left of player ( see figure 2 )

- ⑩ **1**  **2** .....Headphone jacks.
- ⑪ **AV OUT**.....Audio/Video output jack.
- ⑫ **AV IN**.....Audio/Video input jack.
- ⑬ **VOL +/-** .....Volume control.
- ⑭ **SD/MMC CARD**.....Insert an SD/MMC card.
- ⑮ **9V DC IN and CHG** .....Power supply socket.  
..... charge indicator

### Right of player ( see figure 2 )

- ⑯ **iPod EJECT**.....Push to eject the iPod player.

### Desk stand of the player ( see figure 3 )

You can prop up the DVD player on your table for movie watching.  
Pull out the stand at the rear of the player.

## CAUTION

*Use of controls or adjustments or performance of procedures other than herein may result in hazardous radiation exposure or other unsafe operation.*

2

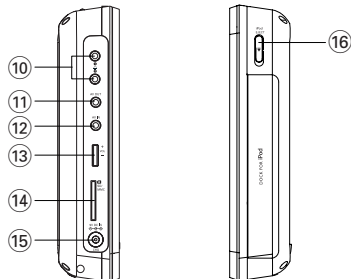

3

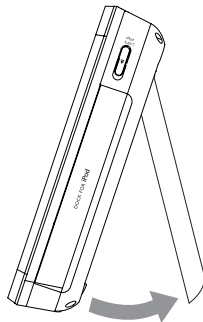

## REMOTE CONTROL

### Remote controls ( see figure 4 )

- ① **Source keys** .....Select respective sources: DISC, iPod, SD/MMC or AV.
- ② **REPEAT** .....Repeat a chapter/track/title.
- ③ **A-B** .....Repeat playback of a specific section on a disc.
- ④ **SHUFFLE** .....Play a disc randomly.
- ⑤ **PROG** .....Enter the program menu.
- ⑥ **■** .....Stop playback or erase a program.
- ⑦ **▶||** .....Start or interrupt playback.
- ⑧ **MENU** .....Enter or exit the disc contents menu.
- ⑨ **SETUP** .....Enter or exit the system menu.
- ⑩ **▲, ▼, ◀, ▶** .....Navigate in a menu.  
 (◀ / ▶) search backward/forward in a disc at different speeds.
- ⑪ **OK** .....Confirm a selection.
- ⑫ **◀◀ / ▶▶** .....Skip to the previous/next chapter, track or title.
- ⑬ **Numeric Keypad (0-9)**...Input numbers.
- ⑭ **ZOOM** .....Enlarge or reduce a picture or active image on the TFT.
- ⑮ **MONITOR** .....Switch the aspect ratio between 16:9 or 4:3.
- ⑯ **DISPLAY** .....Display information on TFT during playback.
- ⑰ **TITLE/RETURN** .....Display the disc title or return to the previous level of the VCD disc menu.
- ⑱ **SUBTITLE** .....Select a subtitle language.
- ⑲ **AUDIO** .....Select an audio language when playing a DVD disc or select an audio mode (Stereo, Mono-Left or Mono-Right) when playing a VCD/CD disc.

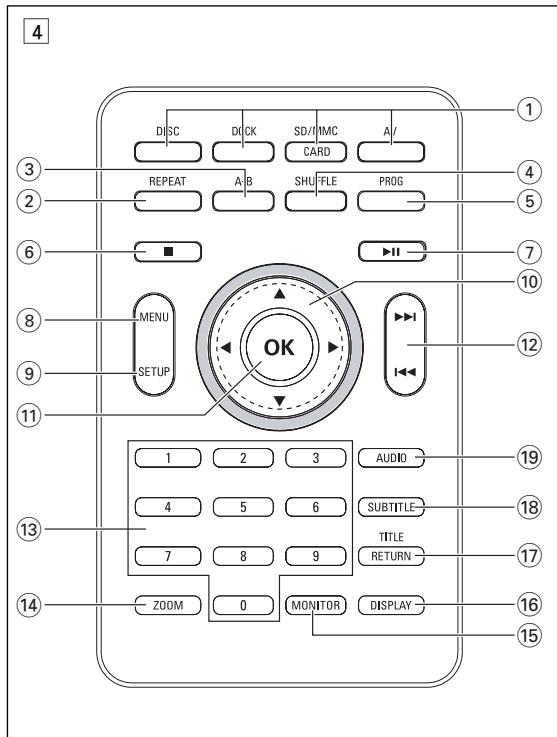

## INTRODUCTION

### Your portable DVD player

Your portable DVD player plays digital video discs conforming to the universal DVD Video standard. With it, you will be able to enjoy full-length movies with true cinema picture quality, and stereo or multichannel sound (depending on the disc and on your playback set-up).

The unique features of DVD-Video, such as selection of soundtrack and subtitle languages, and of different camera angles (again depending on the disc), are all included.

What's more, parental lock lets you decide which discs your children will be able to see. You will find your player remarkably easy to use with the On-Screen Display and player display in combination with the remote control.

### Unpacking

First check and identify the contents of your package, as listed below:

- Portable DVD player
- Remote Control
- Car adaptor (12V)
- Audio / Video cable
- User Manual
- Warranty
- Quick Start Guide
- AC power adaptor, DSA-9W-09 F (DVE), AY4132 (PHILIPS) or AY4193 (PHILIPS)

### Placement

- Place the player on a firm, flat surface.
- Keep away from domestic heating equipment and direct sunlight.
- If the player cannot read CDs/DVDs correctly, try using a commonly available cleaning CD/DVD to clean the lens before taking the player to be repaired. Other cleaning methods may destroy the lens.
- Always keep the disc door closed to avoid dust on the lens.
- The lens may cloud over when the player is suddenly moved from cold to warm surroundings. It is then not possible to play a CD/DVD. Leave the player in a warm environment until the moisture evaporates.

## INTRODUCTION

### About Built-in Rechargeable Battery

#### Precautions related to battery recharge

- 1 Once the battery is fully discharged, immediately recharge it (regardless of whether you plan to use the battery or not) in order to maximize the battery life. When the power is low, the battery icon will be shown on the upper-right corner of the TFT for warning.
- 2 To charge the battery, please directly connect this DVD player to AC mains and the charge indicator will turn on.

#### Using and maintaining your rechargeable batteries

- 1 Please make sure you always use only the AC adapter included with the player to recharge your batteries.
- 2 Recharge efficiency will degrade when the environmental temperature drops below 50°F (10°C) or exceed 95°F (35°C).
- 3 The lasting time of the fully charged battery when a headphone is connected to the DVD player is approximately 2.5 hours.

### Playable disc formats

In addition to DVD-Video disc, you will also be able to play all Video CDs and audio CDs (including CD-R, CD-RW, DVD±R and DVD±RW).

### DVD-Video

Depending on the material on the disc (a movie, video clips, a drama series, etc.) these discs may have one or more Titles, and each Title may have one or more Chapters. To make access easy and convenient, your player lets you move between Titles, and also between Chapters.

### CD with JPEG files

You can also view JPEG still photos on this player.



## Video CD

Depending on the material on the disc (a movie, video clips, a drama series, etc.) these discs may have one or more Tracks, and tracks may have one or more indexes, as indicated on the disc case. To make access easy and convenient, your player lets you move between tracks and between indexes.

## Audio CD / MP3 CD

Audio CDs / MP3-CD contain music tracks only. You can play them in the conventional way through a stereo system using the keys on the remote control and/or main unit, or via the TV using the On Screen Display (OSD).

## About DivX

DivX is a popular media technology created by DivX, Inc. DivX media files contain highly compressed video with high visual quality that maintains a relatively small file size. DivX files can also include advanced media features like menus, subtitles, and alternate audio tracks. Many DivX media files are available for download online, and you can create your own using your personal content and easy-to-use tools from [www.DivX.com](http://www.DivX.com).

## About SD Memory Card

SD Memory Card is a slim and compact bridge media linking various kinds of digital equipment through its easy connectivity. The card's control circuitry allows data to be read and written (in its protection area) only when appropriate external devices are detected. Using decoder software, an SD Memory Card-compatible device can play music, video clips and more without a drive mechanism like those in CD and DVD players.



## Power Sources

This unit operates on a supplied AC adaptor, car adaptor, or the built-in lithium battery.

- Make sure that the input voltage of the AC adaptor is in line with the local voltage. Otherwise, the AC adaptor and unit may be damaged.
- Do not touch the AC adaptor with wet hands to prevent electric shock.
- When connecting with car power (cigarette lighter) adaptor, be sure the input voltage of the adaptor is identical with car voltage.
- Unplug the AC adaptor from the outlet when the unit is not used for long periods of time.
- Hold the plug to disconnect the AC adaptor. Do not pull the power cord.

## Safety and maintenance

- Do not disassemble the unit for laser rays are dangerous to eyes. Any service should be done by qualified service personnel.
- Unplug the AC adaptor to cut the power if liquid or objects get inside the unit.
- Take care not to drop the unit or subject it to strong shocks, which may cause malfunction.
- Important (for models with by-packed headphones): Philips guarantees compliance with the maximum sound power of its audio players as determined by relevant regulatory bodies only with the original model of provided headphones. In case this one needs replacement, we recommend that you contact your retailer to order a model identical to that of the original provided by Philips.
- Traffic safety: do not use while driving or cycling as you may cause an accident
- Do not expose to excessive heat caused by heating equipment or direct sunlight.
- This product is not waterproof: do not allow your player to be submersed in water. Water entering the player may cause major damage.
- Do not use any cleaning agents containing alcohol, ammonia, benzene, or abrasives as these may harm the player.
- Apparatus shall not be exposed to dripping or splashing. Do not place any sources of danger on the apparatus (e.g. liquid filled objects, lighted candles)
- Do not touch the lens!

*Note: When the player is in use for a long period of time, the surface will be heated. This is normal.*

## GENERAL INFORMATION

### Hearing Safety

#### Listen at a moderate volume:

- Using headphones at a high volume can impair your hearing. This product can produce sounds in decibel ranges that may cause hearing loss for a normal person, even for exposure less than a minute. The higher decibel ranges are offered for those that may have already experienced some hearing loss.
- Sound can be deceiving. Over time your hearing "comfort level" adapts to higher volumes of sound. So after prolonged listening, what sounds "normal" can actually be loud and harmful to your hearing. To guard against this, set your volume to a safe level before your hearing adapts and leave it there.



#### To establish a safe volume level:

- Set your volume control at a low setting.
- Slowly increase the sound until you can hear it comfortably and clearly, without distortion.

#### Listen for reasonable periods of time:

- Prolonged exposure to sound, even at normally "safe" levels, can also cause hearing loss.
- Be sure to use your equipment reasonably and take appropriate breaks.

#### Be sure to observe the following guidelines when using your headphones:

- Listen at reasonable volumes for reasonable periods of time.
- Be careful not to adjust the volume as your hearing adapts.
- Do not turn up the volume so high that you can't hear what's around you.
- You should use caution or temporarily discontinue use in potentially hazardous situations.
- Do not use headphones while operating a motorized vehicle, cycling, skateboarding, etc.; it may create a traffic hazard and is illegal in many areas.

## GENERAL INFORMATION

### Handling discs

- Do not attach paper or tape to the disc.
- Keep the disc away from direct sunlight or heat sources.
- Store the disc in a disc case after playback.
- To clean, wipe the disc outwards from the center with a soft, lint-free clean cloth.



### On handling the LCD screen

The LCD is manufactured using high precision technology. You may, however, see tiny black points and/or bright points (red, blue, green) that continuously appear on the LCD. This is a normal result of the manufacturing process and does not indicate a malfunction.

### Environmental information

We have reduced the packaging to its minimum and made it easy to separate into mono materials: cardboard, PS, PE and PET.

Your set consists of material which can be recycled if disassembled by a specialized company. Please observe the local regulations to dispose of packaging, exhausted batteries and old equipment.

### Copyright information

"DivX, DivX" Certified, and associated logos are trademarks of DivX, Inc. and are used under license."

All other brand and product names are trademarks of their respective companies or organizations.

Unauthorized duplication of any recordings downloaded from the internet or made from CDs / VCDs / DVDs is a violation of copyright laws and international treaties.

Dolby Information: Manufactured under license from Dolby Laboratories. "Dolby" and the double-D symbol are trade marks of Dolby Laboratories.



## PREPARATIONS

### Power supply

#### Using the AC / DC adaptor

Connect the supplied adaptor to the set and the main power supply (as shown).



TIP

To avoid damage to the player, switch off before plugging or unplugging the AC adaptor.

#### Using the car adaptor

Connect the supplied car adaptor to the set and the car cigarette lighter outlet.



TIP

- To avoid damage to the player, switch off before plugging or unplugging the car adaptor.
- When connecting with car power (cigarette lighter) adaptor, be sure the input voltage of the adaptor is identical with car voltage.
- Make sure the temperature is below 35°C when the DVD player is connected to DC 16.0V in a car.

### Powering your remote control

- 1 Open the battery compartment. Remove the protective plastic tab (first time users only).
- 2 Insert 1 x lithium 3V battery, type CR2025, then close the compartment.

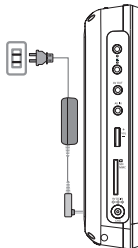

### CAUTION

- Batteries contain chemical substances, so they should be disposed of properly.
- Danger of explosion if battery is incorrectly replaced. Replace only with the same or equivalent type.
- Incorrect use of batteries can cause electrolyte leakage and will corrode the compartment or cause the batteries to burst.

## PREPARATIONS

- Remove the battery if the remote control is not to be used for a long time.

### Connections

#### Connecting headphones

Connect the headphones into the **1** or the **2** jack of your set.

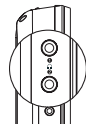

#### Connecting additional equipment

- Turn off your set before connecting to any additional equipment.
- You can connect the player to a TV or an amplifier to enjoy DVDs or karaoke.

### AV OUT

Connect the desired device to this terminal directly (no setting needed in the DVD, iPod or SD/MMC mode).

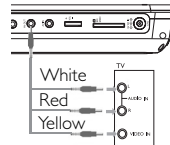

### AV IN

On the DVD player panel, press the source key repeatedly (**AV** on the remote) to select AV IN (AUX).

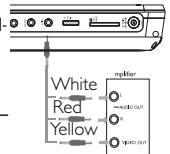

Connection Color	Video	Audio (Left)	Audio (Right)
White		White	Red
Red			
Yellow	Yellow		

## PREPARATIONS

### SD/MMC card slot

You can play video/audio/picture files stored in an SD/MMC card by inserting it into the **SD/MMC CARD** slot.

On the DVD player panel, press the **SOURCE** key repeatedly (or **SD/MMC CARD** on the remote) to select the SD/MMC source.



TIP

Make sure the metal contact of the card to be inserted is facing down.



### Dock for iPod

You can dock your iPod player for playback of stored files and recharging. iPod classic, nano and touch are supported.

### Connecting the iPod player

- 1 Press **iPod** to switch to iPod mode.  
→ "Please connect the iPod" is displayed.



- 2 Push the **iPod EJECT** key to eject the dock for iPod.

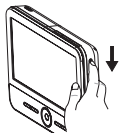

## PREPARATIONS

- 3 Pull the dock out.

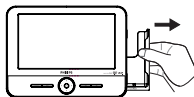

- 4 Put your iPod player in the dock.

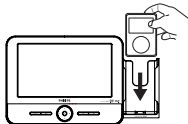

→ "Connecting to iPod" is displayed. The certification will take about three seconds.

→ After certification is complete, the display on the DVD and iPod players is as follows:



### Removing the iPod player

Remove the iPod player as shown.

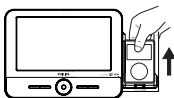

### About this manual

This manual gives the basic instructions for operating this DVD player. Some DVD discs however are produced in a way that requires specific operation or allows only limited operation during playback. In these cases the player may not respond to all operating commands. When this occurs, please refer to the instructions in the disc inlay. When a "✖" appears on the screen, the operation is not permitted by the player or the disc.

### Remote control operation

- Unless otherwise stated, all operations can be carried out with the remote control. Always point the remote control directly at the player, making sure there are no obstructions in the path of the infrared beam.
- When there are corresponding keys on the main unit, they can also be used.

### Menu navigation

- Your player has an intuitive menu navigation system to guide you through various settings and operations.
- Use the function keys to activate / disable relevant operations.
- Use ▲, ▼, ◀, ▶ to browse through menus.
- Press the **OK** key to confirm your selection.

### Switching on for OSD language setup

English is the default language of your player's on screen display. You may choose to use English, French or Spanish for your player's on screen display.

Country	OSD Language Options
Europe	English, French, Spanish

- 1 Press **ON** briefly to switch on the player.
- 2 Press **SETUP** for the setup menu.
- 3 Select **Language** and press ▼.
- 4 Select **OSD** and press ▶ to select from OSD language options.
- 5 Select your preferred language and press **OK**.

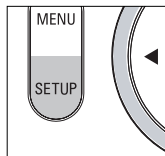

### Loading discs and switching on

- 1 Push **OPEN** to open the disc door.
- 2 Insert your chosen disc, label side up (also when a double sided DVD disc is inserted). Make sure it is sitting properly in the correct recess.
- 3 Gently push to close the door.
- 4 Slide the **POWER** switch to **ON** to switch on the player.



TIP

A normal mechanical noise is heard during playback.

## BASIC FUNCTIONS

## Playing a DVD disc

After switching on, inserting the disc and closing the door, playback starts automatically. The screen shows the type of disc loaded. The disc may invite you to select an item from a menu. Use the ▲, ▼, ◀, ▶ keys to highlight your selection, and press **OK**.

*Note: Since it is usual for DVD movies to be released at different times in different regions of the world, all players have region codes and discs can have an optional region code. If you load a disc of a different region code to your player, you will see the region code notice on the screen. The disc will not play, and should be unloaded.*

## Playing an audio or video CD disc

- After switching on, inserting the disc and closing the door, playback starts automatically. The screen shows the type of disc loaded as well as information about the disc's contents.
- While playing VCD with MTV/Karaoke, press number keys (0-9) to select the track and press ▶|| or **OK** to play the track. Press **TITLE/RETURN** to go back to menu of the selection.

## Playing DivX® disc

- Philips provide you the DivX® VOD (Video on Demand) registration code that allows you to rent and purchase videos using the DivX® VOD service. For more information, visit [www.divx.com/vod](http://www.divx.com/vod).
- Select the DivX® VOD on the Custom Page.
- The registration code will appear.
- Use the registration code to purchase or rent the videos from DivX® VOD service at [www.divx.com/vod](http://www.divx.com/vod). Follow the instructions and download the video onto a CD-R for playback on this DVD player.



TIP

All the downloaded videos from DivX® VOD can only be played back on this DVD player.

## BASIC FUNCTIONS

## Playing an MP3 CD

The following playback features are available for MP3 CDs. Please refer to the corresponding sections for more information.

Volume control, skipping tracks, searching, repeat, shuffle, etc.

Use the ▲, ▼ keys to highlight your selected music folder. Press **OK** to play.

## Playing a JPEG disc

Use the ▲, ▼ keys to highlight your selected picture. Press **OK**. The player will then automatically enter the slide show mode.

During playback, you can:

- Use ◀, ▶ to rotate the picture.
- Use ▲ to flip left/right.
- Use ▼ to flip up/down.
- Press **MENU** to go back to folder screen.
- Press ■ to go to group preview.
- Press **ZOOM** repeatedly to display the picture with different scales.
- Use ▲, ▼, ◀, ▶ to view the zoomed picture (for picture zoomed in only).

## BASIC FUNCTIONS

### Playing files stored in an SD/MMC card

After connecting an SD/MMC card to this player, you can play audio/video files stored in the card by selecting the desired file with ▲ ▼ and **OK**.

### Playing files stored in your iPod player

After connecting your iPod player as described in the "Connections" section, you can play files stored in the iPod player with keys on your iPod player or the following keys on the remote control of your DVD player directly.

<b>OK</b>	Confirm a selection.
<b>▶  </b>	Start or interrupt playback.
<b>◀/▶</b>	Search backward/forward.
<b>◀◀ / ▶▶</b>	Skip to the previous/next track.
<b>■</b>	Stop playback.
<b>MENU</b>	Exit the menu.
<b>▲/▼</b>	Select an item in a menu.
<b>REPEAT</b>	Select repeat function (repeat one/all/off is available).
<b>SHUFFLE</b>	Select shuffle function (shuffle all/album/off is available).



TIP

- To recharge your iPod player, you must connect your DVD player to AC mains (or the car cigarette lighter outlet) and ensure: Your DVD player is in the power-off mode; OR, the DVD player is in the power-on mode and the current source is "iPod".
- Once the battery is running low, immediately recharge it (regardless of whether you plan to use the battery or not) in order to maximize the battery life.
- It is impossible to recharge your iPod with the built-in battery of the DVD player.
- Make sure to recharge your iPod player below 35°C.

## GENERAL FEATURES

### Moving to another title / track / chapter

When a disc has more than one title or track, you can move to another title/track/chapter as follows:

- Press **▶▶** briefly during play to select the next title/ track / chapter.
- Press **◀◀** briefly during play to step back to the previous title/track/chapter.
- To go directly to any title, track or chapter, enter the corresponding number using the numerical keys (0-9).

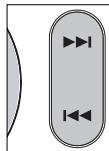

### Search

During playback, press **▶** repeatedly for the following forward search options:  
Press **◀** repeatedly for the following backward search options:

<b>◀</b>	<b>▶</b>
2 X backwards	2 X forward
4 X backwards	4 X forward
8 X backwards	8 X forward
16 X backwards	16 X forward
32 X backwards	32 X forward
normal speed	normal speed

Press **OK** or **▶||** to resume normal playback.

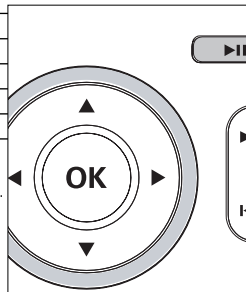

## GENERAL FEATURES

## Changing the audio output (for VCD/CD)

Press **AUDIO** repeatedly for the following audio options.

x 1	Mono left	x 2	Mono right
x 3	Stereo		



TIP

This key is used to select audio languages during DVD playback.

## ZOOM

The Zoom function allows you to enlarge the video image and to pan through the enlarged image. Press **ZOOM** repeatedly to select the following zooming options.

Zoom x 1	2X	Zoom x 2	4X
Zoom x 3	Normal		

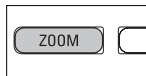

TIP

During JPEG operation, the sequence is 100%, 150%, 200%, 25%, 50% and normal.

## REPEAT

Press **REPEAT** repeatedly for the following repeat options:

	DVD actions	MP3 actions	CD actions	JPEG/DivX actions
x 1	repeats chapter	repeats one	repeats track	repeats one
x 2	repeats title	repeats folder	repeats all	repeats folder
x 3	repeats all	Cancels repeat	Cancels repeat	Cancels repeat
x 4	Cancels repeat			

## GENERAL FEATURES



TIP

The repeat function is also available for JPEG, SD/MMC etc. The actions may vary for different media being played.

## SHUFFLE

Press **SHUFFLE** on the remote to play all tracks (for CD), chapters (for DVD) or all tracks in the selected folder/whole disc (for MP3) randomly.

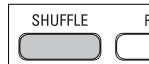

## Repeat A - B

To repeat or loop a sequence in a title:

- Press **A - B** at your chosen starting point;
  - ↻ **A** appears on the screen.
- Press **A - B** again at your chosen end point;
  - ↻ **AB** appears on the display, and the repeat sequence begins.
- To exit the sequence, press **A - B**.

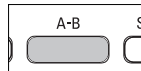

## Volume Control

- Use the rotatory switch on the left side of the unit to increase or decrease playback volume.

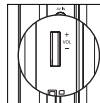

## GENERAL FEATURES

### MONITOR (on the main unit)

Press **MONITOR** repeatedly to adjust the display mode (normal or full screen).

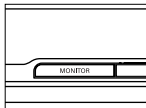

### DISPLAY

Press **DISPLAY** on the remote repeatedly for the following display options:

	DVD
x 1	Title elapsed
x 2	Title remained
x 3	Chapter elapsed
x 4	Chapter remained
X5	Disc information
X6	Display off



TIP

During JPEG operation, pressing this button enables you to select 17 slideshow modes.

### PROGRAM

- 1 During playback, press **PROG** on the remote to enter a program menu.
- 2 Use the **numerical keys 0-9** to directly input the tracks or chapters (single track number with digit "0" in front, for example "05").
- 3 Move the cursor by pressing to select **START** and then press **OK** to start program playback.

## SPECIAL DVD FEATURES

Checking the contents of DVD-Video discs: **MENU**.

For titles and chapters, selection menus may be included on the disc. The DVD's menu feature allows you to make selections from these menus. Press the appropriate numerical key; or use the **▲, ▼, ◀, ▶** keys to highlight your selection, and press **OK**.

### Disc menu

Press **MENU**. The menu may list, for example, camera angles, spoken language and subtitle options, and chapters for the title.

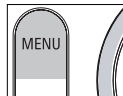

### Changing the language

Press **AUDIO**. If the current disc has different language options, this now appears on the screen.

Press **AUDIO** repeatedly until you have reached your desired language option.



### Subtitle

Press **SUBTITLE**. If the current disc has different subtitles options, this now appears on the screen.

Press **SUBTITLE** repeatedly until you have reached your desired subtitles option.

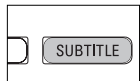

TIP

The above two features depend on whether your disc contains any language or subtitle options.

## SPECIAL DVD FEATURES

## Playing a title

- 1 Press **MENU** to enter the disc title menu.
- 2 Use **▲, ▼, ◀, ▶** or **numeric keys (0-9)** to select a play option.
- 3 Press **OK** to confirm.

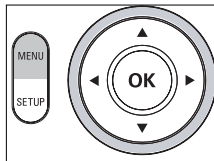

## SETUP OPERATIONS

To maximize your playback experience, use **SETUP** to fine tune your settings. Use the **▲, ▼, ◀, ▶** keys to highlight your selection, and press **OK**.

- 1 Press **SETUP**. A list of features is shown.
- 2 Use the **▲ ▼** keys to highlight your selection.

When the cursor highlights these settings, press **OK** to:

Language	select language options
Screen	select screen options
Photo	select photo options
Custom	select custom options
Exit	exit the system menu

- 3 Press **◀** to abort current settings or go back to previous menu level.
- 4 Press **SETUP** to exit.

## Language

When the cursor highlights these settings, press **OK** to:

On Screen Display	select on-screen display language
Menu	select disc menu language options
Audio	select disc audio language options
Subtitle	select disc subtitle language options

Press **◀** to abort current settings or go back to previous menu level.



## SETUP OPERATIONS

### Screen

When the cursor highlights these settings, press **OK** to:

Display Type	select display ratio
Brightness	select brightness level
Contrast	select contrast level

Press **◀** to abort current settings or go back to previous menu level

### Photo

When the cursor highlights these settings, press **OK** to:

Slide Show Frequency	set the time between two photos
Slide Show Effect	select 17 slideshow modes
Display Format	switch between Normal and Widescreen
Photo Display	switch between Slide Show and Browse

Press **◀** to abort current settings or go back to previous menu level

### Custom

When the cursor highlights these settings, press **OK** to:

Parental Control	select parental options
DivX® VOD	get DivX ID for VOD
Password	change existing password (3308 by default)
Angle Mark	select angle mark display options
Default	restore factory settings

Press **◀** to abort current settings or go back to previous menu level.

*Note: Before using the ▲▼ keys to select your desired angle mark, ensure the disc has been recorded with angle mark and you have enabled the angle mark option in the system menu.*

## TROUBLESHOOTING

If it appears that the DVD-Video player is faulty, first consult this checklist. It may be that something has been overlooked.

### WARNING

**Under no circumstances should you try to repair the set yourself as this will invalidate the guarantee.**

**If a fault occurs, first check the points listed, before taking the set for repair. If you are unable to solve a problem by following these hints, consult your dealer or service centre.**

### Symptom

### Remedy

#### No power

- Check if both plugs of the mains cord are properly connected.
- Check if there is power at the AC outlet by plugging in another appliance.
- Check if the built-in battery is drained.
- Check if car adaptor is connected appropriately.

#### Distorted picture

- Check the disc for fingerprints and clean with a soft cloth, wiping from centre to edge.
- Sometimes a small amount of picture distortion may appear. This is not a malfunction.

#### Completely distorted picture / no colour in the TV screen

- The PAL setting may be in the wrong status. Match your TV's setting with the player's setting.

#### No sound

- Check audio connections. If using a HiFi amplifier, try another sound source.

## TROUBLESHOOTING

Symptom	Remedy
<b>Disc can't be played</b>	<ul style="list-style-type: none"> <li>– Ensure the disc label is upwards.</li> <li>– Clean the disc.</li> <li>– Check if the disc is defective by trying another disc</li> </ul>
<b>The player does not respond to the remote control</b>	<ul style="list-style-type: none"> <li>– Aim the remote control directly at the sensor on the front of the player. Avoid all obstacles that may interfere with the signal path. Inspect or replace the batteries.</li> </ul>
<b>Distorted or B/W picture with DVD</b>	<ul style="list-style-type: none"> <li>– Use only discs formatted according to the TV-set used (NTSC).</li> </ul>
<b>Player does not respond to all operating commands during playback</b>	<ul style="list-style-type: none"> <li>– Operations are not permitted by the disc.</li> <li>– Refer to the instructions in the disc inlay.</li> </ul>
<b>Player feels warm</b>	<ul style="list-style-type: none"> <li>– When the player is in use for a long period of time, the surface will be heated. This is normal.</li> </ul>
<b>Display goes dimmer when AC is unplugged</b>	<ul style="list-style-type: none"> <li>– The unit is saving power to ensure longer playtime with battery. It is normal. Adjust the brightness using the rotary brightness control.</li> </ul>

*This set complies with the radio interference requirements of the European Union.*

## TECHNICAL DATA

Dimensions	235 x 178 x 40 mm
Weight	909 g
Power supply	DC 9V 1.0A
Power Consumption	9W
Operating temperature range	0 - 45°C
Laser wavelength	650nm
Video system	NTSC
Frequency response	20Hz ~ 20KHz ± 1dB
Signal/noise ratio	≥ 80dB
Audio distortion + noise	≤ -80(1KHz)
Channel separation	≥ 80dB
Dynamic range	≥ 80dB
Output	
Audio out (analog audio)	Output level: 2V ± 10%
Load impedance:	10KΩ
Video out Output level:	1Vp - p ± 20%
Load impedance:	75Ω

**PHILIPS reserves the right to make design and specification changes for product improvement without prior notice.**

**Modifications not authorized by the manufacturer may void users authority to operate this device.**

**All rights reserved.**

## DISPOSAL OF YOUR OLD PRODUCT

Your product is designed and manufactured with high quality materials and components, which can be recycled and reused.



When this crossed-out wheeled bin symbol is attached to a product it means the product is covered by the European Directive 2002/96/EC.

Please inform yourself about the local separate collection system for electrical and electronic products.

Please act according to your local rules and do not dispose of your old products with your normal household waste. The correct disposal of your old product will help prevent potential negative consequences for the environment and human health.

This product incorporates copyright protection technology that is protected by method claims of certain U.S. patents and other intellectual property rights owned by Macrovision Corporation and other rights owners. Use of this copyright protection technology must be authorized by Macrovision Corporation, and is intended for home and other limited viewing uses only unless otherwise authorized by Macrovision Corporation. Reverse engineering or disassembly is prohibited.



Need help?

**Online**

Go to [www.philips.com/support](http://www.philips.com/support)



**Be responsible  
Respect copyrights**

© Royal Philips Electronics N.V. 2008

Meet Philips at the Internet  
<http://www.philips.com>

