

DVDVIDEO / SACD PLAYER



**PHILIPS**

## General Information

### Environmental Information

All unnecessary packaging has been omitted. The packaging has been made easy to separate into three materials: cardboard (box), polystyrene foam (buffer) and polyethylene (bags, protective foam sheet).

Your DVD player consists of materials which can be recycled and reused if disassembled by a specialised company. Please observe the local regulations regarding the disposal of packaging materials, exhausted batteries and old equipment.

The apparatus shall not be exposed to dripping or splashing and that no objects filled with liquids, such as vases, shall be placed on apparatus.

'CONSUMERS SHOULD NOTE THAT NOT ALL HIGH DEFINITION TELEVISION SETS ARE FULLY COMPATIBLE WITH THIS PRODUCT AND MAY CAUSE ARTIFACTS TO BE DISPLAYED IN THE PICTURE. IN CASE OF 525 OR 625 PROGRESSIVE SCAN PICTURE PROBLEMS, IT IS RECOMMENDED THAT THE USER SWITCH THE CONNECTION TO THE 'STANDARD DEFINITION' OUTPUT. IF THERE ARE QUESTIONS REGARDING OUR TV SET COMPATIBILITY WITH THIS MODEL 525p AND 625p DVD PLAYER, PLEASE CONTACT OUR CUSTOMER SERVICE CENTER.'

#### For Customer Use:

Read carefully the information located at the bottom of your DVD VIDEO player and enter below the Serial No. Retain this information for future reference.

Model No. DVD VIDEO 720SA  
Serial No. \_\_\_\_\_

### Laser safety

This unit employs a laser. Due to possible eye injury, only a qualified service person should remove the cover or attempt to service this device.

**NOTE:**  
**PICTURES SHOWN MAYBE DIFFERENT BETWEEN COUNTRIES.**

**CAUTION**  
**(WARNING LOCATION: ON THE BACKPLATE OF THE SET)**

**NEVER MAKE OR CHANGE CONNECTIONS WITH THE POWER SWITCHED ON.**

#### Important Note:

*Due to the numerous versions of new CD-Audio copy protection or enhanced CD-Audio protection recently available on certain discs, Philips is unable to guarantee that this DVD Player is fully compatible with such new discs. Should you have difficulty playing any such CD-Audio discs, kindly refer them to your CD-Audio disc retailer.*

DivX, DivX Certified, and associated logos are trademarks of DivX Networks, Inc and are used under license.



#### LASER

Type	Semiconductor laser GaAlAs
Wave length	650 nm (DVD) 780 nm (VCD/CD)
Output Power	7 mW (DVD) 10 mW (VCD/CD)
Beam divergence	60 degree

## Index

English .....	6
中文(简体) .....	35
中文(繁體) .....	65
Bahasa Melayu .....	95

English

中文(简体)

中文(繁體)

Bahasa Melayu

“DTS”, and “DTS Digital Surround” are registered trademarks of Digital Theater Systems, Inc.

*This product incorporates copyright protection technology that is protected by method claims of certain U.S. patents and other intellectual property rights owned by Macrovision Corporation and other rights owners. Use of this copyright protection technology must be authorized by Macrovision Corporation, and is intended for home and other limited viewing uses only unless otherwise authorized by Macrovision Corporation. Reverse engineering or disassembly is prohibited.*

*Manufactured under license from Dolby Laboratories. “Dolby”, “Pro-Logic” and the double-D symbol are trademarks of Dolby Laboratories.*

Due to the inconsistency of disc formats provided by various disc manufacturers, your DVD system may require a playability enhancement or upgrade. As DVD technology advances, these enhancements will become common and will be easy to complete.  
**Go to [www.p4c.philips.com](http://www.p4c.philips.com) for software upgrade.**

## Contents

### Introduction

Supplied accessories .....	5
Care and safety information .....	5

### Connections

Connecting TV .....	6-7
Using Composite Video jacks (CVBS) .....	6
Using S-Video jack .....	6
Using Component Video jacks (Pr Pb Y) ...	7
Using an accessory RF modulator .....	7
Connecting the power cord .....	8
Optional: Connecting to a Multi-channel Receiver .....	8
Receiver has a Dolby Digital or DTS decoder .....	8
Optional : Connecting to an Audio System ...	9
Stereo system has Dolby Pro Logic or Right / Left Audio In jack .....	9
Optional: Connecting Digital AV Receiver .....	9
Receiver has a PCM, Dolby Digital, or MPEG2 decoder .....	9

### Functional Overview

Front and Rear Panels .....	10
Remote Control .....	11

### Getting Started

Step 1: Inserting batteries into the Remote Control .....	12
Using the Remote Control to operate the Player .....	12
Step 2: Setting up the TV .....	12-13
To deactivate Progressive manually ...	12-13
Selecting the colour system that corresponds to your TV .....	13
Step 3: Setting language preference .....	14
Setting the OSD Language .....	14
Setting the Audio, Subtitle and Disc menu language .....	14
Step 4: Setting the speakers' channels .....	15

### Disc Operations

Playable Discs .....	16
Region Codes .....	16
Playing discs .....	16
Basic playback controls .....	17
Selecting various repeat/shuffle functions ..	17
Repeat play mode .....	17
Repeating a section within a chapter/track ...	17
Operations for video playback .....	18
Using the Disc Menu .....	18
Zooming in .....	18
Resuming playback from the last stopped point .....	18

Using the OSD menu .....	18
Special DVD features .....	19
Playing a Title .....	19
Camera Angle .....	19
Changing the Audio Language .....	19
Subtitles .....	19
Special VCD & SVCD Features .....	19-20
Playback Control (PBC) .....	19
Preview Function .....	20
Playing MP3/DivX/MPEG-4/JPEG/Kodak Picture CD .....	20-21
General Operation .....	20
Selecting a folder and track/file .....	21
Playing Super Audio CD (SACD) .....	21
Special picture disc features .....	22
Preview Function .....	22
Zoom picture .....	22
Playback with multi-angles .....	22
Scan Effect .....	22
Playing MP3 music and JPEG picture simultaneously .....	22

### DVD Menu Options

General Setup menu .....	23-24
Locking/Unlocking the disc for viewing ...	23
Dimming system's display screen .....	23
Programming disc tracks .....	23-24
Screen Saver - turning on/off .....	24
DivX(R) VOD registration code .....	24
Audio Setup Menu .....	24-25
Digital Audio Setup .....	25
Setting the analogue output .....	25
Speaker Setup .....	25
CD Upsampling .....	25
Night Mode - turning on/off .....	26
Video Setup Menu .....	26-27
TV Type .....	26
Setting the TV Display .....	26
Progressive - turning on/off .....	27
Picture Setting .....	27-28
Preference Page .....	28-29
Audio, Subtitle, Disc Menu .....	28
Restricting playback by Parental Control ...	29
PBC .....	29
MP3/JPEG Menu - turning on/off .....	29
Changing the Password .....	30
Setting the DivX Subtitle .....	30
Restoring to original settings .....	30

### Specifications .....

### Troubleshooting .....

### Glossary .....

## General Information

### Supplied accessories

Video cable  
(yellow)



Audio cable  
(white, red)

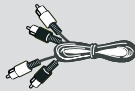

Remote Control  
and  
two AA batteries

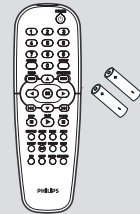

### Care and safety information

- **Power consumption**
  - Check that the operating voltage indicated on the typeplate (or beside the voltage selector) is identical to the voltage of your local power supply. If not, please consult your dealer.
  - When the system is switched to Standby mode, it is still consuming power. To disconnect the system from the power supply completely, remove the AC power plug from the wall jack.

- **Avoid high temperatures, moisture, water and dust**
  - Do not expose the player, batteries or discs to humidity, rain, sand or excessive heat (caused by heating equipment or direct sunlight.)
- **Avoid condensation problem**
  - The lens may cloud over when the player is suddenly moved from cold to warm surroundings, making it impossible to play a disc. Leave the player in the warm environment until the moisture evaporates.
- **Do not block the vents**
  - Do not operate the DVD Player in an enclosed cabinet, allow about 2.5 cm (1 inches) of free space all around the player for adequate ventilation.

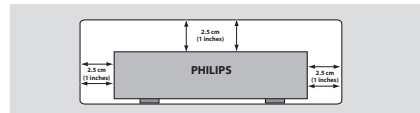

- **Care of the cabinet**
  - Use a soft cloth slightly moistened with a mild detergent solution. Do not use a solution containing alcohol, spirits, ammonia or abrasives.
- **Finding a suitable location**
  - Place the player on a flat, hard, and stable surface.
- **Disc handling**
  - To clean a CD, wipe it in a straight line from the center towards the edge using a soft, lint-free cloth. A cleaning agent may damage the disc!
  - Write only on the printed side of a CDR(W) and only with a soft felt-tipped pen.
  - Handle the disc by its edge, do not touch the surface.

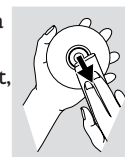

## Connections

### Connecting TV

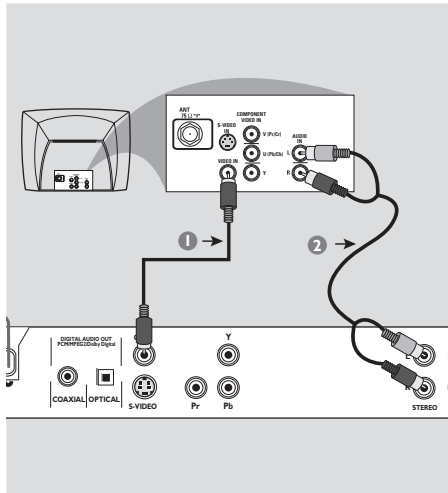

#### IMPORTANT!

- You only need to make one video connection from the following options, depending on the capabilities of your TV system.
- Connect the DVD system directly to the TV.

#### Using Composite Video jacks (CVBS)

- 1 Use the composite video cable (yellow) to connect the DVD Player's CVBS (VIDEO) jack to the video input jack (or labeled as A/V In, Video In, Composite or Baseband) on the TV (*cable supplied*).
- 2 To hear the sound of this DVD Player through your TV, use the audio cables (white/red) to connect AUDIO OUT (L/R) jacks of the DVD Player to the corresponding AUDIO IN jacks on the TV (*cable supplied*).

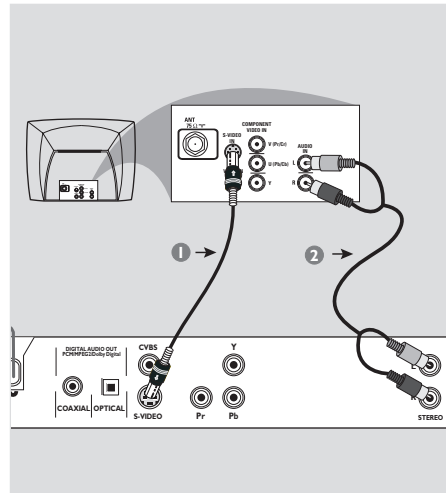

#### IMPORTANT!

- S-Video connection provides better picture quality. This option must be available on your TV.

#### Using S-Video jack

- 1 Use the S-video cable to connect the DVD system's **S-VIDEO OUT** jack to the S-Video input jack (or labeled as Y/C or S-VHS) on the TV (*cable not supplied*).
- 2 To hear the sound of this DVD Player through your TV, use the audio cables (white/red) to connect AUDIO OUT (L/R) jacks of the DVD Player to the corresponding AUDIO IN jacks on the TV (*cable supplied*).

## Connections

English

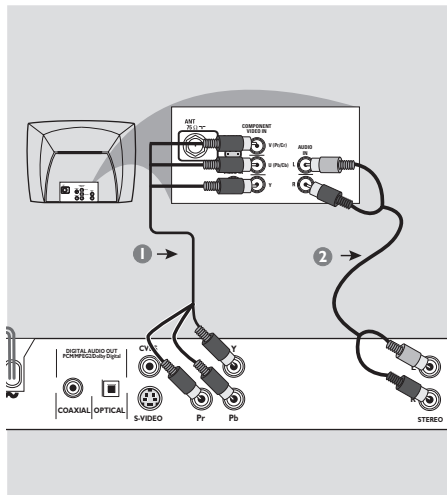

### IMPORTANT!

- Component Video connection provides higher picture quality. This option must be available on your TV.
- The progressive scan video quality is only possible through Component Video (Y Pb Pr) output.

#### Using Component Video jacks (Y Pb Pr)

- 1 Use the component video cables (red/blue/green) to connect the DVD system's **Y Pb Pr** jacks to the corresponding Component video input jacks (or labeled as **Y Pb Pr**) on the TV (*cable not supplied*).
- 2 To hear the sound of this DVD Player through your TV, use the audio cables (white/red) to connect AUDIO OUT (L/R) jacks of the DVD Player to the corresponding AUDIO IN jacks on the TV (*cable supplied*).

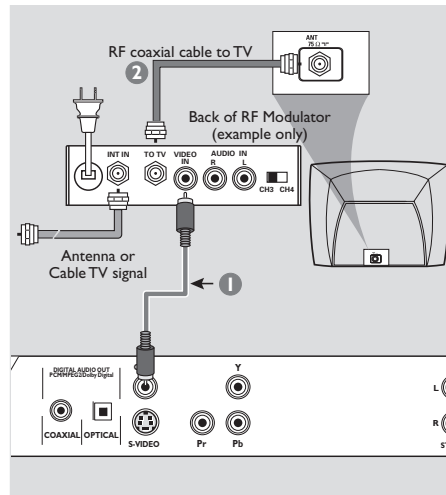

### IMPORTANT!

- If your TV only has a single Antenna In jack (or labeled as 75 ohm or RF In,) you will need an RF modulator in order to view the DVD playback on the TV. See your electronics retailer or contact Philips for details on RF modulator availability and operations.

#### Using an accessory RF modulator

- 1 Use the composite video cable (yellow) to connect the DVD Player's **CVBS** jack to the video input jack on the RF modulator.
- 2 Use the RF coaxial cable (not supplied) to connect the RF modulator to your TV's RF jack.

## Connections

### Connecting the power cord

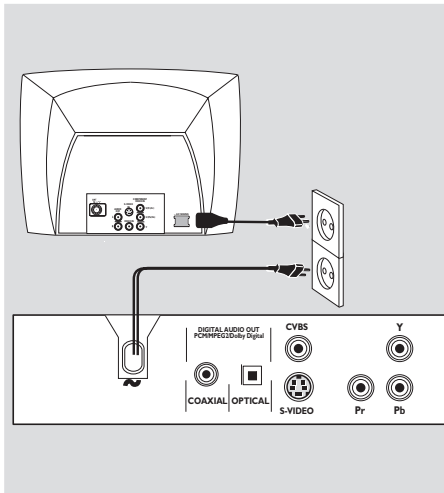

After everything is connected properly, plug in the AC power cord to the power outlet.

Never make or change any connections with the power switched on.

When no disc is loaded, press **STANDBY ON** on the DVD Player front panel, "NO DISC" may appear on the display panel.

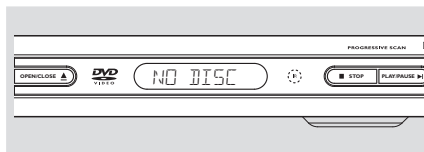

### Optional: Connecting to a Multi-channel Receiver

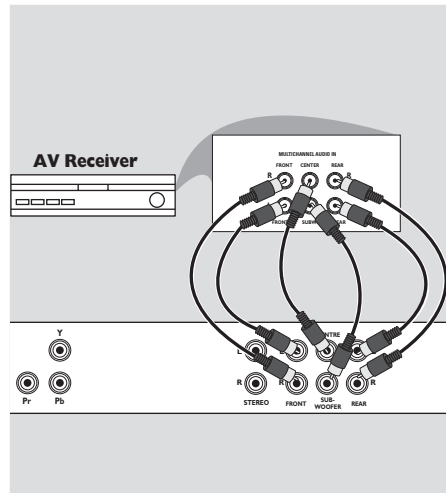

#### Receiver has a Dolby Digital or DTS decoder

- 1 Select one of the video connections (CVBS VIDEO IN, S-VIDEO IN, SCART, COMPONENT VIDEO IN) depending on the options available on your TV.
- 2 Connect the Audio Out Left and Right jack for Front and Rear speakers to the corresponding input sockets on your Receiver (cable supplied).
- 3 Connect the Audio Out for Center speaker and Subwoofer to the corresponding inputs on your Receiver (cable not supplied).
- 4 Set the DVD Player's Analog Output to 'Multichannel' to enable playback of DVDs recorded in Multi-channel. (see page 25 "Setting the analogue output").

#### Helpful Hint:

- If the subwoofer is equipped with its own amplifier, the Subwoofer connection should be connected directly to the subwoofer.



## Connections

English

### Optional: Connecting to an Audio System

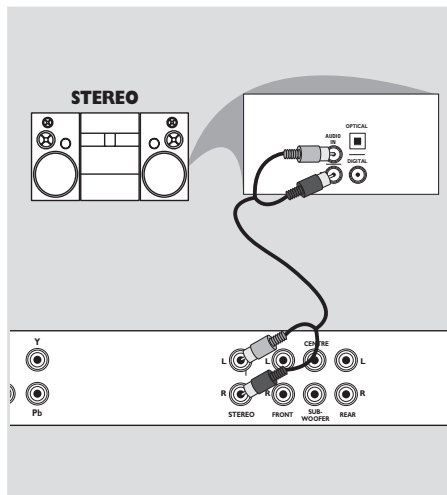

#### Stereo system has Dolby Pro Logic or Right / Left Audio In jack

- 1 Select one of the video connections (CVBS VIDEO IN, S-VIDEO IN, SCART, COMPONENT VIDEO IN) depending on the options available on your TV.
- 2 Use the audio cables (white/red) to connect **AUDIO OUT (L/R)** jacks of the DVD Player to the corresponding **AUDIO IN** jacks on the stereo system (cable supplied).

### Optional: Connecting Digital AV Receiver

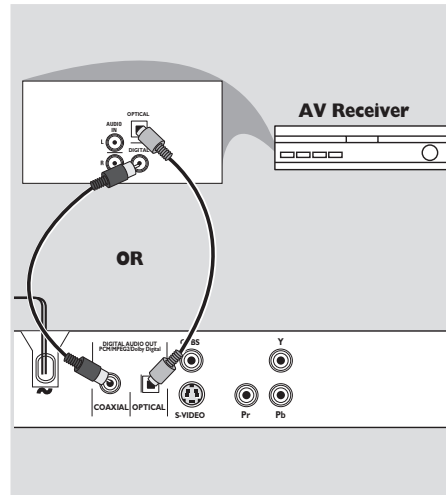

#### Receiver has a PCM, Dolby Digital, or MPEG2 decoder

- 1 Select one of the video connections (CVBS VIDEO IN, S-VIDEO IN, SCART, COMPONENT VIDEO IN) depending on the options available on your TV.
- 2 Connect the **COAXIAL** or **OPTICAL** jack of the DVD Player to the corresponding Digital Audio In jack on your Receiver (cable not supplied).
- 3 Set the DVD Player's Analog Output to 'Stereo' which delivers sound from only the two front speakers and subwoofer. (see page 25 "Setting the analogue output").

#### Helpful Hints:

- Some DVDs are copy protected. You cannot record the disc through a VCR or digital recording device.
- If the audio format of the Digital Output does not match the capabilities of your receiver, the receiver will produce a strong, distorted sound or no sound at all.

## Functional Overview

### Front and Rear Panels

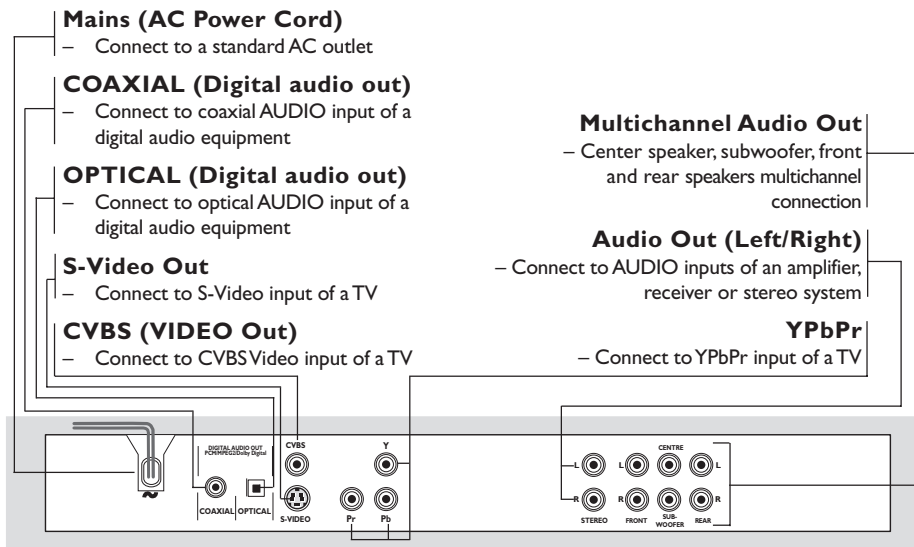
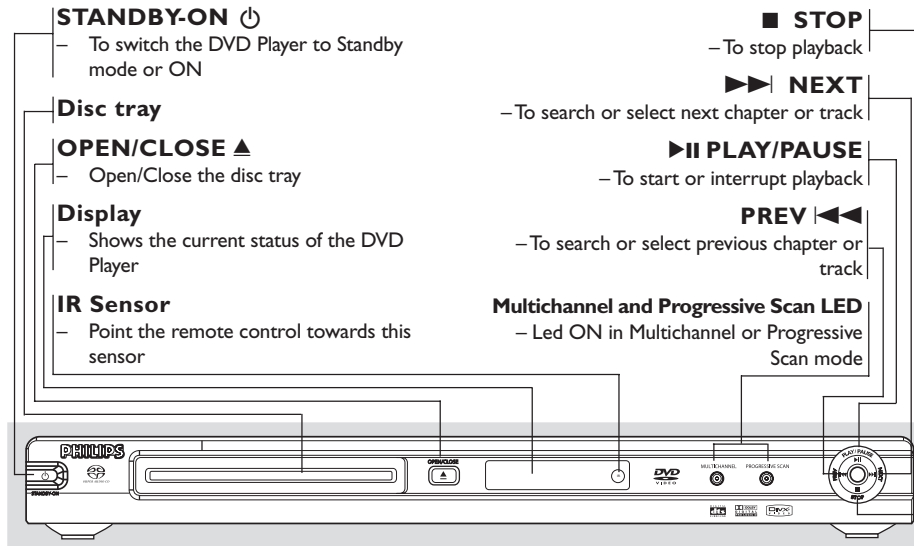

**Caution: Do not touch the inner pins of the jacks on the rear panel. Electrostatic discharge may cause permanent damage to the unit.**

# Functional Overview

English

## Remote Control

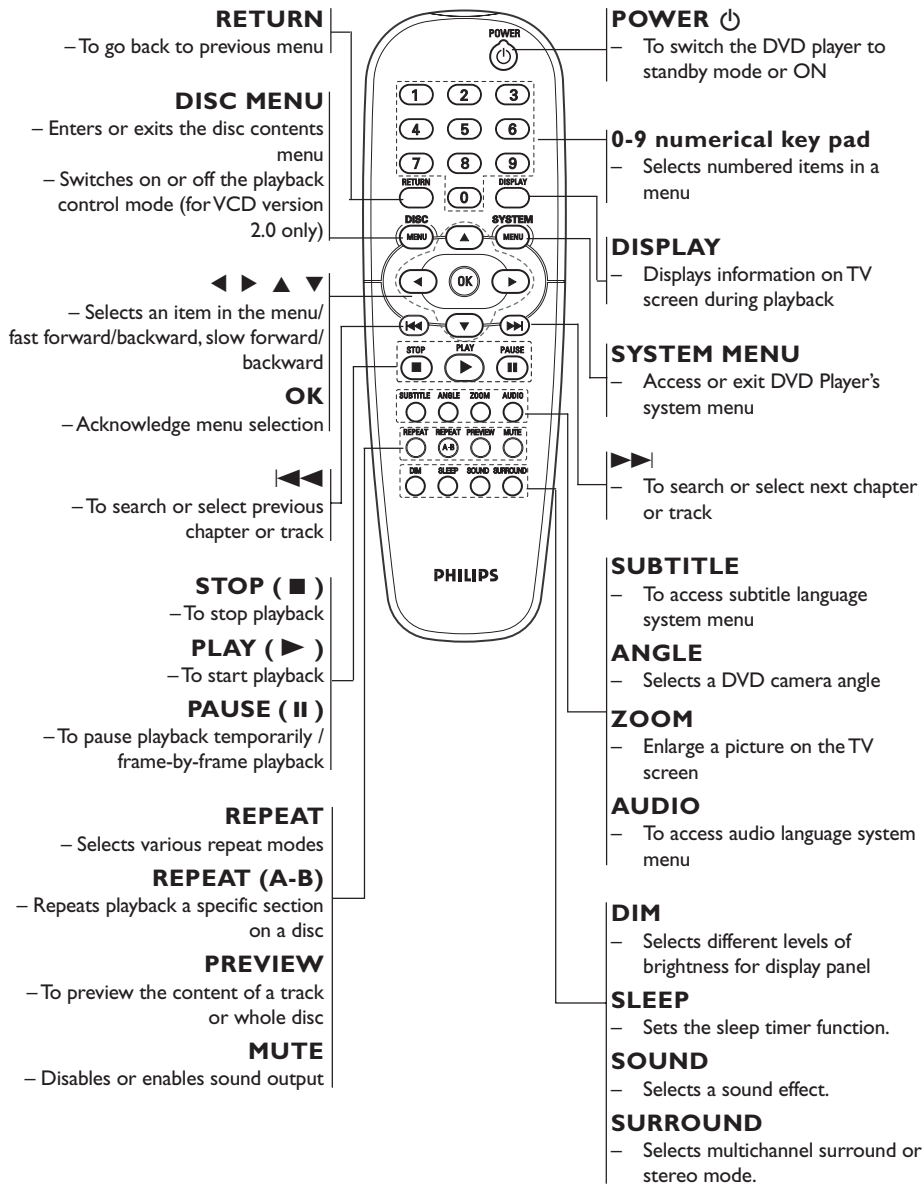

**Helpful Hint:**  
Press “STOP” for about 2 seconds to OPEN or CLOSE disc tray.

## Getting Started

### Step 1: Inserting batteries into the Remote Control

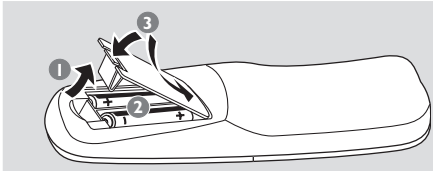

- 1 Open the battery compartment.
- 2 Insert two batteries type R06 or AA, following the indications (+ -) inside the compartment.
- 3 Close the cover.

### Using the Remote Control to operate the Player

- 1 Aim the Remote Control directly at the remote sensor (iR) on the front panel.
- 2 Do not put any objects between the Remote Control and the DVD Player while operating the DVD Player.

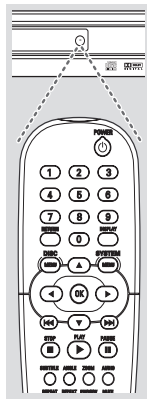

#### CAUTION!

- Remove batteries if they are exhausted or if the Remote Control is not being used for a long time.
- Do not use old and new or different types of batteries in combination.
- Batteries contain chemical substances, so they should be disposed properly.

### Step 2: Setting up the TV

#### IMPORTANT!

Make sure you have completed all the necessary connections. (See pages 6-7 "Connecting TV").

- 1 Turn on the TV and set to the correct video-in channel. You should see the Philips DVD background screen on the TV.
  - Usually these channels are between the lowest and highest channels and may be called FRONT, A/V IN, or VIDEO. See your TV manual for more details.
  - Or, you may go to channel 1 on your TV, then press the Channel down button repeatedly until you see the Video In channel.
  - Or, the TV Remote Control may have a button or switch that chooses different video modes.
  - Or, set the TV to channel 3 or 4 if you are using an RF modulator.
- 2 If you are using external equipment, (eg. audio system or receiver), turn it on and select the appropriate input source for the DVD Player output. Refer to the equipment owner's manual for detail.

#### To deactivate Progressive manually

The progressive scan display present 60 complete frames per seconds, rather than 30 frames per second of interlaced scanning (ordinary normal TV system). With nearly double the number of line, progressive scan offers higher picture resolution and eliminates bothersome motion artifacts those jagged edge on moving objects.

To enjoy the full quality potential offered by progressive scan feature, a progressive scan TV is required. To activate progressive function, refer to 'Progressive - turning on/off' on page 27.

## Getting Started

English

### To deactivate Progressive manually - cont'd

If the progressive function is activated, but your TV does not support progressive function or YPbPr cable is not connected accordingly, there will be a blank screen. You can deactivate progressive function as below:

- 1 Press **STANDBY ON** on the front panel to switch on the DVD player.
- 2 Press **OPEN/CLOSE** on the front panel to open the disc tray.
- 3 Press **◀** then, press **MUTE** on the remote control.  
→ You should see the Philips DVD background screen on the TV.

### Selecting the colour system that corresponds to your TV

This DVD Player is compatible with both NTSC and PAL. In order for a DVD disc to play on this Player, the colour system of the Disc, the TV and the DVD Player should match.

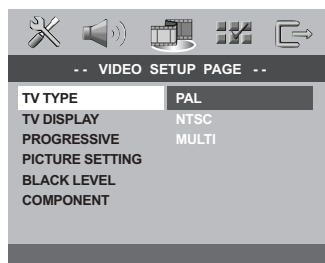

- 1 Press **SYSTEM MENU**.
- 2 Press **▶** repeatedly to select {VIDEO SETUP PAGE}.
- 3 Press **▲▼** to highlight {TV TYPE}, then press **▶**.

- 4 Press **▲▼** to highlight one of the options below:

**PAL** – Select this if the connected TV is PAL system. It will change the video signal of a NTSC disc and output in PAL format.

**NTSC** – Select this if the connected TV is NTSC system. It will change the video signal of a PAL disc and output in NTSC format.

**Multi** – Select this if the connected TV is compatible with both NTSC and PAL (multi-system). The output format will be in accordance with the video signal of the disc.

- 5 Select an item and press **OK**.

#### Helpful Hints:

- Before changing the current TV Standard setting, ensure that your TV supports the 'selected TV Type' system.
- If there is no proper picture on your TV, wait for 15 seconds for auto recovery.

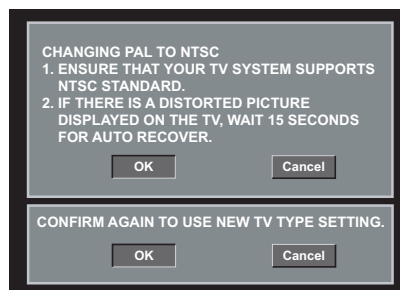

**TIPS:** To return to the previous menu, press **◀**.  
To remove the menu, press **SYSTEM MENU**.

## Getting Started

### Step 3: Setting language preference

You can select your own preferred language settings. This DVD Player will automatically switch to the language for you whenever you load a disc.

#### Setting the OSD Language

The On-screen language for the system menu will remain as you set it, regardless of various disc languages.

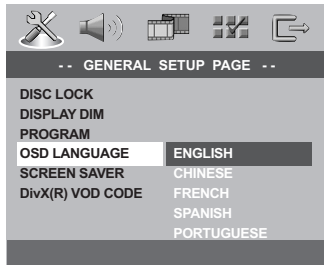

- 1 Press **SYSTEM MENU**.
- 2 Press **▶** to select {GENERAL SETUP PAGE}.
- 3 Press **▲▼** to highlight {OSD LANGUAGE}, then press **▶**.
- 4 Press **▲▼** to select a language and press **OK**.

### Setting the Audio, Subtitle and Disc menu language

You can choose your own preferred language or soundtrack from audio, subtitles and disc menu languages. If the language selected is not available on the disc, the disc's default language will be used instead.

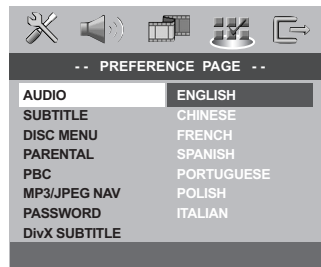

- 1 Press **STOP** twice then, press **SYSTEM MENU**.
- 2 Press **▶** repeatedly to select {PREFERENCE PAGE}.
- 3 Press **▲▼** to highlight one of the options below at a time, then press **▶**.
  - 'Audio' (disc's soundtrack)
  - 'Subtitle' (disc's subtitles)
  - 'Disc Menu' (disc's menu)
- 4 Press **▲▼** to select a language and press **OK**.

**If the language you want is not in the list, then select {OTHERS},** then use the **numeric keypad (0-9)** on the remote to enter the 4-digit language code 'XXXX' (see page 125 {Language Code}) and press **OK**.

- 5 Repeat steps 4~5 for other language settings.

**TIPS:** To return to the previous menu, press **◀**.  
To remove the menu, press **SYSTEM MENU**.

## Getting Started

### Step 4: Setting the speakers' channels

You can adjust the delay times (centre and surround only) and volume level for individual speakers. These adjustments let you optimise the sound according to your surroundings and setup.

#### IMPORTANT!

*The speaker settings only available on Multi-channel audio outputs. You can also press **SURROUND** button on the remote to select Multi-channel.*

- 1 Press **STOP** then, press **SYSTEM MENU**.
- 2 Press **▶** repeatedly to select {AUDIO SETUP PAGE}.
- 3 Press **▲▼** to highlight {SPEAKER SETUP}, then press **▶**.

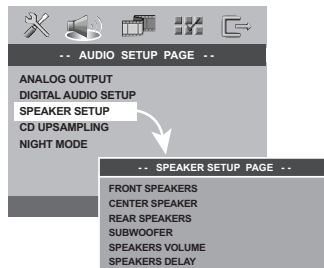

- 4 Enter its submenu by pressing **▶**.
- 5 Press **▲▼** to highlight one of the options below at a time, then press **▶**.

{FRONT SPEAKERS, CENTER SPEAKER, REAR SPEAKERS}

OFF – when no speaker is connected.  
 LARGE – when connected speakers can produce low frequency signals below 120Hz.

SMALL – when connected speakers cannot produce low frequency signals below 120Hz.

{SUBWOOFER}

ON – when a subwoofer is connected.  
 OFF – when no subwoofer is connected.

{SPEAKER VOLUME} – Volume level setting for individual speakers (-6dB ~ +6dB).

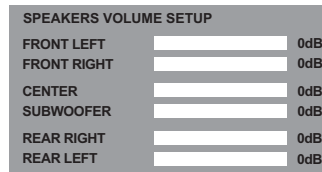

{SPEAKER DELAY} – Delay times setting in relation to the listening position/ distance for centre and surround speakers (1m ~ 10m).

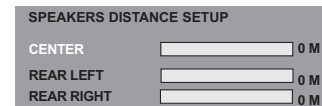

- 6 Press **◀▶** to adjust the setting that best suit your surround sound needs.
- 7 Press **OK** to confirm.

#### Helpful Hints:

- Use the longer delay time settings when the rear speakers are closer to the listener than the front speakers.
- The test tone will be automatically generated to help you judge the sound level of each speaker.

**TIPS:** To return to the previous menu, press **◀**.  
 To remove the menu, press **SYSTEM MENU**.

## Disc Operations

### IMPORTANT!

- If the inhibit icon (Ø or X) appears on the TV screen when a button is pressed, it means the function is not available on the current disc or at the current time.
- Depending on the DVD or VIDEO CD, some operations may be different or restricted.
- Do not push on the disc tray or put any objects other than disc on the disc tray. Doing so may cause the disc player malfunction.

### Playable Discs

#### Your DVD Player will play:

- Digital Versatile Discs (DVDs)
- Video CDs (VCDs)
- Super Video CDs (SVCDs)
- Super Audio CDs (SACDs)
- Digital Versatile Discs + Recordable [Rewritable] (DVD+R[W])
- Compact Discs (CDs)
- MP3 discs, picture (Kodak, JPEG) files on CD-R(W).
  - JPEG/ISO 9660 format
  - Maximum 30 characters display.
  - Supported sampling frequencies : 32 kHz, 44.1 kHz, 48 kHz (MPEG-1) 16 kHz, 22.05 kHz, 24 kHz (MPEG-2)
  - Supported Bit-rates : 32~256 kbps (MPEG-1), 8~160 kbps (MPEG-2) variable bitrates
- MPEG-4 disc on CD-R(W):
  - Simple profile
  - Advanced simple profile (640-480)
- DivX disc on CD-R[W]/DVD+R[W]:
  - DivX 3.11, 4.x and 5.x
  - GMC (Global Motion Compensation) and QP (Quarter Pixel) not supported.



**TIPS:** The operating features described here might not be possible for certain discs. Always refer to the instructions supplied with the discs.

### Region Codes

DVD discs must be labeled for ALL regions or Region 3 in order to play on this Player. You cannot play Discs that are labeled for other regions.



#### Helpful Hints:

- It may not be possible to play CD-R/RW or DVD-R/RW in all cases due to the type of disc or condition of the recording.
- If you are having trouble playing a certain disc, remove the disc and try a different one. Improper formatted disc will not play on this DVD Player.

### Playing discs

- 1 Connect the power cords of the DVD Player and TV (and any optional stereo or AV receiver) to a power outlet.
- 2 Turn on the TV power and set to the correct Video In channel. (See page 12 "Setting up the TV").
- 3 Press **STANDBY-ON** on the DVD Player front panel.
  - You should see the Philips DVD background screen on the TV.
- 4 Press **OPEN•CLOSE** ▲ button to open the disc tray and load in a disc, then press the same button again to close the disc tray.
  - Make sure the label side is facing up. For double-sided discs, load the side you want to play facing up.
- 5 Playback will start automatically. If not press **PLAY** ►.
  - If a disc menu appears on the TV, see page 18 "Using the Disc Menu".
  - If the disc is locked by parental control, you must enter your six-digit password. (See page 30).



## Disc Operations

### Basic playback controls

Unless otherwise stated, all operations described are based on Remote Control use.

#### Pausing playback

- 1 During playback, press **II**.  
→ Playback will pause and sound will be muted.
- 2 Press **II** again to select the next picture frame.
- 3 To resume normal playback, press **PLAY ►**.

#### Selecting track/chapter

- Press **◀◀ / ▶▶** or use the numeric keypad (0-9) to key in a track/chapter number.  
→ If repeat mode is active, pressing **◀◀ / ▶▶** will replay the same track/chapter.

#### Searching backward/forward

- Press and hold **◀◀ / ▶▶**, then press **PLAY ►** to resume normal playback.  
→ While searching, pressing **◀◀ / ▶▶** again will decrease/increase the search speed.

#### Stopping playback

- Press **■**.

### Selecting various repeat/shuffle functions

#### Repeat play mode

- While playing a disc, press **REPEAT** continuously to choose a 'Play Mode'.

#### DVD

- RPT ONE (repeat chapter)
- RPT TT (repeat title)
- SHUFFLE (random play)
- RPT SHF (repeat shuffle)
- RPT OFF (repeat off)

#### VCD/SVCD/CD

- RPT ONE (repeat track)
- RPT ALL (repeat disc)
- SHUFFLE (random play)
- RPT SHF (repeat shuffling)
- RPT OFF (repeat off)

#### MP3/SACD/DivX

- RPT FLD (repeat folder)
- RPT ONE (repeat track)
- SHUFFLE (random play)
- RPT OFF (repeat off)

#### Helpful Hint:

- For VCD, repeat playback is not possible if the PBC mode is switched on.

#### Repeating a section within a chapter/track

- 1 While playing a disc, press **REPEAT A-B** at your chosen starting point.
- 2 Press **REPEAT A-B** again at your chosen end point.  
→ The section A and B can be set only within the same chapter/track.  
→ The section will now repeat continuously.
- 3 To exit the sequence, press **REPEAT A-B**.

**TIPS:** The operating features described here might not be possible for certain discs. Always refer to the instructions supplied with the discs.

## Disc Operations

### Operations for video playback (DVD/VCD/SVCD)

#### Using the Disc Menu

Depending on the disc, a menu may appear on the TV screen once you load in the disc.

#### To select a playback feature or item

- Use ◀▶▲▼ keys or **numeric keypad (0-9)** on the remote, then press **OK** to start playback.

#### To access or remove the menu

- Press **DISC MENU** on the remote.

#### Zooming in

This function allows you to enlarge the picture on the TV screen and to pan through the enlarged picture.

- 1 During playback, press **ZOOM** repeatedly to display the picture with different scales.
  - Use ◀▶▲▼ keys to pan through the enlarged picture.
  - Playback will continue.
- 2 Press **ZOOM** repeatedly to return to the original size.

#### Resuming playback from the last stopped point

Resume playback of the last 10 discs is possible, even if the disc was ejected or the power switched off.

- Load one of the last 10 discs.
  - "LOADING" appears.
- Press **PLAY ▶** and the disc will be played back from the last point.

#### To cancel resume mode

- In stop mode, press **STOP ■** again.

**TIPS:** The operating features described here might not be possible for certain discs. Always refer to the instructions supplied with the discs.

### Using the OSD menu

OSD menu shows the disc playback information (for example, title or chapter number; elapsed playing time, audio/subtitle language), a number of operations can be done without interrupting disc playback.

- 1 During playback, press **DISPLAY**.
  - A list of available disc information appears on the TV screen.

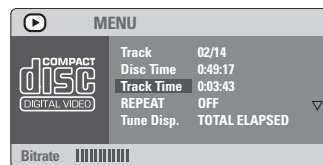
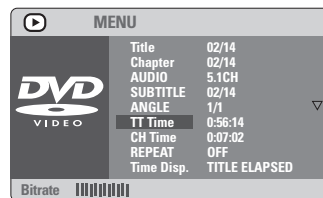

- 2 Press ▲▼ to view the information and press **OK** to access.
- 3 Use the **numeric keypad (0-9)** to input the number/time or press ▲▼ to make the selection, then press **OK** to confirm.
  - Playback will change to the chosen time or to the selected title/chapter/track.

## Disc Operations

English

### Special DVD Features

#### Playing a Title

- 1 Press **DISC MENU**.  
→ The disc title menu appears on the TV screen.
- 2 Use **▲▼◀▶** keys or **numeric keypad (0-9)** to select a play option.
- 3 Press **OK** key to confirm.

#### Camera Angle

- Press **ANGLE** repeatedly to select different desired angle.

#### Changing the Audio Language

##### For DVD

- Press **AUDIO** repeatedly to select different audio languages.

##### Changing the Audio Channel

##### For VCD

- Press **AUDIO** to select the available audio channels provided by the disc (LEFT VOCAL, RIGHT VOCAL, MONO LEFT, MONO RIGHT, STEREO).

#### Subtitles

- Press **SUBTITLE** repeatedly to select different subtitle languages.

### Special VCD & SVCD Features

#### Playback Control (PBC)

##### For VCD with Playback Control (PBC) feature (version 2.0 only)

- Press **DISC MENU** to toggle between 'PBC ON' and 'PBC OFF'.  
→ If you select 'PBC ON', the disc menu (if available) will appear on the TV.  
→ Use the **◀◀ / ▶▶** or the numeric keypad (0-9) to select a play option.
- During playback, pressing **RETURN** will return to the menu screen (if PBC is on).

##### If you want to skip the index menu and playback directly from the beginning,

- Press **DISC MENU** key on the remote control to switch to PBC off.

**TIPS:** The operating features described here might not be possible for certain discs. Always refer to the instructions supplied with the discs.

## Disc Operations

### Preview Function

- 1 Press **PREVIEW**.
- 2 Press **▲▼** to highlight {TRACK DIGEST}, {DISC INTERVAL} or {TRACK INTERVAL}.
- 3 Press **OK** to open one option.

SELECT DIGEST TYPE:  
TRACK DIGEST  
DISC INTERVAL  
TRACK INTERVAL

#### Track Digest

This function will minimise the picture of every track in order to display every six of these tracks on the screen to help you know the content of every track on the disc.

#### Disc Interval

This function is used to divide a disc into six parts by regular intervals and display them on one page to preview the whole disc.

#### Track Interval

This function is used to divide a single track into six parts by regular intervals and display them on one page to help you preview the selected track.

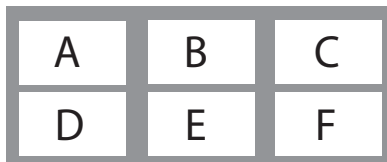

(example for 6 thumbnail pictures display)

- 4 Use **◀▶▲▼** keys to select a track or use **numeric keypad (0-9)** to input the selected track number next to {SELECT}.
- 5 Press **◀◀ / ▶▶** to open the previous or next page.
- 6 Press **OK** to confirm.

**TIPS:** The operating features described here might not be possible for certain discs. Always refer to the instructions supplied with the discs.

### To quit preview function

- Use **◀▶▲▼** keys to highlight {EXIT} and press **OK** to confirm.

### To return to preview menu

- Use **◀▶▲▼** keys to highlight {MENU} and press **OK** to confirm.

### For CD

- At stop mode, press **PREVIEW** on the remote control.
  - Each track will be played for a few seconds.
  - For JPEG CD, press **PREVIEW** to view 12 thumbnail pictures on the TV screen (see page 22).

### Playing MP3/DivX/MPEG-4/ JPEG/Kodak Picture CD

#### IMPORTANT!

You have to turn on your TV and set to the correct Video In channel. (See page 12 "Setting up the TV").

### General Operation

- 1 Load a disc.
  - The disc reading time may exceed 30 seconds due to the complexity of the directory/file configuration.
  - The data disc menu appears on the TV screen.
- 2 Playback will start automatically. If not press **PLAY ▶**.

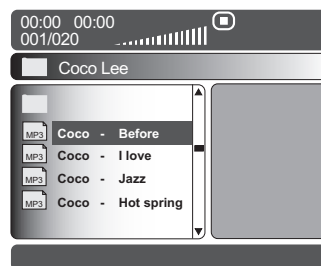

## Disc Operations

### Selecting a folder and track/file

- 1 Press ▲▼ to select the folder and press **OK** to open the folder.
- 2 Press ▲▼ to select a track/file.
- 3 Press **OK** to confirm.  
→ Playback will start from the selected file to the end of the folder.

During playback, you can;

- Press |◀◀/▶▶| to select another track/file in the current folder.
- To select another folder from the current disc, press ◀ to return to the root menu, then press ▲▼ to make your selection and press **OK** to confirm.
- Press **REPEAT** continuously to access different 'Play Mode'.  
→ **FOLDER**: files will be played back once.  
→ **REPEAT ONE**: one file being played repeatedly.  
→ **REPEAT FOLDER**: all files in one folder being played repeatedly.  
→ **SHUFFLE**: all files in the current folder being played at random order.
- Press **||** to pause playback.

#### Helpful Hints:

- It may not be possible to play certain MP3/JPEG/DivX/MPEG-4 disc due to the configuration and characteristics of the disc or condition of the recording.
- It is normal to experience an occasional "skip" while listening to your MP3 disc.
- It is normal to experience an occasional pixelation during MPEG-4/DivX playback due to poor clarity of digital contents during internet downloading.
- For multi-session discs with different formats, only the first session will be available.

### Playing Super Audio CD (SACD)

There are three types of SACD discs: single layer, double layer or hybrid disc. The hybrid disc contains both Super Audio CD and standard audio CD layers, only the SACD layer is possible to playback on this DVD player.

- 1 Load a SACD.  
→ The disc menu appears on the TV screen.
- 2 Playback will start automatically.  
→ If the SACD consists of multi-channel and stereo tracks, multi-channel tracks will have the priority for playback.  
→ To playback stereo tracks, use ▲▼ keys to make your selection from the disc menu, then press **PLAY ▶**.

#### Helpful Hints:

- **SURROUND** button is not functional for SACD playback. You have to access to the disc menu in order to select between multi-channel and stereo tracks.
- Programme SACD tracks is not possible.

**TIPS:** The operating features described here might not be possible for certain discs. Always refer to the instructions supplied with the discs.

## Disc Operations

### Special picture disc features

#### IMPORTANT!

You have to turn on your TV and set to the correct Video In channel. (See page 12 "Setting the TV").

- Load a Picture disc (Kodak Picture CD, JPEG).
  - For Kodak disc, the slide show will begin.
  - For JPEG disc, the picture menu appears on the TV screen. Press ► to start the slide-show playback.

### Preview Function (JPEG)

This function shows the content of the current folder or the whole disc.

- 1 Press **STOP** during playback.
  - 12 thumbnail pictures will appear on the TV screen.



- 2 Press |◀◀ / ▶▶| to display the other pictures on the previous/next page.
- 3 Use ◀▶ ▲▼ to highlight one of the picture and press **OK** to start playback
- 4 Press **DISC MENU** to return to Picture CD menu.

### Zoom picture

- 1 During playback, press **ZOOM** repeatedly to display the picture with different scales.
- 2 Use ◀▶ ▲▼ keys to view the zoomed picture.

### Playback with multi-angles

- During playback, press ▲▼◀▶ to rotate the picture on the TV screen.
  - ▲: flip the picture vertically
  - ▼: flip the picture horizontally
  - ◀: rotate the picture anti-clockwise
  - ▶: rotate the picture clockwise

### Scan Effect

- Press **ANGLE** repeatedly to choose different scan effect.
  - Various scan effect appears on the top left hand corner on the TV screen.

### Playing MP3 music and JPEG picture simultaneously

- 1 Load a disc that contains music and picture.
  - The disc menu appears on the TV screen.
- 2 Select an MP3 track.
- 3 During MP3 music playback, select a picture from the TV screen and press **PLAY ▶**.
  - The picture files will be played back one after another until end of the folder.
- 4 To quit simultaneous playback, press **DISC MENU** followed by ■.

#### Helpful Hint:

- Some files on Kodak or JPEG disc may be distorted during playback due to the configuration and characteristics of the disc.

**TIPS:** The operating features described here might not be possible for certain discs. Always refer to the instructions supplied with the discs.

## DVD Setup Menu Options

This DVD Player setup is carried out via the TV, enabling you to customise the DVD Player to suit your particular requirements.

### General Setup menu

- 1 In disc mode, press **SYSTEM MENU**.
- 2 Press **◀▶** to select 'General Setup' icon.
- 3 Press **OK** to confirm.

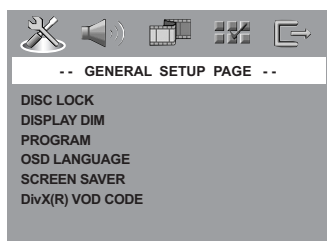

### Locking/Unlocking the disc for viewing

Not all discs are rated or coded by the disc maker. You can prevent a specific disc from playing by locking the disc. Up to 40 discs can be locked.

- 1 In 'GENERAL SETUP PAGE', press **▲▼** to highlight {DISC LOCK}, then press **▶**.

#### LOCK

Select this to block the playback of the current disc. Subsequent access to a locked disc requires six-digit password. The default password is '136 900' (see page 30 "Changing the password").

#### UNLOCK

Select this to unlock the disc and allow future playback.

- 2 Press **▲▼** to select a setting, then press **OK** to confirm your selection.

### Dimming player's display panel

You can select different levels of brightness for the display screen.

- 1 In 'GENERAL SETUP PAGE', press **▲▼** to highlight {DISPLAY DIM}, then press **▶**.  
**100%** – Select this for full brightness.  
**70%** – Select this for medium brightness.  
**40%** – Select this for dimming the display.
- 2 Press **▲▼** to select a setting, then press **OK** to confirm your selection.

### Programming disc tracks (not for Picture CD/MP3/SACD)

You can play the contents of the disc in the order you want by programming the tracks to be played. Up to 20 tracks can be stored.

- 1 In 'GENERAL SETUP PAGE', press **▲▼** to highlight {PROGRAM}, then press **▶** to select {INPUT MENU}.
- 2 Press **OK** to confirm.

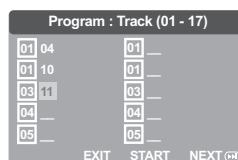

### To input your favourite tracks/chapter

- 3 Use the **numeric keypad (0-9)** to enter a valid track/chapter number.
- 4 Use **◀▶ ▲▼** keys to move the cursor to the next position.  
 → If the track number is more than ten, press **▶▶▶** to open the next page and proceed with programming or,  
 → Use **◀▶ ▲▼** keys to highlight {NEXT} on the programme menu, then press **OK**.
- 5 Repeat steps 3~4 to input another track/chapter number.

**TIPS:** To return to the previous menu, press **◀**.  
 To remove the menu, press **SYSTEM MENU**.

## DVD Setup Menu Options

### If you want to remove a track

- 6 Use ◀▶ ▲▼ keys to move the cursor to the track you want to remove.
- 7 Press **OK** to remove this track from the programme menu.

### To start programme playback

- 8 Use ◀▶ ▲▼ keys to highlight {START} on the programme menu, then press **OK**.  
→ Playback will start with the selected tracks under the programmed sequence.

### To exit programme playback

- 9 Use ◀▶ ▲▼ keys to highlight {EXIT} on the programme menu, then press **OK**.

### OSD Language

This menu contains various language options for display language on the screen. For details, see page 14.

### Screen Saver - turning on/off

The screen saver will help to prevent your TV display device from becoming damaged.

- 1 In 'GENERAL SETUP PAGE', press ▲▼ to highlight {SCREEN SAVER}, then press ▶.

#### **ON**

Select this if you wish to turn off the TV screen when disc playback is stopped or paused for more than 15 minutes.

#### **OFF**

Select this to disable the screen saver function.

- 2 Press ▲▼ to select a setting, then press **OK** to confirm your selection.

### DivX(R) VOD registration code

Philips provide you the DivX® VOD (Video On Demand) registration code that allows you to rent and purchase videos using the DivX® VOD service. For more information, visit us at [www.divx.com/vod](http://www.divx.com/vod).

- 1 In 'GENERAL SETUP PAGE', press ▲▼ to highlight {DIVX(R) VOD CODE}, then press ▶.  
→ The registration code will appear.
- 2 Press **OK** to exit.
- 3 Use the registration code to purchase or rent the videos from DivX® VOD service at [www.divx.com/vod](http://www.divx.com/vod). Follow the instructions and download the video onto a CD-R for playback on this DVD player.

#### Helpful Hints:

- All the downloaded videos from DivX® VOD can only be played back on this DVD player.
- Time search feature is not available during DivX movie playback.

### Audio Setup Menu

- 1 In disc mode, press **SYSTEM MENU**.
- 2 Press ◀▶ to select 'Audio Setup' icon.
- 3 Press **OK** to confirm.

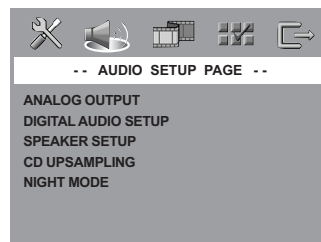

**TIPS:** To return to the previous menu, press ◀.  
To remove the menu, press **SYSTEM MENU**.



## DVD Setup Menu Options

### Digital Audio Setup

The options included in Digital Audio Setup are: 'Digital Output' and 'LPCM Output'.

- 1 In 'AUDIO SETUP PAGE', press ▲▼ to highlight {DIGITAL AUDIO SETUP}, then press ►.
- 2 Press the ▲▼ keys to highlight an option.
- 3 Enter its submenu by pressing ►.
- 4 Move the cursor by pressing the ▲▼ keys to highlight the selected item.

#### Digital Output

Set the Digital output according to your optional audio equipment connection.

→ **Off**: Turn off the digital output.

→ **All**: If you have connected your DIGITAL AUDIO OUT to a multi-channel decoder/receiver.

→ **PCM Only**: Only if your receiver is not capable of decoding multi-channel audio.

*Helpful Hint:*

- If DIGITAL OUTPUT is set to 'All', all audio settings except MUTE are invalid.
- You cannot hear or record the SACD playback if you use the digital connection.

#### LPCM Output

If you connect the DVD Player to a PCM compatible receiver via the digital terminals, such as coaxial or optical etc, you may need to adjust 'LPCM Output'. Discs are recorded at a certain sampling rate. The higher the sampling rate, the better the sound quality.

→ **48kHz**: Playback a disc recorded at the sampling rate of 48kHz.

→ **96kHz**: Playback a disc recorded at the sampling rate of 96kHz that can only be achieved in Stereo-Classic mode.

*Helpful Hint:*

- LPCM Output can be selected only when PCM Only is activated.

### Setting the analogue output

Set Analogue Output to match your DVD Player's playback capability. This function can also be accessed via the **SURROUND** button on the remote.

- 1 In 'AUDIO SETUP PAGE', press ▲▼ to highlight {ANALOG OUTPUT}, then press ►.

#### STEREO

Select this to change channel output to stereo which delivers sound from only the two front speakers and subwoofer.

#### MULTI-CHANNEL

Select this to enable Multi-channel output.

- 2 Press ▲▼ to select a setting, then press **OK** to confirm your selection.

### Speaker Setup

This menu contains setup options for your audio output which makes the speaker setup system reproduce high quality surround sound. For details, see page 15.

### CD Upsampling

This feature allows you to convert your music CD to a higher sampling rate using sophisticated digital signal processing for better sound quality.

- 1 In 'AUDIO SETUP PAGE', press ▲▼ to highlight {CD UPSAMPLING}, then press ►.

#### OFF

Select this to disable CD-upsampling.

#### 88.2 kHz (X2)

Select this to convert the sampling rate of the CDs twice higher than the original.

#### 176.4 kHz (X4)

Select this to convert the sampling rate of the CDs four times higher than the original.

- 2 Press ▲▼ to select a setting, then press **OK** to confirm your selection.

*Helpful Hint:*

- CD upsampling feature is only applicable to stereo output setting.

**TIPS:** To return to the previous menu, press ◀.  
To remove the menu, press **SYSTEM MENU**.

## DVD Setup Menu Options

### Night Mode - turning on/off

In this mode, the high volume outputs are softened and low volume outputs are brought upward to an audible level. It is useful for watching your favourite action movie without disturbing others at night.

- In 'AUDIO SETUP PAGE', press ▲▼ to highlight {NIGHT MODE}, then press ►.

#### ON

Select this to level out the volume. This feature is only available for movies with Dolby Digital mode.

#### OFF

Select this when you want to enjoy the surround sound with its full dynamic range.

- Press ▲▼ to select a setting, then press **OK** to confirm your selection.

### Video Setup Menu

- In disc mode, press **SYSTEM MENU**.
- Press ◀▶ to select 'Video Setup' icon.
- Press **OK** to confirm.

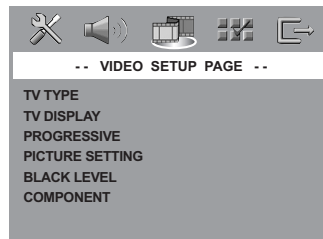

### TV Type

This menu contains the options for selecting the colour system that matches the connected TV. For details, see page 13.

### Setting the TV Display

Set the aspect ratio of the DVD Player according to the TV you have connected. The format you select must be available on the disc. If it is not, the setting for TV display will not affect the picture during playback.

- In 'VIDEO SETUP PAGE', press ▲▼ to highlight {TV DISPLAY}, then press ►.
- Press ▲▼ to highlight one of the options below:

#### 4:3 PAN SCAN –

Select this if you have a normal TV and want both sides of the picture to be trimmed or formatted to fit your TV screen.



#### 4:3 LETTER BOX –

Select this if you have a normal TV. In this case, a wide picture with black bands on the upper and lower portions of the TV screen will be displayed.



**16:9** – Select this if you have a wide-screen TV.



- Select an item and press **OK**.

**TIPS:** To return to the previous menu, press ◀.  
To remove the menu, press **SYSTEM MENU**.

## DVD Setup Menu Options

### Progressive - turning on/off

This feature is only applicable if you have connected this DVD Player to a Progressive Scan TV through the Y Pb Pr jacks (see page 7).

- In 'VIDEO SETUP PAGE', press ▲▼ to highlight {PROGRESSIVE}, then press ►.

#### **OFF**

To disable Progressive Scan function.

#### **ON**

To enable Progressive Scan function.

- Press ▲▼ to select a setting, then press **OK** to confirm your selection.

#### *Helpful Hint:*

- To deactivate the progressive function manually, see page 12.

### Picture Setting

This DVD Player provides three predefined sets of picture colour settings and one personal setting which you can define yourself.

- In 'VIDEO SETUP PAGE', press ▲▼ to highlight {PICTURE SETTING}, then press ►.

#### **STANDARD**

Select this for standard picture setting.

#### **BRIGHT**

Select this will make the TV picture brighter.

#### **SOFT**

Select this will make the TV picture softer.

#### **PERSONAL**

Select this to personalise your picture colour by adjusting the brightness, contrast, tint and colour (saturation).

- Press ▲▼ to select a setting, then press **OK** to confirm your selection.
- If you select {PERSONAL}, then proceed to steps 4~7.  
→ The 'PERSONAL PICTURE SETUP' menu appears.

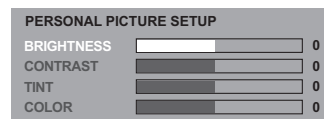

**TIPS:** To return to the previous menu, press ◀.  
To remove the menu, press **SYSTEM MENU**.

## DVD Setup Menu Options

- 4 Press ▲▼ to highlight one of the following options.

### **BRIGHTNESS**

Increase the value will brighten the picture or vice versa. Choose zero (0) for average setting.

### **CONTRAST**

Increase the value will sharpen the picture or vice versa. Choose zero (0) to balance the contrast.

### **TINT**

Increase the value will darken the picture or vice versa. Choose zero (0) for average setting.

### **COLOUR**

Increase the value will enhance the colour in your picture or vice versa. Choose zero (0) to balance the colour.

- 5 Press ◀▶ to adjust the setting that best suit your personal preference.
- 6 Repeat steps 4~5 for adjusting other colour features.
- 7 Press **OK** to confirm.

### Preference Page

- 1 Press ■ twice to stop playback (if any), then press **SYSTEM MENU**.
- 2 Press ◀▶ to select the 'Preference Setup' icon.
- 3 Press **OK** to confirm.

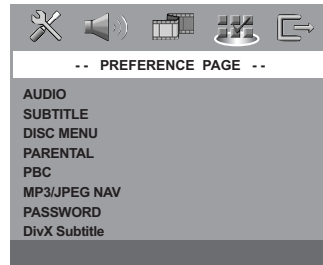

### Audio, Subtitle, Disc Menu

These menus contain various language options for audio, subtitle and disc menu which may be recorded on the DVD. For details, see page 14.

DivX Subtitle (LX390  
Standard - default font  
Cyrillic - subtitle fonts  
appears on cyrillic.

**TIPS:** To return to the previous menu, press ◀.  
To remove the menu, press **SYSTEM MENU**.

## DVD Setup Menu Options

### Restricting playback by Parental Control

Some DVDs may have a parental level assigned to the complete disc or to certain scenes on the disc. This feature lets you set a playback limitation level. The rating levels are from 1 to 8 and are country dependent. You can prohibit the playing of certain discs that are not suitable for your children or have certain discs played with alternative scenes.

- In 'PREFERENCE PAGE', press ▲▼ to highlight {PARENTAL}, then press ►.

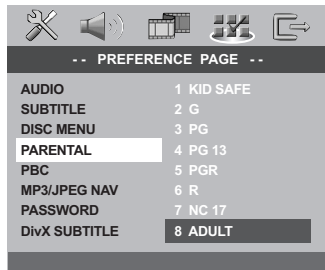

- Press ▲▼ to highlight a rating level for the disc inserted and press **OK**.  
→ To disable Parental controls and have all Discs play, select {8 ADULT}.
- Use the **numeric keypad (0-9)** to enter the six-digit password (see page 30 "Changing the password").  
→ DVDs that are rated above the level you selected will not play unless you enter your six-digit password.

#### Helpful Hints:

- VCD, SVCD, CD have no level indication, so parental control function has no effect on these type of discs. This applies to most illegal DVD discs.
- Some DVDs are not encoded with a rating though the movie rating may be printed on the Disc cover. The rating level feature does not work for such Discs.

### PBC

You can set the PBC to ON or OFF. This feature is available only on Video CD 2.0 with playback control (PBC) feature. For details, see page 19.

### MP3/JPEG Menu - turning on/off

MP3/JPEG Navigator can be set only if the disc is recorded with menu. It allows you to select different display menus for easy navigation.

- In 'PREFERENCE PAGE', press ▲▼ to highlight {MP3/JPEG NAV}, then press ►.

#### WITHOUT MENU

Select this to display all the files contained in the MP3/Picture CD.

#### WITH MENU

Select this to display only the folder menu of the MP3/Picture CD.

- Press ▲▼ to select a setting, then press **OK** to confirm your selection.

**TIPS:** To return to the previous menu, press ◀.  
To remove the menu, press **SYSTEM MENU**.

## DVD Setup Menu Options

### Changing the Password

The same password is used for both Parental Control and Disc Lock. Enter your six-digit password when prompted on the screen. The default password is 136 900.

- 1 In 'PREFERENCE PAGE', press ▲▼ to highlight {PASSWORD}, then press ► to select {CHANGE}.

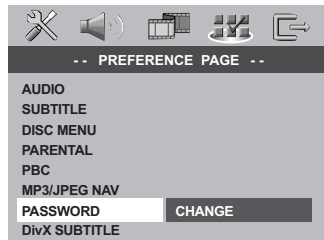

- 2 Press **OK** to enter the 'Password Change Page'.

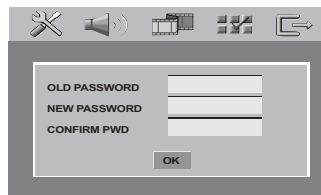

- 3 Use the **numeric keypad (0-9)** to enter your old six-digit password.  
→ When doing this for the first time, key in '136 900'.
- 4 Enter the new six-digit password.
- 5 Enter the new six-digit password a second time to confirm.  
→ The new six-digit password will now take effect.
- 6 Press **OK** to confirm.

### Setting the DivX Subtitle

- 1 **When selecting an embedded subtitle during playback,**  
Load a DivX disc and press **SUBTITLE** repeatedly to select available subtitle.
  - 2 **When selecting an external DivX text subtitle during playback,**  
If available on the recorded disc, you can select the external DivX subtitle in text format.
- 1 In 'PREFERENCE PAGE', press ▲▼ to highlight {DivX SUBTITLE}, then press ►.

#### STANDARD

A standard list of English subtitle fonts provided by this DVD Player.

#### CYRILLIC

Select this to display a cyrillic subtitle fonts.

- Press ▲▼ to select a setting, then press **OK** to confirm your selection.
- You can also press **SUBTITLE** repeatedly to select available subtitle.

#### Helpful Hints:

- Subtitle files with the following filename extensions (.srt, .smi, .sub, .ssa, .ass) are supported but do not appear on the file navigation menu.
- The subtitle filename have to be the same as the filename of the movie.

### Restoring to original settings

Setting the DEFAULT function will reset all options and your personal settings to the factory defaults, except your password for Parental Control and Disc Lock.

- 1 In 'PREFERENCE PAGE', press ▲▼ to highlight {DEFAULT}, then press ► to select {RESET}.
- 2 Press **OK** to confirm.  
→ All settings will now reset to factory defaults.

# Specifications

English

## TV STANDARD (PAL/50Hz) (NTSC/60Hz)

Number of lines	625	525
Playback	Multistandard	(PAL/NTSC)

## VIDEO PERFORMANCE

YPbPr	0.7Vpp — 75 ohm
Video Output	1Vpp — 75 ohm
S-Video Output	Y: 1Vpp — 75 ohm C: 0.3Vpp — 75 ohm
Video DAC	108MHz / 12bit

## VIDEO FORMAT

Digital Compression	MPEG 2 for DVD,SVCD MPEG 1 for VCD MPEG-4/DivX
---------------------	--

<b>DVD</b>	<b>50Hz</b>	<b>60Hz</b>
Horiz. resolution	720 pixels	720 pixels
Vertical resolution	576 lines	480 lines

<b>VCD</b>	<b>50Hz</b>	<b>60Hz</b>
Horiz. resolution	352 pixels	352 pixels
Vertical resolution	288 lines	240 lines

## AUDIO FORMAT

Digital	Mpeg/ AC-3/ PCM	compressed Digital 16, 20, 24 bits fs, 44.1, 48, 96 kHz
	MP3(ISO 9660)	96, 112, 128, 256 kbps & variable bit rate fs, 32, 44.1, 48 kHz

Full decoding of Dolby Digital and DTS multi-channel sound  
Analog Sound Stereo  
Dolby Surround compatible downmix from Dolby Digital multi-channel sound  
Dolby Pro Logic II  
3D sound for virtual 5.1 channel sound on 2 speakers

## AUDIO PERFORMANCE

DA Converter	24 bit, 192kHz
DVD	fs 96 kHz 4Hz- 44kHz fs 48 kHz 4Hz- 22kHz
SVCD	fs 48 kHz 4Hz- 22kHz fs 44.1kHz 4Hz- 20kHz
CD/VCD	fs 44.1kHz 4Hz- 20kHz
Signal-Noise (1kHz)	110 dB
Dynamic range(1kHz)	97 dB
Crosstalk (1kHz)	105 dB
Distortion/noise (1kHz)	90 dB
MPEG MP3	MPEG Audio L3

## CONNECTIONS

YPbPr Output	Cinch 3x
S-Video Output	Mini DIN, 4 pins
Video Output	Cinch (yellow)
Audio Output(L+R)	Cinch (white/red)
Digital Output	1 coaxial, 1 optical
	IEC60958 for CDDA / LPCM IEC61937 for MPEG 1/2, Dolby Digital

## CABINET

Dimensions (w x h x d)	435 x 50 x 310 mm
Weight	Approximately 1.9 kg

## POWER CONSUMPTION

Power Supply Rating	110 – 127 / 220 – 240V; 50/60 Hz
Power consumption	< 14W
Power consumption in Standby mode	< 1W

Specifications subject to change without prior notice

## Troubleshooting

### WARNING

Under no circumstances should you try to repair the system yourself, as this will invalidate the warranty. Do not open the system as there is a risk of electric shock.

If a fault occurs, first check the points listed below before taking the system for repair. If you are unable to remedy a problem by following these hints, consult your dealer or Philips for help.

Problem	Solution
<b>No power</b>	<ul style="list-style-type: none"> <li>– Check if the AC power cord is properly connected.</li> <li>– Press the STANDBY ON on the front of the DVD system to turn on the power.</li> </ul>
<b>No picture</b>	<ul style="list-style-type: none"> <li>– Refer to your TV's manual for correct Video In channel selection. Change the TV channel until you see the DVD screen.</li> <li>– Check if the TV is switched on.</li> </ul>
<b>Distorted picture</b>	<ul style="list-style-type: none"> <li>– Sometimes a small amount of picture distortion may appear depending on the disc being played back. This is not a malfunction.</li> </ul>
<b>Completely distorted picture or black/white picture with DVD</b>	<ul style="list-style-type: none"> <li>– Connect DVD Player directly to the TV.</li> <li>– Make sure the disc is compatible with the DVD/Player.</li> <li>– Ensure that the DVD Player's TV Type is set to match that of the Disc and your TV.</li> </ul>
<b>No sound or distorted sound</b>	<ul style="list-style-type: none"> <li>– Adjust the volume.</li> <li>– Check that the speakers are connected correctly.</li> </ul>
<b>No audio at digital output</b>	<ul style="list-style-type: none"> <li>– Check the digital connections.</li> <li>– Check if your receiver can decode MPEG-2 or DTS and if not, please make sure the digital output is set to PCM.</li> <li>– Check if the audio format of the selected audio language matches your receiver capabilities.</li> </ul>
<b>No sound and picture</b>	<ul style="list-style-type: none"> <li>– Check that the RGB/SCART cable is connected to the correct device (See Connecting TV).</li> </ul>
<b>No output from subwoofer during stereo</b>	<ul style="list-style-type: none"> <li>– Check that all speaker settings in the setup menu have been change to small instead of large.</li> </ul>
<b>Disc can't be played</b>	<ul style="list-style-type: none"> <li>– The DVD+R/CD-R must be finalized.</li> <li>– Ensure the disc label is facing up.</li> <li>– Check if the disc is defective by trying another disc.</li> <li>– If you have recorded a Picture CD or MP3 CD yourself, ensure that your disc contains at least 10 pictures or 5 MP3 tracks.</li> <li>– Region code incorrect.</li> </ul>

Visit us at [www.p4c.philips.com](http://www.p4c.philips.com) for service support



## Troubleshooting

English

Problem	Solution
<p><b>Picture freezes momentarily during playback</b></p> <p><b>No return to start-up screen when disc is removed</b></p> <p><b>The player does not respond to the Remote Control</b></p>	<ul style="list-style-type: none"> <li>– Check the disc for fingerprints/scratches and clean with a soft cloth wiping from centre to edge.</li> <li>– Reset the unit by switching the player off, then on again.</li> <li>– Aim the Remote Control directly at the sensor on the front of the player.</li> <li>– Reduce the distance to the player.</li> <li>– Replace the batteries in the Remote Control.</li> <li>– Re-insert the batteries with their polarities (+/- signs) as indicated.</li> </ul>
<p><b>Buttons do not work</b></p>	<ul style="list-style-type: none"> <li>– To completely reset the player, unplug the AC cord from the AC outlet for 5-10 seconds.</li> </ul>
<p><b>Player does not respond to some operating commands during playback.</b></p> <p><b>DVD Player cannot read CDs/DVDs</b></p>	<ul style="list-style-type: none"> <li>– Operations may not be permitted by the disc. Refer to the instructions of the disc jacket.</li> <li>– Use a commonly available cleaning CD/DVD to clean the lens before sending the DVD Player for repair.</li> </ul>
<p><b>Menu items cannot be selected</b></p>	<ul style="list-style-type: none"> <li>– Press STOP twice before selecting System Menu.</li> <li>– Depending on the disc availability, some menu items cannot be selected.</li> </ul>
<p><b>Unable to play DivX movies</b></p>	<ul style="list-style-type: none"> <li>– Check that the DivX file is encoded in 'Home Theater' mode with DivX 5.x encoder.</li> </ul>
<p><b>Unable to select Progressive Scan on/off</b></p>	<ul style="list-style-type: none"> <li>– Check that the output of the video signal is switch to 'YUV'.</li> </ul>
<p><b>No sound during DivX movies playback</b></p>	<ul style="list-style-type: none"> <li>– The audio codec may not be supported by the DVD player.</li> </ul>
<p><b>An MPEG-4 or DivX movies does not repeat</b></p>	<ul style="list-style-type: none"> <li>– Check that file size of the movies does not exceed the file size of the CD disc during burning.</li> </ul>
<p><b>Unable to select the DVD Player's front panel Multichannel and Progressive Scan</b></p>	<ul style="list-style-type: none"> <li>– Multichannel and Progressive Scan on the front panel is LED indicator. They do not function as a button feature.</li> </ul>

Visit us at [www.p4c.philips.com](http://www.p4c.philips.com) for service support

## Glossary

**Analog:** Sound that has not been turned into numbers. Analog sound varies, while digital sound has specific numerical values. These jacks send audio through two channels, the left and right.

**Aspect ratio:** The ratio of vertical and horizontal sizes of a displayed image. The horizontal vs. vertical ratio of conventional TVs. is 4:3, and that of wide-screens is 16:9.

**AUDIO OUT Jacks:** Jacks on the back of the DVD System that send audio to another system (TV, Stereo, etc.).

**Bit Rate:** The amount of data used to hold a given length of music; measured in kilobits per seconds, or kbps. Or, the speed at which you record. Generally, the higher the bit rate, or the higher the recording speed, the better the sound quality. However, higher bit rates use more space on a Disc.

**Chapter:** Sections of a picture or a music piece on a DVD that are smaller than titles. A title is composed of several chapters. Each chapter is assigned a chapter number enabling you to locate the chapter you want.

**Component Video Out Jacks:** Jacks on the back of the DVD System that send high-quality video to a TV that has Component Video In jacks (R/G/B, Y/Pb/Pr, etc.).

**Disc menu:** A screen display prepared for allowing selection of images, sounds, subtitles, multi-angles, etc recorded on a DVD.

**Digital:** Sound that has been converted into numerical values. Digital sound is available when you use the DIGITAL AUDIO OUT COAXIAL or OPTICAL jacks. These jacks send audio through multiple channels, instead of just two channels as analog does.

**DivX 3.11/4.x/5.x:** The DivX codec is a patent-pending, MPEG-4 based video compression technology, developed by DivX Networks, Inc., that can shrink digital video to sizes small enough to be transported over the internet, while maintaining high visual quality.

**Dolby Digital:** A surround sound system developed by Dolby Laboratories containing up to six channels of digital audio (front left and right, surround left and right, center and subwoofer).

**DTS:** Digital Theatre Systems. This is a surround sound system, but it is different from Dolby Digital. The formats were developed by different companies.

**JPEG:** A very common digital still picture format. A still-picture data compression system proposed by the Joint Photographic Expert Group, which features small decrease in image quality in spite of its high compression ratio.

**MP3:** A file format with a sound data compression system. "MP3" is the abbreviation of Motion Picture Experts Group 1 (or MPEG-1) Audio Layer 3. By using MP3 format, one CD-R or CD-RW can contain about 10 times as much data volume as a regular CD can.

**Multichannel:** DVD is specified to have each sound track constitute one sound field. Multichannel refers to a structure of sound tracks having three or more channels.

**Parental Control:** A function of the DVD to limit playback of the disc by the age of the users according to the limitation level in each country. The limitation varies from disc to disc; when it is activated, playback will be prohibited if the software's level is higher than the user-set level.

**PCM (Pulse Code Modulation):** A system for converting analog sound signal to digital signal for later processing, with no data compression used in conversion.

**Playback control (PBC):** Refers to the signal recorded on video CDs or SVCDs for controlling reproduction. By using menu screens recorded on a Video CD or SVCD that supports PBC, you can enjoy interactive-type software as well as software having a search function.

**Progressive Scan:** It displays all the horizontal lines of a picture at one time, as a signal frame. This system can convert the interlaced video from DVD into progressive format for connection to a progressive display. It dramatically increases the vertical resolution.

**Region code:** A system for allowing discs to be played back only in the region designated beforehand. This unit will only play discs that have compatible region codes. You can find the region code of your unit by looking on the product label. Some discs are compatible with more than one region (or ALL regions).

**S-Video:** Produces a clear picture by sending separate signals for the luminance and the color. You can use S-Video only if your TV has S- video In jack.

**Super Audio CD (SACD):** This audio format is based upon the current CD standards but includes a greater amount of information that provides higher quality sound. There are three types of discs: single layer, double layer and hybrid discs. The hybrid disc contains both standard audio CD and Super Audio CD information.

**Surround:** A system for creating realistic three-dimensional sound fields full of realism by arranging multiple speakers around the listener.

**Title:** The longest section of a picture or music feature on DVD, music, etc., in video software, or the entire album in audio software. Each title is assigned a title number enabling you to locate the title you want.

**VIDEO OUT jack:** Jack on the back of the DVD System that sends video to a TV.