

Register your product and get support at
www.philips.com/welcome

Immersive
3000 series



Quick start guide

PHILIPS



EN Before using your product, read all accompanying safety information

RU Перед тем как использовать это изделие, ознакомьтесь с информацией, касающейся безопасности

UK Перед початком роботи прочитайте всю супутню інформацію про безпеку

HI अपने उत्पाद का उपयोग करने के पहले, साथ वाली सभी सुरक्षा जानकारी को पढ़ें

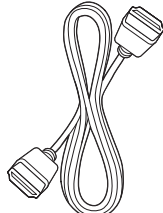
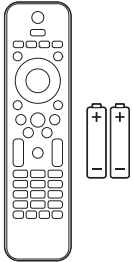

HDMI

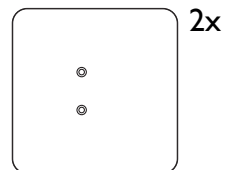
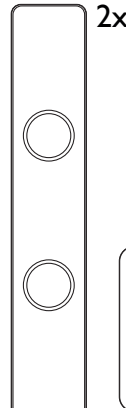
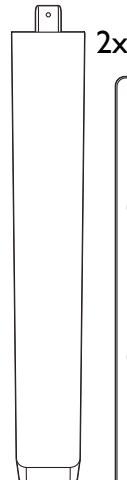
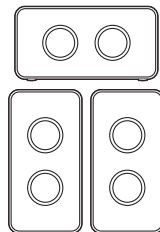
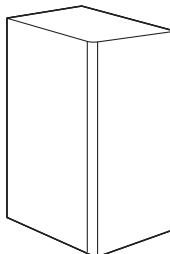
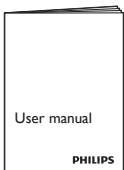
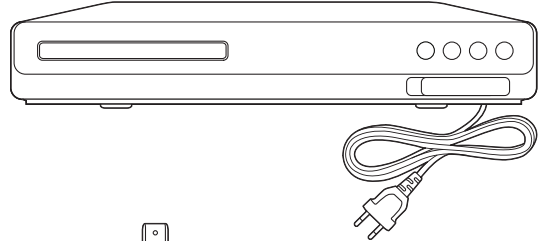

1

EN Stand mount the speakers

RU Установите динамики на подставки

UK Встановлення гучномовців на підставку

HI स्पीकर्स को खड़ा करें

1

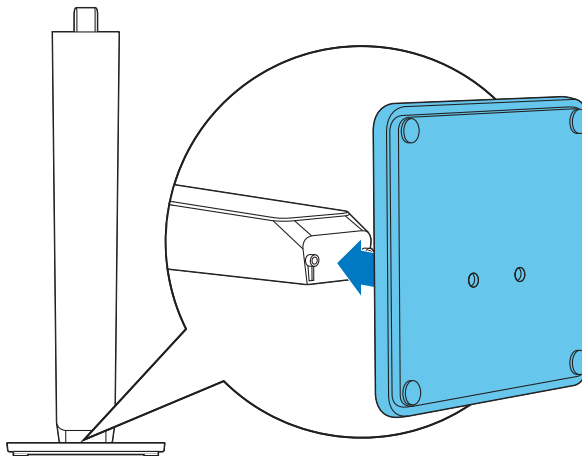

2

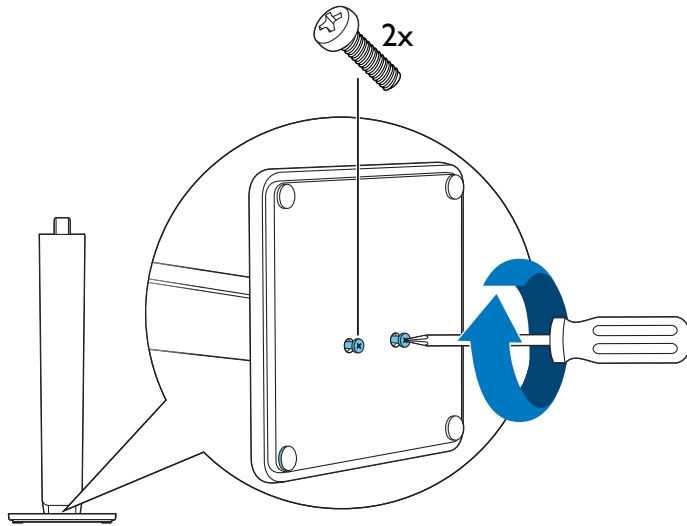

3

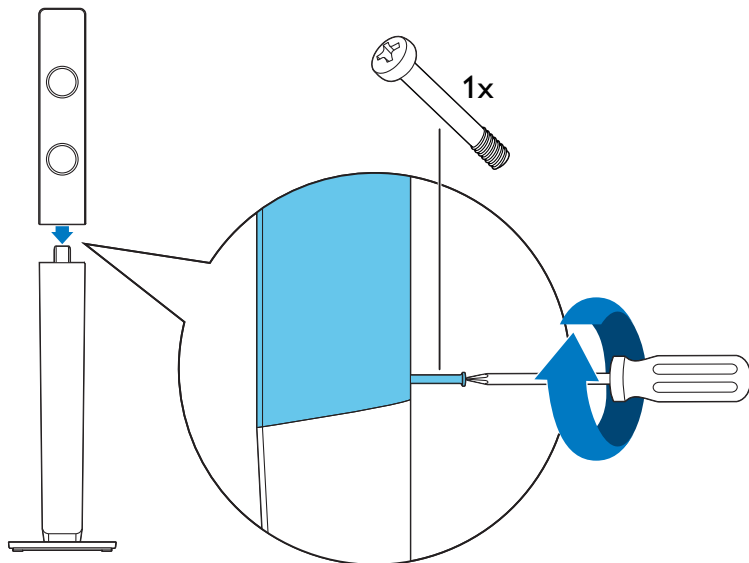

2

EN Connect the home theater

RU Подключите домашний кинотеатр

UK Під'єднання системи домашнього кінотеатру

HI होम थिएटर को कनेक्ट करें

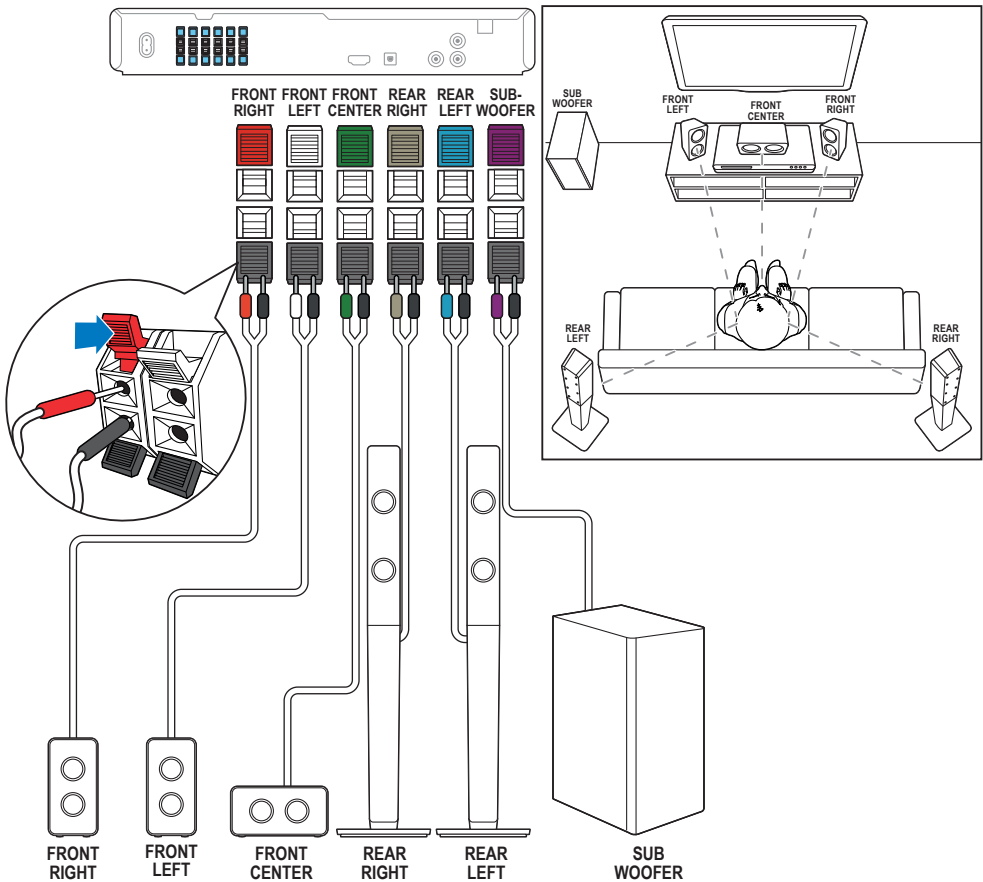

3

EN Connect to TV in one of these ways

RU Выполните подключение к ТВ одним из следующих способов

UK Під'єднання телевізора в один із поданих способів

HI इन तरीकों में से एक के द्वारा TV से कनेक्ट करें

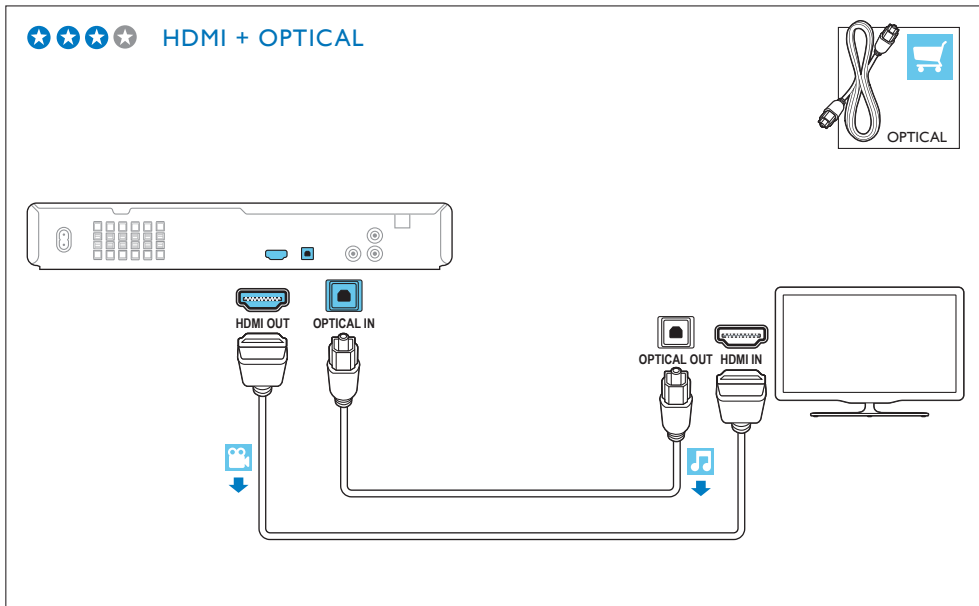

★ ★ ★ ★ HDMI + AUDIO L/R

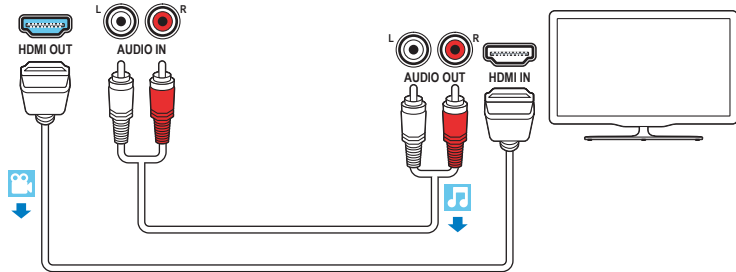
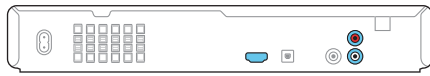

★ ★ ★ ★ VIDEO + AUDIO L/R

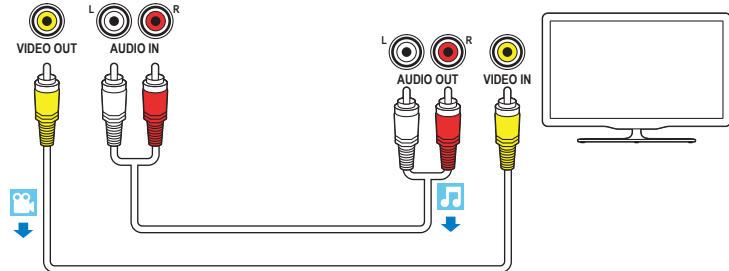
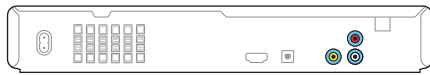

4

EN Switch on the home theater

RU Включите домашний кинотеатр

UK Увімкнення системи домашнього кінотеатру

HI होम थिएटर को स्विच ऑन करें

1

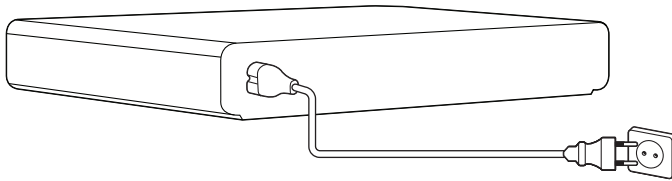

2

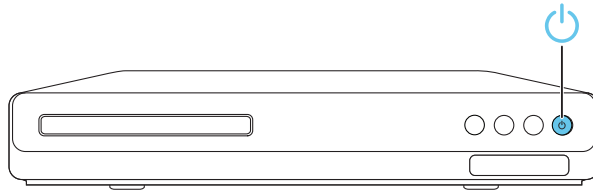

3

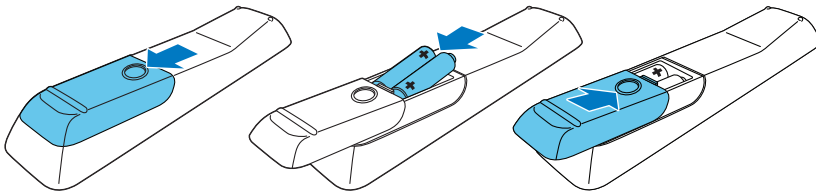

5

EN Complete the first time setup

RU Выполните первоначальную настройку

UK Виконання перших налаштувань

HI पहली बार के सेटअप को पूर्ण करें

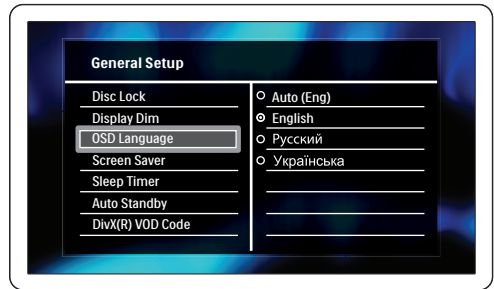
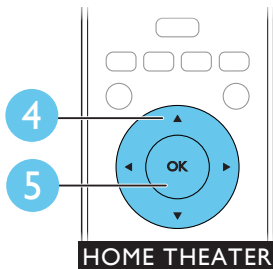
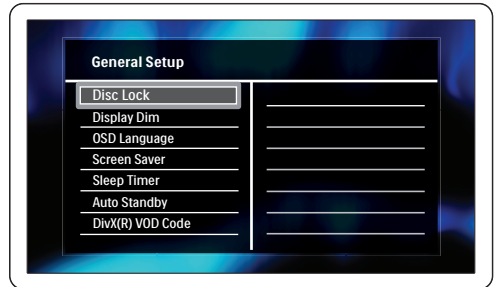
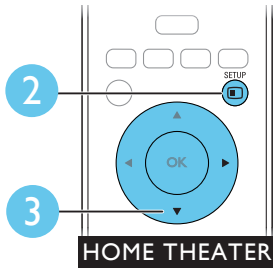
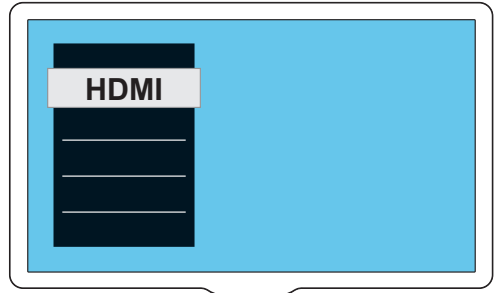
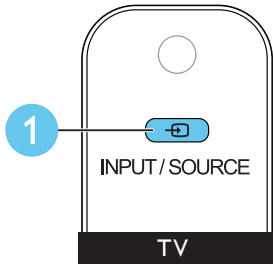

6

EN Use your home theater

RU Домашний кинотеатр готов к использованию

UK Використання системи домашнього кінотеатру

HI अपने होम थिएटर का उपयोग करें

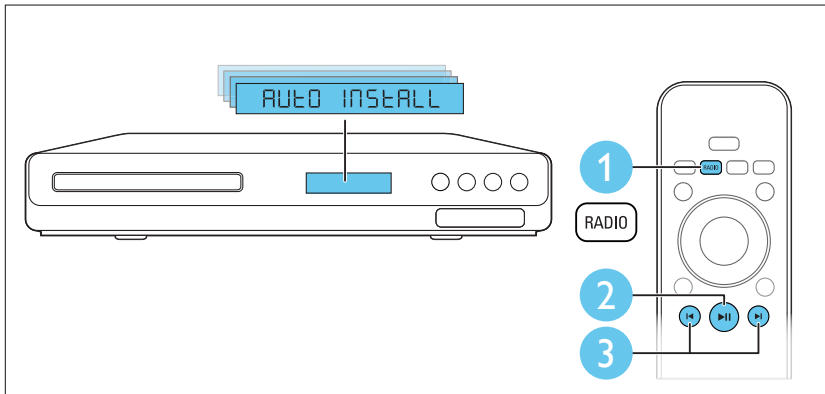
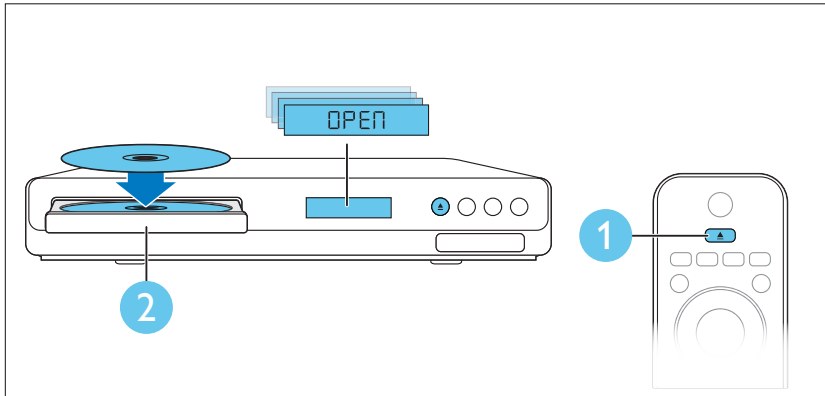

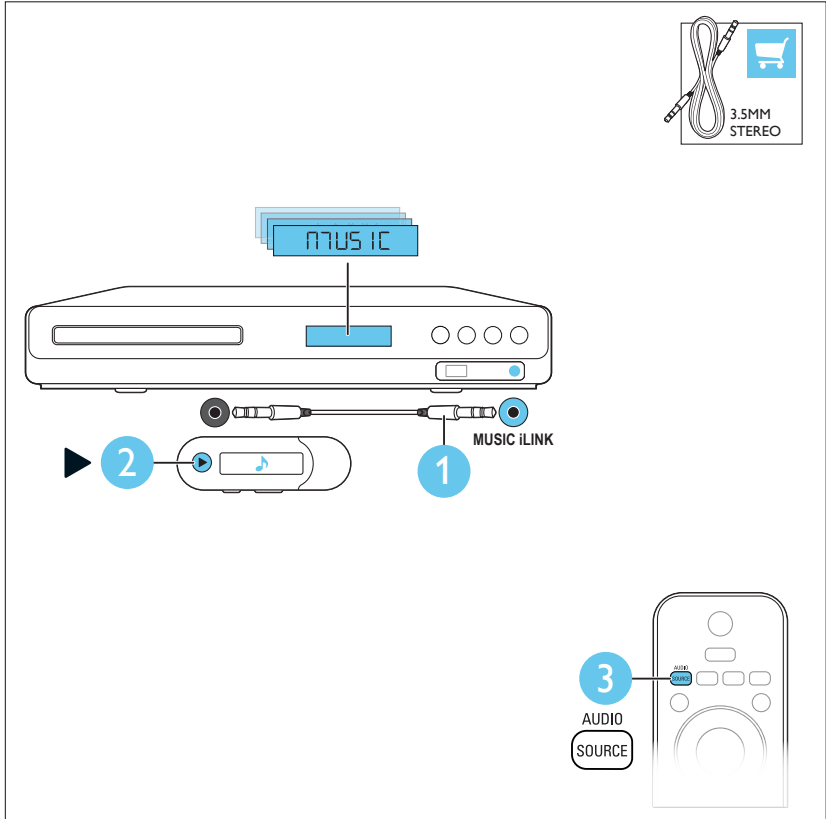
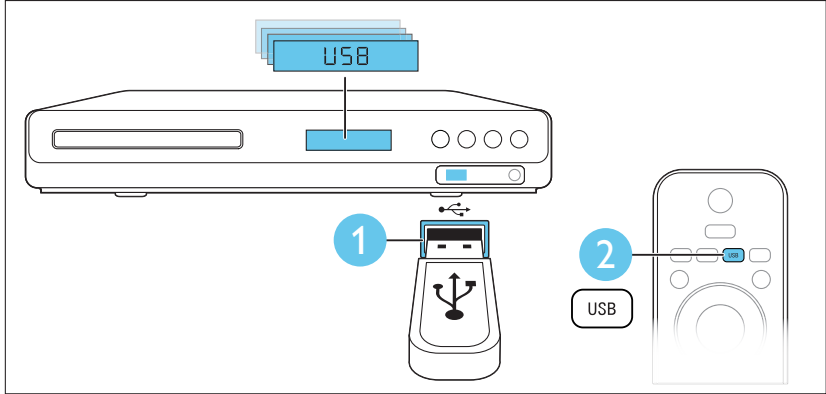



EN For more information about using this product visit www.philips.com/support

RU Дополнительные сведения об использовании этого изделия см. на веб-сайте www.philips.com/support

UK Для отримання додаткових відомостей щодо використання цього виробу відвідайте веб-сайт www.philips.com/support

HI उत्पाद के उपयोग संबंधी अधिक जानकारी के लिए www.philips.com/support पर जाएं



www.philips.com/support



Non-contractual images. / Images non contractuelles. / Außervertragliche Bilder.

All registered and unregistered trademarks are property of their respective owners.

Specifications are subject to change without notice
Trademarks are the property of Koninklijke Philips Electronics N.V. or their respective owners
2012 © Koninklijke Philips Electronics N.V. All rights reserved
www.philips.com
sgsn_1151/51_v1

