

DVD VIDEO PLAYER

DVP3126K

Thank you for choosing Philips.

Need help fast?

Read your User's Manual first for quick tips that make using your Philips product more enjoyable.

If you have read your instructions and still need assistance, you may access our online help at www.philips.com/support



PHILIPS

The apparatus shall not be exposed to dripping or splashing and that no objects filled with liquids, such as vases, shall be placed on apparatus.

Due to the inconsistency of disc formats provided by various disc manufacturers, your DVD system may require a playability enhancement or upgrade. As DVD technology advances, these enhancements will become common and will be easy to complete.
Go to www.philips.com/support for software upgrade.

This product incorporates copyright protection technology that is protected by method claims of certain U.S. patents and other intellectual property rights owned by Macrovision Corporation and other rights owners. Use of this copyright protection technology must be authorized by Macrovision Corporation, and is intended for home and other limited viewing uses only unless otherwise authorized by Macrovision Corporation. Reverse engineering or disassembly is prohibited.

'CONSUMERS SHOULD NOTE THAT NOT ALL HIGH DEFINITION TELEVISION SETS ARE FULLY COMPATIBLE WITH THIS PRODUCT AND MAY CAUSE ARTIFACTS TO BE DISPLAYED IN THE PICTURE. IN CASE OF 525 OR 625 PROGRESSIVE SCAN PICTURE PROBLEMS, IT IS RECOMMENDED THAT THE USER SWITCH THE CONNECTION TO THE 'STANDARD DEFINITION' OUTPUT. IF THERE ARE QUESTIONS REGARDING TV SET COMPATIBILITY WITH THIS MODEL 525p AND 625p DVD PLAYER, PLEASE CONTACT OUR CUSTOMER SERVICE CENTER.'

Index

English ----- 6

中文 (繁體) ----- 44

Bahasa Melayu ----- 82

English

中文 (繁體)

Bahasa Melayu

General Information

Environmental Information

All unnecessary packaging has been omitted. The packaging has been made easy to separate into two materials; cardboard (box) and polyethylene (bags, protective foam sheet).

Your DVD player consists of materials which can be recycled and reused if disassembled by a specialised company. Please observe the local regulations regarding the disposal of packaging materials, exhausted batteries and old equipment.

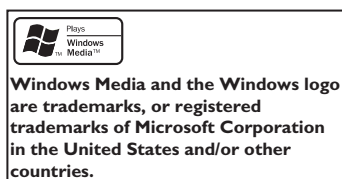
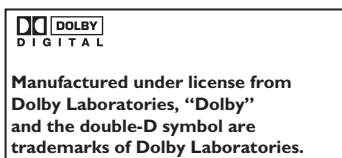

Laser Safety

This unit employs a laser. Due to possible eye injury, only a qualified service person should remove the cover or attempt to service this device.

NOTE:

Pictures shown maybe different between countries.

CAUTION:

WARNING LOCATION: ON THE BACKPLATE OF THE SET

NEVER MAKE OR CHANGE CONNECTIONS WITH THE POWER SWITCHED ON.

Specifications are subject to change without notice. Trademarks are the property of Koninklijke Philips Electronics N.V. or their respective owners.

For Customer Use:
Read carefully the information located at the bottom or rear of your DVD Video player and enter below the Serial No. Retain this information for future reference.

Model No. DVP 3126K
Serial No. _____

LASER

Type	Semiconductor laser InGaAlP (DVD) AlGaAs (CD)
Wave length	658 nm (DVD) 790 nm (CD)
Output Power	7.0 mW (DVD) 10.0 mW (VCD/CD)
Beam divergence	60 degrees

Language Code

Abkhazian	6566	Inupiaq	7375	Pushto	8083
Afar	6565	Irish	7165	Russian	8285
Afrikaans	6570	Íslenska	7383	Quechua	8185
Amharic	6577	Italiano	7384	Raeto-Romance	8277
Arabic	6582	Ivrit	7269	Romanian	8279
Armenian	7289	Japanese	7465	Rundi	8278
Assamese	6583	Javanese	7486	Samoan	8377
Avestan	6569	Kalaallisut	7576	Sango	8371
Aymara	6589	Kannada	7578	Sanskrit	8365
Azerhijani	6590	Kashmiri	7583	Sardinian	8367
Bahasa Melayu	7783	Kazakh	7575	Serbian	8382
Bashkir	6665	Kernewek	7587	Shona	8378
Belarusian	6669	Khmer	7577	Shqip	8381
Bengali	6678	Kinyarwanda	8287	Sindhi	8368
Bihari	6672	Kirghiz	7589	Sinhalese	8373
Bislama	6673	Komi	7586	Slovensky	8373
Bokmål, Norwegian	7866	Korean	7579	Slovenian	8376
Bosanski	6683	Kuanyama; Kwanyama	7574	Somali	8379
Brezhoneg	6682	Kurdish	7585	Sotho; Southern	8384
Bulgarian	6671	Lao	7679	South Ndebele	7882
Burmese	7789	Latina	7665	Sundanese	8385
Castellano, Español	6983	Latvian	7686	Suomi	7073
Catalán	6765	Letzeburgesch;	7666	Swahili	8387
Chamorro	6772	Limburgan; Limburger	7673	Swati	8383
Chechen	6769	Lingala	7678	Svenska	8386
Chewa; Chichewa; Nyanja	7889	Lithuanian	7684	Tagalog	8476
中文	9072	Luxembourgish;	7666	Tahitian	8489
Chuang; Zhuang	9065	Macedonian	7775	Tajik	8471
Church Slav; Slavonic	6785	Malagasy	7771	Tamil	8465
Chuvash	6786	Magyar	7285	Tatar	8484
Corsican	6779	Malayalam	7776	Telugu	8469
Česky	6783	Maltese	7784	Thai	8472
Dansk	6865	Manx	7186	Tibetan	6679
Deutsch	6869	Maori	7773	Tigrinya	8473
Dzongkha	6890	Marathi	7782	Tonga (Tonga Islands)	8479
English	6978	Marshallese	7772	Tsonga	8483
Esperanto	6979	Moldavian	7779	Tswana	8478
Estonian	6984	Mongolian	7778	Türkçe	8482
Euskara	6985	Nauru	7865	Turkmen	8475
Ελληνικά	6976	Navaho; Navajo	7886	Twi	8487
Faroesse	7079	Ndebele, North	7868	Uighur	8571
Français	7082	Ndebele, South	7882	Ukrainian	8575
Frysk	7089	Ndonga	7871	Urdu	8582
Fijian	7074	Nederlands	7876	Uzbek	8590
Gaelic; Scottish Gaelic	7168	Nepali	7869	Vietnamese	8673
Gallegan	7176	Norsk	7879	Volapuk	8679
Georgian	7565	Northern Sami	8369	Walloon	8765
Gikuyu; Kikuyu	7573	North Ndebele	7868	Welsh	6789
Guarani	7178	Norwegian Nynorsk;	7878	Wolof	8779
Gujarati	7185	Occitan; Provençal	7967	Xhosa	8872
Hausa	7265	Old Bulgarian; Old Slavonic	6785	Yiddish	8973
Herero	7290	Oriya	7982	Yoruba	8979
Hindi	7273	Oromo	7977	Zulu	9085
Hiri Motu	7279	Ossetian; Ossetic	7983		
Hrvatski	6779	Pali	8073		
Ido	7379	Panjabi	8065		
Interlingua (International)	7365	Persian	7065		
Interlingue	7365	Polski	8076		
Inuktitut	7385	Português	8084		

Contents

Care and Safety Information	
Setup	8
Cleaning discs	8
General Information	
Accessories supplied	9
Region codes	9
Connections	
Connecting to television	10-11
Using Composite Video jacks (CVBS)	10
Using Component Video jacks (YPbPr)	10
Using an accessory RF modulator	11
Connecting the power cord	12
Optional connections	
Connecting to a Multi-channel Receiver	12
Receiver has a Dolby Digital decoder	12
Connecting to a stereo system	13
Stereo system has right/left Audio In jacks	13
Connecting to a digital AV receiver	13
Receiver has a PCM, Dolby Digital or MPEG decoder	13
Product Overview	
Front and Rear panels	14
Remote Control	15
Getting Started	
Step 1: Inserting Batteries	16
Using the remote control to operate the system	16
Step 2: Finding your viewing channel	16
Step 3: Setting up Progressive Scan feature	17
Step 4: Selecting the matching color system	18
Step 5: Setting the language	19
On-screen display (OSD) language	19
Audio, Subtitle and DVD menu languages	19
Playback from Disc	
Playable discs	20
Supported formats	20
Playback Features	
Starting disc playback	21
Basic playback controls	21
Pausing playback	21
Selecting title/chapter/track	21
Stopping playback	21
Operations for video playback	22
Using the Disc Menu	22
Zooming in	22
Resuming playback from the last stopped point	22
Slow Motion	22
Forward / Reverse Searching	22

Contents

English

Viewing the disc playback information	23-24
Title/Chapter/Track selection	23
Time Search	23
Angle	23
Repeat play mode	24
Repeating a section within a chapter/track	24
Special DVD Features	25
Playing a Title	25
Changing the Audio Language	25
Subtitles	25
Special VCD and SVCD Feature	25
Playback Control (PBC)	25
Playing MP3/WMA/JPEG/Kodak/Fuji Picture CD	26-27
General Operation	26
Playback selection	26
Zoom picture (JPEG)	27
Playback with multi-angles (JPEG)	27
Karaoke Operations	
Playing Karaoke disc	28
General Operation	28
Vocal	28
Karaoke	28
DVD Menu Options	
Using the Language setup menu	29
OSD Language	29
Subtitle / Audio / DVD Menu	29
Using the Video setup menu	30-32
Setting the Aspect Ratio	30
View Mode	31
TV System	31
Video Out	31
Smart Picture	32
Using the Audio setup menu	33-34
Front / Center / Surround Speakers	33
Subwoofer	33
Digital Output	34
Night Mode	34
Down Sampling	34
Using the Rating setup menu	35-36
Rating level settings	35-36
Changing the Password	36
Using the Misc (Miscellaneous) setup menu	37-38
Restoring to the original settings	37
Volume Control	38
Speakers Delay	38
Others	
Software upgrade	39
Troubleshooting	40~41
Specifications	42
Glossary	43

Care and Safety Information

DANGER!

High voltage! Do not open the device. You run the risk of getting an electric shock.

The machine does not contain any user-serviceable parts. Please leave all maintenance work to qualified personnel.

Setup

Finding a suitable location

- Place the set on a flat, hard and stable surface. Do not place the set on a carpet.
- Do not put any equipment or heavy objects on top of the set.
- Do not position the set on top of other equipment that might heat it up (such as receiver or amplifier).
- Do not put anything under the set (such as CDs, magazines).
- Install this unit near the AC outlet and where the AC power plug can be reached easily.

Space for ventilation

- Place the apparatus in a location with adequate ventilation to prevent internal heat build up. Allow at least 10 cm (4.0") clearance from the rear and the top of the set and 5cm (2.0") from the left and right to prevent overheating.

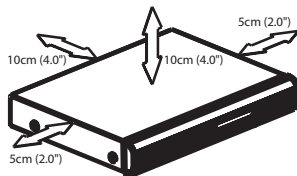

Avoid high temperatures, moisture, water and dust

- Apparatus shall not be exposed to dripping or splashing.
- Do not place any sources of danger on the apparatus (such as liquid filled objects, lighted candles).

Cleaning discs

Some problems occur because the disc inside the player is dirty (frozen picture, sound disruptions, picture distortions).

To avoid these problems, discs should be cleaned on a regular basis.

To clean a disc, use a micro fibre cleaning cloth and wipe the disc from the center to the edge in a straight line.

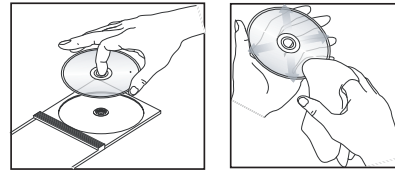

CAUTION!

Do not use solvents such as benzene, thinner, commercially available cleaners, or anti-static sprays intended for analog discs. Since the optical unit (laser) of the DVD player operates at a higher power than regular DVD or CD players, cleaning CDs intended for DVD or CD players may damage the optical unit (laser). Therefore, refrain from using a cleaning CD.

General Information

Accessories supplied

Composite video cable (yellow) and Audio cables (white, red)

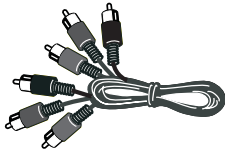

Remote control and two AAA batteries

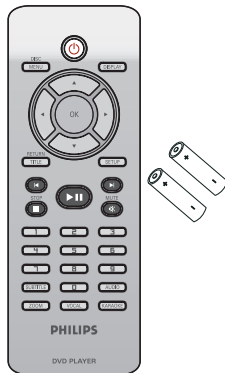

AC Power Cable



Region codes

This DVD player is designed to support the Region Management System. Check the regional code number on the disc package. If the number does not match the player's region number (see table below), the player may be unable to playback the disc.

Tips:

- It may not be possible to play CD-R/RW or DVD-R/RW in all cases due to the type of disc or condition of the recording.
- If you are having trouble playing a certain disc, remove the disc and try a different one. Improper formatted disc will not played on this DVD player.

Region	Discs that can be played	
U.S.A. and Canada regions		
U.K and Europe regions		
Asia Pacific, Taiwan, Korea		
Australia, New Zealand, Latin America		
Russia and India regions		
China, Calcos Islands, Walls and Futuna Islands		

Connections

Connecting to television

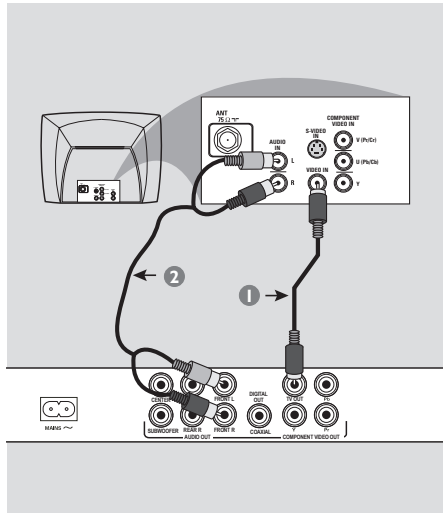

IMPORTANT!

- You only need to make one video connection from the following options, depending on the capabilities of your television.
- Connect the DVD player directly to the television.

Using Composite Video jacks (CVBS)

- 1 Use the composite video cable (yellow) to connect the DVD player's **TV OUT** (CVBS) jack to the video input jack (or labeled as A/V In, Video In, Composite or Baseband) on the television (cable supplied).
- 2 To hear sound of this DVD player through your television, use the audio cables (white/red) to connect FRONT (L/R) AUDIO OUT jacks of the DVD player to the corresponding AUDIO IN jacks on the television (cable supplied).

TIPS: Before making or changing any connections, make sure that all the devices are disconnected from the power outlet.

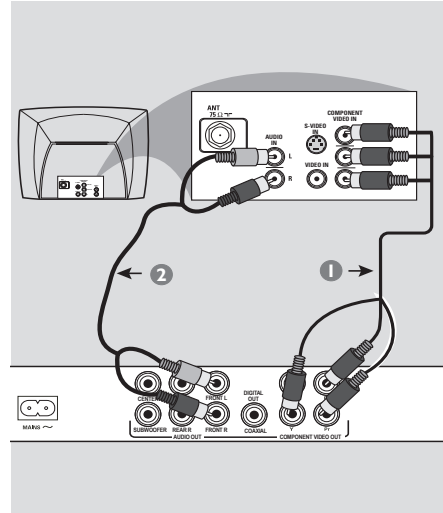

IMPORTANT!

- The progressive scan video quality is only possible when using YPbPr and a progressive scan television is required.

Using Component Video jacks (YPbPr)

- 1 Use the component video cables (red/blue/green) to connect the DVD player's **YPbPr** jacks to the component video input jacks (or labeled as YPbPr) on the television (cable not supplied).
- 2 To hear sound of this DVD player through your television, use the audio cables (white/red) to connect FRONT (L/R) AUDIO OUT jacks of the DVD player to the corresponding AUDIO IN jacks on the television (cable supplied).
- 3 Proceed to page 17 for detailed progressive scan setup.

Connections (continued)

English

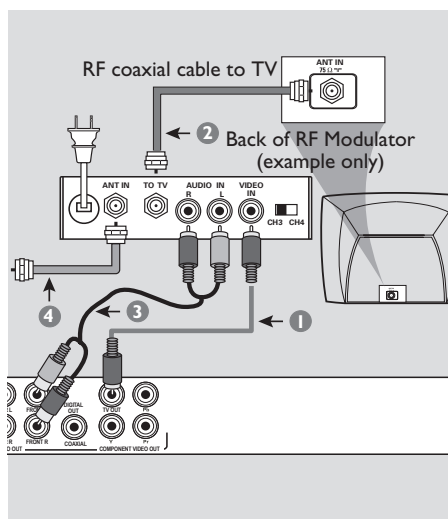

IMPORTANT!

– If your television only has a single Antenna In jack (or labeled as 75 ohm or RF In,) you will need an RF modulator in order to view the DVD playback on the television. See your electronics retailer or contact Philips for details on RF modulator availability and operations.

Using an accessory RF modulator

- 1 Use the composite video cable (yellow) to connect the DVD player's **TV OUT** (CVBS) jack to the video input jack on the RF modulator.
- 2 Use the RF coaxial cable (not supplied) to connect **ANTENNA OUT** or **TO TV** jack on the RF modulator to the **ANTENNA IN** jack on the television.

- 3 To hear sound of this DVD player through your TV, use the audio cables (white/red) to connect **FRONT (L/R) AUDIO OUT** jacks of the DVD player to the corresponding **AUDIO IN** jacks on the RF modulator (cable supplied).
- 4 Connect the Antenna or Cable TV service signal to the **ANTENNA IN** or **RF IN** jack on the RF modulator. (It may have been connected to your TV previously. Disconnect it from the TV).

TIPS: Before making or changing any connections, make sure that all the devices are disconnected from the power outlet.

11

Connections (continued)

Connecting the power cord

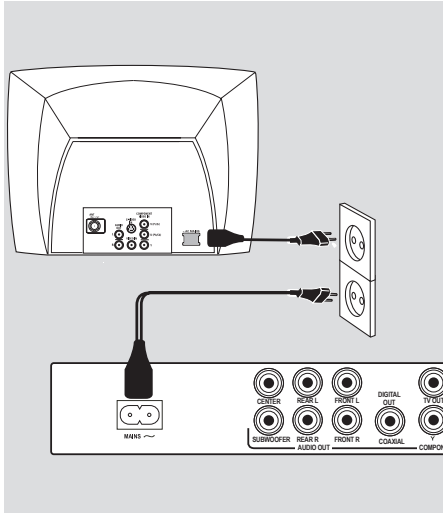

After everything is connected properly, plug in the AC power cord to the power outlet.

Never make or change any connections with the power switched on.

When no disc is loaded, press **STANDBY ON** on the DVD player front panel. “- - -” may appear on the display panel.

Connecting to a Multi Channel Receiver

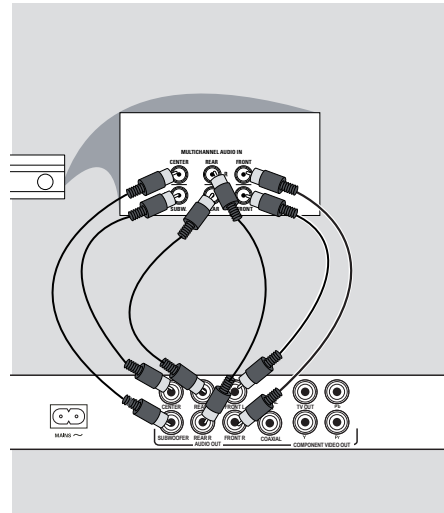

Receiver has a Dolby Digital decoder

- 1 Select one of the video connections (CVBS VIDEO IN or COMPONENT VIDEO IN) depending on the options available on your television.
- 2 Connect the Audio Out Left and Right jack for Front and Rear speakers to the corresponding input jacks on your receiver (cable not supplied).
- 3 Connect the Audio Out for Center speaker and Subwoofer to the corresponding inputs on your receiver (cable not supplied).

TIPS: Before making or changing any connections, make sure that all the devices are disconnected from the power outlet.

Optional connections

Connecting to a stereo system

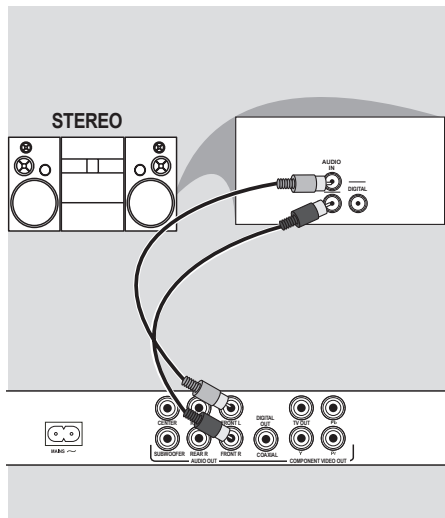

Stereo system has right/ left Audio In jacks

- 1 Select one of the video connections (CVBS VIDEO IN or COMPONENT VIDEO IN) depending on the options available on your television.
- 2 Use the audio cables (white/red) to connect FRONT (L/R) AUDIO OUT jacks of the DVD Player to the corresponding AUDIO IN jacks on the stereo system (cable supplied).

Connecting to a digital AV receiver

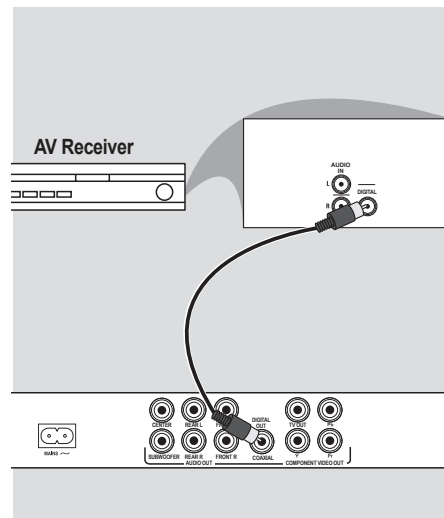

Receiver has a PCM, Dolby Digital or MPEG decoder

- 1 Select one of the video connections (CVBS VIDEO IN or COMPONENT VIDEO IN) depending on the options available on your television.
- 2 Connect the COAXIAL jack of the DVD player to the corresponding Digital Audio In jack on your receiver (cable not supplied).
- 3 Set the DVD player's digital output to PCM-Only or ALL depending on the capabilities of your receiver (see page 34 {Digital Output}).

Tip:

– If the audio format of the Digital Output does not match the capabilities of your receiver, the receiver will produce a strong, distorted sound or no sound at all.

TIPS: Before making or changing any connections, make sure that all the devices are disconnected from the power outlet.

Product Overview

Front and Rear Panels

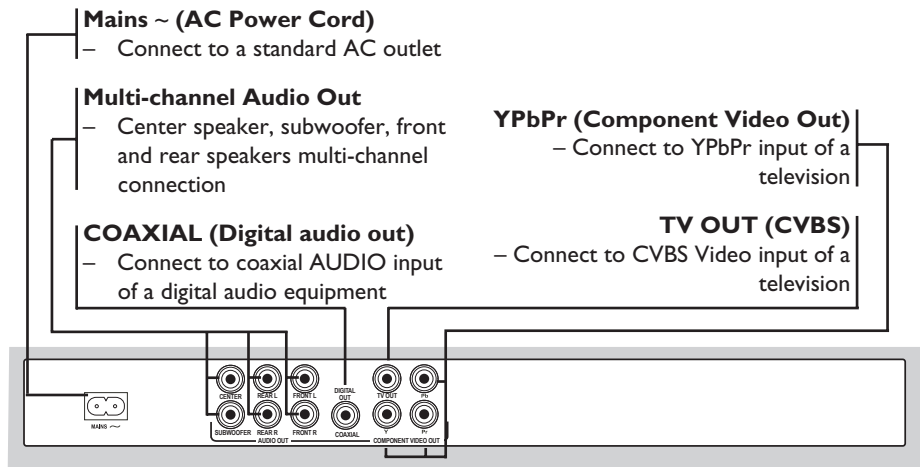
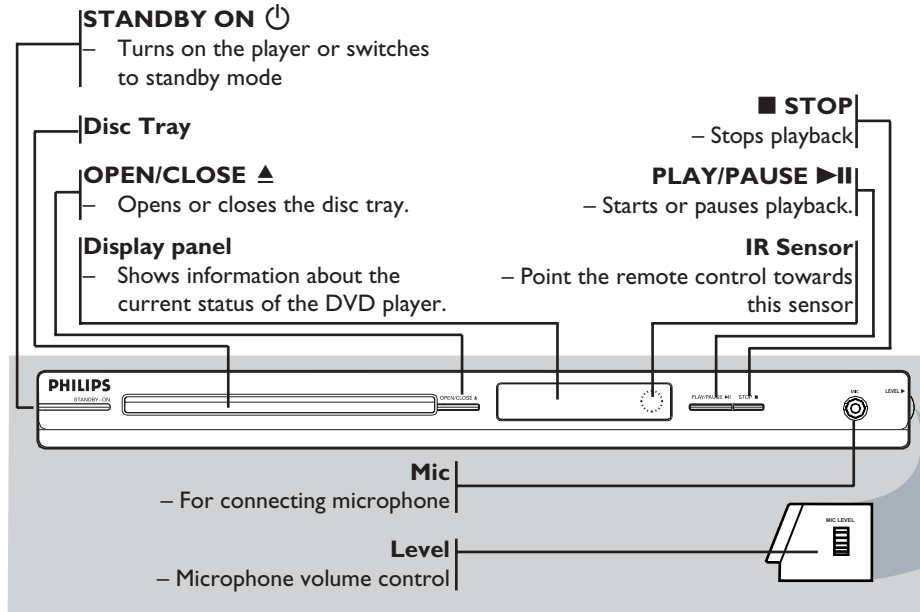

Product Overview (continued)

Remote Control

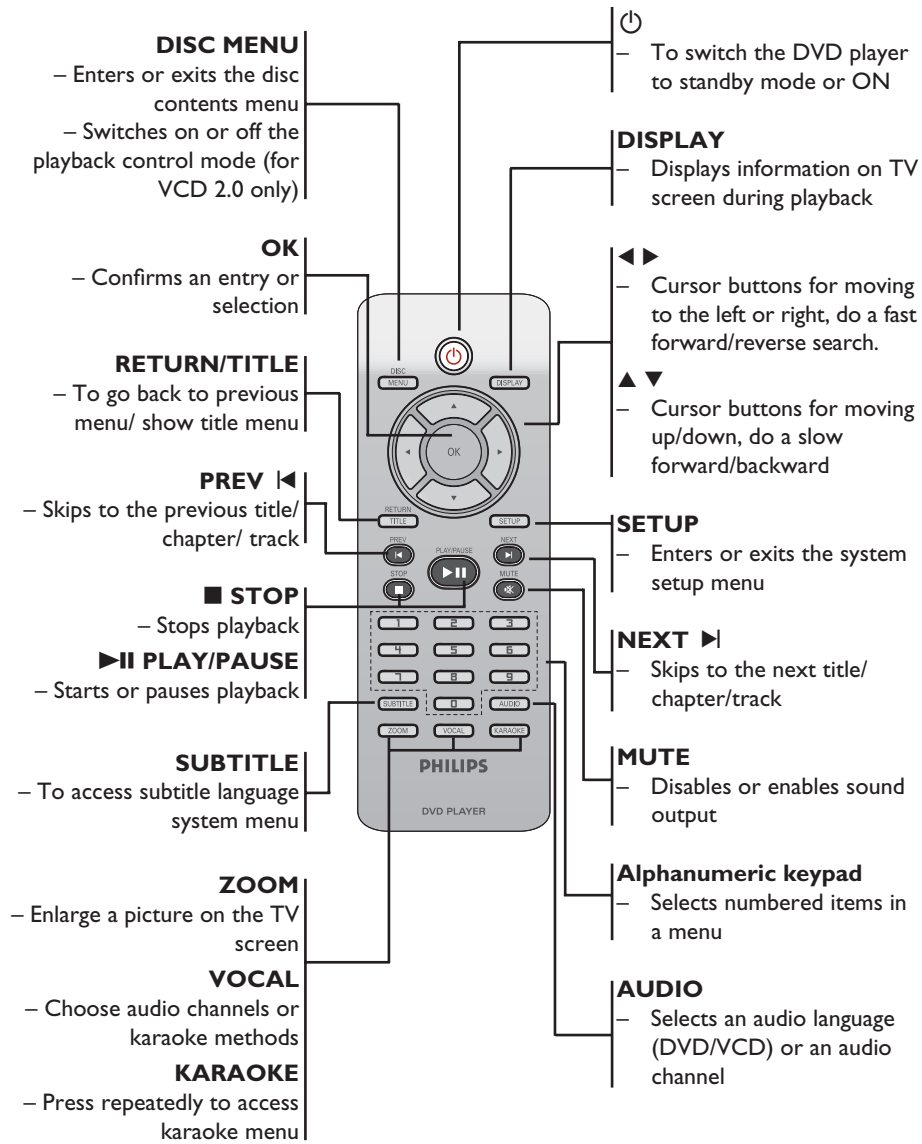

English

Getting Started

Step 1 : Inserting Batteries

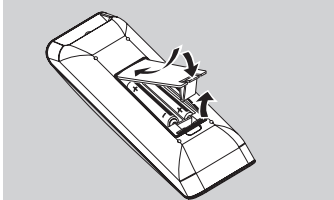

- ① Open the battery compartment.
- ② Insert two batteries type R03 or AAA, following the indications (+ -) inside the compartment.
- ③ Close the cover.

CAUTION!

- Remove batteries if they are exhausted or if the remote is not to be used for a long time.
- Do not use old and new or different types of batteries in combination.
- Batteries contain chemical substances, so they should be disposed of properly.

Using the remote control to operate the system

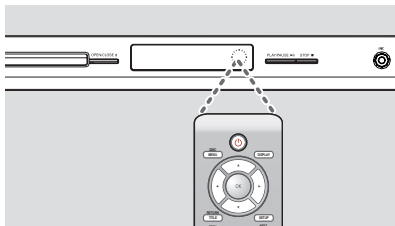

- ① Aim the remote control directly at the remote sensor (IR) on the front panel.
- ② Do not put any objects between the remote control and the DVD player while operating the DVD player.

Step 2 : Finding your viewing channel

- ① Press **STANDBY-ON**  on the DVD player to turn it on.
- ② Turn on the TV and set it to the correct video-in channel. You should see the blue DVD background screen.
 - Usually these channel are between the lowest and highest channels and may be called FRONT, A/V IN, VIDEO. See your TV's manual for more details.
 - Or, you may go to channel 1 on your TV, then press the Channel down button repeatedly until you see the Video In channel.
 - Or, the TV remote control may have a button or turn that chooses different video modes.
 - Or, set the TV to channel 3 or 4 if you are using an RF modulator.
- ③ If you are using external equipment, (such as audio system or receiver), turn it on and select the appropriate input source for the DVD player output. Refer to the equipment user's manual for detail.

Getting Started (continued)

Step 3 : Setting up Progressive Scan feature

(for Progressive Scan TV only)

The progressive scan displays twice the number of frames per seconds than interlaced scanning (ordinary normal TV system). With nearly double the number of lines, progressive scan offers higher picture resolution and quality.

Before you start...

- Ensure that you have connected this DVD player to a progressive scan TV using the Y Pb Pr connection (see page 10).
- Ensure that you have completed the basic installation and set-up.

- 1 Turn on your TV and set to interlace mode (refer to your TV user manual).
- 2 Press **STANDBY ON**  on the remote control to turn on the DVD player.
- 3 Select the correct video-in channel.
→ The DVD background menu appears.
- 4 Press **SETUP**.
- 5 Press **▲ ▼** to select { **Video** }, then press **▶**.

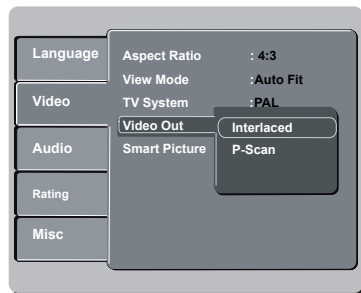

- 6 Press **▲ ▼** repeatedly to select { **Video Out** }, then press **▶**.

- 7 Select { **P-Scan** }, then press **OK** to confirm.
→ The menu will appear on the TV.

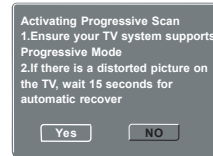

- 8 Press **◀** to highlight { **Yes** } and press **OK** to confirm.
- 9 Turn on your TV progressive scan mode (refer to your TV user manual).
→ The menu will appear on the TV.

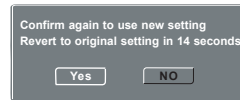

- 10 Press **◀** to highlight { **Yes** } and press **OK** to confirm.
→ The setup is now completed and you can start enjoy the high quality picture.

To deactivate Progressive Scan manually:

- Wait for 15 seconds for the auto recovery.
- OR**
- 1 Press **OPEN/CLOSE** **▲** on the DVD player to open the disc tray.
- 2 Press **numeric keypad '1'** on the remote control for few seconds.
→ The DVD background screen appears.

Tip:

– There are some progressive scan TVs and High-Definition TVs that are not fully compatible with this unit, resulting in the unnatural picture when playing back a DVD VIDEO disc in the progressive scan mode. In such a case, turn off the progressive scan feature on both the DVD player and your TV.

TIPS: The underlined option is the factory default setting.
Press **◀** to go back to previous menu item. Press **SETUP** to exit the menu item.

Getting Started (continued)

Step 4 : Selecting the matching color system

The color system of the DVD player, disc and TV should match in order for the disc to play. Before changing the TV system, determine the color system of your TV.

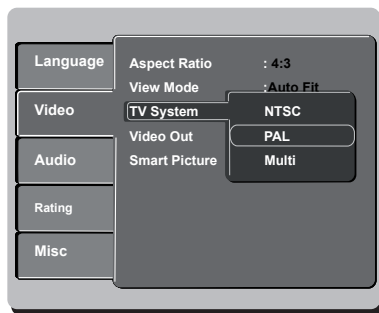

- 1 Press **SETUP**.
- 2 Press **▲ ▼** to select { **Video** }, then press **▶**.
- 3 Press **▲ ▼** repeatedly to select { **TV System** }, then press **▶**.
- 4 Use **▲ ▼** to select one of the options below:
 - { **PAL** }

Select this if the connected TV has the PAL colour system. It will change the video signal of an NTSC disc and output it to PAL format.

 - { **NTSC** }

Select this if the connected TV has the NTSC colour system. It will change the video signal of a PAL disc and output it to NTSC format.

 - { **Multi** }

Select this if the connected TV is compatible with both NTSC and PAL (multi-system). The output format will be in accordance with the video signal of the disc.

TIPS: The underlined option is the factory default setting.
Press **◀** to go back to previous menu item. Press **SETUP** to exit the menu item.

- 5 Select a setting and press **OK**.
→ Follow the instructions show on the TV to confirm the selection (if any).

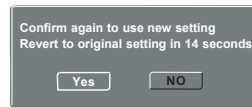

- 6 Press **◀** to highlight { **Yes** } and press **OK** to confirm.

To reset to default TV color system:

- Wait for 15 seconds for the auto recovery.
- OR**
- 1 Press **OPEN/CLOSE ▲** on the DVD player to open the disc tray.
 - 2 Press **numeric keypad '3'** on the remote control for few seconds.
→ The DVD background menu appears.

Tips:

- Before changing the current TV colour setting, ensure that your TV supports the 'selected TV System'.
- If there is no proper picture on your TV, wait for 15 seconds for auto recovery.

- Select PAL for Asia Pacific region.
- Select NTSC for Taiwan region.

Getting Started (continued)

Step 5 : Setting the language

The language options are different depending on your country or region. It may not correspond to the illustrations shown on the user manual.

On-screen display (OSD) language

Select this to change the language of this DVD player screen display menu.

The menu language (on-screen display) for the system will remain as you set it.



- 1 Press **SETUP**.
- 2 Press **▲ ▼** to select { **Language** }, then press **▶**.
- 3 Press **▲ ▼** to select { **OSD Language** }, then press **▶**.
- 4 Use **▲ ▼** to select a language and press **OK** to confirm.

Audio, Subtitle and DVD menu languages

You can choose your preferred language or sound track from audio, subtitles and DVD menu languages. If the selected language is not available on the disc, the disc's default language will be used instead.



- 1 Press **SETUP**.
- 2 Press **▲ ▼** to select { **Language** }, then press **▶**.
- 3 Press **▲ ▼** to highlight one of the options below, then press **▶**.
 - { **Audio** }
Select this to change disc sound track language.
 - { **Subtitle** }
Select this to change the subtitle language.
 - { **DVD menu** }
Select this to change the language of the disc menu.
- 4 Use **▲ ▼** to select a language and press **OK** to confirm.
- 5 Repeat steps 3 - 4 for other language settings.

TIPS: The underlined option is the factory default setting.
Press **◀** to go back to previous menu item. Press **SETUP** to exit the menu item.

English

Playback from Disc

IMPORTANT!

- If the **INVALID KEY** appears on the TV screen when a button is pressed, it means the function is not available on the current disc or at the current time.
- **DVD discs and players are designed with regional restrictions. Before playing a disc, make sure the disc is for the same zone as your player.**

Playable discs

Using this DVD player, you can playback on the following discs:

DVD Video (Digital Versatile Disc)



DVD±RW (DVD Rewritable) Audio/Video format or MP3/WMA/JPEG files.



DVD±R (DVD Recordable) Audio/Video format or MP3/WMA/JPEG files.



CD-R (CD-Recordable) Audio/Video format or MP3/WMA/JPEG files.



CD-RW (CD-Rewritable) Audio/Video format or MP3/WMA/JPEG files.



Audio CD (Compact Disc Digital Audio)



Video CD
(Formats 1.0, 1.1, 2.0)



Super Video CD



MP3-Disc



Supported formats

MP3/WMA tracks

- The file extensions has to be to be '.mp3', '.wma'
- JPEG/ISO format
- Maximum 15 characters display.
- Supported sampling frequencies and corresponding bit-rates;

32kHz	64 – 320 kbps
44.1kHz, 48kHz	80 – 320 kbps

JPEG pictures

- The file extensions has to be to be '.JPG' and not '.JPEG.'
- JPEG/ISO format
- It can only display DCF-standard still pictures or JPEG pictures such as TIFF.





Tips:

- *Maximum 100 sessions for CD and 10 multi border for DVD are supported.*
- *For DVD-R and DVD-RW multi border, only finalized disc are supported.*
- *For DVD+R and DVD+RW multi border both finalized and unfinalized disc are NOT supported.*

TIPS: Some discs cannot be played on this DVD player due to the configuration and characteristics of the disc, or due to the condition of recording and authoring software that was used.

Playback Features

Starting disc playback

- 1 Turn on the TV to the correct program number for the DVD player (e.g. 'EXT', '0', 'AV').
- 2 Press **STANDBY-ON**  to turn on the DVD player.
- 3 Press **OPEN/CLOSE**  on the front of the DVD player.
 - You can also hold down the **STOP**  button on the remote control to open and close the disc tray.
- 4 Place a disc into the disc tray with the label facing up, then press **OPEN/CLOSE** .
 - For double-sided discs, load the side which you want to play facing up.
- 5 Playback may start automatically. If not, press **PLAY/PAUSE** .
- If a disc menu appears on the TV, see page 22 'Using the Disc Menu'.
- If the child lock was activated for the inserted disc, you have to enter your four-digit password (see page 36).
- For more playback features, see pages 21~27.



Tips:

- Do not overturn the DVD player while disc loading, playing or ejecting.
- Do not close the disc tray manually even if the power switched off.



Basic playback controls

Unless otherwise stated, all operations described are based on Remote Control use.

Pausing playback

- 1 During playback, press **PLAY/PAUSE**  to pause playback and display a still picture.
 - Sound will be muted.
- 2 To resume normal playback, press **PLAY/PAUSE**  again.

Selecting title/chapter/track

- Press **PREV**  / **NEXT**  to go to the previous or next title/chapter/track.
- Press **DISPLAY** to display the disc information text line for title/chapter/track (example - 00/08).
- Use **alphanumeric keypad (0-9)** to enter valid title/chapter/track number, then press **OK**.
 - The playback skips to the selected title/chapter/track.

Stopping playback

- Press **STOP** .

Tips:

- Screen saver will start automatically if the disc playback is stopped for about 5 minutes.
- The player will automatically switch to Power Standby mode if you do not press any buttons for about 15 minutes after the disc has stopped playing.

TIPS: The operating features described here might not be possible for certain discs. Always refer to the instructions supplied with the discs.

Playback Features (continued)

Operations for video playback

Using the Disc Menu

Depending on the disc, a menu may appear on the TV screen once you load in the disc.

To select a playback feature or item

- Use **▲ ▼ ◀ ▶** keys or **numeric keypad (0-9)** on the remote, then press **OK** to start playback.

To access or remove the menu

- Press **DISC MENU** on the remote.

Zooming in

This function allows you to enlarge the picture on the TV screen and to pan through the enlarged picture.

- 1 During playback, press **ZOOM** repeatedly to display the picture with different scales.
 - Use **▲ ▼ ◀ ▶** keys to pan through the enlarged picture.
 - Playback will continue.
- 2 Press **ZOOM** repeatedly to return to the original size.

Resuming playback from the last stopped point

Resume playback of the last 5 discs is possible, even if the disc was ejected (open) or standby. Auto resume is active for DVD,VCD,SVCD,CD types of discs.

- Load one of the last 5 discs.
 - 'Play from start, press [PREV]' appears during playback for first 10 seconds.

- During the message appears on the TV screen, press **PREV** to start playback from the beginning.
 - Playback restarts from the first title (DVD) or the beginning of the title/track (VCD/CDDA/SVCD).
- To remove the message from the TV screen, press **DISPLAY**.

Slow Motion

You can slow forward or slow reverse a disc during playback and select a different speed.

For DVD,VCD,SVCD

- 1 Press **▲ ▼** during playback to select the required speed: 1/2, 1/4, 1/8 or 1/16 (forward or backward).
 - Sound will be muted.
- 2 To return to normal speed, press **PLAY/PAUSE ▶II**.

Forward / Reverse Searching

You can fast forward or fast reverse a disc during playback and select a desired search speed.

For DVD,VCD,SVCD,CD

- 1 Press **◀ ▶** directly or press **◀ ▶** for 2 seconds during playback to select the required speed: 2X, 4X, 8X, 16X or 32X (backward or forward).
 - Sound will be muted (DVD/VCD) or intermittent (CD).
- 2 To return to normal speed, press **PLAY/PAUSE ▶II**.

Tip:

– For CD, fast forward or fast reverse is available only when pressing **◀ ▶** for few seconds or more.

TIPS: The operating features described here might not be possible for certain discs. Always refer to the instructions supplied with the discs.

Playback Features (continued)

Viewing the disc playback information

You can view the disc information (such as current title/chapter/track number, total elapsed time and total playing time on the disc) without interrupting the disc playback.

- During playback, press **DISPLAY** repeatedly on the remote control.
→ The available disc information appears on the TV screen with the following sequence.

Title/Chapter

Title 1/1 Chapter 6/16 (DVD)

Time

Time 00:03:36/01:22:34 (DVD)

Repeat/ Repeat A-B/ Angle

Off Rep Off 1/1 (DVD)

Track

Track 3/21 (VCD)

Time

Time 00:00:56/00:03:34 (VCD)

Repeat/ Repeat A-B

Off Rep Off (VCD)

Title/Chapter/Track selection

- 1 Press ◀▶ to select {Title} / {Chapter} or {Track}, then press **OK** to access.
- 2 Use the **alphanumeric keypad 0-9** to input a valid number.
- 3 Press **OK** to confirm.
→ The playback skips to the chosen title/ chapter/track.

Time Search

- 1 When {Time} information appears on the TV screen, press **OK** to access.
- 2 Use the **alphanumeric keypad 0-9** to input the valid time (such as 0:34:27).
- 3 Press **OK** to confirm.
→ The playback skips to the chosen time.

Angle

- 1 When {Angle} information appears on the TV screen, press ◀▶ to highlight {Angle}.
- 2 Press **OK** repeatedly to switch between different angle.
→ Playback will go to the selected angle.

TIPS: The operating features described here might not be possible for certain discs. Always refer to the instructions supplied with the discs.

Playback Features (continued)

Repeat play mode

The repeat play options vary depending on the disc type.

- ① When 'Repeat' information appears on the TV screen, press ◀▶ to highlight {Off}, then press **OK** to access.
→ Repeat menu appears on the TV.
- ② Press **OK** repeatedly to select the following repeat modes.

For DVD

- Repeat Chapter (currently playing chapter)
- Repeat Title (currently playing title)
- Off (cancel)

For Video CD, Audio CD

- Repeat Single (currently playing track)
- Repeat All (entire disc)
- Off (cancel)

For MP3/WMA

- Repeat Single (currently playing track)
- Repeat Folder (current folder)
- Off (cancel)

For JPEG

- Repeat Single (currently playing file)
- Repeat Folder (current folder)
- Off (cancel)

Tip:

- For VCD/SVCD, repeat playback is not possible if the PBC mode is switched on.

Repeating a section within a chapter/track

You can repeat the playback of a specific segment within a title/chapter track. To do this, you must mark the start and end of the segment you want.

- ① When 'Repeat' information appears on the TV screen, press ◀▶ to highlight {Rep Off}.
- ② Press **OK** to choose your starting point 'A'.
- ③ Press **OK** again at your chosen end point 'B'.
→ The section from point 'A' to 'B' will now repeat continuously.
- ④ Press **OK** the third time to exit.

TIPS: The operating features described here might not be possible for certain discs. Always refer to the instructions supplied with the discs.

Playback Features (continued)

Special DVD Features

Playing a Title

- 1 Press **DISC MENU**.
→ The disc title menu appears on the TV screen.
- 2 Use **▲ ▼ ◀ ▶** keys or **alphanumeric keypad 0-9** to select a play option.
- 3 Press **OK** key to confirm.

Changing the Audio Language

For DVD

- Press **AUDIO** repeatedly to select different audio languages.

Changing the Audio Channel For VCD

- Press **AUDIO** to select the available audio channels provided by the disc (LEFT, RIGHT, MIX, STEREO).

Subtitles

- Press **SUBTITLE** repeatedly to select different subtitle languages.

Special VCD and SVCD Feature

Playback Control (PBC)

For VCD with Playback Control (PBC) feature (version 2.0 only)

- Press **DISC MENU** to toggle between 'PBC ON' and 'PBC OFF'.
→ If you select 'PBC ON', the disc menu (if available) will appear on the TV.
→ Use the **PREV ◀** / **NEXT ▶** to turn to previous/page page or use the **alphanumeric keypad 0-9** to select a play option.
 - During playback,
→ pressing **PREV ◀** after the first 5 seconds, playback will start from the beginning of the current track,
→ pressing **PREV ◀** within the first 5 seconds, playback will go to the previous track.
 - During playback, pressing **RETURN/TITLE** will return to the menu screen (if PBC is on).
- If you want to skip the index menu and playback directly from the beginning,**
- Press **DISC MENU** key on the remote control to turn to PBC off.

TIPS: The operating features described here might not be possible for certain discs. Always refer to the instructions supplied with the discs.

Playback Features (continued)

Playing MP3/WMA/JPEG/ Kodak/Fuji Picture CD

IMPORTANT!

You have to turn on your TV and set to the correct Video In channel. (See page 16 'Finding your viewing channel').

General Operation

- 1 Load a disc.
 - The disc reading time may exceed 30 seconds due to the complexity of the directory/file configuration.
 - The data disc menu and ID3 (MP3) / Meta data (WMA) information (including at least title, singer and album) appears on the TV screen.



- 2 Press ▲ ▼ to select the folder and press **OK** to open the folder.
- 3 Press ▲ ▼ to select a track/file.
- 4 Press **OK** to confirm.

Tips:

- If the playing file is not selected, the ID3/ Meta information will disappear.
- If a jpeg file is selected, a preview will appear.

Playback selection

During playback, you can;

- Press **PREV** ◀ / **NEXT** ▶ to select the previous/next track/file in the current folder.
- Press ▲ ▼ ◀ ▶ on the remote to rotate/flip the picture files.
- Press **PLAY/PAUSE** ▶|| repeatedly to pause/resume playback.

For MP3/WMA,

- During playback,
 - pressing **PREV** ◀ after the first 5 seconds, playback will start from the beginning of the current track,
 - pressing **PREV** ◀ within the first 5 seconds, playback will go to the previous track.
- During playback, press and hold **PREV** ◀ / **NEXT** ▶ for about few seconds to access fast forward or fast reverse with the required speed: 2X, 4X, 8X, 16X or 32X.

Tip:

- For MP3/WMA, fast forward or fast reverse is available only when pressing ◀ ▶ for few seconds or more.

TIPS: The operating features described here might not be possible for certain discs. Always refer to the instructions supplied with the discs.

Playback Features (continued)

Zoom picture (JPEG)

- During playback, press **ZOOM** repeatedly to display the picture with different scales.
- Use ▲ ▼ ◀ ▶ to view the zoomed picture.

Playback with multi-angles (JPEG)

- During playback, press ▲ ▼ ◀ ▶ to rotate the picture on the TV screen.
 - ▲ ▼: flip the picture vertically by 180°
 - ◀: rotate the picture anti-clockwise by 90°
 - ▶: rotate the picture clockwise by 90°

Tip:

– It may not be possible to play certain MP3/JPEG disc due to the configuration and characteristics of the disc or condition of the recording.

TIPS: The operating features described here might not be possible for certain discs. Always refer to the instructions supplied with the discs.

Karaoke Operations

Playing Karaoke discs

IMPORTANT!

You have to turn on your TV and set to the correct Video In channel. (See page 16 'Finding your viewing channel').

General Operation

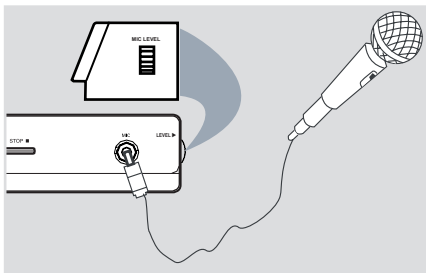

- 1 Connect a microphone (not supplied) to **MIC** on the front panel of the DVD player.
- 2 Press **KARAOKE** repeatedly to access Karaoke menu.
 - 'Karaoke : Off' appears on the TV screen.
 - Press **OK** to turn 'On' or 'Off' the karaoke mode.
- 3 Load a karaoke disc and press **PLAY/PAUSE ►||**.
- 4 Adjust the microphone volume up or down using **MIC LEVEL** button on the side of the panel of the DVD player.

Tip:

– Before connecting the microphone, set the microphone volume to the minimum level to prevent howling.

Vocal

- You can fade out the original vocal from a karaoke disc.
- Press **VOCAL** repeatedly to choose different audio modes.

Tip:

– This function and on-screen display depends on the availability of the disc.

Karaoke

- Press **KARAOKE** repeatedly to access the karaoke menu.
- Press **▲ ▼** to select 'Karaoke', 'Key Shift', 'Echo', 'Voice Cancel'.
 - 1 When 'Karaoke' is selected, press **OK** to set karaoke 'On' or 'Off'.
 - 2 When 'Key Shift' is selected, press **◀ ▶** to adjust the pitch value between 0 and 14.

This function allows you to adjust the key tone level to match your vocal.
 - 3 When 'Echo' is selected, press **◀ ▶** to adjust the echo level.
 - 4 When 'Voice Cancel' is selected, press **OK** to set voice cancel 'On' or 'Off'.

DVD Menu Options

This DVD Player setup is carried out via the TV, enabling you to customize the DVD player to suit your particular requirement.

Using the Language setup menu

- 1 Press **SETUP** on the remote control.
→ The system setup menu appears.



- 2 Press **▲ ▼** to select { **Language** }, then press **▶**.
- 3 Press **▲ ▼** to select an item, then press **▶** to access.
Example: { **OSD Language** }
→ The options for the selected item appears.
→ If the selection in the menu is greyed out, that means the feature is not available or not possible to change at the current state.
- 4 Use **▲ ▼** to select a setting and press **OK** to confirm.
Example: { **English** }
→ The setting is selected and setup is complete.
- 5 To exit, press **SETUP**.

OSD Language

This menu contains various language options for the language displayed on the screen. For details, see page 19.

Subtitle/Audio/DVD Menu

These menus contain various language options for audio, subtitle and disc menu which may be recorded on the DVD. For details, see page 19.

English

TIPS: The underlined option is the factory default setting.
Press **◀** to go back to previous menu item. Press **SETUP** to exit the menu item.

DVD Menu Options (continued)

Using the Video setup menu

- 1 Press **SETUP** on the remote control.
→ The system setup menu appears.

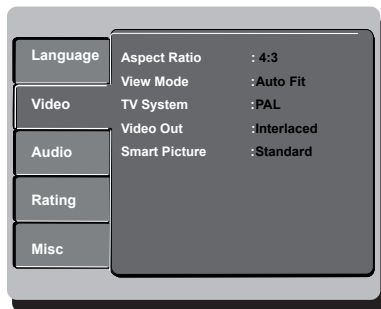

- 2 Press **▲ ▼** to select { **Video** }, then press **▶**.
- 3 Press **▲ ▼** to select an item, then press **▶** to access.
Example: { **TV System** }
→ The options for the selected item appears.
→ If the selection in the menu is greyed out, that means the feature is not available or not possible to change at the current state.
- 4 Use **▲ ▼** to select a setting and press **OK** to confirm.
Example: { **PAL** }
→ The setting is selected and setup is complete.
- 5 To exit, press **SETUP**.

Setting the Aspect Ratio

The picture shape can be adjusted to fit your TV and the format must be available on the playback disc. Otherwise, the TV display will not affect the picture during playback.

- 1 In 'Video', press **▲ ▼** to select { **Aspect Ratio** }, then press **▶**.

{ **4:3** }

Select this if you have a normal TV. A 'wide-screen' display with black bars on the top and bottom will be displayed on the TV screen.



{ **16:9** }

Select this for wide-screen TV (frame ratio 16:9).

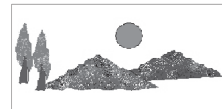

- 2 Use **▲ ▼** to select a setting and press **OK** to confirm.

TIPS: The underlined option is the factory default setting.
Press **◀** to go back to previous menu item. Press **SETUP** to exit the menu item.

DVD Menu Options (continued)

View Mode

Use view mode to scale an image that fits to the TV screens' width and height.

- 1 In 'Video', press ▲ ▼ to select { **View Mode** }, then press ►.

{ **Fill** }

Select this to scale the image up or down in horizontal and vertical directions respectively to fill the screen height and width.

{ **Original** }

Select this to fit the original screen size (only for MPEG).

{ **Height Fit** }

Select this to scale the image up or down in vertical direction to fit the screen height.

{ **Width Fit** }

Select this to scale the image up or down in horizontal direction to fit the screen width.

{ **Auto Fit** }

Select this to take the minimum value of horizontal and vertical fit scale ratio (like letter box).

{ **Pan Scan** }

Select this to take the maximum value of horizontal and vertical fit scale ratio.

- 2 Use ▲ ▼ to select a setting and press **OK** to confirm.

TV System

This menu contains the options for selecting the color system that matches the connected TV. For details, see page 18.

Video Out

This setting allows you to toggle the output of the video signal between Interlaced and P-Scan (Progressive Scan).

- 1 In 'Video', press ▲ ▼ to select { **Video Out** }, then press ►.

{ **Interlaced** }

Select this for Interlaced (YPbPr) connection.

{ **P-Scan** }

Select this when you want to make progressive scan (YPbPr) connection on your DVD player to a progressive scan TV.

- 2 Use ▲ ▼ to select a setting and press **OK** to confirm.

TIPS: The underlined option is the factory default setting.
Press ◀ to go back to previous menu item. Press **SETUP** to exit the menu item.

DVD Menu Options (continued)

Smart Picture

This DVD player provides four predefined sets of picture color settings.

- In 'Video', press ▲ ▼ to select { **Smart Picture** }, then press ►.

{ Standard }

Select this for a preset standard picture setting.

{ **Vivid** }

Select this to make the picture brighter.

{ **Cool** }

Select this to make the picture softer.

{ **Personal** }

Select this to personalize your picture color by adjusting the brightness, contrast, tint and color (saturation).

- Use ▲ ▼ to select a setting and press **OK** to confirm.
- If you select {PERSONAL}, then proceed to steps 4~7.
→ The setup menu appears.



- Press ▲ ▼ to highlight one of the following options.

BRIGHTNESS

Increase the value to brighten the picture or vice versa. Choose zero (0) for average setting.

CONTRAST

Increase the value to sharpen the picture or vice versa. Choose zero (0) to balance the contrast.

TINT

Increase the value to darken the picture or vice versa. Choose zero (0) for average setting.

COLOR

Increase the value to enhance the color in your picture or vice versa. Choose zero (0) to balance the color.

- Press ◀ ▶ to adjust the setting that best suits your personal preference.
- Repeat steps 4~5 for adjusting other color features.
- Press **OK** to confirm.

TIPS: The underlined option is the factory default setting.
Press ◀ to go back to previous menu item. Press **SETUP** to exit the menu item.

DVD Menu Options (continued)

Using the Audio setup menu

- 1 Press **SETUP** on the remote control.
→ The system setup menu appears.

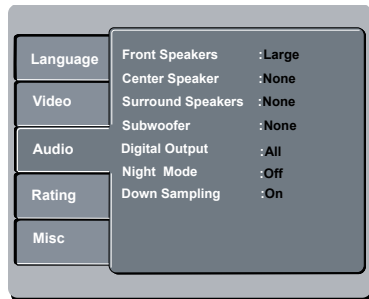

- 2 Press **▲ ▼** to select { **Audio** }, then press **▶**.
- 3 Press **▲ ▼** to select an item, then press **▶** to access.
Example: { **Night Mode** }
→ The options for the selected item appears.
→ If the selection in the menu is greyed out, that means the feature is not available or not possible to change at the current state.
- 4 Use **▲ ▼** to select a setting and press **OK** to confirm.
Example: { **On** }
→ The setting is selected and setup is complete.
- 5 To exit, press **SETUP**.

Front / Center / Surround Speakers

You can adjust the volume level setting for individual speakers.

- 1 In 'Audio', press **▲ ▼** to select { **Front Speakers** }, { **Center Speaker** } or { **Surround Speakers** }, then press **▶**.

{ **Large** }

When connected speakers (except for subwoofer) can produce low frequency signals below 120Hz.

→ The range from 20Hz to 20KHz

{ **Small** }

When connected speakers (except for subwoofer) can not produce low frequency signals below 120Hz.

→ The range from 120Hz to 20KHz

{ **None** }

No sound output from the speakers.
Only applicable for center and rear speakers.

- 2 Use **▲ ▼** to select a setting and press **OK** to confirm.

Subwoofer

This option is only available for subwoofer connection.

- 1 In 'Audio', press **▲ ▼** to select { **Subwoofer** }, then press **▶**.

{ **Present** }

Select this option when a subwoofer is connected.

{ **None** }

Select this option when no subwoofer is connected.

- 2 Use **▲ ▼** to select a setting and press **OK** to confirm.

TIPS: The underlined option is the factory default setting.
Press **◀** to go back to previous menu item. Press **SETUP** to exit the menu item.

DVD Menu Options (continued)

Digital Output

Select this if you connect to a multichannel decoder/receiver.

- In 'Audio', press ▲ ▼ to select { **Digital Output** }, then press ►.

{ All }

Select this if the connected device has a built-in multichannel decoder that supports one of the multichannel audio format (Dolby Digital, MPEG-2).

{ PCM }

Select this if the connected device is not capable of decoding multichannel audio. The DVD player will convert the Dolby Digital and MPEG-2 multichannel signals to PCM (Pulse Code Modulation).

{ Off }

To deactivate the digital audio output. For example, if you use the FRONT (L/R) AUDIO OUT sockets to connect to a TV or stereo system.

- Use ▲ ▼ to select a setting and press **OK** to confirm.

Tips:

- If { Digital Output } is set to { All }, all audio settings except MUTE are invalid.
- If { Digital Output } is set to { All } while playback MPEG, MP3/WMA files, the player will output PCM signals.

Night Mode

This mode optimizes playback of sound at low volume. High volume outputs will be softened and low volume outputs are brought upward to an audible level.

- In 'Audio', press ▲ ▼ to select { **Night Mode** }, then press ►.

{ On }

Select this to set low volume output. This feature is only available for movie discs with Dolby Digital mode.

{ Off }

Turns off night mode feature. Select this to enjoy the surround sound with its full dynamic range.

- Use ▲ ▼ to select a setting and press **OK** to confirm.

Down Sampling

You can enable and disable the digital signal for better sound output quality.

- In 'Audio', press ▲ ▼ to select { **Down Sampling** }, then press ►.

{ On }

Playback a disc recorded at the sampling rate of 48kHz.

{ Off }

Playback a disc recorded at the sampling rate of 96kHz. This rate can only be achieved in Stereo-Classic (Flat) mode.

- Use ▲ ▼ to select a setting and press **OK** to confirm.

TIPS: The underlined option is the factory default setting.
Press ◀ to go back to previous menu item. Press **SETUP** to exit the menu item.

DVD Menu Options (continued)

Using the Rating setup menu

- 1 Press **SETUP** on the remote control.
→ The system setup menu appears.

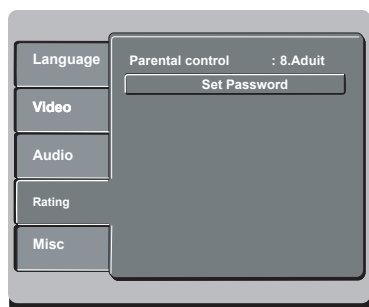

- 2 Press **▲ ▼** to select { **Rating** }, then press **▶**.
- 3 Press **▲ ▼** to select an item, then press **▶** to access.
Example: { **Parental control** }
→ The options for the selected item appears.
→ If the selection in the menu is greyed out, that means the feature is not available or not possible to change at the current state.
- 4 Use **▲ ▼** to select a setting and press **OK** to confirm.
Example: { **8 Adult** }
→ The setting is selected and setup is complete.
- 5 To exit, press **SETUP**.

Rating level settings

Depending on the DVD, you may be asked to change the parental level while playing the disc. The rating levels are from 1 to 8 and are country dependent. You can prohibit the playing of certain discs that are not suitable for your children, or have certain discs played with alternative scenes.

- 1 In 'Rating', press **▲ ▼** to select { **Parental control** }, then press **▶**.
- 2 Use the **alphanumeric keypad 0-9** to enter the four-digit password (see page 36 'Changing the Password', then press **▶**.

{ **1. Kid Safe** }

Childsafe; acceptable for viewers of all ages.

{ **2. G** }

General Audience; recommended as acceptable for viewers of all ages.

{ **3. PG** }

Parental Guidance suggested.

{ **4. PG – 13** }

Unsuitable for children under age 13.

{ **5. PG – R** }

Parental Guidance; recommended that parents restrict children under 17 from viewing.

{ **6. R** }

Restricted; recommended only when supervised by a parent or adult guardian.

{ **7. NC – 17** }

No Children under age 17; not recommended viewing for children under age 17.

{ **8. Adult** }

Mature Material; should be viewed only by adults due to graphic sexual material, violence or language.

TIPS: The underlined option is the factory default setting.
Press **◀** to go back to previous menu item. Press **SETUP** to exit the menu item.

DVD Menu Options (continued)

- ③ Use ▲ ▼ to select a rating level and press **OK** to confirm.
 - Select { **8 Adult** } to disable parental level and allow all discs to play.
- DVDs that are rated higher than the level you selected will not play unless you enter your four-digit password.

Tips:

- This feature will not limit viewing if the disc manufacturer did not code the disc.
- VCD, SVCD, CD have no level indication, so parental control has no effect on these type of discs. This also applies to most illegal DVDs.
- Some DVDs are not coded with a rating though the movie rating may be printed on the disc cover. The rating level feature does not prohibit play of such discs.

Changing the Password

You need to enter your four-digit password to play a prohibited disc or if prompted for a password.

- ① In 'Rating', press ▲ ▼ to select { **Set Password** }, then press **OK**.
 - You will be prompted to enter your four-digit password.

Enter Password

- ② Use the **alphanumeric keypad 0-9** to enter the four-digit password.
 - When doing this for the first time, enter the default password '0000'.
- If you forget your old four-digit password, enter the default password '0000'.
- ③ Press **OK** again to enter the new four-digit password.
 - The new four-digit password will now take effect.

Enter New Password

- ④ Press **OK** to confirm.

TIPS: The underlined option is the factory default setting.
Press ◀ to go back to previous menu item. Press **SETUP** to exit the menu item.

DVD Menu Options (continued)

English

Using the Misc (Miscellaneous) setup menu

- 1 Press **SETUP** on the remote control.
→ The system setup menu appears.

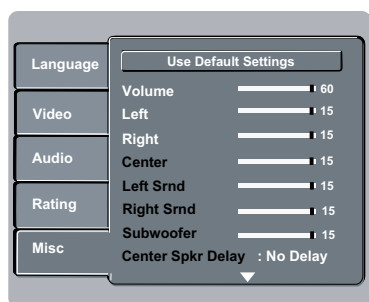

- 2 Press **▲ ▼** to select { **Misc** }, then press **▶**.
- 3 Press **▲ ▼** to select an item, then press **OK** to access.
Example: { **Use Default Settings** }
→ The options for the selected item appears.
→ If the selection in the menu is greyed out, that means the feature is not available or not possible to change at the current state.
- 4 Use **▲ ▼** to select a setting and press **OK** to confirm.
Example: { **No** }
→ The setting is selected and setup is complete.
- 5 To exit, press **SETUP**.

Restoring to the original settings

Setting the { Default } function will reset all options and your personal settings to the factory defaults, except your password for rating level.

- 1 In 'Misc', press **▲ ▼** to select { **Use Default Settings** }, then press **OK**.
→ The menu will appear.

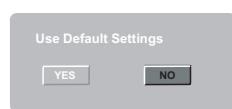

{ **Yes** }
Select this to reset to factory default settings.

{ **No** }
Select this to close the menu.

- 2 Use **◀ ▶** to select a setting and press **OK** to confirm.

TIPS: The underlined option is the factory default setting.
Press **◀** to go back to previous menu item. Press **SETUP** to exit the menu item.

DVD Menu Options (continued)

Volume Control

- 1 In 'Misc', press ▲ ▼ to select { **Volume** }.
- 2 Press ◀ ▶ to adjust the speaker's volume that best suits your personal preference.
→ The range from { **0 – 63** }
- 3 Press ▲ ▼, then press ◀ ▶ to adjust the volume corresponding speakers from 0-15.

Speaker Delay

Delay times setting are related to the listening position or distance for center and surround speakers.

- 1 In 'Misc', press ▲ ▼ to select { **Center Sprk Delay** } or { **Surr Sprk Delay** }, then press **OK**.
- 2 Use ▲ ▼ to move the slider to adjust the delay times of the audio output from the corresponding speakers.

TIPS: The underlined option is the factory default setting.
Press ◀ to go back to previous menu item. Press **SETUP** to exit the menu item.

Software upgrade

Periodically Philips will issue software upgrade to enhance your user experience.

IMPORTANT!

– **Power supply must not be interrupted during upgrade!**

To check the current software version of this DVD player;

- ① Press **OPEN/CLOSE ▲** on the DVD player to open the disc tray.
→ The disc tray will open.
- ② Press **numeric keypad '966'** on the remote control.
→ The software installed in the DVD player appears on the TV screen.

To download and install the latest software to the DVD player;

- ① Visit the Philips website 'www.philips.com/support' to check the availability of the latest software upgrade.
- ② Download the software to a CD-R.
- ③ Insert the CD-R to the disc slot.
→ The menu appears.

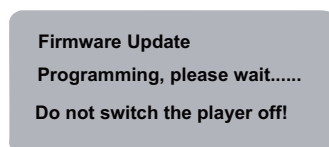
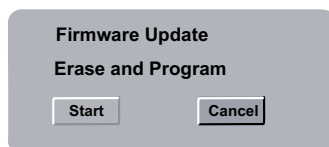

- ④ Press **◀▶** to select { **START** }, then press **OK** to confirm.
→ The latest software will be downloaded in the DVD player.

Troubleshooting

WARNING

Under no circumstances should you try to repair the system yourself, as this will invalidate the warranty. Do not open the system as there is a risk of electric shock.

If a fault occurs, first check the points listed below before taking the system for repair. If you are unable to remedy a problem by following these hints, consult your dealer or Philips for help.

Problem	Solution
No power.	<ul style="list-style-type: none"> – Press STANDBY-ON button on the front of the DVD player to turn on the system. – Make sure the AC outlet has power.
Remote control does not work.	<ul style="list-style-type: none"> – Aim the remote control directly at the sensor on the front of the DVD player (not towards TV). – Remove any obstacles between DVD player and the remote control. – Batteries are weak, replace the batteries. – Check the polarities of the batteries are as indicated on the remote control (± signs).
No picture.	<ul style="list-style-type: none"> – Turn on your TV and set to the correct Video In channel for the DVD player. You may go to Channel 1 on your TV, then press the channel down button on your TV's remote control until you see the TV program. – Check the video connection between the DVD player and the TV.
The picture is distorted or black & white during playback.	<ul style="list-style-type: none"> – The disc does not match with the TV color system standard (PAL/NTSC). – The disc is dirty, clean the disc. – Sometimes a small amount of picture distortion may appear. This is not a malfunction. – To deactivate progressive scan function manually; <ol style="list-style-type: none"> 1) Turn off your TV progressive scan mode (or set to interlaced mode) 2) Press OPEN/CLOSE to open the DVD player disc tray. 3) Press the alphanumeric keypad '1' for few seconds.
No sound.	<ul style="list-style-type: none"> – Check the audio connections, the red and white jacks are connected correctly. – Set the Digital output correctly, based on the equipment you connected to the DVD player.
Disc does not play.	<ul style="list-style-type: none"> – Insert the disc with the label facing up. – Wrong region code. – Wrong disc type. Read chapter "Playback from Disc - Playable discs" for details. – Make sure the disc is not scratched or warped. Clean the disc or replace a new one. – Check if the disc is defective by trying another disc.
The aspect ratio of the screen cannot be changed.	<ul style="list-style-type: none"> – The aspect ratio is fixed on the DVD disc. – Depending on the TV, it may not be possible to change the aspect ratio.

Need Help? Visit us at www.philips.com/support

Troubleshooting (continued)

Problem	Solution
Not able to select some items in the setup/system menu.	<ul style="list-style-type: none">– Press STOP button twice before selecting the setup/system menu.– Depending on the disc availability, some menu items cannot be selected.
The DVD player does not start playback.	<ul style="list-style-type: none">– Insert a readable disc with the playback side facing down.– Check the disc type, color system (PAL/NTSC) and region code.– Check for any scratches or smudges on the disc.– Press SETUP to turn off the setup menu screen.– You may need to enter the password in order to change the parental rating level or to unlock the disc for playback.– Moisture may have condensed inside the system. Remove the disc and leave the system turned on for about an hour.– Disconnect the power cord from the power outlet for a few minutes. Reconnect the power cord and try to operate again as usual.
Picture freezes momentarily during playback.	<ul style="list-style-type: none">– Check the disc for fingerprint/scratches and clean with a soft cloth wiping from center to edge.
Unable to select Progressive Scan on/off.	<ul style="list-style-type: none">– Check that the output of the video signal is turn to { Interlaced }.

English

Need Help? Visit us at www.philips.com/support

Specifications

TV STANDARD(PAL/50Hz)(NTSC/60Hz)

Number of lines	625	525
Playback	Multistandard(PAL/NTSC)	

VIDEO PERFORMANCE

Video DAC	12 bit, 108 MHz	
YPbPr	0.7 Vpp ~ 75 ohm	
Video Output	1Vpp ~ 75 ohm	

VIDEO FORMAT

Digital	MPEG 2 for DVD,SVCD	
Compression	MPEG 1 for VCD	

DVD	50Hz	60Hz
Horiz. resolution	720 pixels	720 pixels
Vertical resolution	576 lines	480 lines

VCD	50Hz	60Hz
Horiz. resolution	352 pixels	352 pixels
Vertical resolution	288 lines	240 lines

AUDIO FORMAT

Digital	MPEG/ AC-3/ PCM	compressed Digital 16, 20, 24 bits fs, 44.1, 48, 96 kHz
	MP3(ISO 9660)	96, 112, 128, 256. 320kbps & variable bit rate fs, 32, 44.1, 48 kHz

Analog Sound Stereo
Dolby Surround compatible downmix from Dolby
Digital multi-channel sound

AUDIO PERFORMANCE

DA Converter	24 bit, 192 kHz	
DVD	fs 96 kHz	4Hz- 44kHz
	fs 48 kHz	4Hz- 22kHz
SVCD	fs 48 kHz	4Hz- 22kHz
	fs 44.1kHz	4Hz- 20kHz
CD/VCD	fs 44.1kHz	4Hz- 20kHz
Signal-Noise (1kHz)	> 90 dB	
Dynamic range(1kHz)	> 80 dB	
Crosstalk (1kHz)	> 70 dB	
Distortion/noise (1kHz)	> 65 dB	
MPEG MP3	MPEG Audio L3	

CONNECTIONS

YPbPr Output	Cinch 3x
Video Output	Cinch (yellow)
Audio Output(L+R)	Cinch (white/red)
Digital Output	1 coaxial IEC60958 for CDDA / LPCM IEC61937 for MPEG 1/2, Dolby Digital

6 channel analog output

Audio Front L/R	Clinch (white/red)
Audio Rear L/R	Clinch (white/red)
Audio Center	Clinch (blue)
Audio Subwoofer	Clinch (black)

CABINET

Dimensions (w x h x d)	360 x 37 x 209 mm
Weight	Approximately 1.35 kg

POWER CONSUMPTION

Power Supply Rating	110V – 240V; 50/60Hz
Power consumption	< 10 W
Power consumption in Standby mode	< 1 W

Glossary

Analog: Sound that has not been turned into numbers. Analog sound varies, while digital sound has specific numerical values. These jacks send audio through two channels, the left and right.

Aspect ratio: The ratio of vertical and horizontal sizes of a displayed image. The horizontal vs. vertical ratio of conventional TVs. is 4:3, and that of wide-screens is 16:9.

AUDIO OUT Jacks: Jacks on the back of the DVD System that send audio to another system (TV, Stereo, etc.).

Bit Rate: The amount of data used to hold a given length of music; measured in kilobits per seconds, or kbps. Or, the speed at which you record. Generally, the higher the bit rate, or the higher the recording speed, the better the sound quality. However, higher bit rates use more space on a Disc.

Chapter: Sections of a picture or a music piece on a DVD that are smaller than titles. A title is composed of several chapters. Each chapter is assigned a chapter number enabling you to locate the chapter you want.

Component Video Out Jacks: Jacks on the back of the DVD System that send high-quality video to a TV that has Component Video In jacks (R/G/B, Y/Pb/Pr, etc.).

Disc menu: A screen display prepared for allowing selection of images, sounds, subtitles, multi-angles, etc recorded on a DVD.

Digital: Sound that has been converted into numerical values. Digital sound is available when you use the DIGITAL AUDIO OUT COAXIAL or OPTICAL jacks. These jacks send audio through multiple channels, instead of just two channels as analog does.

Dolby Digital: A surround sound system developed by Dolby Laboratories containing up to six channels of digital audio (front left and right, surround left and right, center and subwoofer).

JPEG: A very common digital still picture format. A still-picture data compression system proposed by the Joint Photographic Expert Group, which features small decrease in image quality in spite of its high compression ratio.

MP3: A file format with a sound data compression system. 'MP3' is the abbreviation of Motion Picture Experts Group 1 (or MPEG-1) Audio Layer 3. By using MP3 format, one CD-R or CD-RW can contain about 10 times as much data volume as a regular CD can.

Parental Control: A function of the DVD to limit playback of the disc by the age of the users according to the limitation level in each country. The limitation varies from disc to disc; when it is activated, playback will be prohibited if the software's level is higher than the user-set level.

PCM (Pulse Code Modulation): A system for converting analog sound signal to digital signal for later processing, with no data compression used in conversion.

Playback control (PBC): Refers to the signal recorded on video CDs or SVCDs for controlling reproduction. By using menu screens recorded on a Video CD or SVCD that supports PBC, you can enjoy interactive-type software as well as software having a search function.

Progressive Scan: It displays all the horizontal lines of a picture at one time, as a signal frame. This system can convert the interlaced video from DVD into progressive format for connection to a progressive display. It dramatically increases the vertical resolution.

Region code: A system for allowing discs to be played back only in the region designated beforehand. This unit will only play discs that have compatible region codes. You can find the region code of your unit by looking on the product label. Some discs are compatible with more than one region (or ALL regions).

Title: The longest section of a picture or music feature on DVD, music, etc., in video software, or the entire album in audio software. Each title is assigned a title number enabling you to locate the title you want.

TV OUT jack: Jack on the back of the DVD System that sends video to a TV.

WMA: Windows Media Audio. Refers to an audio compression technology developed by Microsoft Corporation. WMA data can be encoded by using Windows Media Player version 9 or Windows Media Player for Windows XP. Files are recognized by their file extension "WMA."