

Always there to help you

Register your product and get support at
www.philips.com/support



HTL4111B



User manual

PHILIPS

Contents

1	Important	2
	Safety	2
	Mains fuse (UK only)	3
	Care for your product	3
	Care of the environment	3
	Help and support	3
	Compliance	4

2	Your SoundStage	4
	Main unit	4
	Remote control	5
	Connectors	6

3	Place your SoundStage	6
----------	------------------------------	---

4	Connect and set up	7
	Connect to TV	7
	Connect audio from TV and other devices	8

5	Use your SoundStage	9
	Adjust the volume	9
	Choose your sound	9
	MP3 player	9
	Play audio through Bluetooth	9
	Play music via NFC	10
	USB storage devices	10
	Auto standby	11
	Apply factory settings	11

6	Update software	11
	Check software version	11
	Update software via USB	11

7	Product specifications	12
----------	-------------------------------	----

8	Troubleshooting	13
----------	------------------------	----

1 Important

Read and understand all instructions before you use your product. If damage is caused by failure to follow instructions, the warranty does not apply.

Read and understand all instructions before you use your SoundStage. If damage is caused by failure to follow instructions, the warranty does not apply.

Safety

Risk of electric shock or fire!

- Never expose the product and accessories to rain or water. Never place liquid containers, such as vases, near the product. If liquids are spilt on or into the product, disconnect it from the power outlet immediately. Contact Consumer Care to have the product checked before use.
- Never place the product and accessories near naked flames or other heat sources, including direct sunlight.
- Never insert objects into the ventilation slots or other openings on the product.
- Where the mains plug or an appliance coupler is used as the disconnect device, the disconnect device shall remain readily operable.
- Disconnect the product from the power outlet before lightning storms.
- When you disconnect the power cord, always pull the plug, never the cable.

Risk of short circuit or fire!

- Before you connect the product to the power outlet, ensure that the power voltage matches the value printed on the back or bottom of the product. Never connect the product to the power outlet if the voltage is different.

Risk of injury or damage to this product!

- Never place the product or any objects on power cords or on other electrical equipment.
- If the product is transported in temperatures below 5°C, unpack the product and wait until its temperature matches room temperature before connecting it to the power outlet.
- Parts of this product can be made of glass. Handle with care to avoid injury and damage.

Risk of overheating!

- Never install this product in a confined space. Always leave a space of at least four inches around the product for ventilation. Ensure curtains or other objects never cover the ventilation slots on the product.

Risk of contamination!

- Do not mix batteries (old and new or carbon and alkaine, etc.).
- Danger of explosion if batteries are incorrectly replaced. Replace only with the same or equivalent type.
- Remove batteries if they are exhausted or if the remote control is not to be used for a long time.
- Batteries contain chemical substances, they should be disposed of properly.

Risk of swallowing batteries!

- The product/remote control may contain a coin/button type battery, which can be swallowed. Keep the battery out of reach of children at all times! If swallowed, the battery can cause serious injury or death. Severe internal burns can occur within two hours of ingestion.
- If you suspect that a battery has been swallowed or placed inside any part of the body, seek immediate medical attention.
- When you change the batteries, always keep all new and used batteries out of reach of children. Ensure that the battery compartment is completely secure after you replace the battery.

- If the battery compartment cannot be completely secured, discontinue use of the product. Keep out of reach of children and contact the manufacturer.



This is CLASS II apparatus with double insulation, and no protective earth provided.

Mains fuse (UK only)

This information applies only to products with a UK mains plug.

This product is fitted with an approved molded plug. If you replace the fuse, use one with:

- the ratings shown on the plug,
- a BS 1362 approval, and
- the ASTA approval mark.

Contact your dealer if you are not sure about what type of fuse to use.

Caution: To conform with the EMC directive (2004/108/EC), do not detach the plug from the power cord.

Copyright in the UK

Recording and playback of material may require consent. See Copyright Act 1956 and The Performers Protection Acts 1958 to 1972.

Care for your product

Use only microfiber cloth to clean the product.

Care of the environment



Your product is designed and manufactured with high quality materials and components, which can be recycled and reused.



When this crossed-out wheeled bin symbol is attached to a product it means that the product is covered by the European Directive 2002/96/EC. Please inform yourself about the local separate collection system for electrical and electronic products.

Please act according to your local rules and do not dispose of your old products with your normal household waste.

Correct disposal of your old product helps to prevent potential negative consequences for the environment and human health.



Your product contains batteries covered by the European Directive 2006/66/EC, which cannot be disposed with normal household waste. Please inform yourself about the local rules on separate collection of batteries because correct disposal helps to prevent negative consequences for the environmental and human health.

Help and support

For extensive online support, visit www.philips.com/support to:

- download the user manual and the quick start guide
- watch video tutorials (available only for selected models)

- find answers to frequently answered questions (FAQs)
- email us a question
- chat with our support representative.

Follow the instructions on the website to select your language, and then enter your product model number.

Alternatively, you can contact Consumer Care in your country. Before you contact, note down the model number and serial number of your product. You can find this information on the back or bottom of your product.

Compliance

CE 0560

This product complies with the radio interference requirements of the European Community.

Hereby, WOOX Innovations, declares that this product is in compliance with the essential requirements and other relevant provisions of Directive 1999/5/EC.

A copy of the EC declaration of Conformity is available in the Portable Document Format (PDF) version of the user manual at www.philips.com/support.

2 Your SoundStage

Congratulations on your purchase, and welcome to Philips! To fully benefit from the support that Philips offers (e.g. notification of product software upgrade), register your product at www.philips.com/welcome.

Main unit

This section includes an overview of the main unit.

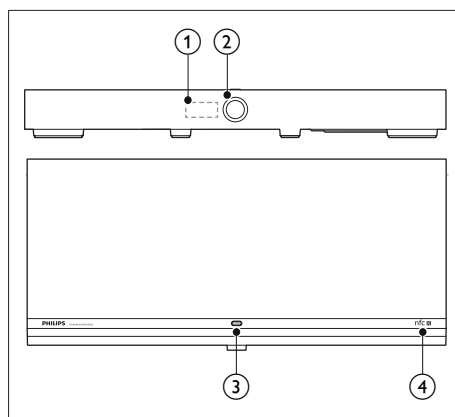

- ① **LED display**
- ② **⏻**
 - Press to switch the SoundStage on or off.
 - Rotate to adjust the volume.
- ③ **SOURCE**
Select an input source or Bluetooth mode for the SoundStage.
- ④ **NFC tag**
Tap the NFC-enabled device on the tag for Bluetooth connection.

Remote control

This section includes an overview of the remote control.

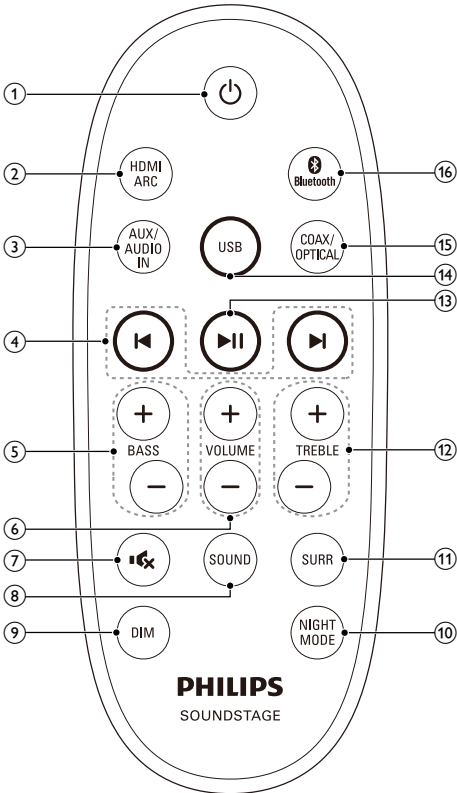

- ① **Power**
- Switch the SoundStage on or off.
 - When EasyLink is enabled, press and hold for at least three seconds to switch the connected HDMI devices to standby.

- ② **HDMI ARC**
- Switch your source to HDMI ARC connection. HDMI ARC can only be selected if you connect your SoundStage to an HDMI ARC compliant TV through HDMI ARC.

- ③ **AUX/AUDIO IN**
- Press repeatedly to switch your audio source to the AUX connection or MP3 connection (3.5mm jack).
- ④ **Navigation**
- Skip to the previous or next track in USB mode and Bluetooth mode (only for AVRCP-supported Bluetooth devices).
- ⑤ **BASS +/-**
- Increase or decrease bass.
- ⑥ **VOLUME +/-**
- Increase or decrease the volume.
- ⑦ **Mute**
- Mute or restore the volume.
- ⑧ **SOUND**
- Select a sound mode.
- ⑨ **DIM**
- Set the brightness of SoundStage display panel.
- ⑩ **NIGHT MODE**
- Turn night mode on or off.
- ⑪ **SURR**
- Select stereo or virtual surround sound.
- ⑫ **TREBLE +/-**
- Increase or decrease treble.
- ⑬ **Play/Pause**
- Start, pause or resume play in USB mode and Bluetooth mode (only for AVRCP-supported Bluetooth devices).
- ⑭ **USB**
- Switch to USB mode.
- ⑮ **COAX/OPTICAL**
- Press repeatedly to switch your audio source to the coaxial or optical connection.
- ⑯ **Bluetooth**
- Switch to Bluetooth mode.

Connectors

This section includes an overview of the connectors available on your SoundStage.

Side connectors

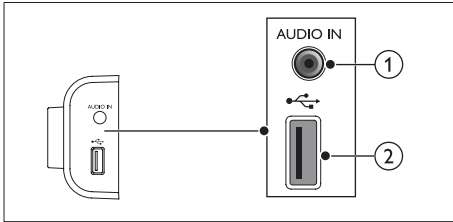

- ① **AUDIO IN**
Audio input from an MP3 player (3.5mm jack).
- ② 
Audio input from a USB storage device.

Rear connectors

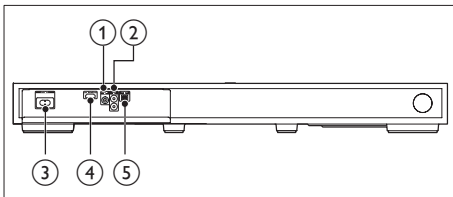

- ① **COAXIAL IN**
Connect to a coaxial audio output on the TV or other devices.
- ② **AUX IN**
Connect to an audio output on the TV or other devices.
- ③ **AC MAINS~**
Connect to the power supply.
- ④ **HDMI OUT (ARC)**
Connect to the HDMI input on the TV.
- ⑤ **OPTICAL IN**
Connect to an optical audio output on the TV or other devices.

3 Place your SoundStage

This SoundStage is designed to be placed under your TV.

! Caution

- The SoundStage is designed for TVs that weigh no more than 24 kg. Do not place a CRT type TV on the SoundStage.
- Do not place the SoundStage on an unstable cart, stand, bracket or table. Otherwise, the SoundStage may fall, causing serious injury to a child or adult and serious damage to the product.
- Make sure the ventilation openings on the rear panel are not blocked.
- Do not change the position of the SoundStage after placing your TV on top of it.

- 1 Place the SoundStage on any flat and stable surface near your TV. Then place your TV on the top of the SoundStage.

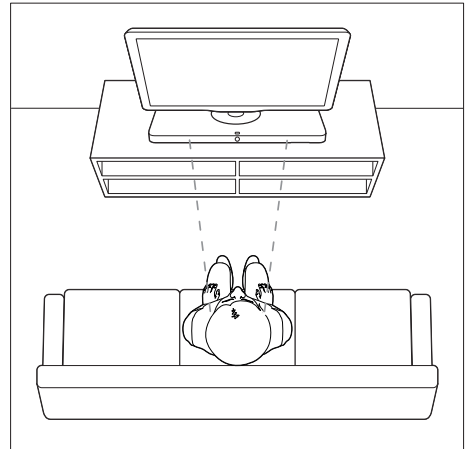

- 2 Make sure the TV base is centered on it and not hanging over any of its edges.

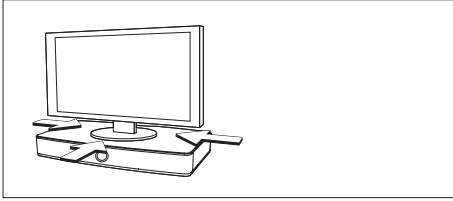

 Tip

- If the TV base is too large to put on top of the SoundStage, place the SoundStage in another location such as on an open shelf under the TV, but keep it close to your TV so the audio cable will reach. You can also mount your TV on the wall above the SoundStage.
- If your TV comes with an anti-tip device, install it according to the manufacturer's instructions and adjust the tether after placing the TV on top of the SoundStage.
- If placing the SoundStage in a cabinet or on a shelf, for optimum audio performance, make sure the front of the SoundStage is as close as possible to the front edge of the shelf.
- If placing the SoundStage backed up to a wall, make sure there is at least a distance of 1 inch between the wall and the rear of the SoundStage.

4 Connect and set up

This section helps you connect your SoundStage to a TV and other devices, and then set it up.

For information about the basic connections of your SoundStage and accessories, see the Quick start guide.

 Note

- For identification and supply ratings, see the type plate at the back or bottom of the product.
- Before you make or change any connections, make sure that all devices are disconnected from the power outlet.

Connect to TV

Connect your SoundStage to a TV to watch videos. You can listen to the TV audio through your SoundStage.

Use the best quality connection available on your SoundStage and TV.

Connect to TV through HDMI (ARC)

Best quality audio

Your SoundStage supports HDMI with Audio Return Channel (ARC). If your TV is HDMI ARC compliant, you can hear the TV audio through your SoundStage by using a single HDMI cable.

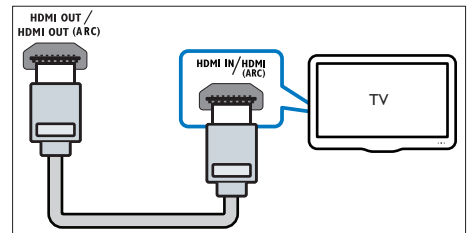

- Using a High Speed HDMI cable, connect the **HDMI OUT (ARC)** connector on your SoundStage to the **HDMI ARC** connector on the TV.
 - The **HDMI ARC** connector on the TV might be labeled differently. For details, see the TV user manual.
- On your TV, turn on HDMI-CEC operations. For details, see the TV user manual.

Note

- If your TV is not HDMI ARC compliant, connect an audio cable to hear the TV audio through your SoundStage.
- If your TV has a DVI connector, you can use an HDMI/DVI adapter to connect to TV. However, some of the features may not be available.

Connect audio from TV and other devices

Play audio from TV or other devices through your SoundStage speakers. Use the best quality connection available on your TV, SoundStage, and other devices.

Note

- When your SoundStage and TV are connected through **HDMI ARC**, an audio connection is not required.

Option 1: Connect audio through a digital optical cable

Best quality audio

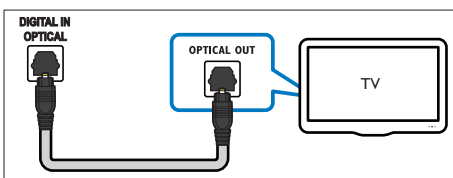

- Using an optical cable, connect the **OPTICAL IN** connector on your SoundStage to the **OPTICAL OUT** connector on the TV or other device.
 - The digital optical connector might be labeled **SPDIF** or **SPDIF OUT**.

Option 2: Connect audio through a digital coaxial cable

Good quality audio

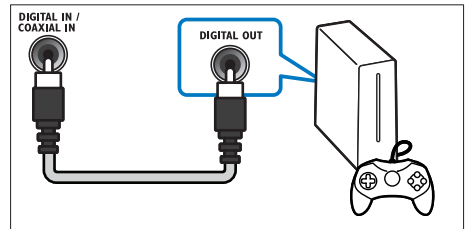

- Using a coaxial cable, connect the **COAXIAL IN** connector on your SoundStage to the **COAXIAL/DIGITAL OUT** connector on the TV or other device.
 - The digital coaxial connector might be labeled **DIGITAL AUDIO OUT**.

Option 3: Connect audio through analog audio cables

Basic quality audio

- Using an analog cable, connect the **AUX IN** connector on your SoundStage to the **AUDIO OUT** connectors on the TV or other device.

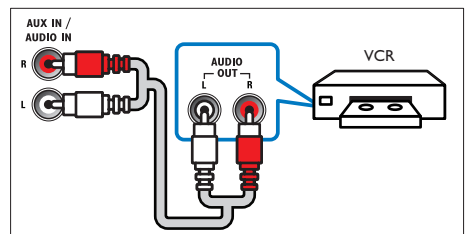

5 Use your SoundStage

This section helps you use the SoundStage to play media from a wide range of sources.

Before you start

- Make the necessary connections described in Quick start guide and User manual.
- Switch the TV to the correct source for the SoundStage.

Adjust the volume

- 1 Rotate the power knob or press **VOLUME +/-** on remote control to increase or decrease a volume level.
 - To mute sound, press **MUTE**.
 - To restore the sound, press **MUTE** again or press **VOLUME +/-**.

Choose your sound

This section helps you choose the ideal sound for your video or music.

Surround sound mode

Experience an immersive audio experience with surround sound modes.

- 1 Press **SURR** repeatedly to select surround mode or stereo mode.

Equalizer

Change the high frequency (treble) and low frequency (bass) settings of the SoundStage.

- 1 Press **TREBLE +/-** or **BASS +/-** to change the treble or bass level.

Night mode

For quiet listening, night mode decreases the volume of loud sounds when audio is played. Night mode is only available for Dolby Digital soundtracks.

- 1 Press **NIGHT MODE** to turn night mode on or off.

MP3 player

Connect your MP3 player to play your audio files or music.

What you need

- An MP3 player.
 - A 3.5mm stereo audio cable.
- 1 Using the 3.5mm stereo audio cable, connect the MP3 player to the **AUDIO IN** connector on your SoundStage.
 - 2 Press **AUDIO IN** on the remote control.
 - 3 Press the buttons on the MP3 player to select and play audio files or music.

Play audio through Bluetooth

Through Bluetooth, connect the SoundStage with your Bluetooth device (such as an iPad, iPhone, iPod touch, Android phone, or laptop), and then you can listen to the audio files stored on the device through your SoundStage.

What you need

- A Bluetooth device which supports Bluetooth profile A2DP, AVRCP and with Bluetooth version as 3.0 + EDR.
- The operational range between the SoundStage and a Bluetooth device is approximately 10 meters (30 feet).

- 1 Press **Bluetooth** on the remote control to switch the SoundStage to Bluetooth mode.
↳ **[BT]** is displayed.

- 2 On the Bluetooth device, switch on Bluetooth, search for and select **PhilipsHTL4111B** to start connection (see the user manual of the Bluetooth device on how to enable Bluetooth).
- 3 Wait until you hear a beep sound from the SoundStage.
 - ↳ **[BT]** is displayed.
 - ↳ If the connection fails, **[BT]** is flashed.
- 4 Select and play audio files or music on your Bluetooth device.
 - During play, if a call is coming, music play is paused. Play resumes when the call ends.
 - If your Bluetooth device supports AVRCP profile, on the remote control you can press **◀/▶** to skip to a track, or press **▶||** to pause/resume play.
- 5 To exit Bluetooth, select other source.
 - When your switch back to Bluetooth mode, Bluetooth connection remains active.

Note

- The music streaming may be interrupted by obstacles between the device and SoundStage, such as wall, metallic casing that covers the device, or other devices nearby that operate in the same frequency.
- If you want to connect your SoundStage with another Bluetooth device, press and hold **Bluetooth** on the remote control to disconnect the currently connected Bluetooth device.

Play music via NFC

NFC (Near Field Communication) is a technology that enables short-range wireless communication between NFC-enabled devices, such as mobile phones.

What you need

- A Bluetooth device with NFC function.
- For pairing, tap the NFC device on the **NFC** tag of this product.

- The operational range between the main unit (left and right speakers) and a NFC device is approximately 10 meters (30 feet).
- 1 Enable NFC on your Bluetooth device (see the user manual of your device for details).
 - 2 Tap the NFC device on the **NFC** tag of this product until you hear a beep sound from this product.
 - ↳ The NFC device is connected to this product via Bluetooth. **[BT]** is displayed.
 - 3 Select and play audio files or music on your NFC device.
 - To break the connection, tap the NFC device with the **NFC** tag on this product again.

USB storage devices

Enjoy audio on a USB storage device, such as an MP3 player and USB flash memory, etc.

What you need

- A USB storage device that is formatted for FAT or NTFS file systems, and complies with the Mass Storage Class.
- A USB extension cable, if the USB storage device does not fit into the connector.
- An MP3 or WMA file on a USB storage device.

- 1 Connect a USB storage device to the SoundStage.
- 2 Press **USB** on the remote control.
 - ↳ **[USB]** is displayed.
- 3 Use the remote control to control play.

Button	Action
▶ 	Start, pause or resume play.
◀/▶	Skip to the previous or next track.

Note

- This product may not be compatible with certain types of USB storage device.
- If you use a USB extension cable, USB HUB, or USB multi-reader, the USB storage device may not be recognized.
- Digital camera PTP protocols are not supported.
- Do not remove the USB storage device while it is being read.
- DRM-protected music files (MP3, WMA) are not supported.
- Support a USB port: 5V ---, 1A.

Auto standby

When playing media from a connected device, the SoundStage automatically switches to standby if:

- no button is pressed for 18 minutes, or
- no audio/video play from a connected device (except USB) for 18 minutes.

Apply factory settings

You can reset this product to the default settings programmed at the factory.

- 1 In standby mode, press and hold  button on the main unit for at least 5 seconds until the product powers on.



6 Update software

To get the best features and support, update your product with the latest software.

Check software version

- 1 In any source mode, press .
- 2 Press **AUX/AUDIO IN** twice on the remote control.
 - ↳ The software version number is displayed.

Update software via USB

- 1 Check the latest software version on www.philips.com/support.
 - Search for your model and click on "Software and drivers".
- 2 Download the software into a USB storage device.
 - ① **Unzip the download if zipped, and make sure that the unzipped folder is named "HTL4111B_12.BIN".**
 - ② **Put the "HTL4111B_12.BIN" folder in the root directory.**
- 3 Connect the USB storage device to the USB connector of this product.
- 4 Press **USB** on the remote control, within 5 seconds press  twice, and **VOL +** once, then hold down .
 - ↳ If an upgrade file is detected, [UPG] will be fast flashed.
 - ↳ If an upgrade file is not detected, [ERROR] will be slowly flashed.
- 5 Press  to start the update.
 - ↳ [UPG] is displayed.

- 6 Wait until the update is completed.
↳ If the update is complete, this product automatically turns off and on again.

! Caution

- Do not turn off the power or remove the USB storage device when the software update is in progress because you might damage this product.

7 Product specifications

≡ Note

- Specifications and design are subject to change without notice.

Amplifier

- Total output power: 80W RMS (+/- 0.5 dB, 10%THD)
- Frequency response: 20 Hz-20 kHz / ± 3 dB
- Signal-to-noise ratio: > 65 dB (CCIR) / (A-weighted)
- Input sensitivity:
 - AUX: 2 V rms
 - AUDIO IN: 1 V rms

Audio

- S/PDIF Digital audio input:
 - Coaxial: IEC 60958-3
 - Optical: TOSLINK

USB

- Compatibility: Hi-Speed USB (2.0)
- Class support: USB Mass Storage Class (MSC)
- File system: FAT16, FAT32, NTFS
- Maximum memory support: < 64 GB
- Supports MP3 and WMA file formats
- Sampling frequency:
 - MP3: 8 kHz, 11 kHz, 12 kHz, 16 kHz, 22 kHz, 24 kHz, 32 kHz, 44.1 kHz, 48 kHz
 - WMA: 44.1 kHz, 48 kHz
- Constant bit rate:
 - MP3: 8 kbps-320 kbps
 - WMA: 32 kbps-192 kbps
- Version:
 - WMA: V7, V8, V9

Bluetooth

- Bluetooth profiles: A2DP, AVRCP
- Bluetooth version: 3.0 + EDR

Main unit

- Power supply: 110-240 V~, 50/60 Hz
- Power consumption: 20 W
- Standby power consumption: ≤ 0.5 W
- Speaker impedance: 4 ohm
- Speaker drivers: 2 x racetrack mid range (1.5" x 5") + 2 x 1" tweeter + 1 x 4" woofer
- Dimensions (WxHxD): 701 x 68 x 325 mm
- Weight: 6.3 kg
- Operating temperature and humidity: 0°C to 45°C, 5% to 90% humidity for all climates
- Storage temperature and humidity: -40°C to 70°C, 5% to 95%

Remote control batteries

- 1 x CR2025

Standby information

- When the product remains inactive for 18 minutes, it automatically switches to standby or networked standby.
- The power consumption in standby or networked standby is less than 0.5W.
- To deactivate Bluetooth connection, press and hold the Bluetooth button on the remote control.
- To activate Bluetooth connection, enable Bluetooth connection on your Bluetooth device, or enable Bluetooth connection via the NFC tag (if available).

8 Troubleshooting



Warning

- Risk of electric shock. Never remove the casing of the product.

To keep the warranty valid, never try to repair the product yourself.

If you have problems using this product, check the following points before you request service.

If you still have a problem, get support at www.philips.com/support.

Main unit

The buttons on the SoundStage do not work.

- Disconnect the SoundStage from the power supply for a few minutes, then reconnect.

Sound

No sound from SoundStage speakers.

- Connect the audio cable from your SoundStage to your TV or other devices. However, you do not need a separate audio connection when the SoundStage and TV are connected through **HDMI ARC** connection.
- Reset your SoundStage to its factory settings.
- On the remote control, select the correct audio input.
- Make sure that the SoundStage is not muted.

Distorted sound or echo.

- If you play audio from the TV through the SoundStage, make sure that the TV is muted.

Bluetooth

A device cannot connect with the SoundStage.

- The device does not support the compatible profiles required for the SoundStage.
- You have not enabled the Bluetooth function of the device. See the user manual of the device on how to enable the function.
- The device is not correctly connected. Connect the device correctly.
- The SoundStage is already connected with another Bluetooth device. Disconnect the connected device, then try again.

Quality of audio play from a connected Bluetooth device is poor.

- The Bluetooth reception is poor. Move the device closer to the SoundStage, or remove any obstacle between the device and the SoundStage.

The connected Bluetooth device connects and disconnects constantly.

- The Bluetooth reception is poor. Move the device closer to the SoundStage, or remove any obstacle between the device and the SoundStage.
- Turn off Wi-Fi function on the Bluetooth device to avoid interference.
- For some Bluetooth, the Bluetooth connection can be deactivated automatically to save power. This does not indicate any malfunction of the SoundStage.

NFC

A device cannot connect with this product via NFC.

- Make sure that the device is supported by NFC.
- Make sure that NFC is enabled on the device (see the device's user manual for details).
- For pairing, tap the NFC device on the **NFC** tag of this product.



Manufactured under license from Dolby Laboratories. Dolby and the double-D symbol are trademarks of Dolby Laboratories.



The Bluetooth® word mark and logos are registered trademarks owned by Bluetooth SIG, Inc. and any use of such marks by WOOX Innovations is under license.



The terms HDMI and HDMI High-Definition Multimedia Interface, and the HDMI Logo are trademarks or registered trademarks of HDMI Licensing LLC in the United States and other countries.



The N Mark is a trademark of NFC Forum, Inc. in the United States and in other countries.

HK-WK1444-HTL4110B

(Document No. / Numéro du document)

2013/09

(yyyy/mm in which the CE mark is affixed / aaaa/mm
au cours de laquelle le marquage CE a été apposé)

EUROPEAN DECLARATION OF CONFORMITY

(DECLARATION DE CONFORMITE CE)

We, WOOX INNOVATIONS NETHERLANDS B.V.

(Company name / Nom de l'entreprise)

Building SFH4, Kastanjelaan 400, 5616 LZ Eindhoven, The Netherlands

(address / adresse)

declare under our responsibility that the product(s):

(déclarons sous notre propre responsabilité que le(s) produit(s))

PHILIPS

(brand name, nom de la marque)

Soundstage Speaker

(product description, description du produit)

HTL4111B/12 HTL4110B/12

(Type version or model, référence ou modèle)

to which this declaration relates is in conformity with the following harmonized standards:

(auquel cette déclaration se rapporte, est conforme aux normes harmonisées suivantes)

EN60065:2002+A1:2006+A11:2008+A2:2010+A12:2011

EN55013:2001+A1:2003+A2:2006

EN55020:2007+A11:2011

EN61000-3-2:2006+A1:2009+A2:2009

EN61000-3-3:2008

EN62479:2010

EN50564: 2011

EN50581:2012

EN300328 V1.8.1:2012

EN 301489-1 V1.9.2:2011

EN301489-17 V2.2.1:2012

following the provisions of:

(conformément aux exigences essentielles et autres dispositions pertinentes de:)

1999/5/EC

2006/95/EC

2004/108/EC

2011/65/EU

2009/125/EC - EC/1275/2008, EC/801/2013

And are produced under a quality scheme at least in conformity with ISO 9001 or CENELEC Permanent Documents

(Et sont fabriqués conformément à une qualité au moins conforme à la norme ISO 9001 ou aux Documents Permanents CENELEC)

Only for R&TTE products:

The Notified Body: CE0560
(L'Organisme Notifié) (Name and number/ nom et numéro)

performed: N/A
(a effectué)

and issued the certificate: 13214151/AA/01
(et a délivré le certificat) (certificate number / numéro du certificat)

Matthias Pyroth, Director of Consumer Care
(signature, name and function / signature, nom et fonction)

Eindhoven, 07/11/14
(place, date / lieu, date)



Specifications are subject to change without notice

2014 © WOOX Innovations Limited. All rights reserved.

Philips and the Philips' Shield Emblem are registered trademarks of Koninklijke Philips N.V. and are used by WOOX Innovations Limited under license from Koninklijke Philips N.V.

HTL4111B_12_UM_V3.0

