

PHILIPS

Party Speaker

3000 Series

TAX3305

User manual



Register your product and get support at
www.philips.com/support

Contents

1 Important	2	8 Other features	15
Safety	2	Play music from an external device	15
<hr/>		Change the speaker light effect	15
2 Your party speaker system	4	Charge the battery	15
Introduction	4	<hr/>	
What's in the box	4	9 Product information	16
Overview of the main unit	5	Specifications	16
<hr/>		USB and SD card playability information	17
3 Get started	9	Maintenance	17
Connect power	9	<hr/>	
Turn on	10	10 Troubleshooting	18
<hr/>		About Bluetooth device	18
4 Play audio through Bluetooth	11	<hr/>	
Connect a device manually	11	11 Notice	19
Play from Bluetooth device	11	Care of the environment	19
Disconnect a device	11	Trademark notice	19
PAIR button function	11	<hr/>	
<hr/>			
5 Play from USB or SD card	12		
Play from a USB or SD card storage device	12		
Control play	12		
<hr/>			
6 FM radio	13		
Turn on FM radio	13		
Scan for channels	13		
Save the channels	13		
Play the saved channels	13		
<hr/>			
7 Record function	14		
<hr/>			

1 Important

Safety

Know these safety symbols



This 'bolt of lightning' indicates uninsulated material within your unit may cause an electrical shock. For the safety of everyone in your household, please do not remove product covering.

The 'exclamation point' calls attention to features for which you should read the enclosed literature closely to prevent operating and maintenance problems.

WARNING: To reduce the risk of fire or electric shock, this apparatus should not be exposed to rain or moisture and objects filled with liquids, such as vases, should not be placed on this apparatus.

CAUTION: To prevent electric shock, match wide blade of plug to wide slot, fully insert.

Warning

- Never remove the casing of this device.
 - Never lubricate any part of this device.
 - Never place this device on other electrical equipment.
 - Keep this device away from direct sunlight, naked flames or heat.
 - Never look into the laser beam inside this device.
 - Ensure that you always have easy access to the power cord, plug, or adaptor to disconnect this device from the power.
- Do not use this apparatus near water.
 - Install in accordance with the manufacturer's instructions.
 - Do not install near any heat sources such as radiators, heat registers, stoves, or other apparatus (including amplifiers) that produce heat.

- Protect the power cord from being walked on or pinched, particularly at plugs, convenience receptacles, and the point where they exit from the apparatus.
- Only use attachments/accessories specified by the manufacturer.
- Use only with the cart, stand, tripod, bracket, or table specified by the manufacturer or sold with the apparatus. When a cart is used, use caution when moving the cart/apparatus combination to avoid injury from tip-over.



- Unplug this apparatus during lightning storms or when unused for long periods of time.
- Refer all servicing to qualified service personnel. Servicing is required when the apparatus has been damaged in any way, such as power-supply cord or plug is damaged, liquid has been spilled or objects have fallen into the apparatus, the apparatus has been exposed to rain or moisture, does not operate normally, or has been dropped.
- Battery usage CAUTION – To prevent battery leakage which may result in bodily injury, property damage, or damage to the remote control:
 - Install the battery correctly, + and - as marked on the remote control.
 - Do not mix batteries (old and new or carbon and alkaline, etc.).
 - Remove the battery when the remote control is not used for a long time.
- The battery shall not be exposed to excessive heat such as sunshine, fire or the like.
- Apparatus shall not be exposed to dripping or splashing.
- Do not place any sources of danger on the apparatus (e.g. liquid filled objects, lighted candles).

- Where the MAINS plug or an appliance coupler is used as the disconnect device, the disconnect device shall remain readily operable.



Caution

- Use of controls or adjustments or performance of procedures other than herein may result in hazardous laser exposure or other unsafe operation.

2 Your party speaker system

Congratulations on your purchase, and welcome to Philips! To fully benefit from the support that Philips offers, register your product at www.philips.com/support.

Introduction

With this product, you can

- Enjoy audio from Bluetooth enabled devices, USB and SD card storage devices, or other external devices.
- Enjoy microphone and guitar function.
- Enjoy FM radio.

What's in the box

Check and identify the contents of your package:

- Main unit x 1
- AC Power cord x 1
- Remote control x 1
- AAA Batteries x 2
- 3.5mm to 2-RCA adapter audio cable x 1
- QSG x 1
- Warranty Card x 1
- Safety Sheet x 1

Overview of the main unit

TOP PANEL:

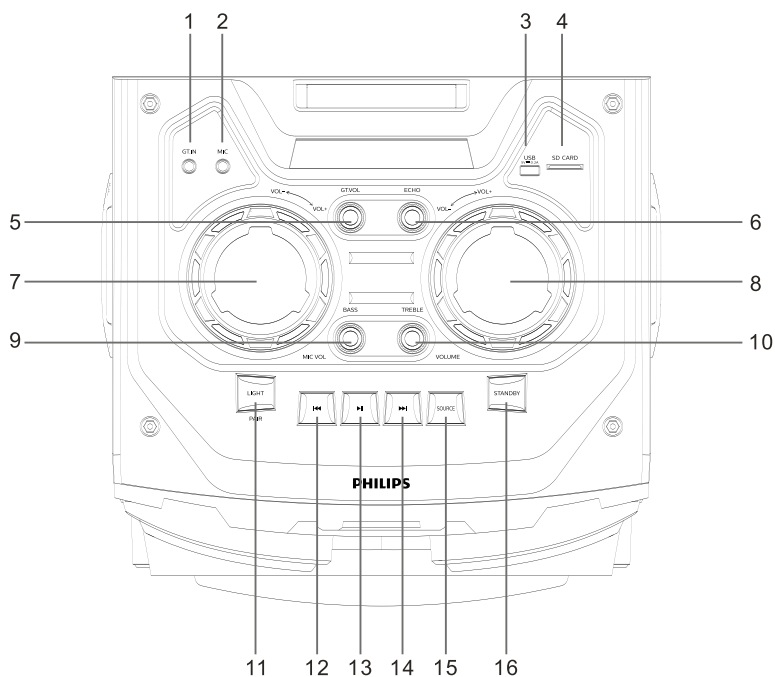

1.**GT.IN:** Guitar Input

2.**MIC:** Microphone Input

3.**USB:** USB Port

4.**SD CARD:** SD Card Slot

5.**GT.VOL:** Adjust the guitar volume.

6.**ECHO:** Adjust to control amount of Echo.

7.**MIC VOL-/VOL+:** Control the microphone volume in any mode.

8.**VOLUME VOL-/VOL+:** Control the Bluetooth/FM Radio/AUX Input/USB Input/SD Input volume.

9.**BASS:** Adjust the bass level.

10.**TREBLE:** Adjust the treble level.

11. **LIGHT/PAIR:** Short press to switch the speaker light mode; long press PAIR to enter pair mode or disconnect existing paired Bluetooth device.

- 12. ◀◀** : In USB/SD/Bluetooth mode, press to skip to the previous track; in FM mode, press to search FM channel manually.
- 13. ▶▶** : In USB/SD/Bluetooth mode, press ▶▶ to pause or resume play; in FM mode, long press to search and save FM channels automatically; short press to select the saved channel. In recording function, press to stop the recording and return to the current source.
- 14. ▶▶** : In USB/SD/Bluetooth mode, press to skip to the next track; in FM mode, press to search FM channel manually.
- 15.SOURCE**: Press to select the input source between Bluetooth/FM Radio/ Aux Input/USB Input/SD Input.
- 16.STANDBY**: Long press to turn on or turn off the speaker.

Overview of the main unit

REAR PANEL:

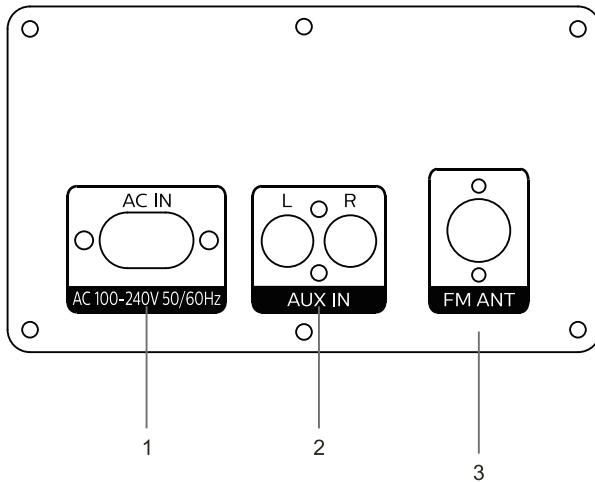

- 1.AC IN:** Connect the AC cable to get power supply and charge the battery.
- 2.AUX IN:** Connect the external device in AUX mode.
- 3.FM ANT:** For FM Radio.

Overview of the main unit

REMOTE CONTROL:

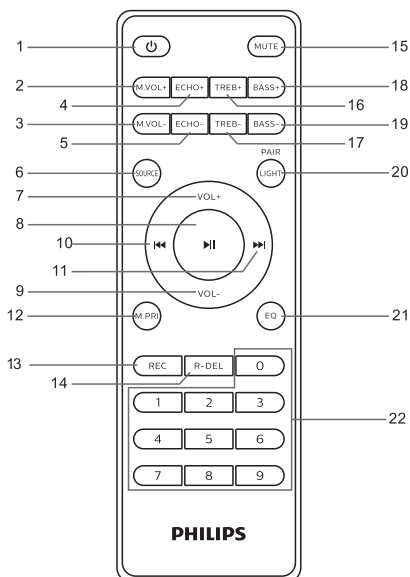

1. ⏻ : Short press to turn on and turn off the speaker.
2. M.VOL+: Increase the Microphone Volume.
3. M.VOL-: Decrease the Microphone Volume.
4. ECHO+: Increase the Microphone Echo.
5. ECHO-: Decrease the Microphone Echo.
6. SOURCE: Select the input source between: Bluetooth/FM Radio/Aux Input/USB Input/SD Input.
7. VOL+: Increase the master volume.
8. ▶|| : In USB/SD/Bluetooth mode, this button is Play/Pause; in FM mode, long press to search and save FM channels automatically; short press to select the saved channel; in recording function, press to stop the recording and return to the current source.
9. VOL-: Decrease the master volume.
10. ◀◀ : In USB/SD/Bluetooth mode, press to skip to the previous track; in FM mode, press to search FM channel manually.

- 11. ►►** : In USB/SD/Bluetooth mode, press to skip to the next track; in FM mode, press to search FM channel manually.
- 12.M.PRI**: When Microphone voice is detected, music level is automatically ducked.
- 13.REC**: Short press to record the microphone audio to USB or SD card; long press to play the record content, or return to the current source when playing the record content.
- 14.R-DEL**: When playing the record content, press to delete the record content.
- 15.MUTE**: Press to mute or unmute the sound in any mode.
- 16.TREB+**: Increase the treble.
- 17.TREB-**: Decrease the treble.
- 18.BASS+**: Increase the bass.
- 19.BASS-**: Decrease the bass.
- 20. LIGHT/PAIR**: Short press to change the speaker light mode; long press to enter pairing mode or disconnect existing paired Bluetooth device.
- 21.EQ**: Select the EQ between: NORM/CLASSICAL/POP/ROCK/JAZZ.
- 22.0-9**: In USB/SD mode, press to select the track you want; in FM mode, press to select the channel that has been searched and saved.

3 Get started



Caution

- Use of controls or adjustments or performance of procedures other than herein may result in hazardous laser exposure or other unsafe operation.

Always follow the instructions in this chapter in sequence.

If you contact Philips, you will be asked for the model and serial number of this apparatus. The model number and serial number are on the back of the apparatus. Write the numbers here:

Model No. _____

Serial No. _____

Connect power



Caution

- Risk of product damage! Make sure that the power supply voltage corresponds to the voltage printed on the back or the underside of the product.
- Risk of electric shock! When you unplug the power cord, always pull the plug from the socket. Never pull the cord.



Note

- Before connecting to AC power, make sure that you have completed all other connections.

Connect the AC power cord to the AC IN jack on the rear panel of the unit, then Plug the other end of the AC power cord into a power outlet.

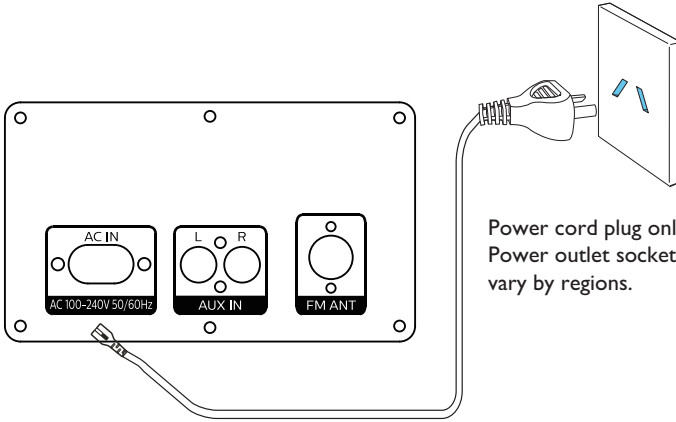

Power cord plug only available TAX3305/77.
Power outlet socket and plug of power cord
vary by regions.

Turn on

Press .

- ↳ Long press the **STANDBY** button on top panel to turn on/off the speaker, or short press the “” button on remote control to turn on/off the speaker.

4 Play audio through Bluetooth

Connect a device manually

- 1 Press the **SOURCE** button on the unit or remote control to switch the speaker to Bluetooth mode. You can see "BLUE" text display on the screen and the Bluetooth logo blinks, and the speaker light flashes for a few seconds.
- 2 On the Bluetooth device, switch on Bluetooth, search for and select **[Philips TAX3305]** to start connection. You will hear the prompt sound when the connection is successful. The Bluetooth indicator keeps solid.
- 3 To exit Bluetooth, switch the speaker to another source. When you switch back to Bluetooth mode, Bluetooth connection remains active.

Play from Bluetooth device

After successful pairing and connection, play audio on the Bluetooth device.

- ↳ Audio streams from your Bluetooth device to this product.

PAIR button function

- 1 In Bluetooth mode, long press the composite **LIGHT/PAIR** button on the unit or long press the composite **LIGHT/PAIR** button on remote control to enter pairing mode. The speaker will connect the previous paired device. Or long press to disconnect existing paired Bluetooth device.
- 2 If you want to connect another device, long press the composite **LIGHT/PAIR** button on the unit or long press the composite **LIGHT/PAIR** button on remote control to disconnect the current connected Bluetooth device and then you can connect another device.

Note

- Before pairing a device with this product, read its user manual for Bluetooth compatibility.
- Any obstacle between this product and a Bluetooth device can reduce the operational range. Keep away from any other electronic device that may cause interference.
- The operational range between this product and a Bluetooth device is approximately 10 meters (30 feet).
- Before connecting another Bluetooth device, disconnect the current device first.

5 Play from USB or SD card

Play from a USB or SD card storage device

- 1 Long press the **STANDBY** button to turn on the speaker.
- 2 Insert the USB or SD device into the USB or SD socket, and the unit switches automatically to USB or SD play mode.

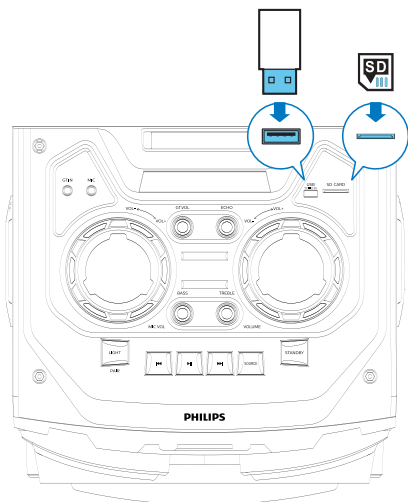

- 3 Press **⏮** / **⏭** to select an audio track.
↳ Play starts automatically.

Control play

In USB or SD mode, follow the instructions below to control play.

Button	Action
⏮ / ⏭	Press to skip to the previous or next track.
⏸	Press to pause or resume play.

Note

- Make sure that the USB or SD device contains playable audio contents in supported formats.
- USB supported audio formats: MP3, WMA, WAV
- SD supported audio format: MP3, WMA, WAV

6 FM radio

Turn on FM radio

Turn the speaker on and press **SOURCE** button until the display show the FM frequency. Be sure to extend the antenna on the back of the unit to strengthen the reception effect.

Scan for channels

Automatically: Long press the ►|| button on the unit or the remote control and the unit will automatically search for FM channels.

Manually: Short press the ◀◀ / ▶▶ button on the unit or the remote control until you hear the sound of an FM channel.

Save the channels

After the automatical searching finishes, the searched channels will be saved automatically and the first saved channel will be broadcast. The manual searching can not save channels.

Play the saved channels

Short press the ►|| button on the unit or the remote control to select and play the saved channels, or press the 0-9 number button on the remote control to select the saved channels directly.

7 Record function

The speaker can record your Microphone audio to USB or SD device. Please note that recording is only enabled when a USB or SD device and a microphone are attached. To begin recording, the speaker can be in either Bluetooth, AUX, USB, SD or FM mode. The input source cannot be switched during recording.

Turn the speaker on and press **REC** button on the remote control to begin recording. You will see the display change to a time readout (starting at 00:01) showing elapsed recording time. You may now begin your recording. When the recording is completed, press the **▶||** button to stop. Long press the **REC** button to play the record content. **R-DEL** button can delete the currently selected record content.



Note

- In AUX mode, audio from Mic and AUX input will be recorded.
- In Bluetooth, USB and SD mode, only Mic input will be recorded.
- In FM mode, audio from Mic and FM radio audio will be recorded.
- Insert your USB drive. The speaker will create a directory called "**REC**" in which your recordings will be put.

8 Other features

Play music from an external device

- 1 Turn the speaker on and press **SOURCE** button to select **AUX** mode.
- 2 Connect a 3.5mm to 2-RCA adapter audio cable with the connector on the device:
 - the AUX in RCA socket on the speaker.
 - the headphone jack on the device (MP3 player, cellphone, iPad, or other audio players).
- 3 Play audio on the device (refer to its user manual).

Change the speaker light effect

Turn the speaker on, and short press the composite **LIGHT/PAIR** button on top panel or remote control to change the speaker light mode:

Rhythmic light 01/ Rhythmic light 02/ Breathe flashing light 03 /Light off.

Charge the battery

When the battery level or battery power is less than 30%, the battery symbol on LED display will blink; when lower than 10%, there will be a prompt tone. You need to connect the AC power cord to the AC IN socket on the rear panel of the unit and the power outlet. LED indicator is solid red when it is charging, and it will turn solid green when the battery is fully charged. When your phone is connected to the speaker via Bluetooth, you could see the battery power symbol on the phone.

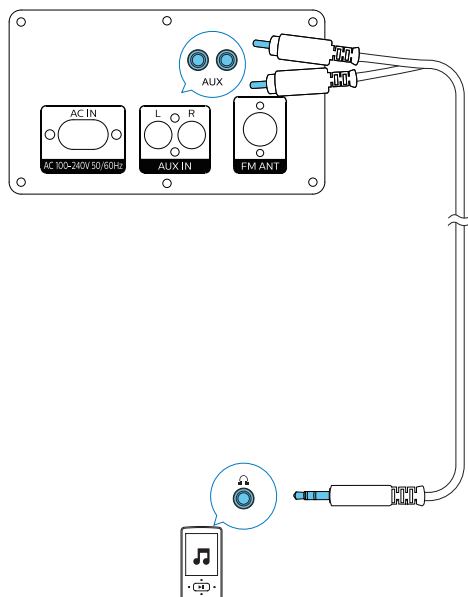

9 Product information

Specifications

Amplifier

AC Output Power	100W(peak)
Battery Output Power	100W(peak)
Frequency Response	40 Hz - 20 kHz; \pm 4dB
Signal to Noise Ratio	\geq 55 dBA
Total Harmonic Distortion	\leq 10 %

Speaker

Speaker Impedance	4 ohm
Sensitivity	90 \pm 3dB/m/W

USB

USB DirectVersion	2.0 Full Speed
-------------------	----------------

Bluetooth

Bluetooth Version	V4.2
Bluetooth Frequency Band	2.4 Ghz ~ 2.48 GHz ISM Band
Bluetooth Range	10 m(free space)

Battery

Battery capacity	Built in rechargeable 11.1V 4000mAh
------------------	--

General information

AC Power	100-240V~, 50/60 Hz
Eco Standby Power Consumption	\leq 1 W

Dimensions

Main Unit (W x D x H)	400 x 413 x 693mm
-----------------------	-------------------

Weight

Main Unit	13.0kg
-----------	--------

USB and SD card playability information

Compatible devices:

- USB flash memory (USB 2.0)
- USB flash players (USB 2.0)
- SD card

Supported formats:

- File formats: FAT, FAT12, FAT16, FAT32, exFAT
- Audio formats: MP3, WMA, WAV
- Maximum support 32G USB and SD Card.
(If USB or SD card is larger than 32G, the playback and record function can not be worked normally).

Maintenance

Clean the cabinet

- Use a soft cloth slightly moistened with a mild detergent solution. Do not use a solution containing alcohol, spirits, ammonia or abrasives.

10 Troubleshooting



Caution

- Never remove the casing of this unit.

To keep the warranty valid, never try to repair the system yourself.

If you encounter problems when using this unit, check the following points before requesting service. If the problem remains unsolved, go to the Philips web site (www.philips.com/support). When you contact Philips, ensure that your unit is nearby and the model number and serial number are available.

No power

- Make sure that the AC power plug of the unit is connected properly.
- Make sure that there is power at the AC outlet.
- To save power, the unit switches to standby automatically 15 minutes after a play reaches the end and no control is operated.

No sound or poor sound

- Adjust the volume.

No response from the unit

- Disconnect and reconnect the AC power plug, then turn on the unit again.

Cannot display some files in USB device

- The number of folders or files in the USB device has exceeded a certain limit. This phenomenon is not a malfunction.
- The formats of these files are not supported.

USB device not supported

- The USB device is incompatible with the unit. Try another one.

About Bluetooth device

The audio quality is poor after connection with a Bluetooth-enabled device.

- The Bluetooth reception is poor. Move the device closer to this product or remove any obstacle between them.

Cannot connect with the device.

- The Bluetooth function of the device is not enabled. Refer to the user manual of the device for how to enable the function.
- This product is already connected with another Bluetooth-enabled device. Disconnect that device and then try again.

The paired device connects and disconnects constantly.

- The Bluetooth reception is poor. Move the device closer to this product or remove any obstacle between them.
- For some devices, Bluetooth connection may be deactivated automatically as a power-saving feature. This does not indicate any malfunction of this product.

11 Notice

Any changes or modifications made to this device that are not expressly approved by **MMD Hong Kong Holding Limited** may void the user's authority to operate the equipment.

Care of the environment

Disposal of your old product and battery



Your product is designed and manufactured with high quality materials and components, which can be recycled and reused.



This symbol on a product means that the product is covered by European Directive 2012/19/EU.



This symbol means that the product contains batteries covered by European Directive 2013/56/EU which cannot be disposed of with normal household waste. Inform yourself about the local separate collection system for electrical and electronic products and batteries. Follow local rules and never dispose of the product and batteries with normal household waste. Correct disposal of old products and batteries helps prevent negative consequences for the environment and human health.

Removing the disposable batteries

To remove the disposable batteries, see battery installation section.

Environmental information

All unnecessary packaging has been omitted. We have tried to make the packaging easy to separate into three materials: cardboard (box), polystyrene foam (buffer) and polyethylene (bags, protective foam sheet.)

Your system consists of materials which can be recycled and reused if disassembled by a specialized company. Please observe the local regulations regarding the disposal of packaging materials, exhausted batteries and old equipment.



Caution

- Removal of the built-in battery invalidates the warranty and may destroy the product.

Always bring your product to a professional to remove the built-in battery.

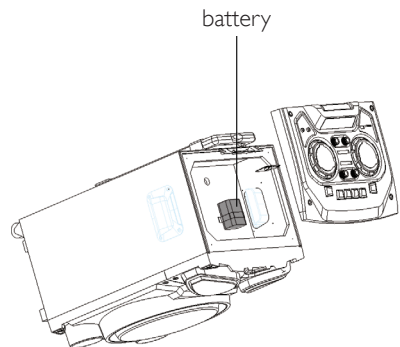

Trademark notice



The Bluetooth® word mark and logos are registered trademarks owned by Bluetooth SIG, Inc. and any use of such marks by **MMD Hong Kong Holding Limited** is under license. Other trademarks and trade names are those of their respective owners.



This is CLASS II apparatus with double insulation, and no protective earth provided.



**Be responsible
Respect copyrights**

The making of unauthorized copies of copy-protected material, including computer programs, files, broadcasts and sound recordings, may be an infringement of copyrights and constitute a criminal offence. This equipment should not be used for such purposes.



Specifications are subject to change without notice.

Please visit www.philips.com/support for the latest updates and documents.

Philips and the Philips Shield Emblem are registered trademarks of Koninklijke Philips N.V. and are used under license.

This product has been manufactured by and is sold under the responsibility of MMD Hong Kong Holding Limited, or one of its affiliates, and MMD Hong Kong Holding Limited, is the warrantor in relation to this product.

