

Mini Hi-Fi System

FWM185

User manual



PHILIPS

CAUTION

Use of controls or adjustments or performance of procedures other than herein may result in hazardous radiation exposure or other unsafe operation.

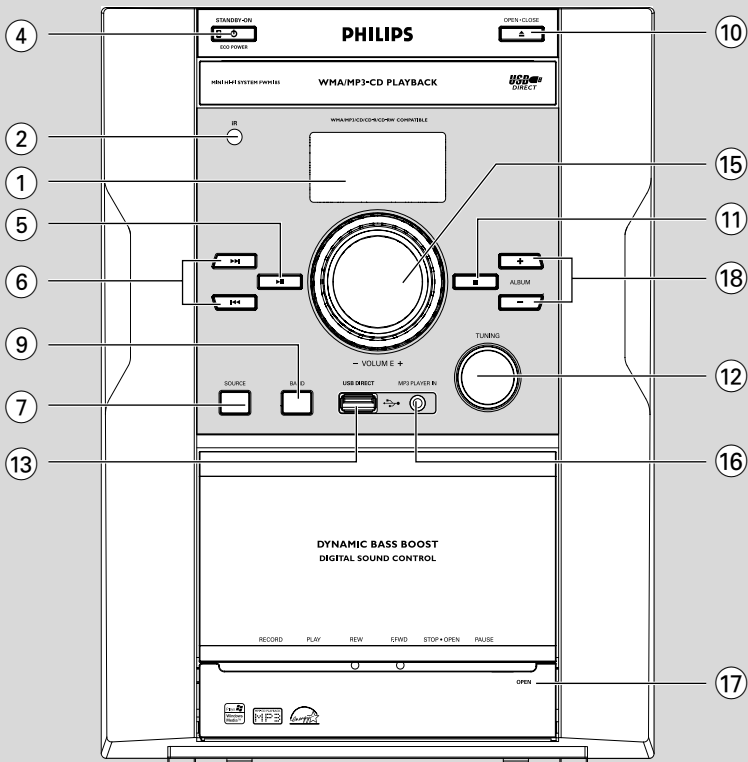
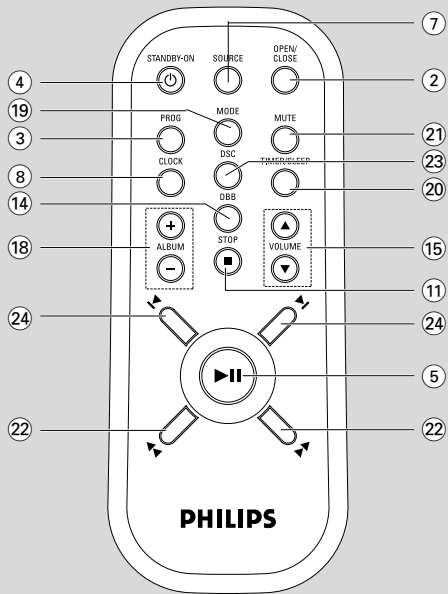

Contents

General Information

Supplied accessories	5
Environmental Information	5
Safety information	5

Preparation

Rear connections	6
Optional connection	7
Inserting batteries into the remote control ...	7

Controls

Controls on the system and remote control	8
---	---

Basic Functions

Switching the system on	9
Power-saving automatic standby	9
Adjusting volume and sound	9

CD/MP3/WMA Operation

Playing a disc	10
Selecting a different track	10
Finding a passage within a track	10
Playing an MP3/WMA disc	10-11
Discs for playback	11
Different play modes: Shuffle and Repeat	11
Programming track numbers	11
Erasing the programme	11

Radio Reception

Tuning to radio stations	12
--------------------------------	----

Tape Operation/Recording

Tape playback	13
General information on recording	13
Synchro start CD recording	13
Recording from the radio	14
Recording from external sources	14

External Sources

Using a USB mass storage device	15-16
Connecting external equipment	16

Clock/Timer

Setting the clock	17
Setting the sleep timer	17
Setting the timer	18

Specifications

.....	19
-------	----

Maintenance

.....	20
-------	----

Troubleshooting

.....	21-22
-------	-------

Supplied accessories

- 2 speaker boxes
- remote control
- MW loop antenna

Environmental Information

All unnecessary packaging has been omitted. We have tried to make the packaging easy to separate into three materials: cardboard (box), polystyrene foam (buffer) and polyethylene (bags, protective foam sheet).

Your system consists of materials which can be recycled and reused if disassembled by a specialized company. Please observe the local regulations regarding the disposal of packaging materials, exhausted batteries and old equipment.

Safety Information

- Before operating the system, check that the operating voltage indicated on the typeplate (or the voltage indication beside the voltage selector) of your system is identical with the voltage of your local power supply. If not, please consult your dealer.
- Place the system on a flat, hard and stable surface.
- Place the system in a location with adequate ventilation to prevent internal heat build-up in your system. Allow at least 10 cm (4 inches) clearance from the rear and the top of the unit and 5 cm (2 inches) from each side.
- The ventilation should not be impeded by covering the ventilation openings with items, such as newspapers, table-cloths, curtains, etc.
- Do not expose the system, batteries or discs to excessive moisture, rain, sand or heat sources caused by heating equipment or direct sunlight.
- No naked flame sources, such as lighted candles, should be placed on the apparatus.
- No objects filled with liquids, such as vases, shall be placed on the apparatus.
- The apparatus shall not be exposed to dripping or splashing.

- Install this unit near the AC outlet and where the AC power plug can be reached easily.
- If the system is brought directly from a cold to a warm location, or is placed in a very damp room, moisture may condense on the lens of the disc unit inside the system. Should this occur, the CD player would not operate normally. Leave the power on for about one hour with no disc in the system until normal playback is possible.
- The mechanical parts of the set contain self-lubricating bearings and must not be oiled or lubricated.
- **When the system is switched to Standby mode, it is still consuming some power. To disconnect the system from the power supply completely, remove the AC power plug from the wall socket.**

The making of unauthorized copies of copy-protected material, including computer programmes, files, broadcasts and sound recordings, may be an infringement of copyrights and constitute a criminal offence. This equipment should not be used for such purposes.



**Be responsible
Respect copyrights**

Preparations

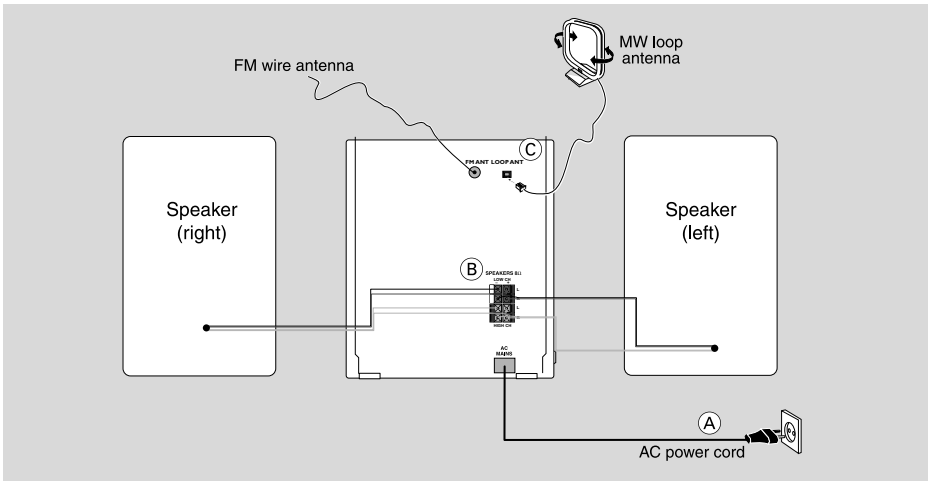

Rear connections

The type plate is located at the rear of the system.

(A) Power

- Before connecting the AC power cord to the wall outlet, ensure that all other connections have been made.

WARNING!

- For optimal performance, use only the original power cable.
- Never make or change any connections with the power switched on.
- High voltage! Do not open. You run the risk of getting an electric shock.
- The machine does not contain any user-serviceable parts.
- Modification of the product could result in hazardous radiation of EMC or other unsafe.

To avoid overheating of the system, a safety circuit has been built in. Therefore, your system may switch to Standby mode automatically under extreme conditions. If this happens, let the system cool down before reusing it (not available for all versions).

(B) Speakers Connection

Front Speakers

Connect the speaker wires to the SPEAKERS terminals, right speaker to "R" and left speaker to "L", red wires to "+" and black wires to "-" of the woofer connection terminals, blue wires to "+" and grey wires to "-" of the tweeter connection terminals.

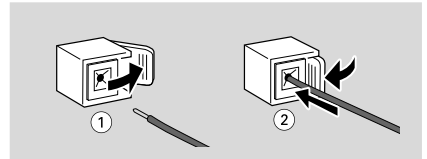

- Fully insert the stripped portion of the speaker wire into the terminal as shown.

Notes:

- For optimal sound performance, use the supplied speakers.
- Do not connect more than one speaker to any one pair of +/– speaker terminals.
- Do not connect speakers with an impedance lower than the speakers supplied. Please refer to the SPECIFICATIONS section of this manual.

C Antenna Connection

Connect the supplied MW loop antenna to the respective terminal. Adjust the position of the antenna for optimal reception.

MW Antenna

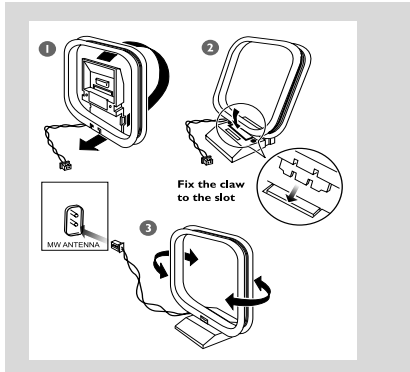

- Position the antenna as far as possible from a TV, VCR or other radiation source.

Optional connection

The optional equipment and connecting cords are not supplied. Refer to the operating instructions of the connected equipment for details.

Connecting a USB device or memory card

By connecting a USB mass storage device (including USB flash memory, USB flash players or memory cards) to the Hi-Fi system, you can enjoy the device's stored music through the powerful speakers of Hi-Fi system.

- Insert the USB device's USB plug into the  socket on the set.

For the devices with USB cables:

- 1 Insert one plug of the USB cable (not supplied) to the  socket on the set.
- 2 Insert the other plug of the USB cable to the USB output terminal of the USB device.

For the memory card:

- 1 Insert the memory card into a card reader (not supplied).

- 2 Use a USB cable (not supplied) to connect the card reader into the  socket on the set.

Connecting a non-USB device

Use a cinch cable to connect **MP3 PLAYER IN** to the analogue audio out terminals of an external equipment (TV, VCR, Laser Disc player, DVD player or CD Recorder).

Inserting batteries into the remote control

Insert two batteries type R03 or AAA into the remote control with the correct polarity as indicated by the "+" and "-" symbols inside the battery compartment.

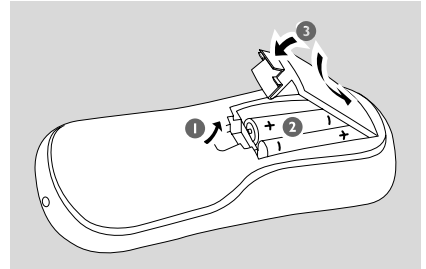











CAUTION!

- Remove batteries if they are exhausted or will not be used for a long time.
- Do not use old and new or different types of batteries in combination.
- Batteries contain chemical substances, so they should be disposed of properly.

Controls (illustrations on page 3)

Controls on the system and remote control

- ① **LCD Display**
 - shows the status of the system.
- ② **iR SENSOR**
 - infrared sensor for remote control.
- ③ **PROG**
 - programs CD tracks and reviews the program.
- ④ **ECO POWER/STANDBY ON** 
 - switches the system on or to Eco power/normal standby mode.
- ⑤ **▶||**
 - starts or pauses CD/USB playback.
- ⑥ **◀◀ / ▶▶**
 - skips to the beginning of a current track/previous/ next track.
 - (press and hold) fast searches back and forward within a track/disc.
- ⑦ **Source (CD/TAPE/TUNER/USB/MP3 IN)**
 - selects the respective sound source for CD/TAPE/TUNER/USB/MP3 IN.
- ⑧ **CLOCK**
 - sets the clock.
- ⑨ **BAND (MW/FM ST/FM MONO)**
 - selects waveband: MW, FM (stereo) or FM (mono).
- ⑩ **OPEN/CLOSE**
 - open/close the CD door.
- ⑪ **STOP** 
 - stops CD/USB playback or erases a CD program.
- ⑫ **TUNING**
 - tunes to a radio station.
- ⑬ **USB DIRECT**
 - connects an external USB mass storage device.
- ⑭ **DBB** (Dynamic Bass Boost)
 - enhances the bass.
- ⑮ **VOLUME**  
 - adjusts the volume level.
 - sets the hours and minutes for the clock and timer.
- ⑯ **MP3 PLAYER IN**
 - 3.5mm audio input jack.
- ⑰ **Tape Deck Operation**
 - RECORD**  starts recording.
 - PLAY**  starts playback.
 - REW**  / **F.FWD**  fast rewinds/forwards the tape.
 - STOP-OPEN**   stops the tape; opens the tape compartment.
 - PAUSE**  pauses recording or playback.
- ⑱ **ALBUM +/-**
 - selects an album.
- ⑲ **MODE**
 - selects different play modes: e.g. REPEAT or SHUFFLE (random order)
- ⑳ **TIMER/SLEEP**
 - activates/deactivates the timer
 - activates/deactivates or selects the sleep time.
 - views the remaining sleep time.
- ㉑ **MUTE**
 - switches playback sound off and on.
- ㉒ **◀◀/▶▶**
 - skips to the beginning of a current track/previous/ next track (title).
 - (press and hold) fast searches back and forward within a track/disc
- ㉓ **DSC (Digital Sound Control)**
 - selects sound characteristics: OPTIMAL, JAZZ, ROCK or TECHNO.
- ㉔ **◀/▶**
 - skips to the beginning of a current track/previous/next track (title).

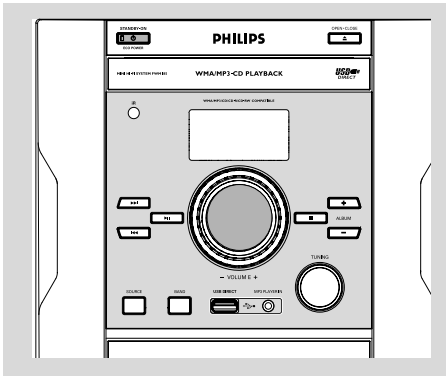

IMPORTANT:
Before you operate the system, complete the preparation procedures.

Switching the system on

- Press **STANDBY-ON** ϕ .
→ The system will switch to the last selected source.
- **To switch the system to standby mode**
Press **STANDBY-ON** ϕ .
→ The volume level (up to a maximum volume level of 15), interactive sound settings, last selected source and tuner presets will be retained in the player's memory.

Power-saving automatic standby

The power-saving feature automatically switches to standby 30 minutes after CD playback has ended and no control is operated.

Adjusting volume and sound

- 1 Adjust the **VOLUME** control knob or press **VOLUME** $\blacktriangle/\blacktriangledown$ on the remote control to increase or decrease volume.
→ Display shows the volume level *VOL* and a number from 0-40.

- 2 Press **DBB** to switch bass enhancement on or off.

→ Display shows: **DBB** if the DBB is activated.

- 3 Press **DSC** on the remote control repeatedly to select the desired sound effect: OPTIMAL, JAZZ, ROCK or TECHNO.

→ The selected DSC is shown.

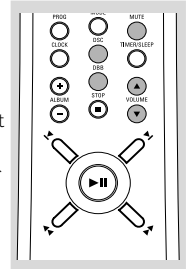

- 4 Press **MUTE** on the remote control to stop sound playback instantly.
→ Playback will continue without sound and the display shows **MUTE**.

- To start sound playback you can:
 - press **MUTE** again;
 - adjust the volume controls.

CD/MP3/WMA Operation

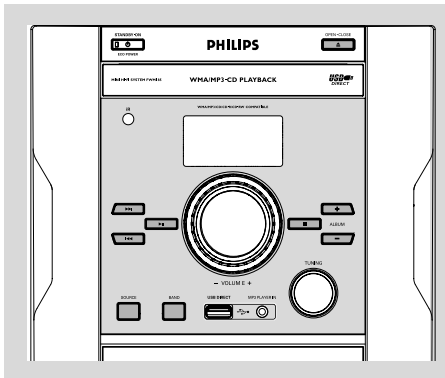

IMPORTANT:

The lens of the CD player should never be touched.

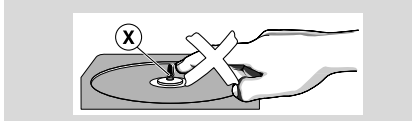

Playing a disc

This CD player plays Audio Discs including CD-Recordables, CD-Rewritables and MP3 CD.

- CD-ROM, CD-I, CDV, VCD, DVD or computer CDs, however, are not possible.
- 1 Press **SOURCE** once or more to select **CD**.
 - 2 Press **OPEN/CLOSE** on the system to open the CD compartment.
→ *OPEN* is displayed when you open the CD compartment.
 - 3 Insert a disc with the printed side facing up and press **OPEN/CLOSE** to close the CD door.
→ *READ* is displayed as the CD player scans the contents of a disc, and then the total number of tracks and playing time (or the total number of albums and tracks for MP3 disc) are shown.
 - 4 Press **▶▶** to start playback.
→ The current track number and elapsed playing time of the track are displayed during disc playback.

- 5 To pause playback press **▶▶**. Press **▶▶** again to resume play.

→ The display freezes and the elapsed playing time flashes when playback is interrupted.

- 6 To stop disc playback, press **STOP**.

Note: CD playback will also stop when;

– the CD door is opened.

– the disc has reached the end.

– you select another source: **TAPE, TUNER, USB or MP3 IN**.

– you select standby.

Selecting a different track

- Press **◀◀ / ▶▶** (**◀ / ▶** on the remote) once or repeatedly until the desired track number appears in the display.
- Press **▶▶** to start playback.

Finding a passage within a track

- 1 Press and hold down **◀◀ / ▶▶** (**◀▶▶** on the remote).
→ The disc is played at high speed and low volume.
- 2 When you find the passage you want, release **◀◀ / ▶▶** (**◀▶▶** on the remote).
→ Normal playback continues.

Playing an MP3/WMA disc

- 1 Load an MP3/WMA disc.
→ The disc reading time may exceed 10 seconds due to the large number of songs compiled into one disc.
→ "xx xx" is displayed. xx is the current album number and xx is the current track number.
- 2 Press **ALBUM+/-** to select a desired album.
- 3 Press **◀◀ / ▶▶** (**◀ / ▶** on the remote) to select a desired track.
→ The album number will change accordingly as you reach the first track of an album by pressing **◀◀** (**◀** on the remote) or the last track of an album by pressing **▶▶** (**▶** on the remote).
- 4 Press **▶▶** to start playback.

Discs for playback

This system can playback all digital audio CD, finalised digital audio CD-Recordable (CDR) discs and finalised digital audio CD-Rewritable (CDRW) discs.

MP3-CDs (CD-ROMs with MP3 tracks)



Supported MP3 disc formats:

- ISO9660, Joliet, UDF 1.5
- Maximum title number: 511 (depending on filename length)
- Maximum album number: 99
- Supported sampling frequencies: 32 kHz, 44.1 kHz, 48 kHz
- Supported Bit-rates: 32~256 (kbps), variable bitrates

Different play modes: SHUFFLE and REPEAT

You can select and change the various play modes before or during playback.

REPEAT plays the current track continuously

REPEAT ALL ... repeats the entire disc/programme

SHUF tracks of the entire disc are played in random order

- 1 To select your play mode, press **MODE** on the remote control before or during playback until the display shows the desired function.
 - 2 Press **▶||** to start playback if in the STOP position.
 - 3 To return to normal playback, press **MODE** on the remote control until the various SHUFFLE/REPEAT modes are no longer displayed.
- You can also press **STOP ■** to cancel your play mode.

Programming track numbers

Programme in the STOP position to select and store your disc tracks in the desired sequence. If you like, store any track more than once. Up to 20 tracks can be stored in the memory.

- 1 In the STOP position, press **PROG** on the remote control to enter the programming mode.
- 2 Use **◀◀ / ▶▶** (**◀ / ▶** on the remote) to select your desired track number.
 - For MP3/WMA disc, press **ALBUM+/-** and **◀◀ / ▶▶** (**◀ / ▶** on the remote) to select the desired album and title for programming.
→ The selected track number and **PROG** flash on the display panel.
- 3 Press **PROG** on the remote control to confirm the track number to be stored.
- 4 Repeat steps **2-3** to select and store all desired tracks.
- 5 To start playback of your disc programme, press **▶||**

Note:

– If you wish, you can add further tracks to your current program. Make sure you are in the STOP position, and that you have not exceeded 20 tracks.

Erasing the programme

You can erase the programme by:

- pressing **STOP ■** once in the STOP mode;
- pressing **STOP ■** twice during playback;
- opening the CD compartment;
- selecting another sound source
→ **PROG** disappears from the display.

Radio Reception

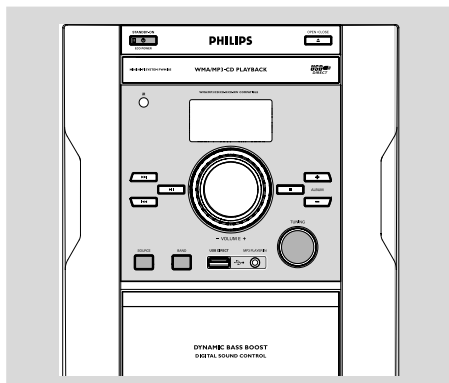

Tuning to radio stations

- 1 Press **SOURCE** once or more to select **TUNER**.
- 2 Press **BAND** once or more to select desired waveband: MW, FM MONO or FM ST (stereo).
- 3 Adjust the **TUNING** control knob to tune to a desired radio frequency.

Note:

– The system is equipped with an external MW antenna and a fixed FM antenna. For optimal MW reception, adjust the position of the MW loop antenna until the strongest signal is found. For optimal FM reception, fully extend and adjust the position of the FM antenna until the strongest signal is found.

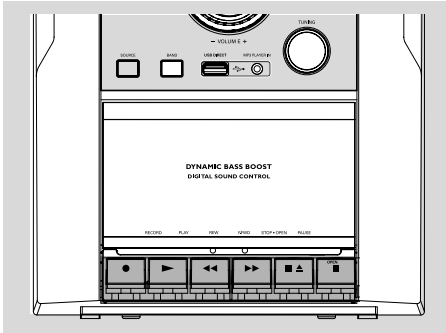

IMPORTANT!

- Before playing a tape, check and tighten slack tape with a pencil. Slack tape may get jammed or may burst in the mechanism.
- C-120 tape is extremely thin and is easily deformed or damaged. It is not recommended for use in this system.
- Store the tapes at room temperature and do not put them too close to a magnetic field (for example, a transformer, TV or speaker).

Tape playback

- 1 Press **SOURCE** once or more to select **TAPE**.
→ Display: shows **TAPE** throughout tape operation.
- 2 Press **STOP•OPEN** ■ ▲ to open the tape door.
- 3 Insert a recorded tape and close the tape door.
→ Load the tape with the open side downward and the full spool to the left.
- 4 Press **PLAY** ► to start playback.
- 5 To pause, press **PAUSE** II. Press **PAUSE** II again to resume.
- 6 Press **REW** ◀◀ or **F.FWD** ▶▶ to fast wind tape in either direction.
- 7 To stop the tape, press **STOP•OPEN** ■ ▲.

Notes:

- During playback, the keys are automatically released at the end of a tape. To switch off the set, press **STANDBY-ON** ○.
- During fast forwarding/rewinding, the keys will not be released at the end of a tape. To stop fast winding, press **STOP•OPEN** ■▲.

General information on recording

- Recording is permissible insofar as copyright or other rights of third parties are not infringed.
- For recording, use only **NORMAL** (IEC type I) tapes on which the tabs have not yet been broken. This deck is not suited for recording on **METAL** (IEC IV) type tapes.
- The best recording level is set automatically. Altering the **VOLUME** or **DBB** controls will not affect the recording in progress.
- The recording sound quality might differ depending on the quality of your recording source and the recording tape.
- At the very beginning and end of the tape, no recording will take place during the 7 seconds when the leader tape passes the recorder heads.
- To protect a tape from accidental erasure, have the tape in front of you and break out the left tab. Recording on this side is no longer possible. If, however, you wish to record over this side again, cover the tabs with a piece of adhesive tape.

Synchro start CD recording

- 1 Press **SOURCE** once or more to select **CD**.
- 2 Insert a disc and if desired, programme track numbers.
- 3 Press **STOP•OPEN** ■ ▲ to open the tape door.
- 4 Insert a suitable tape into the deck and close the tape door.
- 5 Press **RECORD** ● to start recording.
→ Playing of the CD programme starts automatically from the beginning of the CD after 7 seconds. It is not necessary to start the CD player separately.

Tape Operation / Recording

To select and record a particular passage within a CD track:

- Press and hold down on **REW ◀◀** or **F.FWD ▶▶**. Release the control when you recognize the passage you want.
 - To interrupt CD playback press **▶II**.
 - Recording starts from this exact point in the track when you press **RECORD ●**.
- 6 To pause, press **PAUSE II**. Press **PAUSE II** again to resume.
 - 7 To stop recording, press **STOP•OPEN ■ ▲**.

Recording from the radio

- 1 Tune to the desired radio station (see Tuning to radio stations).
- 2 Press **STOP•OPEN ■ ▲** to open the tape door:
- 3 Insert a suitable tape into the deck and close the tape door:
- 4 Press **RECORD ●** to start recording.
- 5 To pause, press **PAUSE II**. Press **PAUSE II** again to resume.
- 6 To stop recording, press **STOP•OPEN ■ ▲**.

Recording from external sources

- 1 Connect a USB mass storage device or external equipment (see External sources).
- 2 Press **SOURCE** to select the source.
- 3 Start playback of the selected source.
- 4 Insert a suitable tape into the deck and close the tape door.
- 5 Press **RECORD ●** to start recording.
- 6 To pause, press **PAUSE II**. Press **PAUSE II** again to resume.
- 7 To stop recording, press **STOP•OPEN ■ ▲**.

Using a USB mass storage device

By connecting a USB mass storage device to the Hi-Fi system, you can enjoy the device's stored music through the powerful speakers of Hi-Fi system.

Compatible USB mass storage devices

With the Hi-Fi system, you can use:

- USB flash memory (USB 2.0 or USB1.1)
- USB flash players (USB 2.0 or USB1.1)
- memory cards (requires an additional card reader to work with this Hi-Fi system)

Note:

– *In some USB flash players (or memory devices), the stored contents are recorded using copyright protection technology. Such protected contents will be unplayable on any other devices (such as this Hi-Fi system).*

– *Compatibility of the USB connection on this product:*

a) This product supports most USB Mass storage devices (MSD) that are compliant to the USB MSD standards.

i) Most common Mass storage class devices are flash drives, memory sticks, jump drives and etc.

ii) If you see a "Disc Drive" show up on your computer after you plugged the mass storage device into your computer, most likely it is MSD compliant and it will work with this product.

b) If your Mass storage device required a battery/ power source. Please make sure you have a fresh battery in it or charge the USB device first and then plug it into the product again.

– *Supported Music type:*

a) This device only supports unprotected music with the following file extension:

.mp3

.wma

b) Music bought from on-line music stores are not supported because they are secured by Digital Rights Management protection (DRM).

c) File name extensions that end with the following are not supported:

.wav; .m4a; .m4p; .mp4; .aac and etc.

– *No Direct connection can be made from Computer USB port to the product even you have either or both mp3 or wma files in your computer.*

Supported formats:

- USB or memory file format FAT12, FAT16, FAT32 (sector size: 512 - 65,536 bytes)
- MP3 bit rate (data rate): 32-320 Kbps and variable bit rate
- WMA v9 or earlier
- Directory nesting up to a maximum of 8 levels
- Number of albums/ folders: maximum 99
- Number of tracks/titles: maximum 400
- ID3 tag v2.0 or later
- File name in Unicode UTF8 (maximum length: 128 bytes)

The system will not play or support the following:

- Empty albums: an empty album is an album that does not contain MP3/WMA files, and will not be shown in the display.
- Non-supported file formats are skipped. This means that e.g.: Word documents .doc or MP3 files with extension .dlf are ignored and will not be played.
- AAC, WAV, PCM audio files
- DRM protected WMA files
- WMA files in Lossless format

How to transfer music files from PC to a USB mass storage device

By dragging and dropping music files, you can easily transfer your favorite music from PC to a USB mass storage device.

For the flash player, you can also use its music management software for the music transfer.

However, those WMA files may be unplayable for compatibility reasons.

External Sources

How to organize your MP3/WMA files on the USB mass storage device

This Hi-Fi system will browse the MP3/WMA files in the folders/sub-folders/titles order.

Example:

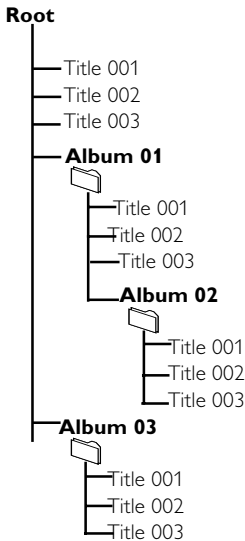

Organize your MP3/WMA files in different folders or subfolders as required.

Notes:

- If you have not organized MP3/WMA files into any albums on your disc, an album "00" will be automatically assigned for all those files.
- Make sure that the file names of MP3 files end with `.mp3` and the file names of WMA files end with `.wma`.
- For DRM protected WMA files, use Windows Media Player 10 (or later) for conversion. Visit www.microsoft.com for details about Windows Media Player and WM DRM (Windows Media Digital Rights Management).

Playing a USB mass storage device

- 1 Connect a USB device properly (See Optional connection).
- 2 Press **SOURCE** once or more to select **USB**.
→ **NO TRACK** appears if no audio file is found in the USB device.

- 3 Play the USB's audio files as you do with the albums/tracks on a CD (See CD/MP3/WMA Operations).

Notes:

- For compatibility reasons, the album/track information may differ from what it is displayed through flash players' music management software.
- File names or ID3 tags will be displayed as — if they are not in English.

Connecting external equipment

- 1 Connect the audio out terminal of the portable device (i.e. iPod or MP3 player) to the **MP3 PLAYER IN** terminal of your system.
- 2 Press **SOURCE** once or more to select **MP3 IN**.
→ "MP3 IN" is displayed.

Note:

- All the sound control features (DSC or DBB, for example) are available for selection.
- Refer to the operating instructions for the connected equipment for details.

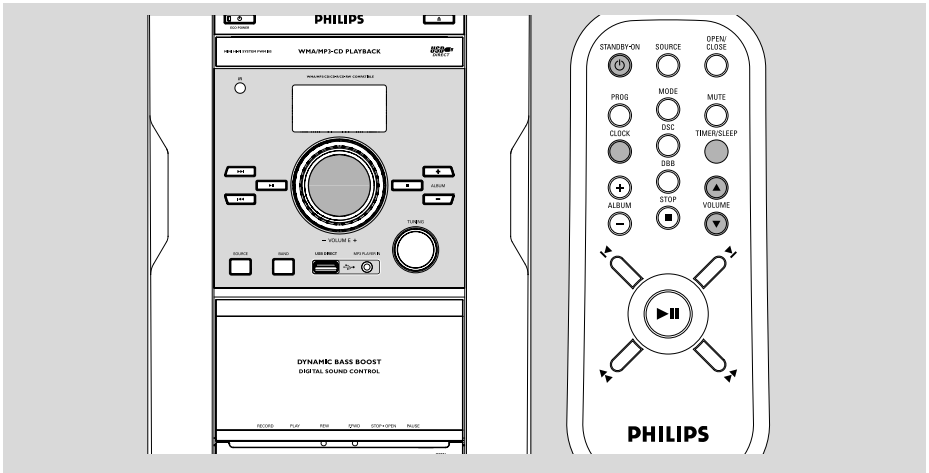

Setting the clock

- 1 In standby mode, press and hold **CLOCK**.
→ The clock digits for the hours flash.
- 2 Adjust the VOLUME control knob or press **VOLUME ▲/▼** on the remote control to set the hours.
- 3 Press **CLOCK**.
→ The clock digits for the minutes flash.
- 4 Adjust the VOLUME control knob or press **VOLUME ▲/▼** on the remote control to set the minutes.
- 5 Press **CLOCK** to confirm the time.

Note:

– If the clock has not been set, 0:00 will be displayed.

Setting the sleep timer

The sleep timer enables the system to switch off by itself after a set period of time.

- 1 In active mode, press **TIMER/SLEEP** on the remote control repeatedly until the desired timer option appears.
→ Selections are as follows (time in minutes):
SLP OFF → SLP 120 → SLP 90 → SLP 60
→ SLP 45 → SLP 30 → SLP 15 → SLP OFF
→ Display shows "S" if activated, and disappears if deactivated.
- 2 To cancel the sleep function, either press **TIMER/SLEEP** on the remote control once or more until "SLP OFF" appears, or press **STANDBY-ON** to switch to standby mode.

To check the remaining length of time after sleep timer is activated

- Press **TIMER/SLEEP** once.

Clock/Timer

Setting the timer

- The system can switch on to CD, TUNER, or USB mode automatically at a preset time, serving as an alarm to wake you up.

IMPORTANT!

- **Before setting the timer, ensure that the clock is set correctly.**
- **The timer will always be switched on after it has been set.**
- **The timer will not start if a recording is in progress.**
- **The volume of the timer will increase gradually from the minimum level to the last tuned volume level (If the last tuned volume level is less than 15, it will increase gradually from the minimum level to 15).**

- 1 In standby mode, press **TIMER/SLEEP**.
→ The clock digits for the hours flash.
- 2 Press **SOURCE** once or more to select the desired source.
 - Before setting timer, make sure the music source has been prepared.
 - CD** – Load the disc.
 - TUNER** – tune to the desired radio station.
 - USB** – connect a suitable USB mass storage device.
- 3 Adjust the VOLUME control knob or press **VOLUME ▲/▼** on the remote control to set the hours.
- 4 Press **TIMER/SLEEP** again.
→ The clock digits for the minutes flash.
- 5 Adjust the VOLUME control knob or press **VOLUME ▲/▼** on the remote control to set the minutes.
- 6 Press **TIMER/SLEEP** to confirm the time.
→ The timer is now activated and display shows 

To deactivate the timer,

- Press **TIMER/SLEEP** in standby mode.
→  disappears if the timer is deactivated.

Notes:

- *When the preset time is reached and the CD/USB is not available, Tuner will be selected automatically.*
- *During timer setting, if no button is pressed within 90 seconds, the system will exit timer setting mode automatically.*

AMPLIFIER

1 KHz
 (Low channel - both channels driven)
 30 W per channel (8 Ω)
 10 KHz
 (High channel - both channels driven)
 30 W per channel (8 Ω)
 Total output power 120 W
 Signal-to-noise ratio ≥ 62 dBA (IEC)
 Frequency response 63 – 16000 Hz, ± 3 dB

CD PLAYER

Frequency range 63 – 16000 Hz
 Signal-to-noise ratio 65 dBA

TUNER

FM wave range 87.5 – 108 MHz
 MW wave range 531 – 1602 kHz

TAPE DECK

Frequency response
 Normal tape (type I) 125 – 8000 Hz (8 dB)
 Signal-to-noise ratio
 Normal tape (type I) 35 dBA
 Wow and flutter ≤ 0.4% DIN

USB PLAYER

USB 12Mb/s, V1.1
 support MP3 and WMA files
 Number of albums/folders maximum 99
 Number of tracks/titles maximum 400

SPEAKERS

2-way Bass Reflex System
 Impedance 8 Ω
 Woofer 1×10 cm
 Tweeter 1×5 cm
 Dimensions (w x h x d) 21.5×34.9×17.5 (cm)

GENERAL

AC Power 220 – 230 V / 50 Hz
 Dimensions (w x h x d) 22×29.2×27.2 (cm)
 Weight (with/without speakers)
 approx. 8.9 / 4.2 kg

Specifications and external appearance are subject to change without notice.

Maintenance

Cleaning the Cabinet

- Use a soft cloth slightly moistened with a mild detergent solution. Do not use a solution containing alcohol, spirits, ammonia or abrasives.

Cleaning Discs

- When a disc becomes dirty, clean it with a cleaning cloth. Wipe the disc from the centre out.
- Do not use solvents such as benzene, thinner, commercially available cleaners, or antistatic spray intended for analogue records.

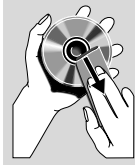

Cleaning the disc lens

- After prolonged use, dirt or dust may accumulate at the disc lens. To ensure good playback quality, clean the disc lens with Philips CD Lens Cleaner or any commercially available cleaner. Follow the instructions supplied with cleaner.

Cleaning the Heads and the Tape Paths

- To ensure good recording and playback quality, clean the heads (A), the capstan(s) (B), and pressure roller(s) (C) after every 50 hours of tape operation.
- Use a cotton swab slightly moistened with cleaning fluid or alcohol.
- You can also clean the heads by playing a cleaning tape once.

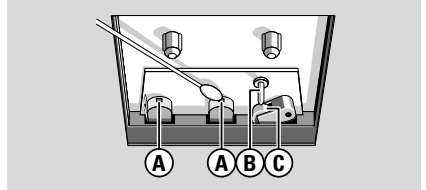

Demagnetising the heads

- Use a demagnetising tape available at your dealer.

WARNING

Under no circumstances should you try to repair the system yourself, as this will invalidate the warranty. Do not open the system as there is a risk of electric shock.

If a fault occurs, first check the points listed below before taking the system for repair. If you are unable to remedy a problem by following these hints, consult your dealer or service centre.

Problem

Solution

CD OPERATION

"No disc" is displayed.

- Insert a disc.
- Check if the disc is inserted upside down.
- Wait until the moisture condensation at the lens has cleared.
- Replace or clean the disc, see "Maintenance".
- Use a finalised CD-RW, CD-R or MP3 CD.

RADIO RECEPTION

Radio reception is poor.

- Increase the distance between the Micro HiFi System and your TV or VCR.

TAPE OPERATION / RECORDING

Recording or playback cannot be made.

- Clean deck parts, see "Maintenance".
- Use only normal (IEC I) tape for recording.
- Apply a piece of adhesive tape over the missing tab space.

GENERAL

The system does not react when buttons are pressed.

- Remove and reconnect the AC power plug and switch on the system again.

Sound cannot be heard or is of poor quality.

- Adjust the volume.
- Check that the speakers are connected correctly.
- Check if the stripped speaker wire is clamped.

The left and right sound outputs are reversed.

- Check the speaker connections and location.

Troubleshooting

The remote control does not function

- Reduce the distance between the remote control and the system.
- Insert the batteries with their polarities (+/- signs) aligned as indicated.
- Replace the batteries.
- Point the remote control directly toward IR sensor on the front of the system.

The timer is not working.

- Set the clock correctly.
- Press **TIMER/SLEEP** in standby mode to switch on the timer:
- If a recording is in progress, stop the recording.

The Clock/Timer setting is erased.

- Power has been interrupted or the power cord has been disconnected. Reset the clock/timer.
-

AUSTRALIA - Philips Manufacturers Warranty for Australia only

These warranty conditions are valid for the following consumer electronics products: Colour Televisions, Projection TV, Plasma & LCD TV, Video Cassette Recorders, DVD Recorders & Players, DVD Players, DVD Recorders, DVD Recorders with HDD, Audio Systems, Home Theatre systems, Digital Set Top Box & Portable Audio products.

The benefits given to the purchaser by this warranty are in addition to all other rights and remedies which the purchaser has in respect of the product under the Trade Practices Act or other Commonwealth or State Law.

Philips Consumer Electronics warrants its products to the purchaser as follows and subject to the stated conditions.

1 Year Free Repair Service - at Philips ASC

Colour Television, Plasma Television, LCD Television, Projection Television, DVDR/VCR Combo, DVD Recorders with Hard Drive, LCD Projectors, Wireless Audio Systems, Audio Systems, Home Theatre Systems & Digital Set-Top-Box.

1 Year Free Replacement – at your Retailer

Portable Audio, MP3 Infotainment products, Video Cassette recorders, DVD Player, DVD/VCR Combo Player; DVD Recorder without HDD & Portable DVD/ LCD players.

Conditions of Repair Warranty

1. All claims for warranty service should be made to your nearest Philips Authorised Service Centre or the Philips Technology Care Centre. Reasonable evidence of date of purchase must be provided.
2. This warranty extends only to defects in material or workmanship occurring under normal use of the product when operated in accordance with the instructions.
3. If a replacement product is supplied under the repair policy it is warranted for the remainder of the warranty of the original purchased product only.
4. Home service is provided only within the normal service area of one of our recommended Authorised Service Centres (ASC). It will be provided for television receivers only with a screen side of 67cms or above (product includes CRT, LCD TV, PTV, and Plasma TV). Televisions with screen side less than 67cms and all other products types are to be taken or sent by the consumer to the workshop of your nearest Authorised Service Centre, at the Consumer's expense.
5. This Manufacturers Warranty is limited to 3 months for the above listed Consumer Electronics products if used in commercial applications.
6. Philips may, at its discretion choose to replace rather than repair any product covered by this warranty.
7. Product accessories are covered by the same warranty period. Please contact the Philips Technology Care Centre for free replacement of faulty accessories.

8. This Manufacturers Warranty is neither transferable nor valid in countries other than Australia.

This warranty does not cover:

- a) Mileage or travel outside the normal service area covered by selected Authorised Service Centre.
- b) Service costs arising from failure to correctly adjust the controls of the product or to observe the instructions, or inspections that reveal that the product is in normal working order.
- c) Product failures caused by misuse, neglect, accidental breakage, transit damage, inexpert repairs or modification by un-authorised persons, external fires, lightning strikes, floods, vermin infestation or liquid spillage.
- d) Cleaning of video or audio heads.
- e) Inadequate receiving antennae.
- f) Replacement of worn or used batteries or other consumables.
- g) Consumer products used in commercial applications (This warranty is limited to 3 months only).
- h) Second hand products.

The conditions contained in this warranty card replace and override the provision of the Philips World-Wide Guarantee for products purchased in Australia and used in Australia.

Service is provided through more than 100 accredited Authorised Service Centres throughout Australia. For direct contact with the nearest recommended Authorised Service Centre in capital & regional cities/towns

Authorised Service Centre Network

1300 361 392

Customer support is provided in Australia by our trained call centre staff. For assistance with product features and specifications, please call

Technology Care Centre

1300 363 391

Please record the following information for your records and keep in a safe place. We recommend retaining your purchase receipt to assist with any warranty claim.

Model number:.....

Serial number:.....

Date of purchase:.....

Retailer:.....

Philips Consumer Electronics

a division of **Philips Electronics Australia Limited**
ABN 24 008 445 743,

Warranty valid for all new products purchased after **1st January 2007**

NEW ZEALAND - Guarantee and Service for New Zealand

Thank-you for purchasing this quality Philips product.

Philips New Zealand Ltd guarantees this product against defective components and faulty workmanship for a period of 12 months. Any defect in materials or workmanship occurring within 12 months from the date of purchase subject to the following conditions will be rectified free of charge by the retailer from whom this product was purchased.

Conditions

- 1.** The product must have been purchased in New Zealand. As proof of purchase, retain the original sales docket indicating the date of purchase.
- 2.** The guarantee applies only to faults caused by defective components, or faulty workmanship on the part of the manufacturer.
- 3.** The guarantee does not cover failures caused by misuse, neglect, normal wear and tear, accidental breakage, use on the incorrect voltage, use contrary to operating instructions, or unauthorised modification to the product or repair by an unauthorised technician.
- 4.** Reasonable evidence (in the form of a sales docket) must be supplied to indicate that the product was purchased no more than 12 months prior to the date of your claim.
- 5.** In the event of a failure, Philips shall be under no liability for any injury, or any loss or damage caused to property or products other than the product under guarantee.

This guarantee does not prejudice your rights under common law and statute, and is in addition to the normal responsibilities of the retailer and Philips.

How to claim

Should your Philips product fail within the guarantee period, please return it to the retailer from whom it was purchased. In most cases the retailer will be able to satisfactorily repair or replace the product.

However, should the retailer not be able to conclude the matter satisfactorily, or if you have other difficulties claiming under this guarantee, please contact

The Guarantee Controller

Philips New Zealand Ltd.

✉ **P.O. Box 41.021**

Auckland

☎ **(09) 84 94 160**

fax ☎ **(09) 84 97 858**

Meet Philips at the Internet
<http://www.philips.com>

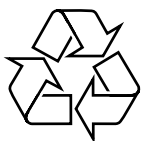

FWM185

