

Always there to help you

Register your product and get support at
www.philips.com/support



FX70



User manual

PHILIPS

Contents

1 Important	2
Safety	2
Notice	3

2 Your Mini Hi-Fi System	5
Introduction	5
What's in the box	5
Overview of the main unit	6
Overview of the remote control	7

3 Get started	9
Connect antennas	9
Connect speakers	9
Connect power	10
Prepare the remote control	10
Install radio stations automatically	10
Set clock	10
Turn on	11

4 Play	12
Play from a Bluetooth-enabled device	12
Play a disc	13
Play from USB	14

5 Listen to an external device	15
Listen to an MP3 player	15
Listen to an external audio device with RCA connectors	15

6 Play options	16
Repeat and shuffle play	16
Program tracks	16
Display play information	16

7 Adjust volume level and sound effect	17
Adjust volume level	17
Mute sound	17
Boost sound power	17
Select a preset sound effect	17
Enhance bass	17

8 Listen to radio	18
Tune to a radio station	18
Program radio stations automatically	18
Program radio stations manually	18
Select a preset radio station	18
Change AM tuning grid	18

9 USB record	19
Record to USB	19
Record CDDA contents to USB at any playback time	19

10 Other features	20
Set the alarm timer	20
Set the sleep timer	20
Restore default settings	20

11 Product information	21
Specifications	21
USB playability information	22
Supported MP3 disc formats	22
Maintenance	23

12 Troubleshooting	24
---------------------------	-----------

1 Important

Safety

Know these safety symbols



This 'bolt of lightning' indicates uninsulated material within your unit may cause an electrical shock. For the safety of everyone in your household, please do not remove product covering.

The 'exclamation mark' calls attention to features for which you should read the enclosed literature closely to prevent operating and maintenance problems.

WARNING: To reduce the risk of fire or electric shock, this apparatus should not be exposed to rain or moisture and objects filled with liquids, such as vases, should not be placed on this apparatus.

CAUTION: To prevent electric shock, match wide blade of plug to wide slot, and fully insert the plug.

Important Safety Instructions

- ① Read these instructions.
 - ② Keep these instructions.
 - ③ Heed all warnings.
 - ④ Follow all instructions.
 - ⑤ Do not use this apparatus near water.
 - ⑥ Clean only with dry cloth.
 - ⑦ Do not block any ventilation openings. Install in accordance with the manufacturer's instructions.
 - ⑧ Do not install near any heat sources such as radiators, heat registers, stoves, or other apparatus (including amplifiers) that produce heat.
 - ⑨ Protect the power cord from being walked on or pinched, particularly at plugs, convenience receptacles, and the point where they exit from the apparatus.
 - ⑩ Only use attachments/accessories specified by the manufacturer.
 - ⑪ Use only with the cart, stand, tripod, bracket, or table specified by the manufacturer or sold with the apparatus. When a cart is used, use caution when moving the cart/apparatus combination to avoid injury from tip-over.
- 
- ⑫ Unplug this apparatus during lightning storms or when unused for long periods of time.
 - ⑬ Refer all servicing to qualified service personnel. Servicing is required when the apparatus has been damaged in any way, such as power-supply cord or plug is damaged, liquid has been spilled or objects have fallen into the apparatus, the apparatus has been exposed to rain or moisture, does not operate normally, or has been dropped.
 - ⑭ Battery usage **CAUTION** – To prevent battery leakage which may result in bodily injury, property damage, or damage to the unit:
 - Install all batteries correctly, + and - as marked on the unit.
 - Do not mix batteries (old and new or carbon and alkaline, etc.).
 - Remove batteries when the unit is not used for a long time.

- 15 Apparatus shall not be exposed to dripping or splashing.
- 16 Do not place any sources of danger on the apparatus (e.g. liquid filled objects, lighted candles).
- 17 Where the MAINS plug or an appliance coupler is used as the disconnect device, the disconnect device shall remain readily operable.

Risk of overheating! Never install this apparatus in a confined space. Always leave a space of at least four inches around this apparatus for ventilation. Ensure curtains or other objects never cover the ventilation slots on this apparatus.



Warning

- Never remove the casing of this unit.
- Never lubricate any part of this unit.
- Place this unit on a flat, hard and stable surface.
- Never place this unit on other electrical equipment.
- Only use this unit indoors. Keep this unit away from water; moisture and liquid-filled objects.
- Keep this unit away from direct sunlight, naked flames or heat.



Caution

- Never look into the laser beam inside the product.

Notice

Any changes or modifications made to this device that are not expressly approved by Gibson Innovations may void the user's authority to operate the equipment.

Specifications are subject to change without notice. Gibson Innovations reserves the right to change products at any time without being obliged to adjust earlier supplies accordingly.

Your product is designed and manufactured with high quality materials and components, which can be recycled and reused.

Never dispose of your product with other household waste. Please inform yourself about the local rules on the separate collection of electrical and electronic products and batteries. The correct disposal of these products helps prevent potentially negative consequences on the environment and human health.

Your product contains batteries, which cannot be disposed of with normal household waste.

Please inform yourself about the local rules on separate collection of batteries. The correct disposal of batteries helps prevent potentially negative consequences on the environment and human health.

Please visit www.recycle.philips.com for additional information on a recycling center in your area.



Be responsible
Respect copyrights

The making of unauthorized copies of copy-protected material, including computer programs, files, broadcasts and sound recordings, may be an infringement of copyrights and constitute a criminal offence. This equipment should not be used for such purposes.

Environmental information

All unnecessary packaging has been omitted. We have tried to make the packaging easy to separate into three materials: cardboard (box), polystyrene foam (buffer) and polyethylene (bags, protective foam sheet.)

Your system consists of materials which can be recycled and reused if disassembled by a specialized company. Please observe the local regulations regarding the disposal of packaging materials, exhausted batteries and old equipment.



The Bluetooth® word mark and logos are registered trademarks owned by Bluetooth SIG, Inc. and any use of such marks by Gibson Innovations Limited is under license. Other trademarks and trade names are those of their respective owners.

Other trademarks and trade names are those of their respective owners.



The N Mark is a trademark or registered trademark of NFC Forum, Inc. in the United States and in other countries.

This apparatus includes this label:



Note

- The type plate is located on the back of the unit.

2 Your Mini Hi-Fi System

Congratulations on your purchase, and welcome to Philips! To fully benefit from the support that Philips offers, register your product at www.philips.com/welcome.

Introduction

With this Hi-Fi system, you can:

- enjoy audio from discs, USB storage devices, Bluetooth enabled devices, or other external devices
- listen to FM radio stations

To enrich sound, this Hi-Fi system offers you these sound effects:

- Max Sound for instant power boost
- Bass boost
- EQ (equalizer) settings
- The unit supports these media formats:



What's in the box

Check and identify the contents of your package:

- Main unit
- 2 x loudspeakers
- 1 x subwoofer
- 1 x plug adapter
- Remote control (with battery)
- AM and FM antennas
- Printed materials

Overview of the main unit

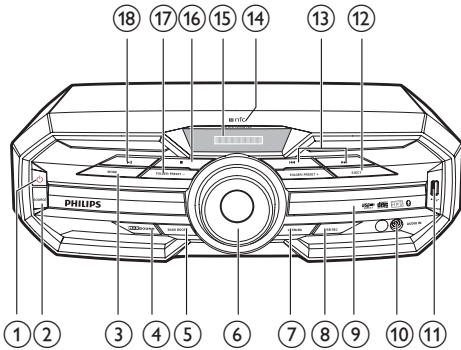

- ① Turn on the unit.
 - Switch to normal standby or Eco Power standby mode.
- ② **SOURCE**
 - Select a sound source: DISC, BT, USB, FM, AM, AUDIO IN, or AUX IN.
- ③ **MODE**
 - Select repeat or random play.
- ④ **MAX SOUND**
 - Turn on or off instant power boost for sound.
- ⑤ **BASS BOOST**
 - Select a level of dynamic bass enhancement.
- ⑥ **Volume knob**
 - Adjust speaker volume.
- ⑦ **LATIN EQ**
 - Select a preset sound equalizer setting.
- ⑧ **USB REC**
 - Record to a USB mass storage device.
- ⑨ **Disc compartment door**

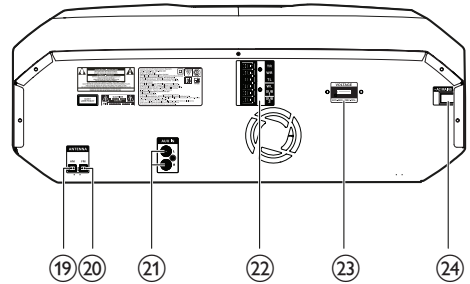

- ⑩ **AUDIO IN**
 - Connect an external audio device through a 3.5mm audio cable (not supplied).
- ⑪ Connect a USB mass storage device.
- ⑫ **EJECT**
 - Open or close the disc compartment.
- ⑬
 - Skip to the previous/next track.
 - Tune to a radio station.
- ⑭ **NFC area**
 - Touch with an NFC compatible device to set up Bluetooth connection automatically.
- ⑮ **Display panel**
 - Show the current status.
- ⑯ Stop play or erase a program.
- ⑰ **FOLDER/PRESET +/-**
 - For MP3/WMA tracks, skip to the previous/next album/folder.
 - Select a preset radio station.

- 18 **▶||**
 - Start, pause, or resume play.
- 19 **ANTENNA (AM)**
 - Connect the supplied AM antenna.
- 20 **ANTENNA (FM)**
 - Connect the supplied FM antenna.
- 21 **AUX IN (L/R)**
 - Connect an external audio device through RCA (red/white) audio cables.
- 22 **Speaker connection sockets**
 - Connect the supplied loudspeakers.
- 23 **Voltage selector**
 - Select the voltage that matches your local mains.
- 24 **AC power connection**

Overview of the remote control

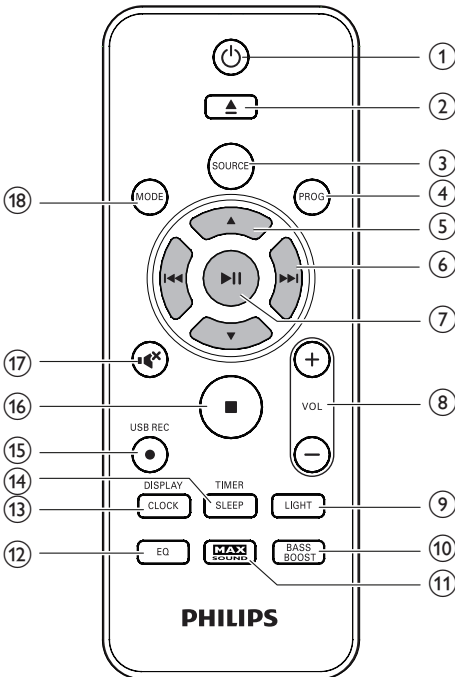

- 1 **⏻**
 - Turn on the unit.
 - Switch to normal standby or Eco Power standby mode.
- 2 **▲**
 - Open or close the disc compartment.
- 3 **SOURCE**
 - Select a sound source: DISC, USB, TUNER, AUDIO IN, AUX IN or BT.
- 4 **PROG**
 - Program tracks.
 - Program radio stations.
- 5 **▲ / ▼**
 - Skip to the previous/next album.
 - Select a preset radio station.
- 6 **◀◀ / ▶▶**
 - Skip to the previous/next track.
 - Search within a track/disc/USB.
 - Tune to a radio station.
- 7 **▶||**
 - Start, pause, or resume play.
 - Confirm selection.
- 8 **VOL +/-**
 - Adjust speaker volume.
- 9 **LIGHT**
 - Turn on/off the decoration light effect of the main set.
- 10 **BASS BOOST**
 - Turn on or off dynamic bass enhancement.
- 11 **MAX SOUND**
 - Turn on or off instant power boost for sound.
- 12 **EQ**
 - Select a preset sound equalizer setting.

⑬ CLOCK/DISPLAY

- Set the clock.
- Select display information.

⑭ SLEEP/TIMER

- Set the sleep timer.
- Set the alarm timer.
- Turn on or off sleep/alarm timer.

⑮ USB REC

- Record to a USB mass storage device.

⑯ ■

- Stop play or erase a program.

⑰ 🔇

- Mute or restore sound output.

⑰ MODE

- Select repeat or random play.

3 Get started

Caution

- Use of controls or adjustments or performance of procedures other than herein may result in hazardous laser exposure or other unsafe operation.

Always follow the instructions in this chapter in sequence.

If you contact Philips, you will be asked for the model and serial number of this apparatus. The model number and serial number are on the back of the apparatus. Write the numbers here:

Model No. _____

Serial No. _____

Connect antennas

- For better radio reception, connect the supplied FM and AM antennas to the ANTENNA (FM,AM) sockets on the back of the main unit respectively.

FM

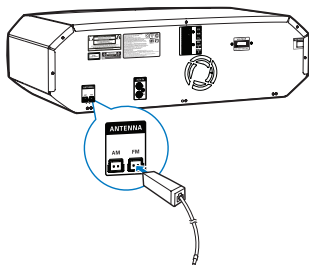

AM

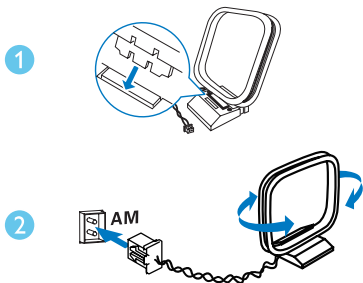

Connect speakers

Note

- For optimal sound, use the supplied speakers only.
- Connect only speakers with impedance that is the same or higher than the supplied speakers. Refer to the Specifications section of this manual.

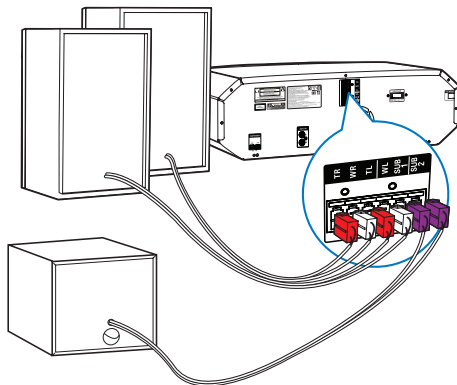

Note

- Make sure that the colors of the speaker wires and terminals are matched.

Insert the wire completely.

- Insert the right speaker wires to "R", left speaker wires to "L", and subwoofer wires to 'SUB'.

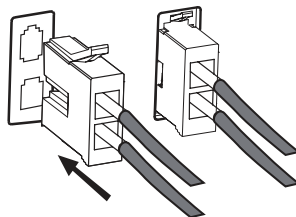

Connect power

! Caution

- Make sure that the power supply socket used can support at least 10A current loading.
- Before connecting the AC power cord, make sure that you have completed all the other connections.

- Connect the AC power cable to the wall socket.

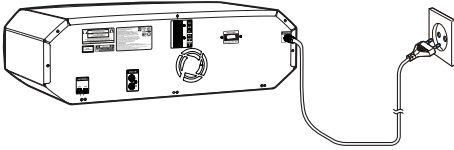

Prepare the remote control

≡ Note

- Risk of explosion! Keep batteries away from heat, sunshine or fire. Never discard batteries in fire.
- Danger of explosion if the battery is incorrectly replaced. Replace only with the same or equivalent type.

- 1 Open the battery compartment.
- 2 Insert one AAA battery with correct polarity (+/-) as indicated.
- 3 Close the battery compartment.

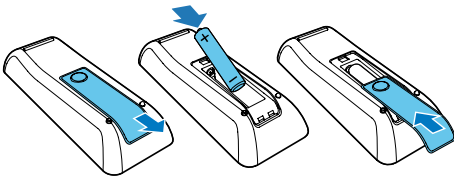

≡ Note

- If you are not going to use the remote control for a long time, remove the battery.
- Batteries contain chemical substances, so they should be disposed of properly.

Install radio stations automatically

When you connect power and no radio stations are stored, the unit automatically begins to store radio stations.

- 1 Connect the unit to power supply.
↳ [AUTO FM INSTALL - PRESS PLAY-STOP CANCEL] (auto FM install - press PLAY to start - press STOP to cancel) is displayed.
- 2 Press ►|| to start installation.
↳ [AUTO] (auto) is displayed.
↳ The unit automatically stores radio stations with sufficient signal strength.
↳ When all the available radio stations are stored, the first preset radio station is broadcast automatically.

Set clock

- 1 In standby mode, hold **CLOCK** for more than two seconds to activate clock setting.
↳ 'CLOCK SET' is displayed. Then, the 12 hour or 24 hour format is displayed.
- 2 Press ▲/▼ repeatedly to select 12 hour or 24 hour format.
- 3 Press **CLOCK** to confirm.
↳ The hour digits are displayed and begin to blink.
- 4 Press ▲/▼ repeatedly to set the hour, then press **CLOCK** to confirm.
↳ The minute digits are displayed and begin to blink.
- 5 Press ▲/▼ repeatedly to set the minute, then press **CLOCK** to confirm the set clock.

Tip

- During setting, you can press  to exit clock setting without saving the earlier operation.
- During setting, if no action is taken within 90 seconds, the device exits clock setting automatically without saving the earlier operation.
- During play or in ECO Power standby mode, you press **CLOCK** to view the set clock.

Turn on

- Press .
 - ↳ The unit switches to the last selected source.

Switch to standby mode

- Press  again to switch the unit to normal standby mode.
 - ↳ The clock (if set) is displayed on the panel.

To switch to ECO Power standby mode:

- Press and hold  for more than two seconds.
 - ↳ The display panel is dimmed.
 - ↳ The ECO power indicator on the left of the display panel lights up red.

Note

- The unit switches to Eco Power standby mode after 10 minutes in standby mode.

To switch between normal standby mode and ECO Power standby mode:

- Press and hold  for more than two seconds.

4 Play

Play from a Bluetooth-enabled device

Note

- The effective operation range between the unit and your Bluetooth enabled device is approximately 10 meters (30 feet).
- Any obstacle between the unit and the Bluetooth enabled device can reduce the operational range.
- Compatibility with all Bluetooth devices is not guaranteed.
- The unit can memorize up to 4 previously connected Bluetooth devices.

To enjoy music through the unit wirelessly, you need to pair your Bluetooth enabled device with the unit.

Choose your best Bluetooth pairing method based on the preconditions listed below.

Precondition	Pairing method
Your Bluetooth device supports both NFC (Near Field Communication) and A2DP (Advanced Audio Distribution Profile).	Choose Option 1 (recommended) or Option 2.
Your Bluetooth device only supports A2DP (Advanced Audio Distribution Profile).	Choose Option 2.

- Before pairing and connection, you need to:
 - ① **press SOURCE repeatedly to select the Bluetooth source.**
 - ↳ [BT] (Bluetooth) flashes on the screen.
 - ② **enable the Bluetooth feature on your external device.**

Pair and connect

Option 1: Pair and connect through NFC

Near Field Communication (NFC) is a technology that enables short-range wireless communication between various NFC compatible devices, such as mobile phones and IC tags.

With the NFC function, data communication can be achieved easily just by touching the relevant symbol or designated location on NFC compatible devices.

Note

- Compatibility with all NFC devices is not guaranteed.

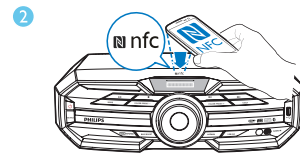

- 1 Enable the NFC feature on your Bluetooth enabled device (see the user manual of the device for details).
- 2 Touch the NFC area of the external device with the NFC area on the top of the unit until you hear a beep.
 - ↳ After successful pairing and connection, 'BT CONNECTED' (BT connected) scrolls on the screen once.

Option 2: Pair and connect manually

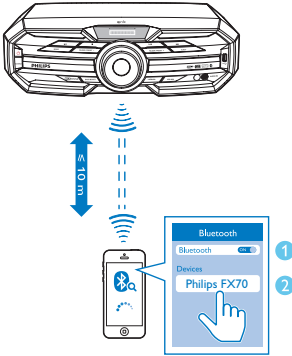

- 1 On the Bluetooth enabled device, search for Bluetooth devices that can be paired (see the user manual of the device).
- 2 Select 'Philips FX70' on your Bluetooth enabled device and if necessary input '0000' as the pairing password.
↳ After successful pairing and connection, 'BT CONNECTED' (BT connected) scrolls on the screen once.

Stream music through Bluetooth

- Play audio on the Bluetooth device connected to the unit.
↳ Audio streams from your Bluetooth enabled device to the unit.

Tip

- If the Bluetooth enabled device also supports AVRCP (Audio Video Remote Control Profile), you can use some basic operation buttons of the unit (such as the play/pause, stop and previous/next buttons) to control music play.

To disconnect the Bluetooth-enabled device:

- Press and hold ►|| on the remote control for three seconds.
- Deactivate Bluetooth on your device; or
- Move the device beyond the communication range.

To clear Bluetooth pairing history:

- Press and hold both ■ on the remote control for three seconds.

Play a disc

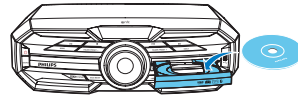

- 1 Press **SOURCE** repeatedly to select the disc source.
- 2 Press ▲ to open the disc compartment.
- 3 Load a disc onto the disc tray, with the printed side facing up.
- 4 Press ▲ again to close the disc compartment.
↳ Play starts automatically.
 - To pause/resume play, press ►||.
 - To stop play, press ■.
 - To select another track, press ◀◀ / ▶▶.
 - To select an album, press ▲ / ▼.
 - To search within a track, press and hold ◀◀ / ▶▶, then release to resume normal play.

Play from USB

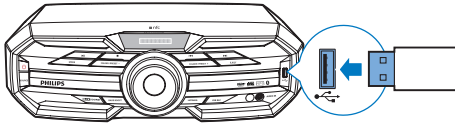

Note

- Make sure that the USB device contains playable audio contents in supported formats. The NTFS file format is not supported.
- A USB hub is not supported.
- Some card readers may not be supported.

- 1 Plug the USB device into the  socket on the main unit.
- 2 Press **SOURCE** repeatedly to select the USB source.
- 3 Press **▲** / **▼** to select a folder.
- 4 Press **◀◀** / **▶▶** to select an audio file.
- 5 If play does not start automatically, press **▶||**.
 - To pause/resume play, press **▶||**.
 - To stop play, press **■**.
 - To search within an audio file, press and hold **◀◀** / **▶▶**, then release to resume normal play.

5 Listen to an external device

You can listen to an external audio device through the speakers of this unit.

Listen to an MP3 player

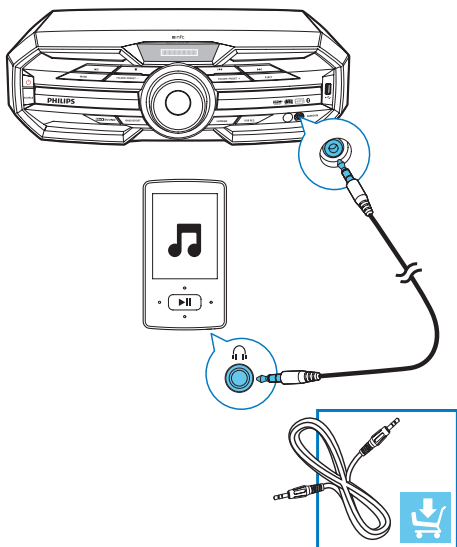

- 1 Press **SOURCE** repeatedly to select the **AUDIO IN** source.
- 2 Connect a 3.5mm audio cable (not supplied) to:
 - the 3.5mm audio input socket on the front of the unit.
 - the headphone socket on the MP3 player.
- 3 Start play on the MP3 player (see the player user manual).

Listen to an external audio device with RCA connectors

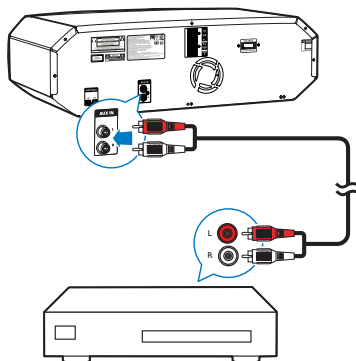

- 1 Press **SOURCE** repeatedly to select the **AUX IN** source.
- 2 Connect a pair of RCA audio cables (red/white; not supplied) to:
 - the **AUX IN (L/R)** socket on the back of the unit.
 - the RCA audio output sockets (red/white) on the external device.
- 3 Start play on the external device (see the device user manual).

6 Play options

Display play information

- During play, press **CLOCK/DISPLAY** repeatedly to select different play information.

Repeat and shuffle play

- During disc play, press **MODE** repeatedly to select:
 - **REPEAT ONE**: the current track is played repeatedly.
 - **REPEAT ALL**: all tracks are played repeatedly.
 - **SHUFFLE**: all tracks in the current folder are played randomly.
 - **REPEAT OFF**: normal play is resumed.



Tip

- Shuffle play cannot be selected when you play programmed tracks.

Program tracks

You can program a maximum of 20 tracks.

- 1 In DISC/USB mode, press **■** to stop play, then press **PROG** to activate track programming.
↳ [PROGRAM] (program) is displayed.
- 2 For MP3 tracks, press **▲** / **▼** to select an album/folder.
- 3 Press **◀◀** / **▶▶** to select a track number, then press **PROG** to confirm.
- 4 Repeat steps 2 to 3 to select and store all tracks to program.
- 5 Press **▶||** to play the programmed tracks.
 - To erase the program, when play is stopped, press **■**.

7 Adjust volume level and sound effect

Note

- MAX sound and bass boost cannot be activated at the same time.

Adjust volume level

Caution

- For your hearing health and being consideration of other people, it is not recommended to listen at high volume levels for a long time.
- During play, press **VOL +/-** to increase/decrease the volume level.

Mute sound

- During play, press **M** to mute/unmute sound.

Boost sound power

The MAX sound feature gives an instant boost to the sound power .

- Press **MAX SOUND** to turn on or off the instant power boost.

Select a preset sound effect

- During play, press **EQ** repeatedly to select special sound effects:
 - **[ROCK]** (rock)
 - **[POP]** (pop)
 - **[HIP-HOP]** (hip-hop)
 - **[REGUETON]** (regueton)
 - **[PARTY]** (party)

Enhance bass

You can manually select the level of dynamic bass boost (DBB) that best suits your listening environment.

- During play, press **BASS BOOST** repeatedly to select:
 - DBB 1
 - DBB 2
 - DBB 3
 - DBB off
- ↳ If DBB is activated, **DBB** is displayed.

8 Listen to radio

Tune to a radio station

- 1 Press **SOURCE** repeatedly to select FM or AM.
- 2 Press and hold **◀▶** for more than two seconds.
 - ↳ [SEARCH] (search) is displayed.
 - ↳ The radio tunes to a station with strong reception automatically.
- 3 Repeat step 2 to tune to more stations.
 - To tune to a weak station, press **◀▶** repeatedly until you find optimal reception.

Program radio stations automatically

You can program a maximum of 20 FM and 10 AM preset radio stations.

- In tuner mode, press and hold **PROG** for more than two seconds to activate automatic programming.
 - ↳ [AUTO] (auto) is displayed.
 - ↳ All available stations are programmed in the order of waveband reception strength.
 - ↳ The first programmed radio station is broadcast automatically.

Program radio stations manually

You can program a maximum of 20 FM and 10 AM preset radio stations.

- 1 Tune to a radio station.
- 2 Press **PROG** to activate program mode.
- 3 Press **▲** / **▼** to allocate a number to this radio station, then press **PROG** to confirm.
- 4 Repeat the above steps to program other stations.

Tip

- To overwrite a programmed station, store another station in its place.

Select a preset radio station

- In tuner mode, press **▲** / **▼** to select a preset number.

Tip

- Position the antennas as far as possible from TV, or other radiation sources.
- For optimal reception, fully extend and adjust the position of the antennas.

Change AM tuning grid

In some countries, the AM radio frequency step between adjacent channels is 10 kHz (9 kHz in some areas).

- 1 Select the tuner source.
- 2 Press and hold **▶||** on the main unit for more than five seconds.
 - ↳ All preset stations are erased and need to be re-programmed.

9 USB record

Audio CD tracks and MP3 files are recorded in .mp3 format.

The first time you record to USB, a folder is automatically created in the USB device. Each time you record to USB, the recorded files are stored in a sub-folder. Files and sub-folders are named numerically in the order by which they are created.

Record to USB

- 1 Plug the USB device into the  socket on the unit.
- 2 Select the disc source and load a disc. You can select a track from which a recording starts.
- 3 Press **USB REC** to start recording.
 - You can press **USB REC** repeatedly to select:
 - (A) [REC ONE] (record one): the first/current track is recorded.
 - (B) [REC ALL] (record all): all tracks/the remaining tracks are recorded.
 - ↳ Disc play starts automatically from the beginning of the disc/the selected track, and the recording starts.
 - To stop recording, press **■**.

Note

- If the USB device does not have enough memory to store the audio files, a message about a full memory is displayed.

Record CDDA contents to USB at any playback time

Note

- Make sure that the USB storage device is connected to the main unit.

To record the CDDA content into a USB storage device at any playback time:

- 1 Press **USB REC** during CDDA playback.
↳ The recording starts.
- 2 Press **■** to stop recording.

Tip

- If the USB storage device does not have enough memory to store the audio files, a message about a full memory is displayed.
- Anytime recording is not available for MP3-CD discs.
- Anytime recording is not available for High speed recording.

10 Other features

Set the alarm timer

This unit can be used as an alarm clock. You can select disc, radio or USB as alarm source.

- 1 Make sure that you have set the clock correctly.
- 2 Press and hold **SLEEP/TIMER** for more than two seconds.
 - ↳ 'TIMER SET' is displayed. Then, a prompt to select the sound source is displayed.
- 3 Press **SOURCE** to select a source from DISC, USB and FM, then press **SLEEP/TIMER** to confirm.
 - ↳ In 12 hour format, AM or PM is displayed. In this case, press **▲ / ▼** to select AM or PM. Then the hour digits are displayed and begin to blink.
 - ↳ In 24 hour format, the hour digits are displayed and begin to blink.
- 4 Press **▲ / ▼** repeatedly to set the hour, then press **SLEEP/TIMER** to confirm.
 - ↳ The minute digits are displayed and begin to blink.
- 5 Press **▲ / ▼** repeatedly to set the minute, then press **SLEEP/TIMER** to confirm.
 - ↳ A prompt to select the volume level is displayed.
- 6 Press **VOL +/-** to select the desired volume level, then press **SLEEP/TIMER** to confirm.
 - ↳ The alarm timer is set and activated.

To deactivate or re-activate an alarm timer

- In standby mode, press **SLEEP/TIMER** repeatedly.
 - ↳ When the alarm timer is deactivated, 'TIMER OFF' is displayed.
 - ↳ When the alarm timer is re-activated, 'TIMER ON' is displayed.

Tip

- In BT, AUDIO IN or AUX IN mode, the alarm timer cannot be set.
- If the disc or USB source is selected but no audio file can be played, FM radio is activated automatically.

Set the sleep timer

This unit can switch to standby automatically after a set period of time.

- When the unit is turned on, press **SLEEP/TIMER** repeatedly to select a set period of time (in minutes).

To deactivate sleep timer

- Press **SLEEP/TIMER** repeatedly until [OFF] (off) is displayed.

Restore default settings

You can also restore the default settings of the unit.

- In any mode, press and hold both **▶||** and **PRESET** - on the front panel for more than five seconds.
 - ↳ After a while, 'RESET OK' is displayed. Then, the device reboots automatically.

11 Product information

Note

- Product information is subject to change without prior notice.

Specifications

Amplifier

Rated Output Power	1600W +/- 0.5 dB RMS
Total output power	1920W +/- 0.5 dB RMS
Frequency response	60Hz -20KHz, +/- 3dB
Signal-to- noise ratio	≥60 dBA
Audio in/AUX input	1V/2V RMS Rin≥22kΩ

Disc

Laser type	Semiconductor
Disc diameter	12cm/8cm
Support disc	CD-DA, CD-R, CD-RW, MP3-CD
Audio DAC	24Bits / 44.1kHz
Total harmonic distortion	<1% (1 kHz)
Frequency Response	60Hz - 20kHz (44.1kHz)
S/N Ratio	≥62dBA

Tuner

FM tuning range	FM: 87.5 - 108MHz AM: 531 - 1602kHz(9kHz); 530 - 1700kHz(10kHz)
Tuning grid	100kHz (FM), 9kHz/10kHz (AM)
Number of Presets	20 FM; 10 AM
Sensitivity	
- Mono, 26dB S/N Ratio	< 22 dBf
Search Selectivity	< 35 dBf
Total Harmonic Distortion	< 2%
Signal to Noise Ratio	> 50dB

Speakers

Speaker	3ohm
Impedance	
Speaker Driver	10" Subwoofer, 8" Woofer, 4" Mediant, 2" Tweeter
Sensitivity	SubWoofer: 85± 3dB/m/W L/R: 86± 3dB/m/W

General information-Specs

AC power	110V-127V/220V-240V~ /50-60 Hz
Operation power consumption	220 W
Standby power consumption	18 W
ECO power consumption	0.5 W
USB direct	Version 2.0HS, 5V 1A

Bluetooth	
Bluetooth® version	V4.0 EDR
Frequency band	2.402GHz ~ 2.480GHz ISM Band
Bluetooth Profile	A2DP, AVRCP1.4
Range	10m (free space)

Dimensions	
Main Unit (W x H x D)	467 x 140 x 320 mm
Speaker Box (W x H x D)	321 x 485 x 255 mm
Subwoofer (W x H x D)	370 x 409 x 320 mm

Weight	
Main Unit	4.4 kg
Speaker Box	8.5 kg each
Subwoofer	9.2 kg

- Number of albums/ folders: maximum 99
- Number of tracks/titles: maximum 999
- ID3 tag v2.0 or later
- File name in Unicode UTF8 (maximum length: 128 bytes)

Unsupported formats:

- Empty albums: an empty album is an album that does not contain MP3/WMA files, and is not be shown in the display.
- Unsupported file formats are skipped. For example, Word documents (.doc) or MP3 files with extension .dlf are ignored and not played.
- AAC, WAV, PCM audio files
- DRM protected WMA files (.wav, .m4a, .m4p, .mp4, .aac)
- WMA files in Lossless format

USB playability information

Compatible USB devices:

- USB flash memory (USB 2.0 or USB 1.1)
- USB flash players (USB 2.0 or USB 1.1)
- memory cards (requires an additional card reader to work with this unit)

Supported formats:

- USB or memory file format FAT16, FAT32 (sector size: 512 bytes)
- MP3 bit rate (data rate): 32-320 Kbps and variable bit rate
- Directory nesting up to a maximum of 7 levels

Supported MP3 disc formats

- ISO9660, Joliet
- Maximum title number: 999 (depending on file name length)
- Maximum album number: 99
- Supported sampling frequencies: 32 kHz, 44.1kHz, 48 kHz
- Supported Bit-rates: 32-320 (kbps), variable bit rates
- ID3 tag v2.0 or later
- Directory nesting up to a maximum of 7 levels

Maintenance

Clean the cabinet

- Use a soft cloth slightly moistened with a mild detergent solution. Do not use a solution containing alcohol, spirits, ammonia or abrasives.

Clean discs

- When a disc becomes dirty, clean it with a cleaning cloth. Wipe the disc from the centre out.

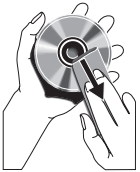

- Do not use solvents such as benzene, thinner, commercially available cleaners, or antistatic spray intended for analogue records.

Clean the disc lens

- After prolonged use, dirt or dust may accumulate at the disc lens. To ensure good play quality, clean the disc lens with Philips CD lens cleaner or any commercially available cleaner. Follow the instructions supplied with cleaner.

12 Troubleshooting



Warning

- Never remove the casing of this apparatus.

To keep the warranty valid, never try to repair the system yourself.

If you encounter problems when using this apparatus, check the following points before requesting service. If the problem remains unsolved, go to the Philips web site (www.philips.com/welcome). When you contact Philips, ensure that the apparatus is nearby and the model number and serial number are available.

No power

- Ensure that the AC power plug of the unit is connected properly.
- Ensure that there is power at the AC outlet.
- To save power, the unit switches to standby automatically 10 minutes after a play reaches the end and no control is operated.

No sound or poor sound

- Adjust the volume.
- Check that the speakers are connected correctly.
- Check if the stripped speaker wires are clamped.

Left and right sound outputs reversed

- Check the speaker connections and location.

No response from the unit

- Disconnect and reconnect the AC power plug, then turn on the unit again.

Remote control does not work

- Before you press any function button, first select the correct source with the remote control instead of the main unit.

- Reduce the distance between the remote control and the unit.
- Insert the battery with their polarities (+/- signs) aligned as indicated.
- Replace the battery.
- Aim the remote control directly at the sensor on the front of the main unit.

No disc detected

- Insert a disc.
- Check if the disc is inserted upside down.
- Wait until the moisture condensation at the lens has cleared.
- Replace or clean the disc.
- Use a finalized CD or correct format disc.

Cannot display some files in USB device

- The number of folders or files in the USB device has exceeded a certain limit. This phenomenon is not a malfunction.
- The formats of these files are not supported.

USB device not supported

- The USB device is incompatible with the unit. Try another one.

Poor radio reception

- Increase the distance between the unit and your TV or VCR.
- If the signal is too weak, adjust the antenna or connect an external antenna for better reception.

Clock/timer setting erased

- Power has been interrupted or the power cord has been disconnected.
- Reset the clock/timer.

Timer does not work

- Set the clock correctly.
- Switch on the timer.

Music playback is unavailable on the system even after successful Bluetooth connection.

- The device cannot be used with the unit to play music.

The audio quality is poor after connection with a Bluetooth-enabled device.

- The Bluetooth reception is poor. Move the device closer to the unit or remove any obstacle between the device and the unit.

Cannot connect with the unit.

- The device does not support the profiles required for the unit.
- The Bluetooth function of the device is not enabled. Refer to the user manual of the device for how to enable the function.
- The unit is not in pairing mode.
- The unit is already connected with another Bluetooth-enabled device. Disconnect that device or all other connected devices and then try again.

The paired mobile phone connects and disconnects constantly.

- The Bluetooth reception is poor. Move the mobile phone closer to the unit or remove any obstacle between the mobile phone and the unit.
- Some mobile phones may connect and disconnect constantly when you make or end calls. This does not indicate any malfunction of the unit.
- For some mobile phones, the Bluetooth connection may be deactivated automatically as a power-saving feature. This does not indicate any malfunction of the unit.



2015 © Gibson Innovations Limited. All rights reserved.

This product has been manufactured by, and is sold under the responsibility of Gibson Innovations Ltd., and Gibson Innovations Ltd. is the warrantor in relation to this product.

Philips and the Philips Shield Emblem are registered trademarks of Koninklijke Philips N.V. and are used under license from Koninklijke Philips N.V.

