

# Always there to help you

Register your product and get support at  
[www.philips.com/support](http://www.philips.com/support)



FXD18



# User manual

# PHILIPS



# Contents

---

<b>1 Important</b>	2
Safety	2
Notice	3

---

<b>2 Your DVD Mini Hi-Fi System</b>	6
Introduction	6
What's in the box	6
Overview of the main unit	7
Overview of the remote control	8

---

<b>3 Connect</b>	10
Place the unit	10
Connect speakers	10
Connect video cables	10
Optional connections	12
Connect power	13

---

<b>4 Get started</b>	14
Prepare the remote control	14
Turn on	14
Install radio stations automatically	14
Find the correct viewing channel	14
Select the correct TV system	15
Change system menu language	15

---

<b>5 Play</b>	16
Play from a Bluetooth-enabled device	16
Play a disc	17
Play from USB or recorded discs	18
Play a slideshow with background music	18
Play control	18
Enjoy karaoke	19
Adjust volume level and sound effect	20

---

<b>6 Listen to radio</b>	21
Tune to a radio station	21
Program radio stations automatically	21
Program radio stations manually	21
Select a preset radio station	21

---

<b>7 USB record</b>	22
---------------------	----

---

<b>8 Adjust settings</b>	23
General setup	23
Video setup	23
Audio setup	24
Preferences	25

---

<b>9 Product information</b>	27
Specifications	27
Supported disc formats	28
USB playability information	28

---

<b>10 Troubleshooting</b>	29
---------------------------	----

---

# 1 Important

## Safety

### Know these safety symbols



This 'bolt of lightning' indicates uninsulated material within your unit may cause an electrical shock. For the safety of everyone in your household, please do not remove product covering.

The 'exclamation mark' calls attention to features for which you should read the enclosed literature closely to prevent operating and maintenance problems.

**WARNING:** To reduce the risk of fire or electric shock, this apparatus should not be exposed to rain or moisture and objects filled with liquids, such as vases, should not be placed on this apparatus.

**CAUTION:** To prevent electric shock, match wide blade of plug to wide slot, and fully insert the plug.

### Important Safety Instructions

- 1 Read these instructions.
- 2 Keep these instructions.
- 3 Heed all warnings.
- 4 Follow all instructions.
- 5 Do not use this apparatus near water.
- 6 Clean only with dry cloth.

- 7 Do not block any ventilation openings. Install in accordance with the manufacturer's instructions.
- 8 Do not install near any heat sources such as radiators, heat registers, stoves, or other apparatus (including amplifiers) that produce heat.
- 9 Protect the power cord from being walked on or pinched, particularly at plugs, convenience receptacles, and the point where they exit from the apparatus.
- 10 Only use attachments/accessories specified by the manufacturer.
- 11 Use only with the cart, stand, tripod, bracket, or table specified by the manufacturer or sold with the apparatus. When a cart is used, use caution when moving the cart/apparatus combination to avoid injury from tip-over.



- 12 Unplug this apparatus during lightning storms or when unused for long periods of time.
- 13 Refer all servicing to qualified service personnel. Servicing is required when the apparatus has been damaged in any way, such as power-supply cord or plug is damaged, liquid has been spilled or objects have fallen into the apparatus, the apparatus has been exposed to rain or moisture, does not operate normally, or has been dropped.
- 14 Battery usage **CAUTION** – To prevent battery leakage which may result in bodily injury, property damage, or damage to the unit:
  - Install all batteries correctly, + and - as marked on the unit.

- Do not mix batteries (old and new or carbon and alkaline, etc.).
- Remove batteries when the unit is not used for a long time.

- ⑮ **Apparatus shall not be exposed to dripping or splashing.**
- ⑯ **Do not place any sources of danger on the apparatus (e.g. liquid filled objects, lighted candles).**
- ⑰ **Where the MAINS plug or an appliance coupler is used as the disconnect device, the disconnect device shall remain readily operable.**

Risk of overheating! Never install this apparatus in a confined space. Always leave a space of at least four inches around this apparatus for ventilation. Ensure curtains or other objects never cover the ventilation slots on this apparatus.



#### Caution

- Use of controls or adjustments or performance of procedures other than herein may result in hazardous radiation exposure or other unsafe operation.



#### Warning

- Never remove the casing of this unit.
- Never lubricate any part of this unit.
- Place this unit on a flat, hard and stable surface.
- Never place this unit on other electrical equipment.
- Only use this unit indoors. Keep this unit away from water; moisture and liquid-filled objects.
- Keep this unit away from direct sunlight, naked flames or heat.
- Never look into the laser beam inside the unit.

## Notice

# CE 0560

Hereby, WOOX Innovations declares that this product is in compliance with the essential requirements and other relevant provisions of Directive 1999/5/EC. You can find the Declaration of Conformity on [www.philips.com](http://www.philips.com)/support.

Any changes or modifications made to this device that are not expressly approved by WOOX Innovations may void the user's authority to operate the equipment.

Specifications are subject to change without notice. WOOX reserves the right to change products at any time without being obliged to adjust earlier supplies accordingly.

## Disposal of your old product and batteries

Your product is designed and manufactured with high quality materials and components, which can be recycled and reused.

Never dispose of your product with other household waste. Please inform yourself about the local rules on the separate collection of electrical and electronic products and batteries. The correct disposal of these products helps prevent potentially negative consequences on the environment and human health.

Your product contains batteries, which cannot be disposed of with normal household waste.

Please inform yourself about the local rules on separate collection of batteries. The correct disposal of batteries helps prevent potentially negative consequences on the environment and human health.

Please visit [www.recycle.philips.com](http://www.recycle.philips.com) for additional information on a recycling center in your area.

### Information about the use of batteries:

#### Caution

- Risk of leakage: Only use the specified type of batteries. Do not mix new and used batteries. Do not mix different brands of batteries. Observe correct polarity. Remove batteries from products that are not in use for a longer period of time. Store batteries in a dry place.
- Risk of injury: Wear gloves when handling leaking batteries. Keep batteries out of reach of children and pets.
- Risk of explosion: Do not short circuit batteries. Do not expose batteries to excessive heat. Do not throw batteries into the fire. Do not damage or disassemble batteries. Do not recharge non-rechargeable batteries.

### Environmental information

All unnecessary packaging has been omitted. We have tried to make the packaging easy to separate into three materials: cardboard (box), polystyrene foam (buffer) and polyethylene (bags, protective foam sheet.)

Your system consists of materials which can be recycled and reused if disassembled by a specialized company. Please observe the local regulations regarding the disposal of packaging materials, exhausted batteries and old equipment.

### Copyright notice

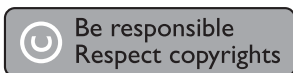

This item incorporates copy protection technology that is protected by U.S. patents and other intellectual property rights of Rovi Corporation. Reverse engineering and disassembly are prohibited.

### Trademark notice

Philips and the Philips' Shield Emblem are registered trademarks of Koninklijke Philips N.V. and are used by WOOX Innovations Limited under license from Koninklijke Philips N.V.™



Manufactured under license from Dolby Laboratories. Dolby and the double-D symbol are trademarks of Dolby Laboratories.



DivX ®, DivX Ultra ®, DivX Certified ® and associated logos are trademarks of Rovi Corporation or its subsidiaries and are used under license.

DivX Ultra ® Certified to play DivX ® video with advanced features and premium content.

ABOUT DIVX VIDEO: DivX ® is a digital video format created by DivX, LLC, a subsidiary of Rovi Corporation. This is an official DivX Certified ® device that plays DivX video. Visit [divx.com](http://divx.com) for more information and software tools to convert your files into DivX videos.

ABOUT DIVX VIDEO-ON-DEMAND: This DivX Certified ® device must be registered in order to play purchased DivX Video-on-Demand (VOD) movies. To obtain your registration code, locate the DivX VOD section in your device setup menu. Go to [vod.divx.com](http://vod.divx.com) for more information on how to complete your registration.



'DVD Video' is a trademark of DVD Format/ Logo Licensing Corporation.



HDMI, and HDMI logo, and High-Definition Multimedia Interface are trademarks or registered trademarks of HDMI licensing LLC in the United States and other countries.



The Bluetooth® word mark and logos are registered trademarks owned by Bluetooth SIG, Inc. and any use of such marks by WOOX Innovations is under license.

Other trademarks and trade names are those of their respective owners.



The N Mark is a trademark or registered trademark of NFC Forum, Inc. in the United States and in other countries.

This apparatus includes this label:



#### Note

- The type plate is located on the back of the unit.

## 2 Your DVD Mini Hi-Fi System

Congratulations on your purchase, and welcome to Philips! To fully benefit from the support that Philips offers, register your product at [www.philips.com/welcome](http://www.philips.com/welcome).

### Introduction

With this unit, you can:

- Watch video from DVD/VCD/SVCD or USB storage devices
- Enjoy audio from discs, USB storage devices, Bluetooth enabled devices, or other external devices
- View pictures from discs or USB storage devices
- Listen to FM radio

You can enrich sound output with these sound effects:

- Max Sound for instant power boost
- Bass boost
- EQ (equalizer) settings

The unit supports these media/disc formats:



You can play DVD discs marked with the following region code:

DVD region code	Countries
 	Asia Pacific

### What's in the box

Check and identify the contents of your package:

- Main unit
- 2 x speakers
- Remote control with battery
- Power cord
- FM antenna
- Printed materials



## Overview of the main unit

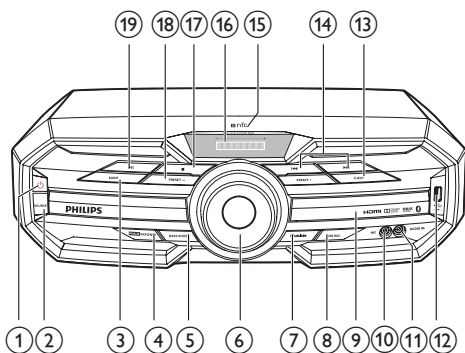

- ①
  - Turn on the unit or switch to standby mode.
- ② **SOURCE**
  - Select a sound source: DISC, USB, FM, AUDIO IN or BT.
- ③ **MODE**
  - Select repeat or shuffle play.
  - Access more play options while playing a disc or a USB storage device.
- ④ **MAX SOUND**
  - Turn on or off instant power boost for sound.
- ⑤ **BASS BOOST**
  - Select a level of dynamic bass enhancement.
- ⑥ **Volume knob**
  - Adjust speaker volume.
- ⑦ **EQUALIZER**
  - Select a preset sound equalizer setting.
- ⑧ **USB REC**
  - Go to the screen for USB recording.
- ⑨ **Disc compartment door**
- ⑩ **MIC**
  - Connect a microphone.

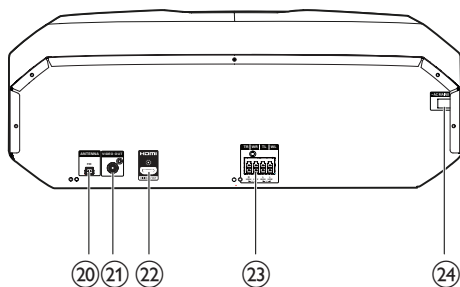

- ⑪ **AUDIO IN**
  - Connect an external audio device through a 3.5mm audio cable (not supplied).
- ⑫
  - Connect a USB mass storage device.
- ⑬ **EJECT**
  - Open or close the disc compartment.
- ⑭
  - Skip to the previous/next track, title, or chapter.
  - Tune to a radio station.
- ⑮ **NFC area**
  - Touch with an NFC compatible device to set up Bluetooth connection automatically.
- ⑯ **Display panel**
  - Show the current status.
- ⑰
  - Stop play or erase a program.
- ⑱ **PRESET +/-**
  - Select a preset radio station.
- ⑲
  - Start or pause play.
- ⑳ **ANTENNA (FM)**
  - Connect the supplied FM antenna.

- ②1 VIDEO OUT
  - Connect to the composite video input on the TV.
- ②2 HDMI
  - Connect to the HDMI input on the TV.
- ②3 Speaker connection sockets
  - Connect the supplied loudspeakers.
- ②4 AC power connection

## Overview of the remote control

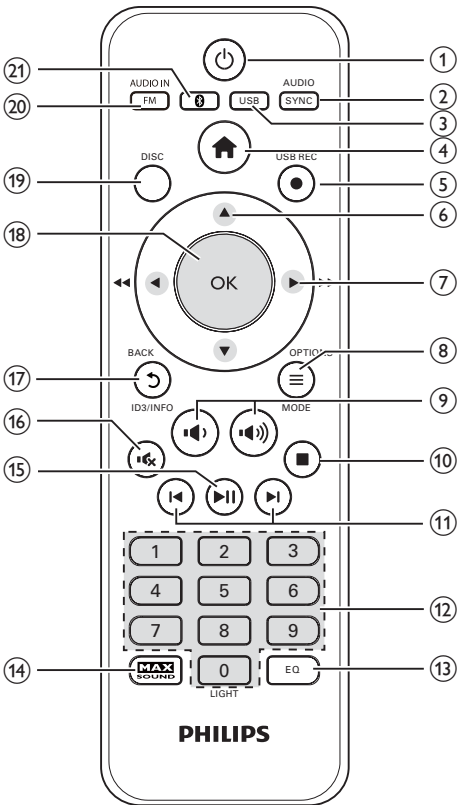

- ①
  - Turn on the unit or switch to standby mode.

- ② AUDIO SYNC
  - Select an audio language or channel.
  - Press and hold to access audio delay setting, then press navigation buttons (left/right) to delay the audio to match the video.
- ③ USB
  - Switch to the USB source.
- ④
  - In DISC/USB mode, access or exit the home menu.
- ⑤ USB REC ●
  - Go to the screen for USB recording.
- ⑥ ▲ / ▼
  - Navigate up/down in a menu.
  - Rotate a picture.
  - During video play, select a slow backward/forward mode.
  - In radio mode, select a preset radio station.
- ⑦ ◀ / ▶ (◀◀ / ▶▶)
  - Search in a track or disc.
  - Navigate left/right in a menu.
  - Tune to a radio station.
- ⑧ OPTIONS (MODE)
  - Access more play options while playing a disc or a USB storage device.
  - Select repeat or shuffle play.
- ⑨ /
  - Adjust speaker volume.
- ⑩
  - Stop play or erase a program.
- ⑪ /
  - Skip to the previous/next track, title, or chapter.
- ⑫ Numeric keypad
  - Select a title/chapter/track.
  - **0 LIGHT** (unavailable for this model): Turn on/off the decoration light effect of the main set.

- ⑬ **EQ**
  - Select a preset sound equalizer setting.
- ⑭ **MAX SOUND**
  - Turn on or off instant power boost for sound.
- ⑮ **▶||**
  - Start or pause play.
- ⑯ **🔇**
  - Mute or restore volume.
- ⑰ **↶ BACK (ID3/INFO)**
  - Return to the previous menu.
  - For discs, access the play options or display the current disc status.
  - For slideshow, display a thumbnail view of photo files.
  - For MP3 discs, display ID3 information if available.
- ⑱ **OK**
  - Confirm an operation or selection.
- ⑲ **DISC**
  - Select the disc source.
- ⑳ **FM/AUDIO IN**
  - Switch between the FM and AUDIO IN source.
- ㉑ **📶**
  - Select the Bluetooth source.

# 3 Connect

## Place the unit

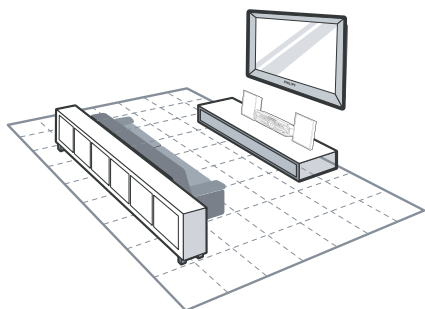

- 1 Place the unit near the TV.
- 2 Place the left and right speakers at equal distance from the TV and at an angle of approximately 45 degrees from the listening position.

### Note

- To avoid magnetic interference or unwanted noise, never place both the main set and speakers too close to any radiation devices.
- Place this unit on top of a table.
- Never place this unit in an enclosed cabinet.
- Place this unit near the AC outlet where the AC power plug can be easily reached.

## Connect speakers

### Note

- For optimal sound, use the supplied speakers only.
- Connect only speakers with impedance that is the same or higher than the supplied speakers. Refer to the Specifications section of this manual.

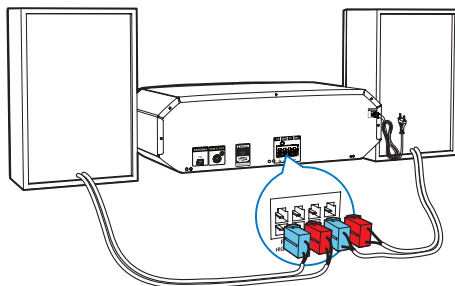

### Note

- Make sure that the colors of the speaker wires and terminals are matched.

Insert the wire completely.

- Insert the right speaker wires to "R", and left speaker wires to "L".

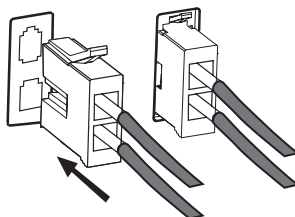

## Connect video cables

Select the best video connection that the TV can support.

- **Option 1:** Connect to the HDMI socket (for an HDMI, DVI or HDCP-compliant TV).
- **Option 2:** Connect to the composite video socket (for a standard TV).

## Option 1: Connect to the HDMI socket

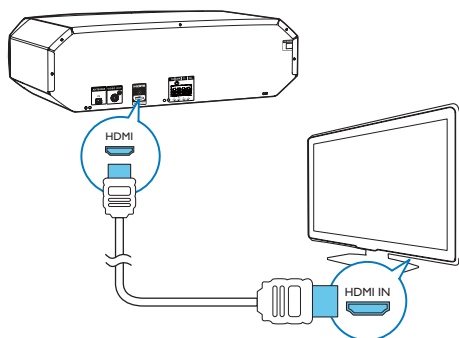

- 1 Connect an HDMI cable (not supplied) to:
  - the **HDMI** socket on the unit.
  - the HDMI input socket on the TV.

### Tip

- If the TV has a DVI connector only, connect via an HDMI/DVI adaptor. Connect an audio cable for sound output.
- If this product connects to a TV compatible with 1080p or 1080p/24Hz, we recommend HDMI category 2 cable, also known as High Speed HDMI cable, for optimal video and audio output.
- To play the digital video images of a DVD video via an HDMI connection, it is necessary that both this product and the display device (or an AV receiver/amplifier) support a copyright protection system called HDCP (high-bandwidth digital content protection system).
- This type of connection provides the best picture quality.

## Option 2: Connect to the composite video socket

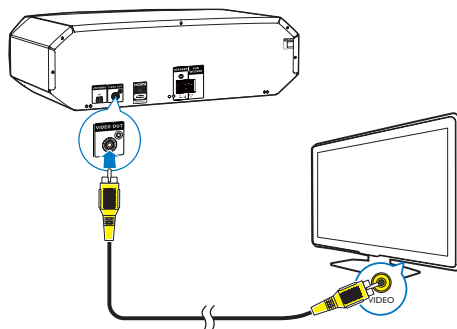

- Connect a composite video cable (not supplied) to:
  - the **VIDEO OUT** socket on the unit.
  - the VIDEO input socket on the TV.

### Tip

- The video input socket on the TV might be labeled as AV IN, VIDEO IN, COMPOSITE or BASEBAND.

## Optional connections

### Connect USB flash drive

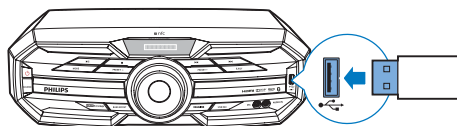

- Connect a USB storage device to the  socket on the front panel.

## Note

- This unit only supports play of MP3, DivX (Ultra) or JPEG files that are stored on a USB storage device.
- Press **USB** to access the content and play the files.

## Connect FM antenna

### Tip

- For optimal reception, fully extend and adjust the position of the antenna.
  - For better FM stereo reception, connect an outdoor FM antenna to the **FM ANTENNA** socket.
  - The unit does not support MW radio reception.
- Connect the supplied FM wire antenna to the **FM ANTENNA** socket on the back of the unit.

## FM

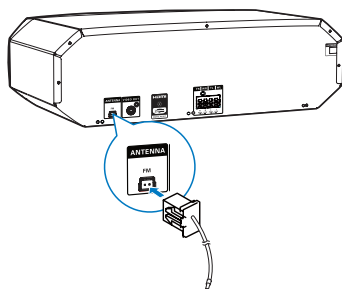

## Route audio from other devices

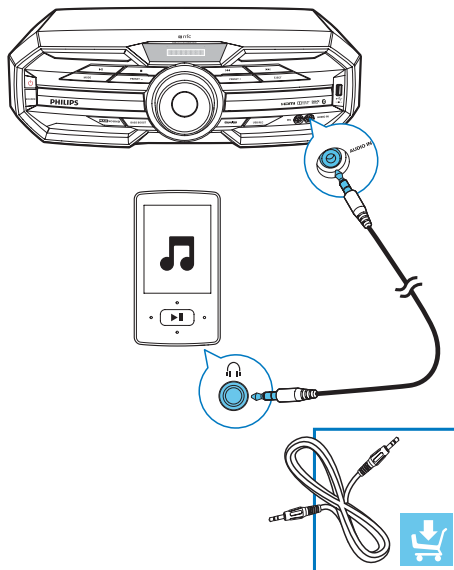

- Connect a 3.5mm audio cable (not supplied) to:
  - the 3.5mm audio input socket on the front of the unit.
  - the headphone socket on the MP3 player.

### Tip

- Press **FM/AUDIO IN** repeatedly to select the **AUDIO IN** source, then start play on the MP3 player (see the player user manual).

## Connect power

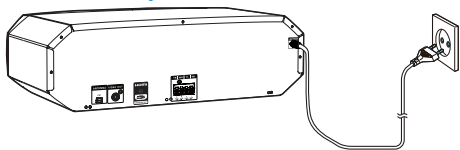

### Caution

- Risk of product damage! Make sure that the power supply voltage corresponds to the voltage printed on the back or the underside of the unit.
  - Before connecting the AC power cord, make sure that you have completed all other connections.
- 
- Connect the AC power cord to the socket on this unit.

## 4 Get started



### Caution

- Use of controls or adjustments or performance of procedures other than herein may result in hazardous radiation exposure or other unsafe operation.

Always follow the instructions in this chapter in sequence.

If you contact <brand>, you will be asked for the model and serial number of this apparatus. The model number and serial number are on the back of the apparatus. Write the numbers here:

Model No. \_\_\_\_\_

Serial No. \_\_\_\_\_

### Prepare the remote control

- 1 Press and push the battery compartment to slide it open (see "1" in the illustration).
- 2 Insert one AAA battery with correct polarity (+/-) as indicated.
- 3 Push and slide back the battery compartment (see "3" in the illustration).

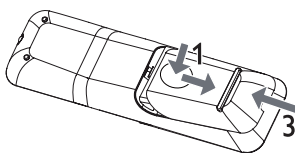

### Note

- The battery shall not be exposed to excessive heat such as sunshine, fire or the like.
- If you are not going to use the remote control for a long time, remove the battery.
- Batteries contain chemical substances, so they should be disposed of properly.

### Turn on

- Press  $\phi$ .
  - ↳ The unit switches to the last selected source.

### Switch to standby mode

- Press  $\phi$  again to switch the unit to standby mode.
  - ↳ The backlight on the display panel turns off.

### To switch to ECO Power standby mode:

- Press and hold  $\phi$  for more than two seconds.
  - ↳ The display panel is dimmed.
  - ↳ The ECO power indicator on the left of the display panel lights up red.



### Note

- The unit switches to Eco Power standby mode after 10 minutes in standby mode.

### To switch between normal standby mode and ECO Power standby mode:

- ↳ Press and hold  $\phi$  for more than two seconds.

### Install radio stations automatically

When you connect power and no radio stations are stored, the unit automatically begins to store radio stations.

- 1 Connect the unit to power supply.
  - ↳ [AUTO FM INSTALL - PRESS PLAY--STOP CANCEL] (auto FM install - press PLAY to start - press STOP to cancel) is displayed.



- 2 Press ►|| to start installation.
  - ↳ [AUTO] (auto) is displayed.
  - ↳ The unit automatically stores radio stations with sufficient signal strength.
  - ↳ When all the available radio stations are stored, the first preset radio station is broadcast automatically.

## Find the correct viewing channel

- 1 Press  $\phi$  to turn on the unit.
- 2 Press **DISC** to switch to disc mode.
- 3 Turn on the TV and switch to the correct video-in channel in one of the following ways:
  - Go to the lowest channel on your TV, then press the Channel Down button until you see the blue screen.
  - Press the source button repeatedly on the remote control of your TV.

### Tip

- The video-in channel is between the lowest and highest channels and may be called FRONT, A/V IN, VIDEO etc. See the TV user manual on how to select the correct input on the TV.

## Select the correct TV system

Change this setting if the video is not displayed correctly. By default, this setting matches the most common setting for TVs in your country.

- 1 Press  $\uparrow$ .
- 2 Select  $\ast$  [Setup] -> [Video] -> [TV System].
- 3 Select a setting and press **OK**.
  - [PAL]- For TV with PAL color system.
  - [Multi]- For TV that is compatible with both PAL and NTSC.
  - [NTSC]- For TV with NTSC color system.
- 4 To return to the previous menu, press  $\leftarrow$ .
- 5 To exit the menu, press  $\uparrow$ .

## Change system menu language

- 1 Press  $\uparrow$ .
- 2 Select  $\ast$  [Setup] -> [General] -> [OSD Language], and press **OK**.
- 3 Select a setting and then press **OK**.
- 4 To exit the menu, press  $\uparrow$ .

# 5 Play

## ! Caution

- Risk of damage to the unit! During play, never move the unit.

## Play from a Bluetooth-enabled device

### ☰ Note

- The effective operation range between the unit and your Bluetooth enabled device is approximately 10 meters (30 feet).
- Any obstacle between the unit and the Bluetooth enabled device can reduce the operational range.
- Compatibility with all Bluetooth devices is not guaranteed.
- The unit can memorize up to 4 previously connected Bluetooth devices.

To enjoy music through the unit wirelessly, you need to pair your Bluetooth enabled device with the unit.

Choose your best Bluetooth pairing method based on the preconditions listed below.

Precondition	Pairing method
Your Bluetooth device supports both NFC (Near Field Communication) and A2DP (Advanced Audio Distribution Profile).	Choose Option 1 (recommended) or Option 2.
Your Bluetooth device only supports A2DP (Advanced Audio Distribution Profile).	Choose Option 2.

- Before pairing and connection, you need to:

- ① **press  $\text{\textcircled{0}}$  to select the Bluetooth source.**  
↳ [BT] (Bluetooth) flashes on the screen.
- ② **enable the Bluetooth feature on your external device.**

## Pair and connect

### Option 1: Pair and connect through NFC

Near Field Communication (NFC) is a technology that enables short-range wireless communication between various NFC compatible devices, such as mobile phones and IC tags.

With the NFC function, data communication can be achieved easily just by touching the relevant symbol or designated location on NFC compatible devices.

### ☰ Note

- Compatibility with all NFC devices is not guaranteed.

1



2



- 1 Enable the NFC feature on your Bluetooth enabled device (see the user manual of the device for details).
- 2 Touch the NFC area of the external device with the NFC area on the top of the unit until you hear a beep.  
↳ After successful pairing and connection, 'BT CONNECTED' (BT connected) scrolls on the screen once.

## Option 2: Pair and connect manually

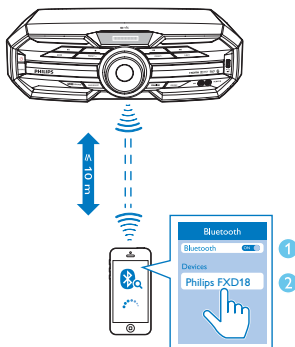

- 1 On the Bluetooth enabled device, search for Bluetooth devices that can be paired (see the user manual of the device).
- 2 Select 'Philips FXD18' on your Bluetooth enabled device and if necessary input '0000' as the pairing password.
  - ↳ After successful pairing and connection, 'BT CONNECTED' (BT connected) scrolls on the screen once.

## Stream music through Bluetooth

- Play audio on the Bluetooth device connected to the unit.
  - ↳ Audio streams from your Bluetooth enabled device to the unit.

### To disconnect the Bluetooth-enabled device:

- Press and hold ►|| on the remote control for three seconds.
- Deactivate Bluetooth on your device; or
- Move the device beyond the communication range.

### To clear Bluetooth pairing history:

- Press and hold both ■ on the remote control for three seconds.

## Play a disc

### ! Caution

- Never look at the laser beam inside the unit.
- Risk of product damage! Never play discs with accessories such as disc stabilizer rings or disc treatment sheets.
- Never put any objects other than discs into the disc compartment.

- 1 Press **DISC** to select the disc source.
- 2 Press **EJECT** on the front panel.
  - ↳ The disc tray opens.
- 3 Place a disc onto the tray and press **EJECT** again to close the disc tray.
  - ↳ Make sure that the label side faces up.
- 4 If play does not start automatically, select a title/chapter/track, then press ►|| to start play.
  - To stop play, press ■.
  - To pause or resume play, press ►||.
  - To skip to the previous/next title/ chapter/track, press ◀ / ▶.

### \* Tip

- To play a locked DVD, enter the 6-digit parental control password.

## Select a subtitle language

You can select an audio language for a DVD or DivX (Ultra) video.

- 1 During disc play, press ≡ **OPTIONS (MODE)**.
  - ↳ An option menu appears.
- 2 Press ▲ / ▼ repeatedly to select [Subtitle], then press **OK** to confirm.
  - ↳ The language options appear.

- 3 Press ▲ / ▼ repeatedly to select a subtitle language, then press **OK** to confirm.

#### Note

- For some DVDs, the language can only be changed from the disc menu. Press **Home**, then select **Setup** to access the menu.

## Play from USB or recorded discs

You can play DivX (Ultra)/MP3/JPEG picture files copied onto a CD-R/RW, recordable DVD or USB storage device.

- 1 Select a source.
  - For a USB storage device, press **USB**.
  - For a disc, press **DISC**.
- 2 Insert the USB storage device or load the disc.
- 3 Press ▲ / ▼ to select a folder; then press **OK** to confirm.
- 4 Press ▲ / ▼ to select a file, then press **OK** to start play.
  - To stop play, press **Stop**.
  - To pause/resume play, press **Play/Pause**.
  - To return to the upper-level directory, press **Back**.
  - To skip to the previous/next file, press **Left/Right**.

#### Note

- You can only play DivX (Ultra) videos rented or purchased through the DivX registration code of this unit.
- Subtitle files with the following filename extensions (.srt, .smi, .sub, .ssa, .ass) are supported but do not appear on the file navigation menu.
- The subtitle filename has to be the same as the file name of the video.

## Play a slideshow with background music

This unit can play MP3 files and JPEG photos simultaneously.

#### Note

- The MP3 and JPEG files must be stored on the same disc or USB storage device.

- 1 Play an MP3 file.
- 2 Select a photo from your photo folder; then press **OK** to start the slideshow.
  - ↳ Slideshow begins and continues until the end of the photo folder.
  - ↳ Audio continues until the end of the last file.
    - To return to the menu, press **Back**.
    - To stop the slideshow, press **Stop**.

## Play control

### Select repeat or shuffle play options

- During MP3/CD play, press **Options (MODE)** repeatedly to select a play option.
  - **One**: repeat the current track/file.
  - **Folder**: repeat all tracks/files in the current album/folder.
  - **Folder**: play all tracks/files in the current album/folder once.
  - **Single**: play the current track/file once.
  - **Off**: resume normal play.
  - **Shuffle**: play all tracks/files randomly.

### Search forward/backward

- During video/audio play, press **Left/Right** ( **Left/Right** ) repeatedly to select a search speed.
  - To resume play at normal speed, press **Play/Pause**.

## Resume video play from last stopped point

### Note

- This feature is only available for DVD/VCD play.
- In stop mode and when the disc has not been removed, press **▶||**.

### To cancel resume mode and stop play completely:

- In stop mode, press **■**.

## Display play information

- During play of an MP3 file, press and hold **↩ BACK (ID3/INFO)** to display ID3 information (if available) on the front panel.

## Enjoy karaoke

You can connect a microphone (not supplied) to sing along with a music source.

### Note

- Before you connect a microphone, set the microphone volume to the minimum level to prevent howling.

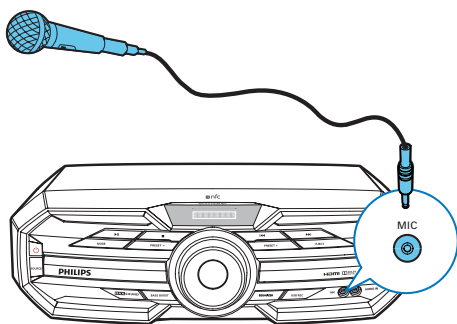

- 1 Insert a Karaoke disc.
- 2 Connect a microphone to the **MIC** socket on the front panel.

- 3 Press **▲**, and then select **[Karaoke]** (Karaoke).
- 4 Turn on the microphone sound output (see 'Adjust karaoke settings').
- 5 Play a Karaoke disc and sing along through the microphone.

## Adjust Karaoke settings

- **[Microphone]** (Microphone): turn on or off the microphone sound output.
- **[Mic Volume]** (Mic Volume): adjust the microphone volume.
- **[Echo Level]** (Echo Level): adjust echo level.
- **[Karaoke Scoring]** (Karaoke Scoring): turn off the function of Karaoke scoring or select a scoring level (basic/intermediate/advance). If a level is selected, the score is displayed after each song ends.
- **[Karaoke Idol]** (Karaoke Idol): compete for singing up to 4 songs among different signers, and the contest result is displayed.

- 1) In the **[Karaoke Scoring]** (Karaoke Scoring) option, select a level (basic/intermediate/advance).
- 2) In the **[Karaoke Idol]** (Karaoke Idol) option, turn on the contest.
  - ↳ The song selection menu is displayed.
- 3) Input a track (VCD/SVCD) or a title/chapter (DVD) as the first song. Up to 4 songs can be selected.
- 4) Then select **[Continue]** (Continue), and press **OK** to start play selected songs.
  - ↳ After all the selected songs end, a contest result is displayed.

- **[Key Shift]** (Key Shift): adjust the pitch level that matches your voice.
- **[Vocal]** (Vocal): select various Karaoke audio modes, or turn off the original vocal.

---

## Adjust volume level and sound effect

### Note

- MAX sound and bass boost cannot be activated at the same time.

---

## Adjust volume level

### Caution

- For your hearing health and being consideration of other people, it is not recommended to listen at high volume levels for a long time.

- During play, press **VOL +/-** to increase/decrease the volume level.

---

## Mute sound

- During play, press **M** to mute/unmute sound.

---

## Boost sound power

The MAX sound feature gives an instant boost to the sound power .

- Press **MAX SOUND** to turn on or off the instant power boost.

---

## Select a preset sound effect

The equalizer setting feature allows you to enjoy special preset sound effects.

- During play, press **EQ** repeatedly to select:
  - [SAMBA] (samba)
  - [FORRO] (forro)
  - [FUNK] (funk)
  - [SERTANEJO] (sertanejo)
  - [POP] (pop)

---

## Enhance bass

You can manually select the level of dynamic bass boost (DBB) that best suits your listening environment.

- During play, press **BASS BOOST** repeatedly to select:
  - DBB 1
  - DBB 2
  - DBB 3
  - DBB off
- ↳ If DBB is activated, **DBB** is displayed.

## 6 Listen to radio

### Tune to a radio station

- 1 Press **FM/AUDIO IN** repeatedly to select the FM radio source.
- 2 Press and hold **◀/▶** (**◀◀/▶▶**) for more than two seconds.
  - ↳ [SEARCH] (search) is displayed.
  - ↳ The radio tunes to a station with strong reception automatically.
- 3 Repeat step 2 to tune to more stations.
  - To tune to a weak station, press **◀/▶** (**◀◀/▶▶**) repeatedly until you find optimal reception.

### Program radio stations automatically

You can program a maximum of 20 FM preset radio stations.

- In tuner mode, press and hold **☰** **OPTIONS (MODE)** for more than two seconds to activate automatic programming.
  - ↳ [AUTO] (auto) is displayed.
  - ↳ All available stations are programmed in the order of waveband reception strength.
  - ↳ The first programmed radio station is broadcast automatically.

### Program radio stations manually

You can program a maximum of 20 FM preset radio stations.

- 1 Tune to a radio station.
- 2 Press **☰** **OPTIONS (MODE)** to activate program mode.
- 3 Press **▲/▼** to allocate a number to this radio station, then press **☰** **OPTIONS (MODE)** to confirm.
- 4 Repeat the above steps to program other stations.



Tip

- To overwrite a programmed station, store another station in its place.

### Select a preset radio station

- In tuner mode, press **▲/▼** to select a preset number.



Tip



- Position the antennas as far as possible from TV, VCR or other radiation source.
- For optimal reception, fully extend and adjust the position of the antennas.

# 7 USB record

Audio CD tracks are recorded in .mp3 format.

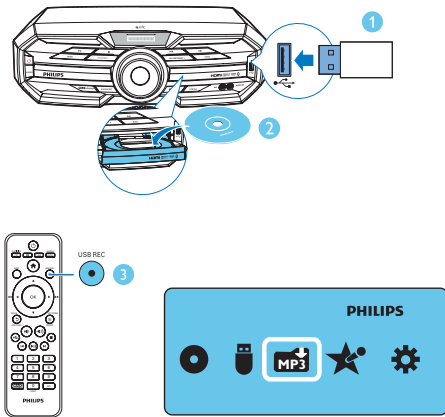
The first time you record to USB, a folder is automatically created in the USB device. Each time you record to USB, the recorded files are stored in a sub-folder. Files and sub-folders are named numerically in the order by which they are created.



- 1 Load a CDDA disc onto the disc tray and close the disc compartment (see 'Play a disc' on page 17).
- 2 Insert a USB device into the  socket on the front panel.
- 3 Press **USB REC**  to enter the home page with  highlighted.
- 4 Press **OK** to enter the recording menu and follow on-screen instructions to continue.

## Note

- DTS CDs and copy-protected CDs cannot be converted.
- A write-protected or encrypted USB storage device cannot be used to store MP3 files.



## 8 Adjust settings

- 1 Press **▲**.
- 2 Select the **[Setup]** (Setup) page.
- 3 Select a setting and press **OK**.
  - To return to the previous menu, press **↶ BACK**.
  - To exit the menu, press **▲**.

### General setup

On the **[General]** (general) page, you can set the following options:

#### [Disc Lock]

Sets play restriction for a specific discs. Before you start, place the disc in the disc compartment (maximum 20 discs can be locked).

- **[Lock]** – Restricts access to the current disc. Once activated, a password is needed to unlock and play the disc.
- **[Unlock]** – Plays all discs.



Tip

- You can set or change the password.

#### [Display Dim]

Changes the brightness level of the display panel on the unit.

- **[100%]** – Normal brightness.
- **[70%]** – Medium brightness.
- **[40%]** – Dimmest display.

#### [OSD Language]

Selects the default on-screen menu language.

#### [Sleep Timer]

Switches to standby automatically after the preset time.

- **[15 mins]**, **[30 mins]**, **[45 mins]**, **[60 mins]** – Selects the count down time before the unit switches to standby.
- **[Off]** – Disables sleep timer mode.

**[Auto Standby]** (only available for DISC and USB mode)

Turns off or on automatic standby switching mode. It is an energy saving feature.

- **[On]** – Switches to standby after 15 minutes of inactivity (for example, in pause or stop mode).
- **[Off]** – Disables auto standby mode.

#### [DivX(R) VOD Code]

Displays the DivX® registration code.



Tip

- Enter the DivX registration code of the unit when you rent or purchase video from [www.divx.com/vod](http://www.divx.com/vod). The DivX videos rented or purchased through the DivX® VOD (Video On Demand) service can be played only on the device to which it is registered.

### Video setup

On the **[Video]** (Video) page, you can set the following options:

#### [TV System]

Changes this setting if the video does not appear correctly. By default, this setting matches the most common setting for TVs in your country.

- **[PAL]** – For PAL-system TV.
- **[NTSC]** – For NTSC-system TV.
- **[Multi]** – For TV that is compatible with both PAL and NTSC.

## [TV Display]

Selects one of the following display formats:



- **[4:3 Pan Scan]** – For 4:3 screen TV: full-height display with the trimmed sides.
- **[4:3 Letter Box]** – For 4:3 screen TV: wide-screen display with black bars on the top and bottom of the screen.
- **[16:9 Wide Screen]** – For wide-screen TV: display ratio 16:9.

### [Picture Setting] (for JPEG display)

Selects different slide-show play modes: **[Wipe Top]**, **[Wipe Bottom]**, **[Wipe Left]**, **[Wipe Right]**, **[Left Top]**, **[Right Top]**, **[Left Bottom]** and **[Right Bottom]**.

### [HD JPEG]

Enjoys untouched and uncompressed JPEG pictures at its original resolution when you connect the unit and the TV with a HDMI cable.

- **[On]** – Displays high definition picture.
- **[Off]** – Displays standard picture.

### Note

- The unit supports the resolution display of 720p and above.

## [HDMI Setup]

Selects the HDMI video setting when you connect the unit and the TV with a HDMI cable.

**[Wide Screen Format]** – Defines the wide screen format for disc play.

Option	Description
<b>[Superwide]</b>	Center position of the screen is stretched less than the side. Applicable only to 720p and above video resolution setting.
<b>[4:3 Pillar Box]</b>	No stretching of the picture. Black bars are displayed on both sides of the screen.
<b>[Off]</b>	Picture is displayed according to the format of the disc.

- **[HDMI Video]** – Selects the HDMI video output resolution that is compatible with your TV display capability.

Option	Description
<b>[Auto]</b>	Detects and selects the best supported video resolution automatically.
<b>[480i], [576i], [480p], [576p], [720p], [1080i], [1080p]</b>	Selects a video resolution that is best supported by the TV. See the TV manual for details.

## Audio setup

On the **[Audio]** (Audio) page, you can set the following options:

### [HDMI Audio]

Selects the HDMI audio setting when you connect the unit and the TV with a HDMI cable.

- **[On]** – Allows audio output through the TV and the speaker system. If the audio format on the disc is not supported, it will be downmixed to two-channel sound (linear-PCM).

- **[Off]** – Disables audio output from the TV. The sound is only output through the speaker system.

### [Audio Sync]

Sets the default delay time for audio output when you play a video disc.

- 
- 1) To start, press **OK**.
  - 2) Select a speaker delay in the menu, then press **◀▶** to set the delay time.
  - 3) Press **OK** to confirm and exit.
- 

### [Speaker Setup]

Optimizes surround output for the connected speakers system.

- **[Speakers Volume]** – Sets the volume level of each speaker to get the ideal audio balance.
- ① Press **OK**.
  - ② Select a speaker, then press **◀▶** to adjust the volume.
  - ③ Press **OK** to confirm and exit.

### [Sound Mode]

Selects a preset sound effect to enhance the audio output.

- **[MAX ON], [JAZZ], [ROCK], [TECHNO], [POP]**

### [Treble/Bass]

Sets the high frequency (treble) and low frequency (bass) settings of the unit.

### [Night Mode]

Makes loud sound level softer and soft sound level louder so that you can watch the DVD movies at a low volume, without disturbing others.

- **[On]** – Enjoys quiet viewing at night.
- **[Off]** – Enjoys surround sound with a full dynamic range.

#### Note

- This feature is applicable only to Dolby Digital encoded discs.

## Preferences

On the **[Preference]** (Preference) page, you can set the following options:

### [Audio]

Selects the default audio language for disc play.

### [Subtitle]

Selects the default subtitle language for disc play.

### [Disc Menu]

Selects the language for disc menu.

#### Note

- If the language you have set is not available on the disc, the disc uses its own default language.
- For some discs, the subtitle/audio language can only be changed from the disc menu.
- To select the languages that are not listed in the menu, select **[Others]**. Then check the Language Code list at the back of this user manual and enter the respective 4-digit language code.

### [Parental Control]

Restricts access to discs that are unsuitable for children. These types of discs must be recorded with ratings.

- 
- 1) Press **OK**.
  - 2) Select a rating level, and then press **OK**.
  - 3) Press the numeric keys to enter the password.
-

## Note

- Rated discs above the level you set in **[Parental Control]** (Parental Control) require a password to be played.
- The ratings are country-dependent. To allow all discs to play, select **[8 Adult]** (8 Adult).
- Some discs have ratings printed on them but are not recorded with ratings. This function has no effect on such discs.

## [PBC]

Plays VCD interactively according to the menu screen.

- **[On]** (On): The menu screen is displayed.
- **[Off]** (Off): Normal play is resumed.

## [Password]

This setting allows you to change the password for parental control. The default password is 000000.

- 1) Press the numeric keys to enter '000000' or your last set password at **[Old Password]** field.
- 2) Enter the new password at **[New Password]** field.
- 3) Enter the new password again at **[Confirm PWD]** field.
- 4) Press **OK** to exit the menu.

## Note

- If you forget the password, enter '000000' before you set a new password.

## [DivX Subtitle]

Selects a character set that supports the DivX subtitle.

## Note

- Make sure that the subtitle file has the exact same file name as the movie file. If for example the file name of the movie is 'Movie.avi', and then you will need to name the text file 'Movie.sub' or 'Movie.srt'.

## [Version Info]

Displays the software version of the unit.

## [Default]

Resets all the settings to factory default, except for the password and parental settings.

# 9 Product information

## Note

- Product information is subject to change without prior notice.

## Specifications

### Amplifier

Rated Output Power	4 X 75 W RMS
Frequency Response	20 Hz-20 kHz / ±3 dB
Signal to Noise Ratio	≥ 65 dBA
AUDIO Input	1V RMS 22k ohm

### Disc

Laser Type	Semiconductor
Disc Diameter	12 cm/8 cm
Video Decoding	MPEG-1 / MPEG-2 / DivX
Video DAC	12 Bits
Signal System	PAL / NTSC
Video Format	4:3 / 16:9
Video Luminance S/N	> 55 dB
Audio DAC	24 Bits / 96 kHz
Total Harmonic Distortion	≤ 1% (1 kHz)

### Tuner (FM)

Tuning Range	87.5 - 108 MHz
Tuning grid	50 KHz

Sensitivity - Mono, 26dB S/N Ratio	< 22 dBf
Total Harmonic Distortion	< 3%
Signal to Noise Ratio	> 50dB

### Speakers

Speaker Impedance	8 ohm
Speaker Driver	5.25 inch woofer*2 + 2 inch tweeter*2
Sensitivity	84dB/1M/1W

### Bluetooth

Bluetooth version	V2.1 + EDR
Frequency band	2.4GHz ~ 2.48GHz ISM Band
Range	10m (free space)

### General information

AC power	110-240V ~ 50-60 Hz
Operation Power Consumption	60W
Standby Power Consumption	< 0.5W
Composite Video Output	1.0Vp-p, 75 ohm
USB Direct	Version 2.0
Dimensions	
- Main Unit (W x H x D)	467 X 140 X 320 mm
- Speaker (W x H x D)	205 X 309 X 145 mm

### Weight

- Main Unit	3.1 kg
- Speaker Box	2 x 2.2kg

---

## Supported disc formats

- Digital Video Discs (DVDs)
- Video CDs (VCDs)
- SuperVideo CDs (SVCDs)
- Digital Video Discs + Rewritable (DVD+RW)
- Compact Discs (CDs)
- Picture (Kodak, JPEG) files on CDR(W)
- DivX(R) disc on CD-R(W):
- DivX 3.11, 4.x and 5.x

### Supported MP3-CD formats:

- ISO 9660
- Max. title/album name: 12 characters
- Max. title number plus album: 255.
- Max. nested directory: 8 levels.
- Max. album number: 32.
- Max. MP3 track number: 999.
- Supported sampling frequencies for MP3 disc: 32 kHz, 44.1 kHz, 48 kHz.
- Supported Bit-rates of MP3 disc are: 32, 64, 96, 128, 192, 256 (kbps).
- The following formats are not supported:
  - Files like \*.VMA, \*.AAC, \*.DLF, \*.M3U, \*.PLS, \*.WAV
  - Non-English Album/Title name
  - Discs recorded in Joliet format
  - MP3 Pro

---

## USB playability information

### Compatible USB storage devices:

- USB flash memory (USB 2.0 or USB1.1)
- USB flash players (USB 2.0 or USB1.1)
- memory cards (requires an additional card reader to work with this apparatus)

### Supported formats:

- USB or memory file format FAT16, FAT32 (sector size: 512 bytes)
- MP3 bit rate (data rate): 32-320 Kbps and variable bit rate
- Directory nesting up to a maximum of 8 levels
- Number of albums/ folders: maximum 99
- Number of tracks/titles: maximum 999
- ID3 tag v2.0 or later
- File name in Unicode UTF8 (maximum length: 128 bytes)

### Unsupported formats:

- Empty albums: an empty album is an album that does not contain MP3 files, and is not be shown in the display.
- Unsupported file formats are skipped. For example, Word documents (.doc) or MP3 files with extension .dlf are ignored and not played.
- AAC, WAV, PCM audio files
- WMA files

# 10 Troubleshooting



## Caution

- Never remove the casing of this apparatus.

To keep the warranty valid, never try to repair the system yourself.

If you encounter problems when using this apparatus, check the following points before requesting service. If the problem remains unsolved, go to the <brand> web site ([www.<brand>.com/support](http://www.<brand>.com/support)). When you contact <brand>, ensure that your apparatus is nearby and the model number and serial number are available.

### No power

- Make sure that the power cord of the unit is connected properly.
- Make sure that there is power at the AC outlet.
- If [**Auto Standby**] has been turned on, the system switches off automatically after 15 minutes of inactivity (for example, in pause or stop mode).

### No disc detected

- Insert a disc.
- Check if the disc is inserted upside down.
- Wait until the moisture condensation at the lens has cleared.
- Replace or clean the disc.
- Use a finalized CD or correct format disc.

### No picture

- Check the video connection.
- Turn on the TV to the correct Video-In channel.

### Black and white or distorted picture

- The disc does not match the TV color system standard (PAL/NTSC).

- Sometimes a slight picture distortion may appear. This is not a malfunction.
- Clean the disc.
- A distorted picture may appear during progressive scan setup.

### The aspect ratio of the TV screen cannot be changed even though you have set the TV display format.

- The aspect ratio is fixed on the loaded DVD disc.
- The aspect ratio may not be changed for some TV systems.

### No sound or poor sound

- Adjust the volume.
- Check whether the unit is muted.
- Check that the speakers are connected correctly.
- Check if the stripped speaker wires are clamped.

### Remote control does not work

- Before you press any function button, first select the correct source with the remote control instead of the main unit.
- Reduce the distance between the remote control and the unit.
- Insert the battery with its polarities (+/- signs) aligned as indicated.
- Replace the battery.
- Aim the remote control directly at the sensor on the front of the unit.

### Disc does not play

- Insert a readable disc with the label side facing up.
- Check the disc type, color system and regional code. Check for any scratches or smudges on the disc.
- Disable the password for parental control or change the rating level.
- Moisture has condensed inside the unit. Remove the disc and leave the unit turned on for about an hour. Disconnect and reconnect the AC power plug, and then turn on the unit again.

### **DivX video files cannot be played.**

- Make sure that the DivX video file is complete.
- Make sure that the file extension is correct.
- Due to Digital Rights issues, the DRM-protected video files cannot be played through an analog video connection (for example, composite and component connection). Transfer the video content onto the disc media and play these files.

### **Poor radio reception**

- Increase the distance between the apparatus and your TV or VCR.
- Fully extend the FM antenna.
- Connect an outdoor FM antenna instead.

### **Audio or subtitle languages cannot be set**

- The disc is not recorded with sound or subtitles in multiple languages.
- The audio or subtitle language setting is prohibited on the disc.

### **Cannot display some files in USB device**

- The number of folders or files in the USB device has exceeded a certain limit. This phenomenon is not a malfunction.
- The formats of these files are not supported.

### **USB device not supported**

- The USB device is incompatible with the unit. Try another one.

### **Music playback is unavailable on the system even after successful Bluetooth connection.**

- The device cannot be used with the unit to play music.

### **The audio quality is poor after connection with a Bluetooth-enabled device.**

- The Bluetooth reception is poor. Move the device closer to the unit or remove any obstacle between the device and the unit.

### **Cannot connect with the unit.**

- The device does not support the profiles required for the unit.
- The Bluetooth function of the device is not enabled. Refer to the user manual of the device for how to enable the function.
- The unit is not in pairing mode.
- The unit is already connected with another Bluetooth-enabled device. Disconnect that device or all other connected devices and then try again.

### **The paired mobile phone connects and disconnects constantly.**

- The Bluetooth reception is poor. Move the mobile phone closer to the unit or remove any obstacle between the mobile phone and the unit.
- Some mobile phones may connect and disconnect constantly when you make or end calls. This does not indicate any malfunction of the unit.
- For some mobile phones, the Bluetooth connection may be deactivated automatically as a power-saving feature. This does not indicate any malfunction of the unit.







2014 © WOOX Innovations Limited.

All rights reserved.

Philips and the Philips' Shield Emblem are registered trademarks of Koninklijke Philips N.V. and are used by WOOX Innovations Limited under license from Koninklijke Philips N.V.

FXD18\_98\_User Manual\_V2.0

