

Register your product and get support at  
[www.philips.com/welcome](http://www.philips.com/welcome)

HTS2500



---

EN User manual

---

**PHILIPS**



# Contents

<b>1 Notice</b>	2	<b>7 Update software</b>	12
Copyright	2	Check software version	12
Compliance	2	Update software from a CD-R or USB	12
Mains fuse (UK only)	2		
Trademarks	2	<b>8 Product specifications</b>	12
<b>2 Important</b>	3	<b>9 Troubleshooting</b>	14
Safety	3		
Product care	3		
Disposal of your old product and batteries	4	<b>10 Index</b>	15
<b>3 Your home theatre</b>	4		
Main unit	4		
Remote control	5		
<b>4 Connect your home theatre</b>	6		
Connectors	6		
Connect to the TV	6		
Connect audio from TV or other devices	7		
<b>5 Use your home theatre</b>	7		
Before you start	7		
Choose your sound	7		
Play a disc	8		
Play from a USB storage device	9		
More play features for disc or USB	9		
Play from radio	9		
Play audio from TV or other devices	10		
<b>6 Change settings</b>	10		
Access the setup menu	10		
Change general settings	11		
Change audio settings	11		
Change video settings	11		
Change preference settings	11		

# 1 Notice

## Copyright



Be responsible  
Respect copyrights

This item incorporates copy protection technology that is protected by U.S. patents and other intellectual property rights of Rovi Corporation. Reverse engineering and disassembly are prohibited.

## Copyright in the UK

Recording and playback of material may require consent. See Copyright Act 1956 and The Performers' Protection Acts 1958 to 1972.

## Compliance



This product is in compliance with the essential requirements and other relevant provisions of Directives 2006/95/EC (Low Voltage) and 2004/108/EC (EMC).

## Mains fuse (UK only)

This product is fitted with an approved moulded plug. Should it become necessary to replace the mains fuse, this must be replaced with a fuse of the same value as indicated on the plug (example 10A).

- 1 Remove fuse cover and fuse.
- 2 The replacement fuse must comply with BS 1362 and have the ASTA approval mark. If the fuse is lost, contact your dealer in order to verify the correct type.
- 3 Refit the fuse cover.



### Note

- To conform to the EMC directive (2004/108/EC), the mains plug on this product must not be detached from the mains cord.

## Trademarks



Manufactured under license from Dolby Laboratories. Dolby and the double-D symbol are trademarks of Dolby Laboratories.



DivX®, DivX Certified® and associated logos are registered trademarks of DivX, Inc. and are used under licence.

DivX Ultra® Certified to play DivX® video with advanced features and premium content.

ABOUT DIVX VIDEO: DivX® is a digital video format created by DivX, Inc. This is an official DivX Certified device that plays DivX video. Visit [www.divx.com](http://www.divx.com) for more information and software tools to convert your files into DivX video.

ABOUT DIVX VIDEO-ON-DEMAND: This DivX Certified® device must be registered in order to play DivX Video-on-Demand (VOD) content. To generate the registration code, locate the DivX VOD section in your device setup menu. Go to [vod.divx.com](http://vod.divx.com) with this code to complete the registration process and learn more about DivX VOD.

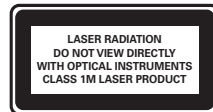

## 2 Important

Read and understand all instructions before you use your home theatre. If damage is caused by failure to follow instructions, the warranty does not apply.

---

### Safety

#### Risk of electric shock or fire!

- Never expose the product and accessories to rain or water. Never place liquid containers, such as vases, near the product. If liquids are spilt on or into the product, disconnect it from the power socket immediately. Contact Philips Consumer Care to have the product checked before use.
- Never place the product and accessories near naked flames or other heat sources, including direct sunlight.
- Never insert objects into the ventilation slots or other openings on the product.
- Where the mains plug or an appliance coupler is used as the disconnect device, the disconnect device shall remain readily operable.
- Disconnect the product from the power socket before lightning storms.
- When you disconnect the power cord, always pull the plug, never the cable.

#### Risk of short circuit or fire!

- Before you connect the product to the power socket, ensure that the power voltage matches the value printed on the back or bottom of the product. Never connect the product to the power socket if the voltage is different.

#### Risk of injury or damage to the home theatre!

- For wall-mountable products, use only the supplied wall mount bracket. Secure the wall mount to a wall that can support the combined weight of the product and the wall mount. Koninklijke Philips Electronics N.V. bears no responsibility for improper wall mounting that result in accident, injury or damage.
- For speakers with stands, use only the supplied stands. Secure the stands to the speakers tightly. Place the assembled stands on flat, level surfaces that can support the combined weight of the speaker and stand.

- Never place the product or any objects on power cords or on other electrical equipment.
- If the product is transported in temperatures below 5°C, unpack the product and wait until its temperature matches room temperature before connecting it to the power socket.
- Visible and invisible laser radiation when open. Avoid exposure to the beam.
- Do not touch the disc optical lens inside the disc compartment.

#### Risk of overheating!

- Never install this product in a confined space. Always leave a space of at least four inches around the product for ventilation. Ensure curtains or other objects never cover the ventilation slots on the product.

#### Risk of contamination!

- Do not mix batteries (old and new or carbon and alkaline etc.).
- Remove batteries if they are exhausted or if the remote control is not to be used for a long time.
- Batteries contain chemical substances; they should be disposed of properly.

---

### Product care

- Do not insert any objects other than discs into the disc compartment.
- Do not insert warped or cracked discs into the disc compartment.
- Remove discs from the disc compartment if you are not using the product for an extended period of time.
- Only use microfibre cloth to clean the product.

## Disposal of your old product and batteries



Your product is designed and manufactured with high quality materials and components, which can be recycled and reused.



When this crossed-out wheeled bin symbol is attached to a product it means that the product is covered by the European Directive 2002/96/EC. Please inform yourself about the local separate collection system for electrical and electronic products.

Please act according to your local rules and do not dispose of your old products with your normal household waste.

Correct disposal of your old product helps to prevent potential negative consequences for the environment and human health.



Your product contains batteries covered by the European Directive 2006/66/EC, which cannot be disposed of with normal household waste.

Please inform yourself about the local rules on separate collection of batteries because correct disposal helps to prevent negative consequences for the environment and human health.

## 3 Your home theatre

Congratulations on your purchase, and welcome to Philips! To fully benefit from the support that Philips offers, register your home theatre at [www.philips.com/welcome](http://www.philips.com/welcome).

### Main unit

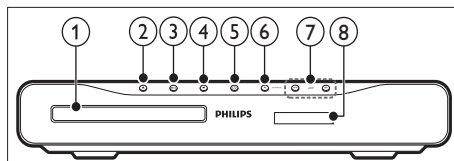

- ① **Disc compartment**
- ② **▲ (Open/Close)**  
Opens or closes the disc compartment.
- ③ **▶|| (Play/Pause)**  
Starts, pauses or resumes play.
- ④ **■ (Stop)**
  - Stops play.
  - In radio mode, erases the current preset radio station.
- ⑤ **⏻ (Standby-On)**  
Switches the home theatre on or to standby.
- ⑥ **SOURCE**  
Selects an audio/video source for the home theatre.
- ⑦ **▲ +/-**  
Increases or decreases volume.
- ⑧ **Display panel**

## Remote control

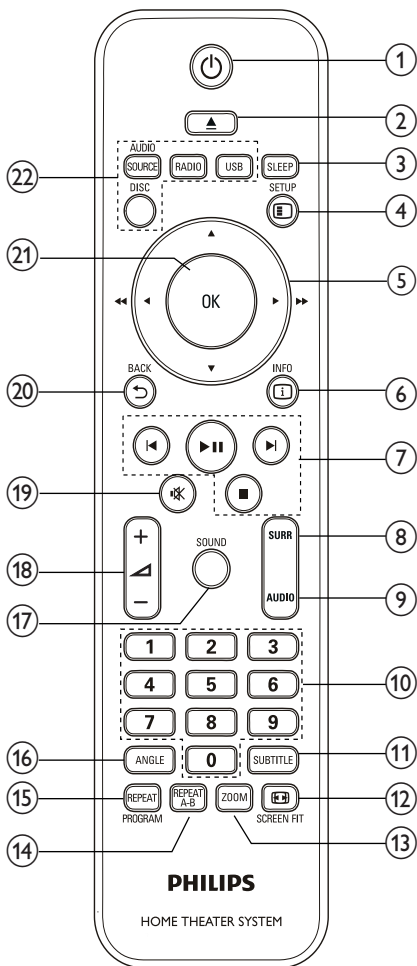

- ① **⏻ (Standby-On)**  
Switches the home theatre on or to standby.
- ② **▲ (Open/Close)**  
Opens or closes the disc compartment.
- ③ **SLEEP**  
Switches the home theatre to standby after the preset time selected.
- ④ **⌂ SETUP**  
Accesses or exits the setup menu.
- ⑤ **▲▼◀▶ (Navigation buttons)**
  - Navigate menus.
  - In video mode, press left or right to fast backward or fast forward.
  - In radio mode, press left or right to search for a radio station; press up or down to fine tune a radio frequency.
- ⑥ **ℹ INFO**  
Displays information about what is playing.
- ⑦ **Playback buttons**  
Control playback.
- ⑧ **SURR (Surround Sound)**  
Switches to surround sound or stereo sound.
- ⑨ **AUDIO**  
Selects an audio language or channel.
- ⑩ **Numeric buttons**  
Selects an item to play.
- ⑪ **SUBTITLE**  
Selects subtitle language for video.
- ⑫ **Ⓜ SCREEN FIT**  
Fits the picture format to the TV screen.
- ⑬ **ZOOM**  
Zooms into a video scene or picture.
- ⑭ **REPEAT A-B**  
Marks two points within a chapter or track for repeat play, or turns off repeat mode.
- ⑮ **REPEAT / PROGRAM**
  - Selects or turns off repeat mode.
  - In radio mode, programme radio stations.
- ⑯ **ANGLE**  
Displays options for different camera angles.
- ⑰ **SOUND**  
Selects a sound mode.
- ⑱ **▲ +/-**  
Increases or decreases volume.
- ⑲ **\* (Mute)**  
Mutes or restores volume.
- ⑳ **⏪ BACK**  
Returns to a previous menu screen.
- ㉑ **OK**  
Confirms an entry or selection.
- ㉒ **Source buttons**
  - **AUDIO SOURCE:** Selects an audio input source.
  - **RADIO:** Switches to FM radio.
  - **USB:** Switches to USB storage device.
  - **DISC:** Switches to disc source.

## 4 Connect your home theatre

### theatre

This section helps you connect your home theatre to a TV and other devices. The basic connections of the home theatre with its accessories are provided in the Quick Start. For a comprehensive interactive guide, see [www.connectivityguide.philips.com](http://www.connectivityguide.philips.com).

#### Note

- Refer to the type plate at the back or bottom of the product for identification and supply ratings.
- Before you make or change any connections, ensure that all devices are disconnected from the socket.

## Connectors

Connect other devices to your home theatre.

### Side connectors

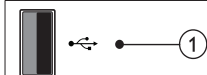

- 1 **USB**  
Audio, video or picture input from a USB storage device.

### Back connectors

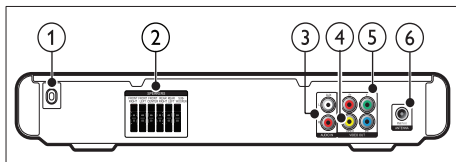

- 1 **AC MAINS~**  
Connects to the power supply.
- 2 **SPEAKERS**  
Connects to the supplied speakers and subwoofer.

- 3 **AUDIO IN-AUX**  
Connects to the analogue audio output on the TV or an analogue device.
- 4 **VIDEO OUT-VIDEO**  
Connects to the composite video input on the TV.
- 5 **VIDEO OUT-Y Pb Pr**  
Connects to the component video input on the TV.
- 6 **FM ANTENNA**  
Connects the FM antenna for radio reception.

## Connect to the TV

Connect your home theatre directly to a TV through one of the following connectors (from highest to basic quality video):

- 1 **Component video**
- 2 **Composite video**

### Option 1: Connect to the TV through YPbPr (component video)

#### Note

- The component video cable or connector might be labelled **Y Cb Cr** or **YUV**.

(Cable not supplied)

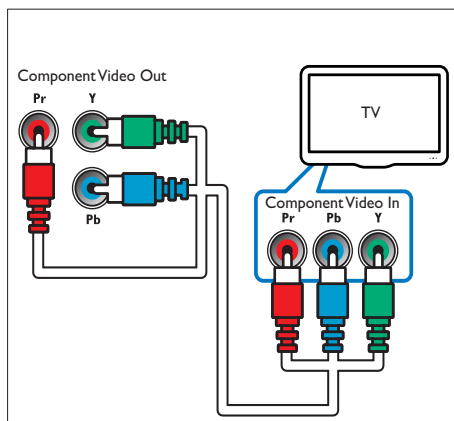



## Option 2: Connect to the TV through composite video (CVBS)

### Note

- The composite video cable or connector might be labelled **AV IN**, **VIDEO IN**, **COMPOSITE** or **BASEBAND**.

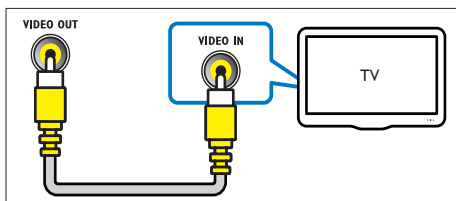

## Connect audio from TV or other devices

Use your home theatre to play audio from the TV or another device such as a cable box.

### Tip

- Press **AUDIO SOURCE** to select the audio output of your connection.

(Cable not supplied)

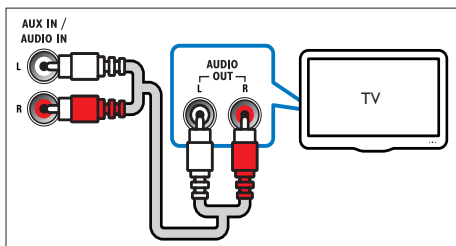

# 5 Use your home theatre

This section helps you use the home theatre to play media from a wide range of sources.

## Before you start

Make sure that you:

- Make the necessary connections and complete the setup as described in the Quick Start.
- Switch the TV to the correct source for the home theatre.

## Choose your sound

This section helps you choose the ideal sound for your video or music.

### Change sound mode

Select predefined sound modes to suit your video or music.

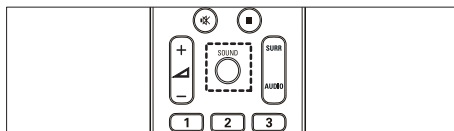

Press **SOUND** repeatedly to cycle through the available sound modes.

Sound mode	Description
<b>ACTION / ROCK</b>	Enhanced low and high-range. Ideal for action movies and rock or pop music.
<b>DRAMA / JAZZ</b>	Clear mid and high-range. Ideal for drama movies and jazz music.
<b>CONCERT/ CLASSIC</b>	Neutral sound. Ideal for live concerts and classical music.
<b>SPORTS</b>	Moderate mid-range and surround effects for clear vocals and the atmosphere of a live sport venue.
<b>NIGHT</b>	Dynamically controlled sound mode suitable for watching movies at night or for non-intrusive background music.

## Change surround sound mode

Experience an immersive audio experience with surround sound modes.

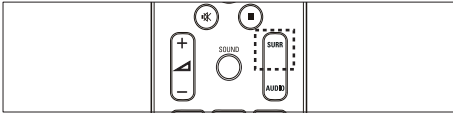

Press **SURR** repeatedly to cycle through the available surround modes.

Option	Description
<b>MULTI-CHANNEL</b>	Immersive multi-channel sound for an enhanced movie experience.
<b>STEREO</b>	Two-channel stereo sound. Ideal for listening to music.

## Play a disc

The home theatre can play a wide variety of discs, including video, audio and mixed media (for example, a CD-R that contains JPEG pictures and MP3 music).

- 1 Insert a disc into the home theatre.
- 2 Press **DISC**.  
↳ The disc plays or the disc main menu appears.
- 3 Press the following buttons to control play:

Button	Action
<b>Navigation buttons</b>	Navigate menus.
<b>OK</b>	Confirms an entry or selection.
<b>▶  </b>	Starts, pauses or resumes play.
<b>■</b>	Stops play.
<b>◀/▶</b>	Skips to the previous or next track, chapter or file.
<b>◀◀/▶▶</b>	Fast backwards or fast forwards. Press repeatedly to change the search speed.
<b>ZOOM</b>	Zooms into a video scene or picture.
<b>REPEAT A-B</b>	Marks two points within a chapter or track for repeat play, or turns off repeat mode.
<b>SCREEN FIT</b>	Fits the picture format to the TV screen.

## Use video options

Access several useful features while viewing video.

### Note

- Available video options depend on the video source.

Button	Action
<b>▲/▼</b>	Searches slow-backwards or slow-forwards. Press repeatedly to change the search speed. For VCD/SVCD, slow-backwards search is not available.
<b>AUDIO</b>	Selects an audio language or channel.
<b>SUBTITLE</b>	Selects subtitle language for video.
<b>INFO</b>	Displays information about what is playing.
<b>REPEAT</b>	Repeats a chapter or title.
<b>REPEAT A-B</b>	Marks two points within a chapter for repeat play, or turns off repeat mode.
<b>ANGLE</b>	Displays options for different camera angles.

## Use picture options

Access several useful features while viewing pictures.

Button	Action
<b>▲/▼</b>	Rotates the picture anti-clockwise or clockwise.
<b>◀/▶</b>	Skips to the previous or next picture.
<b>REPEAT</b>	Toggles between various repeat modes.
<b>INFO</b>	Displays photo albums in a thumbnail overview.

## Use audio options

Access several useful features while audio is played.

Button	Action
REPEAT	Selects or turns off repeat mode.
REPEAT A-B	Marks two points within a track for repeat play, or turns off repeat mode.

## Play from a USB storage device

The home theatre is fitted with a USB connector that allows you to view pictures, listen to music or watch movies stored on a USB storage device.

- 1 Connect the USB storage device to the home theatre.
- 2 Press **USB**.  
↳ A content browser appears.
- 3 Select a file, then press **OK**.
- 4 Press the playback buttons to control play (see 'Play a disc' on page 8).

### Note

- If the USB storage device does not fit into the connector, use a USB extension cable.
- The home theatre does not support digital cameras that need a computer program to display photos.
- The USB storage device must be FAT or DOS-formatted, and Mass Storage Class compliant.

## More play features for disc or USB

Several advanced features are available for video or picture playback from a disc or USB storage device.

### Play a musical slideshow

Play music and pictures simultaneously to create a musical slideshow. The files must be stored on the same disc or USB storage device.

- 1 Play a music track.
- 2 Navigate to the picture file, then press **OK** to start slideshow.
- 3 Press **■** to stop slideshow.
- 4 Press **■** again to stop music.

## Quick skip play to a specific time

Quick skip to a specific part of a video by entering the time of a scene.

- 1 During video play, press **INFO**.
- 2 Press the **Navigation buttons** and **OK** to select:
  - **[TT Time]** : Title time.
  - **[Ch Time]** : Chapter time.
  - **[Disc Time]** : Disc time.
  - **[Track Time]** : Track time.
- 3 Enter the time of the scene, then press **OK**.

## Play from radio

The home theatre can store up to 40 radio stations.

- 1 Check that the FM antenna is connected.
- 2 Press **RADIO**.  
↳ "AUTO INSTALL...PRESS PLAY" appears on the display panel if you have not installed any radio stations. Press **▶||**.
- 3 Press the following buttons to control play:

Button	Action
<b>1◀/▶1</b>	Selects a preset radio station.
<b>◀◀/▶▶</b>	Searches for a radio station.
<b>▲▼</b>	Fine tunes a radio frequency.
<b>■</b>	Press and hold to erase the preset radio station. Press to stop the installation of radio stations.

**PROGRAM** Manual: Press once to access programme mode, and press again to store the radio station.  
Automatic: Press and hold for five seconds to reinstall radio stations.

### Note

- AM and digital radio are not supported.
- If no stereo signal is detected, you are prompted to install the radio stations again.
- For the best reception, place the antenna away from the TV or other sources of radiation.

---

## Play audio from TV or other devices

Press **AUDIO SOURCE** repeatedly to select the audio output of the connected device (see 'Connect audio from TV or other devices' on page 7).

## 6 Change settings

This section helps you to change the settings of your home theatre.







### Caution

- Most of the settings are already configured with the best value for the home theatre. Unless you have a specific reason to change a setting, it is best to leave it at the default value.

---

## Access the setup menu

- 1 Press **⏏** **SETUP**.  
↳ The following menu appears.

Symbol	Description
	[General Setup]
	[Audio Setup]
	[Video Setup]
	[Preference Setup]

- 2 Select a setup menu, then press **OK**.  
See the following sections for information about how to change the settings of your home theatre.
- 3 Press **↶** **BACK** to return to the previous menu, or press **⏏** **SETUP** to exit.



### Note

- You cannot change a setting that is greyed out.

## Change general settings

- 1 Press **⏏** **SETUP**.
- 2 Select **[General Setup]**, then press **OK**.
- 3 Select and adjust the following settings:
  - **[OSD Language]** : Selects the on-screen display menu language.
  - **[Screen Saver]** : Enables or disables screen saver mode. If enabled, the screen enters idle mode after 10 minutes of inactivity (for example, in pause or stop mode).
  - **[DivX(R) VOD Code]** : Displays the DivX VOD registration code for the home theatre.
- 4 Press **OK** to confirm your choice.

### Note

- Before you purchase DivX videos and play them on the home theatre, register the home theatre on [www.divx.com](http://www.divx.com) using the DivX VOD code.

## Change audio settings

- 1 Press **⏏** **SETUP**.
- 2 Select **[Audio Setup]**, then press **OK**.
- 3 Select and adjust the following settings:
  - **[Speakers Volume]** : Sets the volume of each speaker to obtain the ideal audio balance.
  - **[Speakers Delay]** : Sets the delay time for centre and rear speakers to obtain an equal audio transmission from all the speakers.
- 4 Press **OK** to confirm your choice.

## Change video settings

- 1 Press **⏏** **SETUP**.
- 2 Select **[Video Setup]**, then press **OK**.
- 3 Select and adjust the following settings:
  - **[TV System]** : Selects a TV system that is compatible with the TV.
  - **[TV Display]** : Selects a picture display format to fit the TV screen
  - **[Screen Fit]** : Selects a full screen format that best fits to the TV screen.
  - **[Picture Settings]** : Selects a predefined colour setting.

- **[Progressive]** : Enables or disables progressive scan mode.

- 4 Press **OK** to confirm your choice.

### Note

- The best setting is automatically selected for the TV. If you need to change the setting, ensure that the TV supports the new setting.
- Some video settings depend on the video source, ensure that the disc and the TV support the setting or feature.

## Change preference settings

- 1 Press **⏏** **SETUP**.
- 2 Select **[Preference Setup]**, then press **OK**.
- 3 Select and adjust the following settings:
  - **[Audio]** : Selects audio language for video.
  - **[Subtitle]** : Selects subtitle language for video.
  - **[Disc Menu]** : Selects menu language for video disc.
  - **[Parental]** : Restricts access to discs that are recorded with ratings. To play all discs irrespective of the rating, select level '8'.
  - **[PBC]** : Displays or skips the content menu for VCD and SVCD discs.
  - **[Password]** : Sets or changes a PIN code to play a restricted disc. Enter '0000' if you do not have a PIN or if you have forgotten your PIN.
  - **[DivX Subtitle]** : Selects a character set that supports the DivX subtitle.
  - **[Version Info.]** : Displays the software version for the home theatre.
  - **[Default]** : Resets the home theatre to the default settings programmed at the factory.
- 4 Press **OK** to confirm your choice.

### Note

- If your preferred disc language is not available, you can select **[Other]** from the list and enter the 4-digit language code which can be found at the back of this manual.
- If you select a language that is not available on a disc, the home theatre uses the default language of the disc.
- You cannot reset disc lock, password (PIN code) and parental control settings to their default values.

## 7 Update software

To check for new updates, compare the current software version of your home theatre with the latest software version (if available) on the Philips website.

### Check software version

- 1 Press **⏏** **SETUP**.
- 2 Select **[Preference Setup] > [Version Info.]**, then press **OK**.  
↳ The software version is displayed.

### Update software from a CD-R or USB

- 1 Check for the latest software version on [www.philips.com/support](http://www.philips.com/support).
    - Search for your model and click on 'software&drivers'.
  - 2 Download the software onto a CD-R or USB storage device.
  - 3 Insert the CD-R or connect the USB storage device to the home theatre.
  - 4 Follow the instructions on the TV to confirm the update.  
↳ When complete, the home theatre automatically switches off and on again.
- If not, disconnect the power cord for a few seconds and then reconnect it.

#### Caution

- Do not turn off the power or remove the CD-R or USB storage device when the software update is in progress because you might damage the home theatre.

## 8 Product specifications

#### Note

- Specification and design are subject to change without notice.

#### Region code

The type plate on the back or bottom of the home theatre shows which regions it supports

Country	DVD
Europe, United Kingdom	
Asia Pacific, Taiwan, Korea	
Latin America	
Australia, New Zealand	
Russia, India	
China	

#### Playback media

DVD-Video, DVD+R/+RW, DVD-R/-RW, CD-R/CD-RW, Audio CD, Video CD/SVCD, Picture CD, MP3-CD, WMA-CD, DivX-CD, USB storage device

#### File Format

- Audio: .mp3, .wma
- Video: .divx, .divx ultra, .mpeg, .mpg, .wmv (simple profile)
- Picture: .jpeg, .jpg

#### Amplifier

- Total output power: 300 W RMS (30% THD)
- Frequency response: 20 Hz-20 kHz/±3 dB
- Signal-to-noise ratio: > 65 dB (CCIR)/(A-weighted)
- Input sensitivity:
  - AUX: 1000 mV

## Video

- Signal system: PAL/NTSC

## Audio

- Sampling frequency:
  - MP3: 32 kHz, 44.1 kHz, 48 kHz
  - WMA: 44.1 kHz, 48 kHz
- Constant bit rate:
  - MP3: 112 kbps - 320 kbps
  - WMA: 48 kbps - 192 kbps

## Radio

- Tuning range: FM 87.5-108 MHz (50 kHz)
- Signal-to-noise ratio: FM 50 dB
- Frequency response: FM 180 Hz-10 kHz/±6 dB

## USB

- Compatibility: USB
- Class support: UMS (USB Mass Storage Class)
- File system: FAT16, FAT32
- Maximum memory support: < 160 GB

## Main Unit

- Power supply: 110-240 V, ~50-60 Hz;
- Power consumption: 55 W
- Standby power consumption:  $\leq 0.9$  W
- Dimensions (WxHxD): 360 x 58 x 303 (mm)
- Weight: 2.3 kg

## Subwoofer

- Impedance: 12 ohm
- Speaker drivers: 133 mm (5.25") woofer
- Frequency response: 20 Hz-150 Hz
- Dimensions (WxHxD): 160 x 267.5 x 265 (mm)
- Weight: 2.65 kg
- Cable length: 2 m

## Speakers

- System: full range satellite
- Speaker impedance: 3 ohm
- Speaker drivers: 3" full range
- Frequency response: 150 Hz-20 kHz
- Dimensions (W x H x D): 100 x 100 x 75 (mm)
- Weight: 0.30~0.66 kg/each
- Cable length:
  - Centre: 1 m
  - Front: 2 m
  - Rear: 10 m

## Laser specification

- Type: Semiconductor laser GaAlAs (CD)
- Wave length: 645 - 665 nm (DVD), 770 - 800 nm (CD)
- Output power: 6 mW (DVD), 7 mW (VCD/CD)
- Beam divergence: 60 degrees.

# 9 Troubleshooting



## Warning

- Risk of electric shock. Never remove the casing of the product.

To keep the warranty valid, never try to repair the product yourself.

If you have problems using this product, check the following points before you request service. If you still have a problem, register your product and get support at [www.philips.com/welcome](http://www.philips.com/welcome).

If you contact Philips, you will be asked for the model and serial number of your product. The model number and serial number are on the back or bottom of your product. Write the numbers here:

Model No. \_\_\_\_\_

Serial No. \_\_\_\_\_

---

## Main unit

### The buttons on this home theatre do not work.

- Disconnect the home theatre from the socket for a few minutes, then reconnect.

---

## Picture

### No picture.

- Ensure that the TV is switched to the correct source for this home theatre.
- If this happens when you change the TV system, switch to its default mode:  
1) Press **▲** 2) Press **◀** 3) Press **SUBTITLE**.
- If this happens when you switch on the progressive scan mode, switch to its default mode: 1) Press **▲** 2) Press **◀** 3) Press **AUDIO**.

---

## Sound

### No sound.

- Ensure that the audio cables are connected and select the correct input source (for example, **AUDIO SOURCE**) for the device you want to play.

### No sound from TV programme.

- Connect an audio cable from the audio input on the home theatre to the audio output on the TV, then press **AUDIO SOURCE** repeatedly to select the correct audio source.

### Distorted sound or echo.

- Ensure that the TV volume is muted or set to minimum if you are playing audio through the home theatre.

---

## Play

### Disc cannot be played.

- Clean the disc.
- Ensure that the home theatre supports the disc (see 'Product specifications' on page 12).
- Ensure that the home theatre supports the region code of the DVD.
- For DVD±RW or DVD±R, ensure that the disc is finalised.

### DivX video files cannot be played.

- Ensure that the DivX file is encoded according to the 'Home Theatre Profile' with the DivX encoder.
- Ensure that the DivX video file is complete.

### DivX subtitles do not display correctly.

- Ensure that the subtitle file name is the same as the movie file name.
- Select the correct character set: 1) Press **⏏** **SETUP**. 2) Select **[Preference Setup]**. 3) Select **[DivX Subtitle]**. 4) Select a supported character set. 5) Press **OK**.

### The contents of a USB storage device cannot be read.

- Ensure that the format of the USB storage device is compatible with the home theatre (see 'Product specifications' on page 12).
- Ensure that the USB storage device is formatted with a file system that is supported by the home theatre.

### 'No entry' or 'x' sign appears on the TV.

- The operation is not possible.



# 10 Index

---

## A

amplifier	12
audio	
connection	7
language	8

---

## C

care	3
change settings	10
connect	
audio from TV	7, 10
guide	6
other devices	7
TV	6
connectors	6
contact us	14

---

## D

disc	
play	8
supported discs	12
disposal of your product	4

---

## F

file formats	12
--------------	----

---

## O

overview	
connectors	6
main unit	4
remote control	5

---

## P

picture	
slide show	9
troubleshooting	14
play	
disc	8
options	8
radio	9
troubleshooting	14
USB storage device	9
product care	3
product specifications	12

## R

radio	
play	9
programme	9
tune	9
recycle	4
region code	12
remote control	5
repeat	8

---

## S

safety	3
slideshow	
play musical slideshow	9
software	
update	12
version	12
sound	
mode	7
surround	8
troubleshooting	14
subtitle	
language	8

---

## T

time search video	9
troubleshooting	14
TV	
audio from TV	7, 10
connect	6

---

## U

USB	
play	9
software update	12



# Language Code

Abkhazian	6566	Inupiaq	7375	Pushto	8083
Afar	6565	Irish	7165	Russian	8285
Afrikaans	6570	Íslenska	7383	Quechua	8185
Amharic	6577	Italiano	7384	Raeto-Romance	8277
Arabic	6582	Ivrit	7269	Romanian	8279
Armenian	7289	Japanese	7465	Rundi	8278
Assamese	6583	Javanese	7486	Samoan	8377
Avestan	6569	Kalaallisut	7576	Sango	8371
Aymara	6589	Kannada	7578	Sanskrit	8365
Azerhijani	6590	Kashmiri	7583	Sardinian	8367
Bahasa Melayu	7783	Kazakh	7575	Serbian	8382
Bashkir	6665	Kernewek	7587	Shona	8378
Belarusian	6669	Khmer	7577	Shqip	8381
Bengali	6678	Kinyarwanda	8287	Sindhi	8368
Bihari	6672	Kirghiz	7589	Sinhalese	8373
Bislama	6673	Komi	7586	Slovensky	8373
Bokmål, Norwegian	7866	Korean	7579	Slovenian	8376
Bosanski	6683	Kuanyama; Kwanyama	7574	Somali	8379
Brezhoneg	6682	Kurdish	7585	Sotho; Southern	8384
Bulgarian	6671	Lao	7679	South Ndebele	7882
Burmese	7789	Latina	7665	Sundanese	8385
Castellano, Español	6983	Latvian	7686	Suomi	7073
Catalán	6765	Letzeburgesch;	7666	Swahili	8387
Chamorro	6772	Limburgan; Limburger	7673	Swati	8383
Chechen	6769	Lingala	7678	Svenska	8386
Chewa; Chichewa; Nyanja	7889	Lithuanian	7684	Tagalog	8476
中文	9072	Luxembourgish;	7666	Tahitian	8489
Chuang; Zhuang	9065	Macedonian	7775	Tajik	8471
Church Slavc; Slavonic	6785	Malagasy	7771	Tamil	8465
Chuvash	6786	Magyar	7285	Tatar	8484
Corsican	6779	Malayalam	7776	Telugu	8469
Česky	6783	Maltese	7784	Thai	8472
Dansk	6865	Manx	7186	Tibetan	6679
Deutsch	6869	Maori	7773	Tigrinya	8473
Dzongkha	6890	Marathi	7782	Tonga (Tonga Islands)	8479
English	6978	Marshallese	7772	Tsonga	8483
Esperanto	6979	Moldavian	7779	Tswana	8478
Estonian	6984	Mongolian	7778	Türkçe	8482
Euskara	6985	Nauru	7865	Turkmen	8475
Ελληνικά	6976	Navaho; Navajo	7886	Twi	8487
Faroese	7079	Ndebele, North	7868	Uighur	8571
Français	7082	Ndebele, South	7882	Ukrainian	8575
Frysk	7089	Ndonga	7871	Urdu	8582
Fijian	7074	Nederlands	7876	Uzbek	8590
Gaelic; Scottish Gaelic	7168	Nepali	7869	Vietnamese	8673
Gallegan	7176	Norsk	7879	Volapuk	8679
Georgian	7565	Northern Sami	8369	Walloon	8765
Gikuyu; Kikuyu	7573	North Ndebele	7868	Welsh	6789
Guarani	7178	Norwegian Nynorsk;	7878	Wolof	8779
Gujarati	7185	Occitan; Provençal	7967	Xhosa	8872
Hausa	7265	Old Bulgarian; Old Slavonic	6785	Yiddish	8973
Herero	7290	Oriya	7982	Yoruba	8979
Hindi	7273	Oromo	7977	Zulu	9085
Hiri Motu	7279	Ossetian; Ossetic	7983		
Hrwatski	6779	Pali	8073		
Ido	7379	Panjabi	8065		
Interlingua (International)	7365	Persian	7065		
Interlingue	7365	Polski	8076		
Inuktitut	7385	Português	8084		

