

# Always there to help you

Register your product and get support at  
[www.philips.com/support](http://www.philips.com/support)

AJT3300



## User manual

# PHILIPS



# Contents

<b>1</b>	<b>Important</b>	<b>2</b>
	Know these safety symbols	2
<b>2</b>	<b>Your clock radio</b>	<b>3</b>
	Introduction	3
	What's in the box	3
	Overview of the clock radio	4
<b>3</b>	<b>Get started</b>	<b>5</b>
	Install battery	5
	Connect power	5
	Turn on	5
	Set time	6
<b>4</b>	<b>Listen to FM radio</b>	<b>7</b>
	Tune to FM radio stations	7
	Store FM radio stations in memory	7
	Select a preset radio station	7
<b>5</b>	<b>Use Bluetooth devices</b>	<b>8</b>
	Connect a device	8
	Play audio from Bluetooth-enabled device	8
	Clear the pairing information	8
	Control your phone call	9
<b>6</b>	<b>Other features</b>	<b>10</b>
	Charge your mobile devices	10
	Listen to an external device	11
	Set alarm timer	11
	Set sleep timer	12
	Adjust volume	12
<b>7</b>	<b>Product information</b>	<b>13</b>
	Specifications	13
<b>8</b>	<b>Troubleshooting</b>	<b>14</b>
	General	14
	About Bluetooth device	14
<b>9</b>	<b>Notice</b>	<b>15</b>
	Disposal of your old product and batteries	15

# 1 Important

## Know these safety symbols



This 'bolt of lightning' indicates uninsulated material within your unit may cause an electrical shock. For the safety of everyone in your household, please do not remove product covering.

The 'exclamation point' calls attention to features for which you should read the enclosed literature closely to prevent operating and maintenance problems.

**WARNING:** To reduce the risk of fire or electric shock, this apparatus should not be exposed to rain or moisture and objects filled with liquids, such as vases, should not be placed on this apparatus.

**CAUTION:** To prevent electric shock, match wide blade of plug to wide slot, fully insert.

### Warning

- Never remove the casing of this clock radio.
  - Never lubricate any part of this clock radio.
  - Never place this clock radio on other electrical equipment.
  - Keep this clock radio away from direct sunlight, naked flames or heat.
  - Make sure that you always have easy access to the power cord, plug or adaptor to disconnect the clock radio from the power:
- 
- Make sure that there is enough free space around the product for ventilation.
  - Battery usage **CAUTION** – To prevent battery leakage which may result in bodily injury, property damage, or damage to the product:

- Install the batteries correctly, + and - as marked on the product.
- Do not mix batteries (old and new or carbon and alkaline, etc.).
- Remove the batteries when the product is not used for a long time.
- The batteries shall not be exposed to excessive heat such as sunshine, fire or the like.
- Use only power supplies listed in the user manual.
- The product shall not be exposed to dripping or splashing.
- Do not place any sources of danger on the product (e.g. liquid filled objects, lighted candles).
- Where the plug of the Direct Plug-in Adapter is used as the disconnect device, the disconnect device shall remain readily operable.

## 2 Your clock radio

Congratulations on your purchase, and welcome to Philips! To fully benefit from the support that Philips offers, register your product at [www.philips.com/welcome](http://www.philips.com/welcome).

---

### Introduction

With this clock radio, you can

- play audio from Bluetooth-enabled devices, or other external devices;
- listen to FM radio;
- charge your mobile devices; and
- set two alarms to ring at different time.

---

### What's in the box

Check and identify the contents of your package.

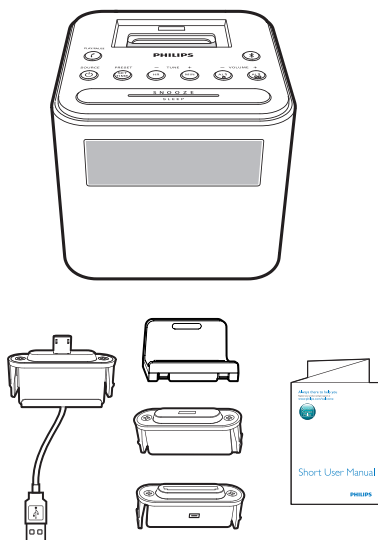

## Overview of the clock radio

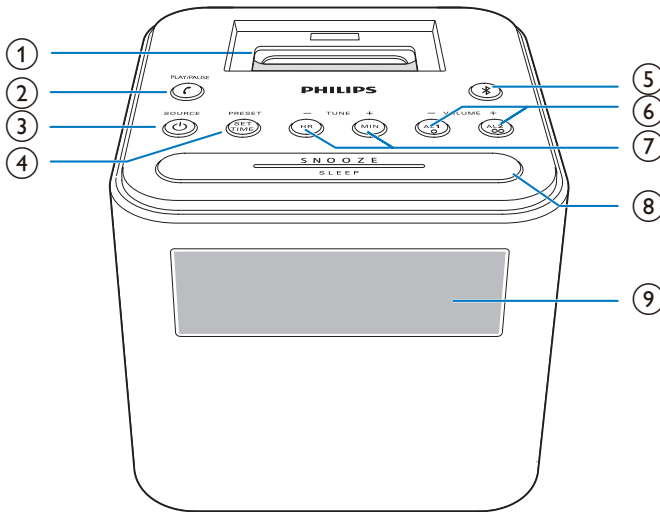

- ① Dock for charging mobile devices
- ② **⏮ PLAY/PAUSE**
  - Answer, reject, or end an incoming call.
  - In Bluetooth mode, start, pause, or resume play.
- ③ **⏻ SOURCE**
  - Turn on the clock radio.
  - Switch the clock radio to standby mode.
  - Select a source: Bluetooth, FM tuner, or Aux.
- ④ **⏴ PRESET/SET TIME**
  - Store radio stations in memory.
  - Select a preset radio station.
  - Set time.
- ⑤ **⌛**
  - Disconnect the Bluetooth-enabled device.
  - Enter Bluetooth pairing mode..
- ⑥ **⌚ AL1/AL2/- VOLUME +**
  - Set alarm.
  - Adjust volume.
- ⑦ **HR/MIN/- TUNE +**
  - Tune to FM radio stations.
  - Set hour and minute.
- ⑧ **SNOOZE/SLEEP**
  - Snooze alarm.
  - Set the sleep timer.
- ⑨ **Display panel**
  - Display current status.

# 3 Get started

Always follow the instructions in this chapter in sequence.

## Install battery

The batteries can only back up clock and alarm settings when AC power is disconnected.

### ! Caution

- The batteries contain chemical substances, so they should be disposed of properly.

- 1 Open the battery compartment.
- 2 Insert 2 AA batteries with correct polarity (+/-) as illustrated.
- 3 Close the battery compartment.

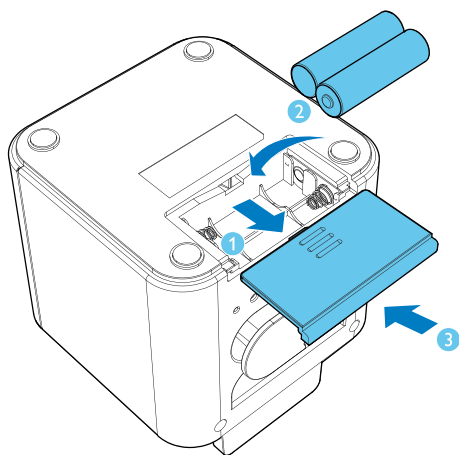

### \* Tip

- When the low battery indicator is displayed, replace the batteries.
- The display backlight is off when AC power is disconnected.

## Connect power

### ! Caution

- Risk of product damage! Make sure that the power voltage corresponds to the voltage printed on the back or underside of the clock radio.
- Risk of electric shock! When you unplug the AC adapter, always pull the plug from the socket. Never pull the cord.

Connect the AC power adaptor to the wall socket.

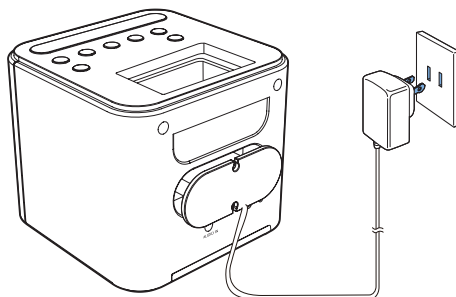

## Turn on

Press  $\odot$  to turn on the clock radio.

↳ The clock radio switches to the last selected source.

- To select another source, press  $\odot$  repeatedly to switch to Bluetooth, FM, or Aux mode.

## Switch to standby mode

- Press  $\odot$  again.
- In Bluetooth mode, if Bluetooth connection is invalid for 15 minutes or music playback is stopped after connection, this product switches to standby mode automatically.
- In Aux mode, if the audio-in cable is disconnected or music playback is stopped for 15 minutes, this product switches to standby mode automatically.

---

## Set time

 Note

- You can only set time in standby mode.

- 1** Press and hold **SET TIME** for two seconds to activate clock setting mode.  
↳ The hour and minute digits blink.
- 2** Press **HR** repeatedly to set hour.
- 3** Press **MIN** repeatedly to set minute.
- 4** Press **SET TIME** again to confirm.  
↳ The set time is displayed.

 Note

- The clock radio exits time setting mode when being idle for 10 seconds.



## 4 Listen to FM radio



### Note

- Keep the clock radio away from other electronic devices to avoid radio interference.
- For better reception, fully extend and adjust the position of the FM antenna.



### Tip

- To remove a pre-stored station, store another station in its place.

---

## Select a preset radio station

In tuner mode, press **PRESET** repeatedly to select a preset station.

---

## Tune to FM radio stations

- 1 Press **SOURCE** repeatedly to switch to FM tuner mode.
- 2 Press and hold **TUNE -** or **TUNE +** for 2 seconds.  
↳ The clock radio tunes to a station with strong reception automatically.
- 3 Repeat step 2 to tune to more radio stations.

### To tune to a station manually:

In tuner mode, press **TUNE -** or **TUNE +** repeatedly to select a frequency.

---

## Store FM radio stations in memory

You can store up to 10 FM radio stations.

- 1 Tune to an FM radio station.
- 2 Press and hold **PRESET** for two seconds.  
↳ The preset number begins to blink.
- 3 Press **TUNE -** or **TUNE +** to select a number.
- 4 Press **PRESET** again to confirm.
- 5 Repeat steps 1 to 4 to store other stations.

# 5 Use Bluetooth devices

With this clock radio, you can listen to audio from Bluetooth-enabled devices and control the incoming call through Bluetooth.

## Connect a device

### Note

- Make sure that your Bluetooth device is compatible with this product.
- Before pairing a device with this product, read its user manual for Bluetooth compatibility.
- This product can memorize a maximum of 4 paired devices.
- Make sure that Bluetooth function is enabled on your device, and your device is set as visible to all other Bluetooth devices.
- The operational range between this product and a Bluetooth device is approximately 10 meters (30 feet).
- Any obstacle between this product and a Bluetooth device can reduce the operational range.
- Keep away from any other electronic device that may cause interference.

- 1 Press **SOURCE** repeatedly to select Bluetooth mode.  
↳ **[BT]** (Bluetooth) flashes on the display.
- 2 On your Bluetooth device, enable Bluetooth and search for Bluetooth devices (refer to the user manual of the device).
- 3 When **[AJT3300]** is displayed on your device, select it to start pairing and connection. If necessary, enter default password "0000".  
↳ After successful pairing and connection, **[BT]** (Bluetooth) stops flashing, and the clock radio beeps twice.

### Note

- If your Bluetooth device has been paired with AJT3300 before, you just need to find out **[AJT3300]** on your Bluetooth menu, then start the connection.

### To disconnect the Bluetooth-enabled device:

- Press and hold **⌘** for 3 seconds;
- Disable Bluetooth on your device; or
- Move the device beyond the communication range.

### To connect another Bluetooth-enabled device:

- 1 Press and hold **⌘** for 3 seconds to disconnect the currently connected device.  
↳ The clock radio enters Bluetooth pairing mode.
- 2 Connect another Bluetooth device.

## Play audio from Bluetooth-enabled device

### Note

- If there is an incoming call on the connected mobile phone, music play pauses.

After successful Bluetooth connection, play audio on the Bluetooth device.

- ↳ Audio comes out from the clock radio.
  - You can press **PLAY/PAUSE** to start, pause or resume play.

---

## Control your phone call

After Bluetooth connection, you can control your incoming phone call with this product.

Button	Function
	Press to answer an incoming call. During a call, press to end the current call.
	Press and hold to reject an incoming call.

### Note

- Music play pauses when there is an incoming call.

## 6 Other features

### Charge your mobile devices

With this clock radio, you can charge your Android-powered mobile phone with a micro USB socket and Apple devices with a lightning or 30-pin connector.

- 1 Connect the clock radio with your mobile device.
  - For Android-powered mobile device with a micro USB socket: use the supplied cable to connect the product with the mobile device as illustrated;

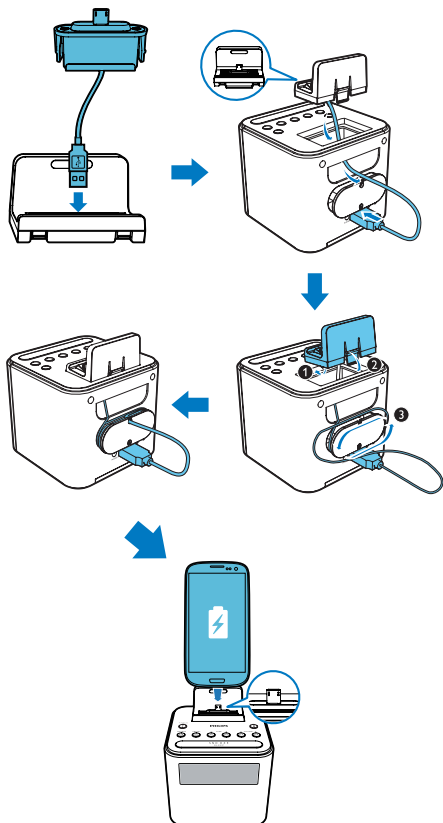

- For Apple devices with a lightning or 30-pin connector: use the charging cable of the Apple device (not supplied) to connect the product with the mobile device as illustrated;

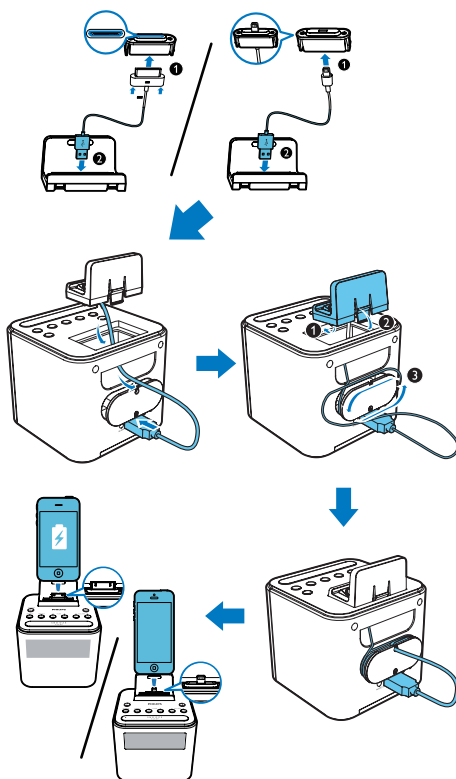

- 2 Connect the clock radio to AC power.  
↳ The mobile device begins to charge.

#### Note

- WOOX Innovations does not guarantee the compatibility of this product with all devices.

## Listen to an external device

With this clock radio, you can also listen to an external audio device such as an MP3 player.

- 1 Connect an audio input cable with a 3.5 mm connector on both ends to
  - the **AUDIO IN** socket on this speaker, and
  - the headphone socket on the external device.

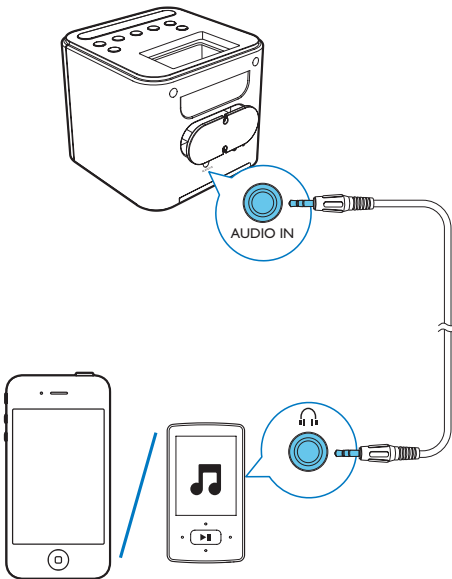

- 2 Press **SOURCE** repeatedly to select AUX source.
- 3 Play audio on the external device (refer to its user manual).

## Set alarm timer

You can set two alarms to ring at different time.

### Note

- You can only set alarm in standby mode.
- Make sure that you have set the clock correctly.

- 1 Press and hold **AL1** or **AL2** for two seconds to activate alarm setting mode.  
↳ The hour digits blink.
- 2 Press **HR** repeatedly to set the hour.
- 3 Press **MIN** repeatedly to set the minute.
- 4 Press **AL1** or **AL2** to confirm.
- 5 Press **HR** or **MIN** to set the alarm source: Buzzer or FM tuner.
- 6 Press **AL1** or **AL2** to confirm.

### Tip

- The clock radio exits alarm setting mode when being idle for 10 seconds.

## Activate or deactivate the alarm timer

- 1 Press **AL1** or **AL2** to view alarm settings.
- 2 Press **AL1** or **AL2** again to activate or deactivate the alarm timer.
  - ↳ If the alarm timer is activated, [**AL1**] or [**AL2**] is displayed.
  - ↳ If the alarm timer is deactivated, the alarm indicator disappears.
    - To stop the ringing alarm, press the corresponding **AL1/AL2**.
    - ↳ The alarm repeats ringing for the next day.



## Note

- If FM tuner is selected and you are listening to radio when alarm time comes, buzzer is activated automatically.
- When alarm sounds, volume increases gradually. You cannot adjust the alarm volume manually.

	Alarm source	Alarm duration
<b>AC power</b>	FM tuner or buzzer	30 minutes
<b>Battery power</b>	Buzzer	1 minute

## Snooze the alarm

When alarm sounds, press **SNOOZE**.

- ↳ The alarm snoozes and repeats ringing nine minutes later.

## Set sleep timer

- 1 Turn on the product.
- 2 Press **SLEEP** repeatedly to select a period (in minutes).
  - ↳ The clock radio switches to standby mode automatically after the preset period.

To deactivate the sleep timer:

- Press **SLEEP** repeatedly until **[OFF]** (off) appears.

15 → 30 → 60 → 90 → 120



## Adjust volume

While listening, press **-VOLUME +** to adjust volume.

# 7 Product information



## Note

- Product information is subject to change without prior notice.

## Specifications

### Amplifier

Total Output Power	2W
--------------------	----

### Tuner (FM)

Tuning Range	87.5-108 MHz
--------------	--------------

Tuning Grid	50 KHz
-------------	--------

Sensitivity

- Mono, 26 dB S/N Ratio	<22 dBf
-------------------------	---------

Total Harmonic Distortion	<3%
---------------------------	-----

Signal to Noise Ratio	>50 dBA
-----------------------	---------

### Bluetooth

Bluetooth Version	V3.0
-------------------	------

Supported Profiles	HFP, A2DP, AVRCP
--------------------	------------------

Range	10 m (Free space)
-------	-------------------

### General information

AC power (power adapter)	Brand name: Philips; Model: OH-1015A0551800U-CCC; Input: 100-240V~, 50/60 Hz, 350 mA; Output: 5.5 V $\equiv$ 1.8 A
--------------------------	--

USB Port	5 V $\equiv$ 1 A
----------	------------------

Operation Power Consumption	10 W
-----------------------------	------

Standby Power Consumption	<1 W
---------------------------	------

Dimensions:

- Main Unit (W x H x D)	112 x 101 x 125 mm
-------------------------	--------------------

Weight:

- Main Unit	0.5 kg
-------------	--------

# 8 Troubleshooting



## Warning

- Never remove the casing of this device.

To keep the warranty valid, never try to repair the system yourself.

If you encounter problems when using this device, check the following points before requesting service. If the problem remains unsolved, go to the Philips Web page ([www.philips.com/support](http://www.philips.com/support)). When you contact Philips, make sure that the device is nearby and the model number and serial number are available.

---

## General

### No power

- Make sure that the AC power adaptor of the unit is connected properly.
- Make sure that there is power at the AC outlet.

### No sound

- Adjust volume on the clock radio.
- Adjust volume on the Bluetooth-connected device.

### No response from the unit

- Disconnect and reconnect the AC power plug, then turn on the unit again.

### Cannot charge your mobile devices

- Make sure that the Apple device or Android-powered device is connected with the clock radio properly.
- Make sure that the clock radio is powered on.

### Poor radio reception

- Increase the distance between the product and other electrical appliances.
- Fully extend the antenna.

### Alarm does not work

- Set the clock/alarm correctly.

### Clock/alarm setting erased

- Power has been interrupted or the power plug has been disconnected.
- Reset the clock/alarm.

---

## About Bluetooth device

### The audio quality is poor after connection with a Bluetooth-enabled device.

- The Bluetooth reception is poor. Move the device closer to this product or remove any obstacle between them.

### Cannot connect with the device.

- The Bluetooth function of the device is not enabled. Refer to the user manual of the device for how to enable the function.
- This product is already connected with another Bluetooth-enabled device. Disconnect that device and then try again.

### The paired device connects and disconnects constantly.

- The Bluetooth reception is poor. Move the device closer to this product or remove any obstacle between them.
- For some devices, Bluetooth connection may be deactivated automatically as a power-saving feature. This does not indicate any malfunction of this product.



# 9 Notice

Any changes or modifications made to this device that are not expressly approved by WOOX Innovations may void the user's authority to operate the equipment.

---

## Disposal of your old product and batteries

Your product is designed and manufactured with high quality materials and components, which can be recycled and reused. Never dispose of your product with other household waste. Please inform yourself about the local rules on the separate collection of electrical and electronic products and batteries. The correct disposal of these products helps prevent potentially negative consequences on the environment and human health. Your product contains batteries, which cannot be disposed of with normal household waste. Please inform yourself about the local rules on separate collection of batteries. The correct disposal of batteries helps prevent potentially negative consequences on the environment and human health. Please visit [www.recycle.philips.com](http://www.recycle.philips.com) for additional information on a recycling center in your area.

### Environmental information

All unnecessary packaging has been omitted. We have tried to make the packaging easy to separate into three materials: cardboard (box), polystyrene foam (buffer) and polyethylene (bags, protective foam sheet.) Your system consists of materials which can be recycled and reused if disassembled by a specialized company. Please observe the local regulations regarding the disposal of packaging materials, exhausted batteries and old equipment.

The Bluetooth® word mark and logos are registered trademarks owned by Bluetooth SIG, Inc. and any use of such marks by WOOX Innovations is under license.

### Note

- The type plate is located on the bottom of the apparatus.



This is CLASS II apparatus with double insulation, and no protective earth provided.



Specifications are subject to change without notice.

2014 © WOOX Innovations Limited.

All rights reserved.

Philips and the Philips' Shield Emblem are registered trademarks of Koninklijke Philips N.V. and are used by WOOX Innovations Limited under license from Koninklijke Philips N.V.

AJT3300\_93\_UM\_V2.0

