

Register your product and get support at

[www.philips.com/welcome](http://www.philips.com/welcome)

DVP3560K



EN	User manual	3
MS-MY	Manual pengguna	21
ZH-HK	使用手冊	41

**PHILIPS**

# Contents

<b>1</b>	<b>Important</b>	4
	Safety and important notice	4
	Trademark notice	4
<b>2</b>	<b>Your DVD player</b>	5
	Playable media	5
	Product overview	5
<b>3</b>	<b>Connect</b>	6
	Connect audio/video cables	6
	Optional audio connections	7
	Connect USB flash drive	7
	Connect power	7
<b>4</b>	<b>Get started</b>	7
	Prepare the remote control	7
	Find the TV input channel	8
	Select menu display language	8
	Turn on progressive scan	8
	Use Philips EasyLink	9
<b>5</b>	<b>Play</b>	9
	Play a disc	9
	Play video	9
	Play music	11
	Play photo	11
	Play from a USB flash drive	12
<b>6</b>	<b>Other features</b>	12
	Create MP3 files	12
	Karaoke	13
<b>7</b>	<b>Adjust settings</b>	14
	General setup	14
	Audio setup	14
	Video setup	15
	Preferences	17
<b>8</b>	<b>Additional information</b>	18
	Update software	18
	Care	18
	Specifications	18
<b>9</b>	<b>Troubleshooting</b>	19
<b>10</b>	<b>Glossary</b>	20

# 1 Important

## Safety and important notice



### Warning

- Risk of overheating! Never install the product in a confined space. Always leave a space of at least 4 inches around the product for ventilation. Ensure curtains or other objects never cover the ventilation slots on the product.
- Never place the product, remote control or batteries near naked flames or other heat sources, including direct sunlight.
- Avoid high temperature, moisture, water and dust.
- This unit must not be exposed to dripping or splashing.
- Never place any object or items that can damage this unit (e.g., liquid filled objects, lighted candles).
- Never place this product on other electrical equipment.
- Keep away from this product during lightning storms.
- Where the mains plug or an appliance coupler is used as the disconnect device, the disconnect device shall remain readily operable.
- Visible and invisible laser radiation when open. Avoid exposure to beam.

## About Progressive Scan

Consumers should note that not all high definition television sets are fully compatible with this product and may cause artifacts to be displayed in the picture. In case of 525 or 625 progressive scan picture problems, it is recommended that the user switch the connection to the 'standard definition' output. If there are questions regarding our TV set compatibility with this model 525p and 625p DVD player, please contact our customer service center.

## Disposal of your old product and batteries

Your product is designed and manufactured with high quality materials and components, which can be recycled and reused.



Never dispose of your product with other household waste. Please inform yourself about the local rules on the separate collection of electrical and electronic products and batteries. The correct disposal of these products helps prevent potentially negative consequences on the environment and human health. Your product contains batteries, which cannot be disposed of with normal household waste. Please inform yourself about the local rules on separate collection of batteries. The correct disposal of batteries helps prevent potentially negative consequences on the environment and human health. Please visit [www.recycle.philips.com](http://www.recycle.philips.com) for additional information on a recycling center in your area.

## Copyright notice

This product incorporates copyright protection



**Be responsible  
Respect copyrights**

technology that is protected by U.S. patents and other intellectual property rights. Use of this copyright protection technology must be authorized by Macrovision, and is intended for home and other limited viewing uses only unless otherwise authorized by Macrovision. Reverse engineering or disassembly is prohibited.



## Trademark notice



'DVD Video' is a trademark of DVD Format/Logo Licensing Corporation.



**ABOUT DIVX VIDEO:** DivX® is a digital video format created by DivX, Inc. This is an official DivX Certified device that plays DivX video. Visit [www.divx.com](http://www.divx.com) for more information and software tools to convert your files into DivX video.  
**ABOUT DIVX VIDEO-ON-DEMAND:** This DivX Certified® device must be registered in order to play DivX Video-on-Demand (VOD) content. To generate the registration code, locate the DivX VOD section in the device setup menu. Go to [vod.divx.com](http://vod.divx.com) with this code to complete the registration process and learn more about DivX VOD. DivX®, DivX Certified® and associated logos are registered trademarks of DivX, Inc. and are used under license.



Manufactured under license from Dolby Laboratories. Dolby and the double-D symbol are trademarks of Dolby Laboratories.



The USB-IF Logos are trademarks of Universal Serial Bus Implementers Forum, Inc.

## 2 Your DVD player

Congratulations on your purchase, and welcome to Philips! To fully benefit from the support that Philips offers, register your product at [www.philips.com/welcome](http://www.philips.com/welcome).

### Playable media

This product can play:

- DVD, DVD-Video, DVD+R/+RW, DVD-R/-RW, DVD+R/-R DL (Dual Layer)
- Video CD/SVCD
- Audio CD, CD-R/CD-RW
- MP3 media, WMA media, DivX (Ultra) media, JPEG files
- USB flash drive

### Region codes





You can play discs with the following region codes.

DVD region code	Countries
	Asia Pacific, Taiwan, Korea

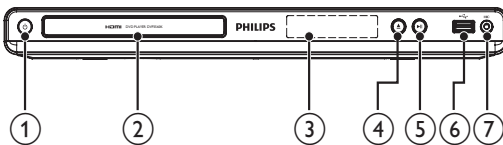
### Product overview

#### Main Unit





- 1**  (Standby-On)
  - Turn on the DVD player or switch to standby mode.
- 2** **Disc compartment**
- 3** **Display panel**
- 4**  (Open/Close)
  - Open or close the disc compartment.
- 5**  (Play/Pause)
  - Start, pause or resume disc play.
- 6**  (USB) jack
  - Connect a USB flash drive.

- 7** **MIC**
  - Connect a microphone.

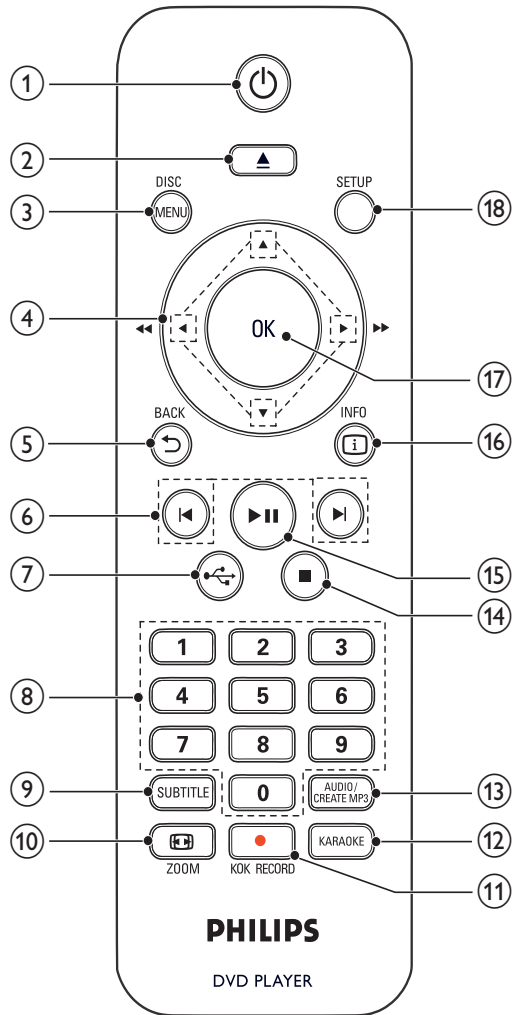
### Remote control



- 1** 
  - Turn on the unit or switch to standby.
- 2** 
  - Open or close the disc compartment.
- 3** **DISC MENU**
  - Access or exit the disc menu.
  - Switch to the disc mode.
  - During a photo slideshow, switch between the Fun Mode (color) and Simple Mode (black and white).
  - For VCD and SVCD, turn on or off PBC (playback control).

- ④ ▲▼◀▶
  - Navigate the menus.
  - Search fast-forward (▶) or fast-backward (◀).
  - Search slow-forward (▲) or slow-backward (▼).
- ⑤ ↶ BACK
  - Return to the previous display menu.
- ⑥ ⏮▶
  - Skip to the previous or next title, chapter, or track.
- ⑦ 🔌
  - Switch to the USB mode.
- ⑧ **Numeric buttons**
  - Select an item to play.
- ⑨ **SUBTITLE**
  - Select a subtitle language on a disc.
- ⑩ 📺 ZOOM
  - Fit the picture display to the TV screen.
  - Zoom the picture in or out.
- ⑪ ● KOK RECORD
  - Record the voice and music during karaoke into a USB flash drive.
- ⑫ **KARAOKE**
  - Access or exit the Karaoke setup menu.
- ⑬ **AUDIO/CREATE MP3**
  - Select an audio language or channel on a disc.
  - Access the menu of creating MP3 files.
- ⑭ ■
  - Stop play.
- ⑮ ▶⏸
  - Start, pause or resume disc play.
- ⑯ ⓘ INFO
  - For discs, access the play options or display the current disc status.
  - For slideshows, display a thumbnail view of photo files.
- ⑰ OK
  - Confirm an entry or selection.
- ⑱ **SETUP**
  - Access or exit the setup menu.

## 3 Connect

Make the following connections to use this product.

### Basic connections:

- Video
- Audio

### Optional connections:

- Route audio to other devices:
  - Digital amplifier/receiver
  - Analogue stereo system
- USB flash drive

## Connect audio/video cables

Select the best video connection that TV can support.

- **Option 1:** Connect to the HDMI jack (for a HDMI, DVI or HDCP-compliant TV).
- **Option 2:** Connect to the component video jacks (for a standard TV or Progressive Scan TV).
- **Option 3:** Connect to the composite video jack (for a standard TV).

### Option 1: Connect to the HDMI jack

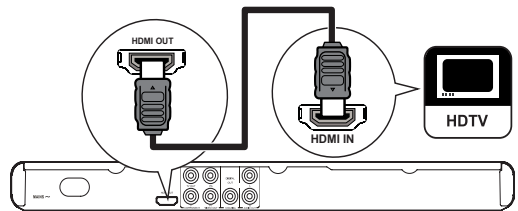

- 1 Connect an HDMI cable (not supplied) to:
  - the **HDMI OUT** jack on this product.
  - the HDMI input jack on the TV.

### Note

- If the device supports HDMI CEC, you can control compliant devices with a single remote control (see "Get started" > "Use Philips EasyLink").

### Option 2: Connect to the component video jacks

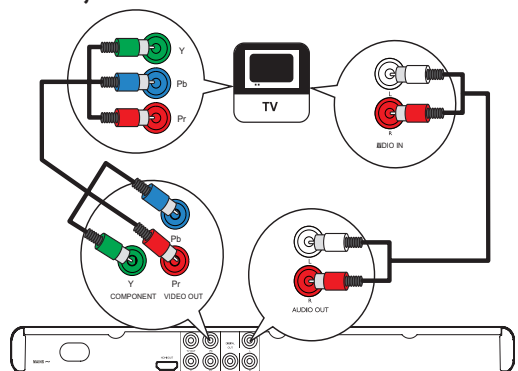

- 1 Connect the component video cables (not supplied) to:
  - the **Y Pb Pr** jacks on this product.

- the COMPONENT VIDEO input jacks on the TV.
- 2 Connect the audio cables (supplied) to:
    - the **AUDIO OUT L/R** jacks on this product.
    - the audio input jacks on the TV.

### Option 3: Connect to the video (CVBS) jack

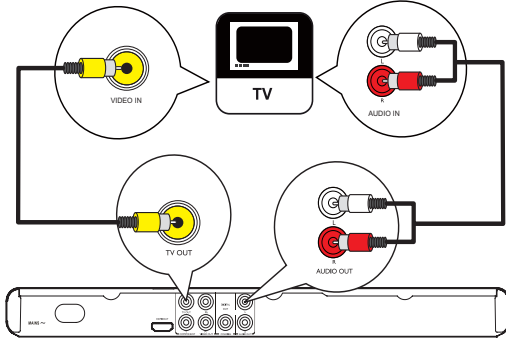

- 1 Connect a composite video cable (supplied) to:
  - the **TV OUT** jack on this product.
  - the video input jack on the TV.
- 2 Connect the audio cables (supplied) to:
  - the **AUDIO OUT L/R** jacks on this product.
  - the audio input jacks on the TV.

## Optional audio connections

Connect the audio from this product to other devices to enhance sound.

### Connect to digital amplifier/receiver

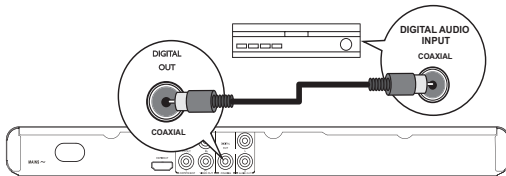

- 1 Connect a coaxial cable (not supplied) to:
  - the **COAXIAL** jack on this product.
  - the COAXIAL/DIGITAL input jack on the device.

### Connect analogue stereo system

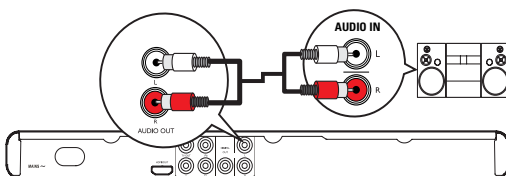

- 1 Connect the audio cables (supplied) to:
  - the **AUDIO OUT L/R** jacks on this product.
  - the audio input jacks on the device.

## Connect USB flash drive

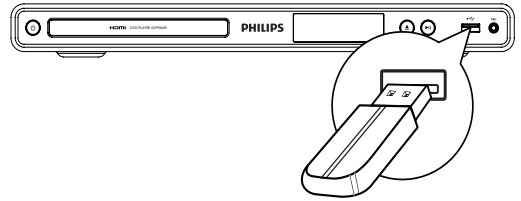

- 1 Connect a USB flash drive to the  jack on this product.

### Note

- This product can only play/view MP3, WMA, DivX (Ultra) or JPEG files that are stored on a USB flash drive.
- Press the  button to access the content and play the files.

## Connect power

### ! Caution

- Risk of product damage! Ensure that the power supply voltage corresponds to the voltage printed on the back of the unit.
- Before connecting the AC power cord, ensure you have completed all other connections.

### Note

- The type plate is located on the back of the product.

- 1 Connect the AC power cable to:
  - this product.
  - the wall socket.
 ↳ This product is ready to be set up for use.

# 4 Get started

## Prepare the remote control

- 1 Press and push the battery compartment to slide it open (see "1" in the illustration).
- 2 Insert two AAA batteries with correct polarity (+/-) as indicated.
- 3 Push and slide back the battery compartment (see "3" in the illustration).

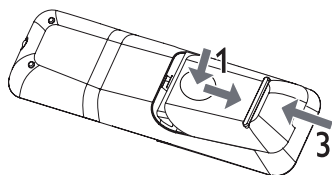

### Note

- If you are not going to use the remote control for a long time, remove the batteries.
- Do not mix batteries (old and new or carbon and alkaline, etc.).
- Batteries contain chemical substances, so they should be disposed of properly.

## Find the TV input channel

- 1 Press **⏻** to turn on this product.
- 2 Turn on the TV and switch to the video input channel (refer to the TV user manual on how to select the A/V input channel).

## Select menu display language

### Note

- If this product is connected to a HDMI CEC compliant TV, skip this setting. It switches automatically to the same OSD menu language as per your TV setting (if the language set on TV is supported by this product).

General Setup		
	Disc Lock	<input type="radio"/> Auto (ENG)
	OSD Language	<input type="radio"/> English
	Sleep Timer	<input type="radio"/> 中文(繁體)
	Auto Standby	<input type="radio"/> ไทย
	DivX(R) VOD Code	<input type="radio"/> 한국어
		<input type="radio"/> Melayu

- 1 Press **SETUP**.  
↳ **[General Setup]** menu is displayed.
- 2 Select **[OSD Language]**, and then press **▶**.
- 3 Press **▲▼** to select a language, and then press **OK**.

## Turn on progressive scan

### Note

- To use the progressive scan feature, you must connect a progressive scan TV with the component video jacks (see "Connect" > "Connect audio/video cables" > "Option 2: Connect to the component video jacks" for details).

Video Setup		
	TV System	<input type="radio"/> On
	TV Display	<input type="radio"/> Off
	<b>Progressive</b>	
	Picture Setting	
	My Wallpaper	
	HD JPEG	
	HDMI Setup	

- 1 Turn on the TV to the correct video input channel for this product.
- 2 Press **SETUP**.
- 3 Press **▼** to select **[Video Setup]**.
- 4 Select **[Progressive]** > **[On]**, and then press **OK**.  
↳ A warning message is displayed.
- 5 To proceed, select **[OK]** and then press **OK**.  
↳ The progressive setup is complete.

### Note

- If a blank/distorted screen is displayed, wait for 15 seconds for the auto recovery.
- If no picture is displayed, turn off the progressive scan mode as follows:
  - 1) Press **▲** to open the disc compartment.
  - 2) Press the **Numeric button '1'**.

- 6 Press **SETUP** to exit the menu.
- 7 You can now turn on the progressive scan mode on the TV (see the TV user manual).

### Note

- During play, when the progressive scan mode is on for both this product and the TV, distorted picture may display. In this case, turn off the progressive scan feature on both this product and the TV.

## Use Philips EasyLink

This product supports Philips EasyLink which uses the HDMI CEC (Consumer Electronics Control) protocol. You can use one single remote control to control EasyLink-compliant devices that are connected through HDMI connectors.

### Note

- To enable the EasyLink feature, you must turn on the HDMI CEC operations on the TV and on other devices connected to TV. Refer to the TV's/devices manual for details.

## One-touch play

- Press  to turn on this product.
  - The TV (if supports one-touch play) automatically turns on and switches to the correct video-in channel.
  - If a disc is loaded in this product, disc play automatically starts.

## One-touch standby

- Press and hold  on the remote control for more than 3 seconds.
  - All the connected devices (if the device supports one-touch standby) automatically switch to standby.

### Note



- Philips does not guarantee 100% interoperability with all HDMI CEC devices.

# 5 Play

## Play a disc

### Caution

- Do not place any objects other than discs into the disc compartment.
- Do not touch the disc optical lens inside the disc compartment.

- Press  to open the disc compartment.
- Insert a disc with its label facing up.
- Press  to close the disc compartment and start disc play.

### Note

- Check the types of discs supported (see "Your DVD player" > "Playable media").
- If the password entry menu is displayed, enter the password before you can play the locked or restricted disc (see "Adjust settings" > "Preferences" > **[Parental Control]**).









## Play video

### Note

- Some operations may not work with some discs. See the information accompanying the disc for details.

## Control video play

- Play a title.
- Use the remote control to control the play.

Button	Action
	Start, pause or resume disc play.
	Stop disc play.
	Skip to a previous/next title or chapter.
	Search fast-backward or fast-forward. Press repeatedly to change the search speed.
	Search slow-forward or slow-backward. Press repeatedly to change the search speed. For VCD/SVCD, slow-backward search is not available.
<b>AUDIO/ CREATE MP3</b>	Select an audio language or channel available on a disc.
<b>SUBTITLE</b>	Select a subtitle language available on a disc.
 <b>ZOOM</b> (Screen fit)	Fit the picture format to the TV screen. Press repeatedly until the image is scaled to fit to the TV screen.
 <b>ZOOM</b>	Toggle between screen aspect ratio and different zoom factor. To pan through the zoomed image, press the <b>Navigation buttons</b> .
 <b>INFO</b>	Access the play options and display the current disc status.



---

## Access DVD menu

- 1 Press **DISC MENU** to access the disc root menu.
- 2 Select a play option, then press **OK**.
  - In some menus, press the **Numeric buttons** to input your selection.

---

## Access VCD menu

The PBC (playback control) feature is available for VCD/SVCD, which can display the contents menu for you to select a play option. The PBC is on by default in the factory.

 **Note**

- See "Adjust settings" > "Preferences" > **[PBC]** on how to turn PBC on or off.

- 1 Display the contents menu via one of the following ways:
  - If PBC is on, load in a VCD/SVCD.
  - During play with PBC on, press **↩ BACK**.
- 2 Press the **Numeric buttons** to select a play option, and then press **OK** to start play.
  - If PBC is turned off, it skips the menu display and starts play from the first track.

---

## Preview disc contents

- 1 During play, press **ⓘ INFO**.
  - ↳ The disc status menu is displayed.
- 2 Select **[Preview]**, and then press **▶**.
- 3 Select a preview option, and then press **OK**.
  - ↳ A thumbnails preview screen is displayed.
    - To go to the next/previous preview screen, select **[Prev]** or **[Next]**, and then press **OK**.
    - To start play, press **OK** at the selected thumbnail picture.

---

## Skip play to a specific time

- 1 During play, press **ⓘ INFO**.
  - ↳ The disc status menu is displayed.
- 2 Select an option for the current elapsed playing time, and then press **▶**.
  - **[TT Time]** (title time)
  - **[CH Time]** (chapter time)
  - **[Disc Time]**
  - **[Track Time]**
- 3 Press the **Numeric buttons** to enter the time to skip to, then press **OK**.

---

## Display play time

- 1 During play, press **ⓘ INFO**.
  - ↳ The disc status menu is displayed.
- 2 Select **[Time Disp.]**, and then press **▶**.
  - ↳ The display options vary from disc type.
- 3 Select an option, and then press **OK**.

---

## View DVD play from different angles

- 1 During play, press **ⓘ INFO**.
  - ↳ The disc status menu is displayed.
- 2 Select **[Angle]**, and then press **▶**.
- 3 Press the **Numeric buttons** to change the angle.
  - ↳ Play changes to the selected angle.

 **Note**

- Applicable only to discs that contain multi-angle scenes.

---

## Repeat play for a specific section

- 1 During play, press **ⓘ INFO**.
- 2 Press **▼** to select **[REPEAT AB]**.
- 3 Press **OK** to set the start point.
- 4 Press **OK** to set the end point.
  - ↳ Repeat play starts.
    - To cancel repeat play, press **OK** again.

 **Note**

- The marked section for repeat play is only possible within a track/title.

---

## Play DivX® (Ultra) video

DivX® (Ultra) video is a digital media format that retains high quality despite a high rate of compression. You can enjoy DivX® (Ultra) video on this DivX (Ultra) certified product.

- 1 Insert a disc or USB flash drive that contains the DivX (Ultra) videos.
  - For USB, press **⏪**.
  - ↳ A contents menu is displayed.
- 2 Select a title to play, then press **OK**.
  - You may select subtitle/audio language.

 **Note**

- You can only play DivX (Ultra) video that is rented or purchased with the DivX registration code of this product (see "Adjust Settings" > **[General Setup]** > **[DivX(R) VOD Code]**).

## Play music

### Control a track

- 1 Play a track.
- 2 Use the remote control to control the play.

Button	Action
	Start, pause or resume disc play.
	Stop disc play.
	Skip to a previous/next track.
	Select an item to play.
	Searches fast-backward or fast-forward. Press repeatedly to change the search speed.

### Quick skip play

- 1 During play, press **INFO** repeatedly to select an option.

Display	Action
[Disc Go To]	Skip play to a specific time within the disc.
[Track Go To]	Skip play to a specific time within a track.
[Select Track]	Skip play to a specific track number.

- 2 Press the **numeric buttons** to change the time/number to skip to.

### Play MP3/WMA music

MP3/WMA is a type of highly compressed audio file (files with .mp3, .wma extensions).

- 1 Insert a disc or USB flash drive that contains the MP3/WMA music.
  - For USB, press .
  - ↳ A contents menu is displayed.
- 2 If play does not automatically start, select a track to play.
  - To select another track/folder, press , then press **OK**.



### Note

- For disc recorded in multiple sessions, only the first session is played.
- For a WMA file that is protected by Digital Rights Management (DRM), it cannot be played on this product.
- This product does not support MP3PRO audio format.
- For any special character that is present in the MP3 track name (ID3) or album name, it might not be displayed correctly on the screen because these characters are not supported.
- Folders/files that exceed the supported limit of this product cannot be displayed or played.

### Repeat play for a specific section

For audio CDs,

- 1 During play, press **INFO** repeatedly until [Off] is displayed.
- 2 Press to select a repeat option.

For MP3/WMA files,

- 1 During play, press **INFO** repeatedly to select a repeat option.

## Play photo

### Play photo as slideshow

You can play JPEG photos (files with .jpeg or .jpg extensions).

- 1 Insert a disc or USB flash drive that contains the JPEG photos.
  - For USB, press .
  - ↳ Slideshow begins (for Kodak disc), or a contents menu (for JPEG disc) is displayed.
- 2 Select a photo, and then press **OK** to start slideshow.
  - ↳ For a photo recorded with the "exif" format, the display orientation is automatically optimized.
  - To display photos in color (fun mode) or in black and white (simple mode), press **DISC MENU**.
  - To preview the photos in thumbnail, press **INFO**.
    - To select a photo, press the **Navigation buttons**.
    - To enlarge the selected photo and start slideshow, press **OK**.
    - To return to the menu, press **BACK**.

## Note

- It may require longer time to display the disc content on the TV due to the large number of songs/photos compiled onto one disc/USB flash drive.
- If the JPEG photo is not recorded with an 'exif' type file, the actual thumbnail picture cannot be shown on the screen. It is replaced by a 'blue mountain' thumbnail picture.
- This product can only display digital camera pictures according to the JPEG-EXIF format, typically used by almost all digital cameras. It cannot display Motion JPEG, or pictures in formats other than JPEG, or sound clips associated with pictures.
- Folders/files that exceed the supported limit of this product cannot be displayed or played.

## Control photo play

- 1 Play a photo slideshow.
- 2 Use the remote control to control the play.

Button	Action
◀/▶	Rotate a photo anti-clockwise/clockwise.
▲/▼	Rotate a photo horizontally/vertically.
🔍 ZOOM	Zoom in or out of a photo. Play pauses in zoom mode.
■	Stop a play.

## Play musical slideshow

Create a musical slideshow to play MP3/WMA music files and JPEG photo files simultaneously.

## Note



- To create a musical slideshow, you must store the MP3/WMA and JPEG files on the same disc/USB flash drive.

- 1 Play MP3/WMA music.
- 2 Press **↩** BACK to return to the main menu.
- 3 Navigate to the photo folder/album and press **OK** to start slideshow play.
  - ↳ Slideshow begins and continues till the end of the photo folder or album.
  - ↳ Audio continues to play until the end of the disc.
    - To stop slideshow play, press **■**.
    - To stop music play, press **■** again.

## Play from a USB flash drive

## Note

- This product plays/views MP3, WMA, DivX (Ultra) or JPEG files that are stored on a USB flash drive.

- 1 Connect a USB flash drive to the  jack on this product.
- 2 Press the  button.
  - ↳ A contents menu is displayed.
- 3 If play does not start automatically, select a file to play.
  - For more information, see the chapters "Play music", "Play photo" and "Play video" for details.
- 4 To stop play, press **■**.
  - To switch to the disc mode, press the  button.

## 6 Other features

### Create MP3 files

With this product, you can convert audio CDs into MP3 audio files. The created MP3 audio files are saved in the USB flash drive.

- 1 Insert an audio CD.
- 2 Connect a USB flash drive to the  jack on this product.
- 3 During disc play, press **AUDIO/CREATE MP3**.
  - ↳ The MP3 creation menu is displayed.
- 4 Select **[Yes]** in the menu, and then press **OK**.

Create MP3			
OPTIONS		TRACK	
Speed	Normal	<input type="radio"/> Track01	04:14
Bitrate	128kbps	<input type="radio"/> Track02	04:17
CRT ID3	Yes	<input type="radio"/> Track03	03:58
Device	USB 1	<input type="radio"/> Track04	04:51
SUMMARY		<input type="radio"/> Track05	03:53
Press [OK] button to change speed.		<input type="radio"/> Track06	04:09
		<input type="radio"/> Track07	04:38
Start	Exit	Select all	Deselect all

- 5 Select a conversion option in the **[OPTIONS]** panel, and then press **OK** repeatedly to select an item.

Option	Description
[Speed]	Select a copying speed.
[Bitrate]	Select a quality level. Higher bitrate for better sound quality and bigger file size.
[CRT ID3]	Copy track information into the MP3 file.
[Device]	The created files can only be saved in a USB flash drive.

- 6 Press **▶** to access the **[TRACK]** panel.
- 7 Select an audio track, and then press **OK**.
  - To select another track, repeat step 7.
  - To select all tracks, select **[Select all]** in the menu, and press **OK**.
  - To deselect all tracks, select **[Deselect all]** in the menu, and press **OK**.
- 8 Select **[Start]** in the menu, and then press **OK** to start to convert.
  - ↳ Once complete, a new folder is created automatically in the USB flash drive to store all the new MP3 files.
  - To exit the menu, select **[Exit]**, and then press **OK**.

#### Note

- When you convert, never press any button.
- DTS CDs and copy-protected CDs cannot be converted.
- Writer-protected or password-protected USB flash drives cannot be used to store MP3 files.

## Karaoke

You can connect a microphone (not supplied) to sing along with a music source.

#### Note

- Before you connect a microphone, set the microphone volume to the minimum to prevent howling.

- 1 Turn on the TV, and select the TV input channel.
- 2 Connect a microphone to the **MIC** jack on this product.
- 3 Turn on the microphone sound output (see "**Adjust Karaoke settings**").
- 4 Play a Karaoke disc and sing through the microphone.

## Adjust Karaoke settings

#### Note

- You need to turn on the microphone sound output in the **[Microphone]** option to activate karaoke-related menu options.

- 1 Press **KARAOKE**.
  - ↳ The karaoke settings menu is displayed.
- 2 Select an option, and then press **OK**.
- 3 Change or set a setting, and then press **OK**.
- 4 Press **KARAOKE** again to exit the menu.

**[Microphone]** - Turn on or off the microphone sound output.

**[MIC Volume]** - Adjust the microphone volume.

**[Echo]** - Adjust the echo level.

**[Karaoke Scoring]** - Turn off the function of Karaoke scoring or select a scoring level (basic/intermediate/advance). If a level is selected, the score is displayed after each song ends.

**[Karaoke Idol]** - Song contest among 4 singers.

- 1) In the **[Karaoke Scoring]** option, select a level (basic/intermediate/advance).
- 2) In the **[Karaoke Idol]** option, turn on the contest.
  - ↳ The song selection menu is displayed.
- 3) Input a track (VCD/SVCD) or a title/chapter (DVD) as the first song. Up to 4 songs can be selected.
- 4) Then select **[Start]**, and press **OK** to start play selected songs.
  - ↳ After all the selected songs end, a contest result is displayed.

**[Key Shift]** - Adjust the pitch level that matches your voice.

**[Vocal]** - Select various Karaoke audio modes, or turn off original vocal.

## Record Karaoke

You can record your singing into a USB flash drive. Each time you can record one song, and all the recorded songs are saved in .mp3 format.

At the first time when you record to a USB flash drive, a folder named "PHILIPS" is automatically created to save the recorded files.

#### Note

- This product supports recording to MAS USB devices (MTP/NAS devices are excluded).





- 1 During Karaoke, press **KOK RECORD** to display the record menu:
  - [Start at current time]** - start recording immediately.
  - [Start from beginning]** - start recording from the beginning of the current song.
    - To exit without recording, press again **KOK RECORD**.
- 2 Press **▲▼** to select an option, and press **OK**.
  - ↳ The recording begins, and a recording progress bar is displayed.
  - ↳ When the current song ends, the recording completes and stops.
  - ↳ During recording, you may press **KOK RECORD** and follow the on-screen instructions to stop the recording.

## 7 Adjust settings

### Note

- If the setup option is grayed out, it means the setting cannot be changed at the current state.

### General setup

General Setup		
	Disc Lock	_____
	OSD Language	_____
	Sleep Timer	_____
	Auto Standby	_____
	DivX(R) VOD Code	_____
		_____

- 1 Press **SETUP**.
  - ↳ **[General Setup]** menu is displayed.
- 2 Press **▶** to enter the submenu.
- 3 Select an option, and then press **OK**.
- 4 Select a setting, and then press **OK**.
  - To return to the previous menu, press **↶ BACK**.
  - To exit the menu, press **SETUP**.

#### [Disc Lock]

Set the play restriction for a disc which is loaded in the disc compartment (maximum 20 discs can be locked).

- **[Lock]** - Restrict the access to the current disc. At the next time when you want to play

this disc or unlock it, you need to enter the password.

- **[Unlock]** - Play all discs.

#### [OSD Language]

Select a language for on-screen menu.

#### [Sleep Timer]

Switch automatically to standby at the preset time.

- **[Off]** - Disable sleep mode.
- **[15 Mins], [30 Mins], [45 Mins], [60 Mins]** - Select the countdown time for this product to switch to standby.

#### [Auto Standby]

Turn on/off the auto standby mode.

- **[On]** - Switch to standby after 15 minutes of inactivity (for example, in pause or stop mode).
- **[Off]** - Disable the auto standby mode.

#### [DivX(R) VOD Code]





Display the DivX® registration code and deregistration code.

- **[Registration]** - Obtain a registration code to register this product on website.
- **[Deregistration]** - Obtain a deregistration code to cancel the registration of this product on website.

### Note

- Use this product's DivX registration code when you rent or purchase video from [www.divx.com/vod](http://www.divx.com/vod). The DivX videos rented or purchased through the DivX® VOD (Video On Demand) service can be played only on the device to which it is registered.

### Audio setup

Audio Setup		
	Analogue Output	_____
	Digital Audio	_____
	HDMI Audio	_____
	Audio Sync	_____
	Volume	_____
	Sound Mode	_____
	CD Upsampling	_____
	Night Mode	_____

- 1 Press **SETUP**.
  - ↳ **[General Setup]** menu is displayed.
- 2 Press **▼** to select **[Audio Setup]**, and then press **▶** to enter the submenu.
- 3 Select an option, and then press **OK**.
- 4 Select a setting, and then press **OK**.

- To return to the previous menu, press **↩ BACK**.
- To exit the menu, press **SETUP**.

### [Analogue Output]

Select an analogue setting based on the audio device that is connected through the analogue audio jack.

- **[LT/RT]** - For the surround sound output through two speakers.
- **[Stereo]** - For the stereo output.

### [Digital Audio]

Select a digital setting based on the digital amplifier/receiver that is connected through the digital jack (coaxial/digital).

- **[Digital Output]** - Select a type of digital output.
  - **[All]** - Support multi-channel audio formats.
  - **[Off]** - Disable digital output.
  - **[PCM Only]** - Downmix to two-channel audio format.
- **[LPCM Output]** - Select the LPCM (Linear Pulse Code Modulation) output sampling rate.
  - **[48kHz]** - For discs recorded at sampling rate of 48 kHz.
  - **[96kHz]** - For discs recorded at sampling rate of 96 kHz.

#### Note

- **[LPCM Output]** setting is only available if the **[Digital Output]** is set to **[PCM Only]**.
- The higher the sampling rate, the better the sound quality.

### [HDMI Audio]

Select the HDMI audio setting when you connect this product and the TV with an HDMI cable.

- **[On]** - Allow audio output through the TV and the speaker system. If the audio format on the disc is not supported, it will be downmixed to two-channel sound (linear-PCM).
- **[Off]** - Disable the audio output from HDMI devices connected to this player.

### [Audio Sync]

Set the delay time for audio output when you play a video disc.

1. Press **OK**.
2. Press **◀▶** to set the delay time.
3. Press **OK** to confirm and exit.

### [Volume]

Set the default volume level when you play a disc.

1. Press **OK**.
2. Press **◀▶** to set the volume.
3. Press **OK** to confirm and exit.

### [Sound Mode]

Select a preset sound effect to enhance the audio output.

- **[3D]** - Select a virtual surround sound effect that is produced from the left and right audio channels.
- **[Movie Mode]** - Select a sound effect for movies.
- **[Music Mode]** - Select a sound effect for music.

### [CD Upsampling]

For better sound quality in stereo mode, convert the music CD to a higher sampling rate.

- **[Off]** - Turn off CD-upsampling.
- **[88.2kHz]** - Convert to twice the original sampling rate.
- **[176.4kHz]** - Convert to four times the original sampling rate.

### [Night Mode]







Make loud sound level softer and soft sound level louder so that you can watch the DVD movies at a low volume, without disturbing others.

- **[On]** - Enjoy quiet viewing at night.
- **[Off]** - Enjoy surround sound with a full dynamic range.

#### Note

- Applicable only to Dolby Digital encoded DVDs.

## Video setup

Video Setup	
	TV System
	TV Display
	Progressive
	Picture Setting
	My Wallpaper
	HD JPEG
	HDMI Setup

- 1 Press **SETUP**.  
↳ **[General Setup]** menu is displayed.
- 2 Press **▼** to select **[Video Setup]**, and then press **▶** to enter the submenu.
- 3 Select an option, and then press **OK**.

- 4 Select a setting, and then press **OK**.
  - To return to the previous menu, press **↩ BACK**.
  - To exit the menu, press **SETUP**.

#### [TV System]

Change this setting if the video does not appear correctly. By default, this setting matches the most common setting for TVs in your country.

- **[PAL]** - For a PAL-system TV.
- **[Multi]** - For TV that is compatible with both PAL and NTSC.
- **[NTSC]** - For an NTSC-system TV.

#### [TV Display]

Select a display format:



- **[4:3 Pan Scan]** - For a 4:3 screen TV: full-height display with the trimmed sides.
- **[4:3 Letter Box]** - For a 4:3 screen TV: wide-screen display with black bars on the top and bottom of the screen.
- **[16:9]** - For a wide-screen TV: display ratio 16:9.

#### [Progressive]

If a progressive scan TV is connected to this product, turn on the progressive scan mode.

- **[On]** - Turn on progressive scan.
- **[Off]** - Turn off progressive scan mode.



#### Note

- For more detailed description, see "Get started" > "Turn on progressive scan".

#### [Picture Setting]

Select a predefined set of picture color settings or customize the personal setting.

- **[Standard]** - Original color setting.
- **[Bright]** - Vibrant color setting.
- **[Soft]** - Warm color setting.
- **[Personal]** - Customize the color setting. Set the level of brightness, contrast, sharpness and color saturation, then press **OK**.

#### [My Wallpaper]

Select a picture as the wallpaper.

- **[Default picture]** - The default wallpaper preset as the Philips logo.
- **[Saved picture]** - A captured video image or JPEG photo.

- **[Current picture]** - Capture a video image or JPEG photo and save it on the product.

- 
1. Play a video or photo slideshow.
  2. Select a video image or photo: press **▶||** to pause, and then press **SETUP**.
  3. Navigate to the option (**[Video Setup]** > **[My Wallpaper]** > **[Current picture]**).
  4. Press **OK** to confirm.

↳ One video image or JPEG photo is saved as wallpaper.

↳ A newly saved image or photo replaces the earlier one.

---

#### [HD JPEG]

Enjoy untouched and uncompressed JPEG pictures at its original resolution when you connect this product and the TV with an HDMI cable.

- **[On]** - Display high definition picture.
- **[Off]** - Display standard picture.

#### [HDMI Setup]

When you connect this product and the TV with an HDMI cable, select the best HDMI setup that the TV can support.

- **[Resolution]** - Select a video resolution that is compatible with the TV display capability.
  - **[Auto]** - Detect and select the best supported video resolution automatically.
  - **[480i], [480p], [576i], [576p], [720p], [1080i], [1080p]** - Select a video resolution that is best supported by the TV. See the TV manual for details.
- **[HDMI Deep Color]** - This feature is available only when the TV is connected by an HDMI cable, and when the TV supports deep color feature.
  - **[Auto]** - Enjoy vivid images in over a billion colors on a Deep Color enabled TV.
  - **[Off]** - Output the standard 8-bit color.
- **[Wide Screen Format]** - Define the wide screen format for disc play.
  - **[Super Wide]** - Center position of the screen is stretched less than the side (applicable only when the video resolution is set to 720p, 1080i or 1080p).
  - **[4:3 Pillar Box]** - No stretching of picture. Black bars are displayed on both sides of the screen (applicable only when the video resolution is set to 720p, 1080i or 1080p).
  - **[Off]** - Picture is displayed according to the disc format.

- **[EasyLink Setup]** - If this product is connected to HDMI CEC compliant TV/devices, all connected devices can respond to the following commands simultaneously.
  - **[EasyLink]** - Turn on/off all EasyLink features.
  - **[One Touch Play]** - Turn on or off the feature of one-touch play.  
When EasyLink is enabled, press  $\odot$ .
    - ↳ This product turns on.
    - ↳ The TV (if the TV supports one-touch play) automatically turns on and switches to the video-in channel.
    - ↳ Disc play starts if there is a disc in this product.
  - **[One Touch Standby]** - Turn on or off the feature of one-touch standby.  
When EasyLink is enabled, press and hold  $\odot$  for at least three seconds.
    - ↳ All connected HDMI CEC compliant devices switch to standby mode.









#### Note

- You must turn on the HDMI CEC operations on the TV/ devices before you can enjoy the EasyLink controls. See the TV/devices manual for details.
- Philips does not guarantee 100% interoperability with all HDMI CEC compliant devices.

## Preferences

#### Note

- Stop disc play before you can access to **[Preferences]**.

Preferences	
	Audio
	Subtitle
	Disc Menu
	Parental Control
	PBC
	Mp3/Jpeg Nav
	Password
	DivX Subtitle

- 1 Press **SETUP**.  
↳ **[General Setup]** menu is displayed.
- 2 Press  $\blacktriangledown$  to select **[Preferences]**, and then press  $\blacktriangleright$  to enter the submenu.

- 3 Select an option, and then press **OK**.
- 4 Select a setting, and then press **OK**.
  - To return to the previous menu, press **↶ BACK**.
  - To exit the menu, press **SETUP**.

#### [Audio]

Select an audio language for disc play.

#### [Subtitle]

Select a subtitle language for disc play.

#### [Disc Menu]

Select a disc menu language.

#### Note

- If the language you have set is not available on the disc, the disc uses its own default language.
- For some DVDs, the subtitle/audio language can only change from the disc menu.
- To select the languages that are not listed in the menu, select **[Others]**. Then check the Language Code list at the back of this user manual and enter the respective language code.

#### [Parental Control]

Restrict access to discs that are unsuitable for children. These types of discs must be recorded with ratings.

1. Press **OK**.
2. Select a rating level, then press **OK**.
3. Press the **numeric buttons** to enter the password.

#### Note

- Rated DVDs above the level you set in **[Parental Control]** require a password to be played.
- The ratings are country-dependent. To allow all discs to play, select **'8'**.
- Some discs have ratings printed on them but are not recorded with ratings. This function has no effect on such discs.

#### [PBC]

Turn on or off the content menu of VCDs/SVCDs with PBC (playback control) feature.

- **[On]** - Display the index menu when you load a disc for play.
- **[Off]** - Skip the menu and start play from the first track.

#### [Mp3/Jpeg Nav]

Select to display the folders or display all the files.

- **[View Files]** - Display all the files.
- **[View Folders]** - Display the folders of MP3/WMA files.

#### [Password]

Set or change the password for locked discs and play restricted DVDs.



Preferences Change Password	
Old Password	<input type="text"/>
New Password	<input type="text"/>
Confirm PWD	<input type="text"/>
<input type="button" value="OK"/>	

1. Press the **Numeric buttons** to enter '136900' or the last set password at [**Old Password**] field.
2. Enter the new password at [**New Password**] field.
3. Enter the new password again at [**Confirm PWD**] field.
4. Press **OK** to exit the menu.

#### Note

- If you forget the password, enter '136900' before you set a new password.

#### [DivX Subtitle]

Select a character set that supports the DivX subtitle.

- **[Standard]** - English, Irish, Danish, Estonian, Finnish, French, German, Italian, Portuguese, Luxembourgish, Norwegian (Bokmål and Nynorsk), Spanish, Swedish, Turkish
- **[Hebrew]** - Hebrew
- **[中文 (简体)]** - Simplified Chinese

#### Note

- Ensure that the subtitle file has the exact same file name as the movie file. If for example the file name of the movie is 'Movie.avi', then you need to name the text file 'Movie.sub' or 'Movie.srt'.

#### [Version Info]

Display the software version of this product.

#### Note

- This information is required when you want to find out if a newest software version is available at the Philips website that you may download and install on this product.

#### [Default]

Reset all the settings of this product to factory default, except for [**Disc Lock**], [**Parental Control**] and [**Password**] settings.

## 8 Additional information

### Update software

For software updates, check the current software version of this product to compare with the latest software (if available) at the Philips website.



#### Caution

- Power supply must not be interrupted during software upgrade.

- 1 Press **SETUP**.
- 2 Select [**Preferences**] > [**Version Info**], and then press **OK**.
- 3 Write down the file name, and then press **SETUP** to exit the menu.
- 4 Visit [www.philips.com/support](http://www.philips.com/support) to check for the latest software version, using the file name for this product.
- 5 Refer to the upgrade instructions on the website for more information.



#### Note

- Disconnect the power cord for a few seconds and connect again to turn on the product.

### Care



#### Caution

- Never use solvents such as benzene, thinner, cleaners available commercially, or anti-static sprays intended for discs.

#### Clean discs

Wipe the disc with a micro fibre cleaning cloth from the centre to the edge in a straight line movement.

### Specifications



#### Note

- Specification and design are subject to change without notice

#### USB

- Compatibility: Hi-Speed USB (2.0)
- Class support: UMS (USB Mass Storage Class)

#### Video

- Signal system: PAL / NTSC

- Composite video output: 1 Vpp ~ 75 ohm
- Component video output: 0.7 Vpp ~ 75 ohm
- HDMI output: 480i, 480p, 576i, 576p, 720p, 1080i, 1080p

#### Audio

- Analog stereo output
- Signal to noise ratio (1 kHz): > 90 dB (A-weighted)
- Dynamic Range (1 kHz): > 80 dB (A-weighted)
- Crosstalk (1 kHz): > 90 dB
- Distortion/noise: (1 kHz): > 75 dB
- MPEG MP3: MPEG Audio L3
- Digital output
  - Coaxial
- HDMI output

#### Main unit

- Dimensions (w x h x d): 360 x 39 x 209 (mm)
- Net Weight: approximately 1.4 kg

#### Power

- Power supply rating: 110-240V, 50/60HZ
- Power consumption: < 10 W
- Power consumption in standby mode: < 0.45 W

#### Accessories supplied

- Remote control and batteries
- Audio/Video cables
- AC power cord
- User Manual
- Quick Start Guide

#### Laser specification

- Type: Semiconductor laser InGaAlP (DVD), AlGaAs (CD)
- Wave length: 655 nm (DVD), 790 nm (CD)
- Output Power: 7.0 mW (DVD), 10.0 mW (VCD/CD)
- Beam divergence: 60 degrees

## 9 Troubleshooting



### Warning

- Risk of electric shock. Never remove the casing of the product.

To keep the warranty valid, never try to repair the product yourself.

If you have problems using this product, check the following points before you request service. If you still have a problem, register your product and get support at [www.philips.com/welcome](http://www.philips.com/welcome).

If you contact Philips, you will be asked for the model and serial number of your product. The model number and serial number are on the back of your product. Write the numbers here:

Model No. \_\_\_\_\_

Serial No. \_\_\_\_\_

### Main unit

**The buttons on this unit do not work.**

- Disconnect this product from the power outlet for a few minutes, then connect again.

**No reaction to the remote control.**

- Connect this product to the power outlet.
- Point the remote control at the IR sensor located on the front panel of this product.
- Insert the batteries correctly.
- Insert new batteries in the remote control.

### Picture

**No picture.**

- See the TV's user manual on how to select the correct input on the TV. Change the TV channel until you see the Philips screen.
- If you have turned on the progressive scan setting or change the TV system setting, switch back to default mode: 1) Press **▲** to open the disc compartment. 2) Press the **Numeric button '1'** (for progressive scan) or the **Numeric button '3'** (for TV system).

**No picture on HDMI connection.**

- If this product is connected to an unauthorized display device with an HDMI cable, the audio/video signal may not be output.
- Check if the HDMI cable is faulty. Replace a new HDMI cable.
- If this happens when you change the HDMI video resolution, you have to switch to its default mode: 1) Press **▲** to open the disc compartment. 2) Press the **numeric button "1"**.

### Sound

**No audio output from the TV.**

- Ensure that the audio cables are connected to the audio input of the TV.
- Assign the audio input of the TV to the corresponding video input. See the TV user manual for details.

**No audio output from the loudspeakers of the audio device (stereo system/amplifier/receiver).**

- Ensure that the audio cables are connected to the audio input of the audio device.
- Turn on the audio device to its correct audio input source.

---

### No sound on HDMI connection.

- You may not hear any sound from the HDMI output if the connected device is non-HDCP compliant or only DVI-compatible.
- Ensure that the **[HDMI Audio]** setting is turned on.

### No sound during DivX video playback

- The audio codec may not be supported by this product.

---

## Play

### The disc cannot be played.

- The disc is badly scratched, deformed, or dirty. Replace or clean the disc.
- Use the correct disc format or file format.

### DivX video files cannot be played.

- Ensure that the DivX video file is complete.
- Ensure that the file name extension is correct.

### The aspect ratio of the screen is not aligned with the TV display setting.

- The aspect ratio is fixed on the disc.

### DivX subtitles are not displayed correctly.

- Ensure that the subtitle file name is the same as the movie file name.
- Select the correct character set.
  - Press **SETUP**.
  - Select **[Preferences] > [DivX Subtitle]** in the menu.
  - Select the character set that supports the subtitle.

---

# 10 Glossary

---

## A

### Aspect ratio

Aspect ratio refers to the length to height ratio of TV screens. The ratio of a standard TV is 4:3, while the ratio of a high-definition or wide TV is 16:9. The letter box allows you to enjoy a picture with a wider perspective on a standard 4:3 screen.

---

## D

### DivX Video-On-Demand

This DivX Certified<sup>®</sup> device must be registered in order to play DivX Video-on-Demand (VOD) content. To generate the registration code, locate the DivX VOD section in your device setup menu. Go to [vod.divx.com](http://vod.divx.com) with this code to complete the registration process and learn more about DivX video.

---

## H

### HDMI

High-Definition Multimedia Interface is a high-speed digital interface that can transmit uncompressed high definition video and digital multichannel audio. It delivers high quality picture and sound quality, completely free from noise. HDMI is fully backward-compatible with DVI.

As required by the HDMI standard, connecting to HDMI or DVI products without HDCP (High-bandwidth Digital Content Protection) will result in no Video or Audio output.

---

## J

### JPEG

A very common digital still picture format. A still-picture data compression system proposed by the Joint Photographic Expert Group, which features small decrease in image quality in spite of its high compression ratio. Files are recognized by their file extension '.jpg' or '.jpeg.'

---

## M

### MP3

A file format with a sound data compression system. MP3 is the abbreviation of Motion Picture Experts Group 1 (or MPEG-1) Audio Layer 3. With the MP3 format, one CD-R or CD-RW can contain about 10 times more data than a regular CD.

---

## P

### PBC

Playback Control. A system where you navigate through a Video CD/Super VCD with on-screen menus that are recorded onto the disc. You can enjoy interactive playback and search.

### Progressive scan

The progressive scan displays twice the number of frames per second than in an ordinary TV system. It offers higher picture resolution and quality.

---

## W

### WMA

Windows Media™ Audio. Refers to an audio compression technology developed by Microsoft Corporation. WMA data can be encoded with Windows Media player version 9 or Windows Media player for Windows XP. Files are recognized by their file extension '.wma.'

## Language Code

Abkhazian	6566
Afar	6565
Afrikaans	6570
Amharic	6577
Arabic	6582
Armenian	7289
Assamese	6583
Avestan	6569
Aymara	6589
Azerhijani	6590
Bahasa Melayu	7783
Bashkir	6665
Belarusian	6669
Bengali	6678
Bihari	6672
Bislama	6673
Bokmål, Norwegian	7866
Bosanski	6683
Brezhoneg	6682
Bulgarian	6671
Burmese	7789
Castellano, Español	6983
Catalán	6765
Chamorro	6772
Chechen	6769
Chewa; Chichewa; Nyanja	7889
中文	9072
Chuang; Zhuang	9065
Church Slavic; Slavonic	6785
Chuvash	6786
Corsican	6779
Česky	6783
Dansk	6865
Deutsch	6869
Dzongkha	6890
English	6978
Esperanto	6979
Estonian	6984
Euskara	6985
Ελληνικά	6976
Faroese	7079
Français	7082
Frysk	7089
Fijian	7074
Gaelic; Scottish Gaelic	7168
Gallegan	7176
Georgian	7565
Gikuyu; Kikuyu	7573
Guarani	7178
Gujarati	7185
Hausa	7265
Herero	7290
Hindi	7273
Hiri Motu	7279
Hrvatski	6779
Ido	7379
Interlingua (International)	7365
Interlingue	7365
Inuktitut	7385

Inupiaq	7375
Irish	7165
Íslenska	7383
Italiano	7384
Ivrit	7269
Japanese	7465
Javanese	7486
Kalaallisut	7576
Kannada	7578
Kashmiri	7583
Kazakh	7575
Kernewek	7587
Khmer	7577
Kinyarwanda	8287
Kirghiz	7589
Komi	7586
Korean	7579
Kuanyama; Kwanyama	7574
Kurdish	7585
Lao	7679
Latina	7665
Latvian	7686
Letzeburgesch;	7666
Limburgan; Limburger	7673
Lingala	7678
Lithuanian	7684
Luxembourgish;	7666
Macedonian	7775
Malagasy	7771
Magyar	7285
Malayalam	7776
Maltese	7784
Manx	7186
Maori	7773
Marathi	7782
Marshallese	7772
Moldavian	7779
Mongolian	7778
Nauru	7865
Navaho; Navajo	7886
Ndebele, North	7868
Ndebele, South	7882
Ndonga	7871
Nederlands	7876
Nepali	7869
Norsk	7879
Northern Sami	8369
North Ndebele	7868
Norwegian Nynorsk;	7878
Occitan; Provençal	7967
Old Bulgarian; Old Slavonic	6785
Oriya	7982
Oromo	7977
Ossetian; Ossetic	7983
Pali	8073
Panjabi	8065
Persian	7065
Polski	8076
Português	8084

Pushto	8083
Russian	8285
Quechua	8185
Raeto-Romance	8277
Romanian	8279
Rundi	8278
Samoan	8377
Sango	8371
Sanskrit	8365
Sardinian	8367
Serbian	8382
Shona	8378
Shqip	8381
Sindhi	8368
Sinhalese	8373
Slovensky	8373
Slovenian	8376
Somali	8379
Sotho; Southern	8384
South Ndebele	7882
Sundanese	8385
Suomi	7073
Swahili	8387
Swati	8383
Svenska	8386
Tagalog	8476
Tahitian	8489
Tajik	8471
Tamil	8465
Tatar	8484
Telugu	8469
Thai	8472
Tibetan	6679
Tigrinya	8473
Tonga (Tonga Islands)	8479
Tsonga	8483
Tswana	8478
Türkçe	8482
Türkmen	8475
Twi	8487
Uighur	8571
Ukrainian	8575
Urdu	8582
Uzbek	8590
Vietnamese	8673
Volapuk	8679
Walloon	8765
Welsh	6789
Wolof	8779
Xhosa	8872
Yiddish	8973
Yoruba	8979
Zulu	9085

