

Register your product and get support at

www.philips.com/welcome



CSP1000



CSP1200

EN User manual

PHILIPS

1. Important

Safety

- Read and understand all instructions before you use the apparatus. If damage is caused by failure to follow instructions, the warranty does not apply.
 - Use only the supplied mounting hardware for a safe and secure installation.
 - The subwoofer is heavy. Attach it firmly to a solid thick baffle-board.
 - Do not continuously use the speaker system beyond the peak power handling capacity.
 - Keep credit cards, watches, recorded tapes etc. with magnetic coding away from the speaker system to prevent damage caused by the magnets in the speakers.
 - Clean the apparatus with soft, damp cloth. Never use substances such as alcohol, chemicals or household cleaners on the apparatus.
-

Notice

Environmental information

All unnecessary packaging has been omitted. We have tried to make the packaging easy to separate into three materials: cardboard (box), polystyrene foam (buffer) and polyethylene (bags, protective foam sheet.) Your system consists of materials which can be recycled and reused if disassembled by a specialized company. Please observe the local regulations regarding the disposal of packaging materials, exhausted batteries and old equipment.

Any changes or modifications made to this device that are not expressly approved by Philips Consumer Lifestyle may void the user's authority to operate the equipment.

2009 © Koninklijke Philips Electronics N.V. All rights reserved.

Specifications are subject to change without notice. Trademarks are the property of Koninklijke Philips Electronics N.V. or their respective owners. Philips reserves the right to change products at any time without being obliged to adjust earlier supplies accordingly.

Your car power subwoofer

Congratulations on your purchase, and welcome to Philips! To fully benefit from the support that Philips offers, register your product at www.philips.com/welcome.

Introduction

With the subwoofer, you can enjoy high quality sound performance with powerful bass and beats.

What's in the box

Check and identify the contents of your package:

- ① Subwoofer
- ② Screw_4x50mm (x10)
- ③ Frame

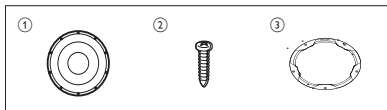

2. Installation

A depth of at least 124mm is required to mount the subwoofer. Measure the depth of the area where you are to mount the subwoofer, and ensure that the subwoofer does not obstruct any other components of the car.

Option 1: Mount on rear tray

You can mount the subwoofer on the rear tray.

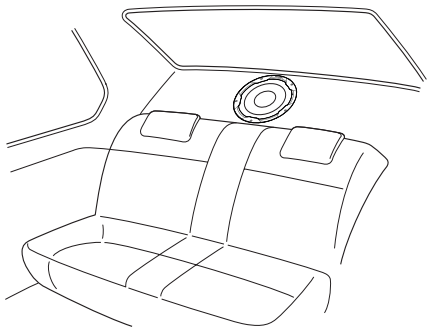

- 1 Turn off the car ignition key.
 - If the power is on, the click noise generated by the connection may damage the speakers.
- 2 Paste the supplied template onto the location for mounting the subwoofer.
- 3 Mark the cut-off hole and the 10 bolt holes.

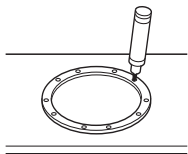

- 4 Cut out the marked area and drill the bolt holes.

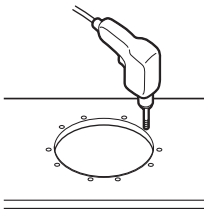

- 5 Connect the subwoofer to the amplifier.

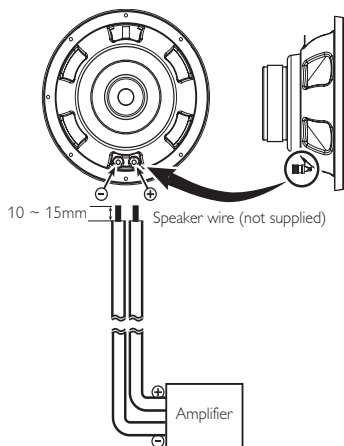

- 6 Mount the subwoofer into the rear tray with the supplied screws.

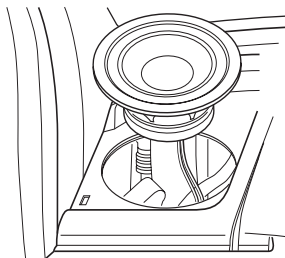

Option 2: Install in a sealed enclosure

If the subwoofer cannot be mounted on the car, place it in a sealed enclosure.

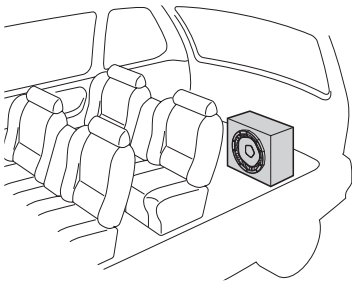

- 1 Make a sealed enclosure in dimension as below:

The box:

	CSP1000	CSP1200
Height	338mm	358mm
Length	522mm	568mm
Width	232mm	238mm

The mounting hole:

	CSP1000	CSP1200
Mounting hole diameter (Outside)	257.3mm	307mm
Mounting hole diameter (Inside)	231.9mm	283.7mm
Screw hole diameter	3.3mm	3.3mm

- 2 Connect the subwoofer to the amplifier (see step 5 of "Option 1: Mount on rear tray" section).

- 3 Install the subwoofer into the sealed enclosure with the supplied screws.

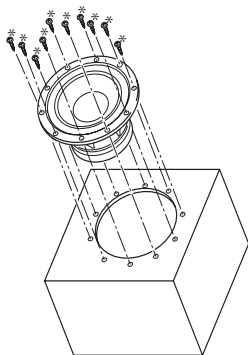

3. Product information



Note

- Product information is subject to change without prior notice.

Model	CSP1000	CSP1200
Speaker type	25cm subwoofer	30cm subwoofer
RMS power (Watts)	250W	400W
Peak music power (Watts)	1000W	1600W
Sensitivity (dB/W/m)	88dB	89dB
Frequency response (Hz)	25-1000Hz	20-1500Hz
Impedance (ohms)	4 ohms	4 ohms
Magnet mass (Oz)	55.4Oz	55.4Oz
Mounting depth (mm)	124mm	146mm

4. Troubleshooting

To keep the warranty valid, never try to repair the system yourself. If you encounter problems when using this apparatus, go to the Philips web site (www.philips.com/welcome). When you contact Philips, ensure that the apparatus is nearby and the model number and serial number are available.

Name of the Parts	Hazardous/toxic Substance					
	Pb, Lead	Hg, Mercury	Cd, cadmium	Chromium 6+	PBB	PBDE
Housing	○	○	○	○	○	○
Subwoofer	×	○	○	○	○	○
Loudspeakers	○	○	○	○	○	○
PWBs	×	○	○	○	○	○
Accessories (Remote control & cables)	×	○	○	○	○	○

- : Indicates that this toxic or hazardous substance contained in all of the homogeneous materials for this part is below the limit requirement in SJ/T11363 - 2006.
- ×
- X: Indicates that this toxic or hazardous substance contained in at least one of the homogeneous materials used for this part is above the limit requirement in SJ/T11363 - 2006.



Environmental Protection Use Period

This logo refers to the period (10 years) during which the toxic or hazardous substances or elements contained in electronic information products will not leak or mutate so that the use of these [substances or elements] will not result in any severe environmental pollution, any bodily injury or damage to any assets.

