

User Manual	6
使用説明書	56
Buku Pandan Pengguna	106

Thank you for choosing Philips.

Need help fast?

Read your Quick Use/Start Guide and/or User Manual first for quick tips that make using your Philips product more enjoyable.

*If you have read your instructions and still need assistance, you may access our online help at **www.philips.com/support***



PHILIPS

LASER

Type	Semiconductor laser GaAlAs
Wave length	650 - 660 nm (DVD) 784 - 796 nm (CD)
Output Power	7 mW (DVD) 10 mW (VCD/CD)
Beam divergence	60 degrees

CAUTION

Use of controls or adjustments or performance of procedures other than herein may result in hazardous radiation exposure or other unsafe operation.

Due to the inconsistency of disc formats provided by various disc manufacturers, your DVD system/ player/recorder may require a playability enhancement or upgrade. As DVD technology advances, these enhancement will become common and will be easy to complete. Go to www.philips.com/support for software upgrade.

'CONSUMERS SHOULD NOTE THAT NOT ALL HIGH DEFINITION TELEVISION SETS ARE FULLY COMPATIBLE WITH THIS PRODUCT AND MAY CAUSE ARTIFACTS TO BE DISPLAYED IN THE PICTURE. IN CASE OF 525 OR 625 PROGRESSIVE SCAN PICTURE PROBLEMS, IT IS RECOMMENDED THAT THE USER SWITCH THE CONNECTION TO THE 'STANDARD DEFINITION' OUTPUT. IF THERE ARE QUESTIONS REGARDING OUR TV SET COMPATIBILITY WITH THIS MODEL 525p AND 625p DVD PLAYER, PLEASE CONTACT OUR CUSTOMER SERVICE CENTER.'

ATTENTION!

For Customer Use:

Read carefully the information located at the bottom or rear of your DVD Home Theatre System and enter below the Serial No. Retain this information for future reference.

Model No. HTS6500

Serial No. _____



Manufactured under license from Dolby Laboratories, "Dolby", "Pro Logic" and the double-D symbol are trademarks of Dolby Laboratories.



Windows Media and the Windows logo are trademarks, or registered trademarks of Microsoft Corporation in the United States and/or other countries.



Manufactured under license from Digital Theater Systems, Inc. U.S. Pat. Nois. 5,451,942; 5,956,674; 5,974,380; 5,978,762; 6,226,616; 6,487,535 and other U.S. and world-wide patents issued and pending. "DTS" and "DTS Digital Surround" are registered trademarks of Digital Theater Systems, Inc. Copyright 1996, 2003 Digital Inc. All Rights Reserved.

HDMI

HDMI (High Definition Multimedia Interface) is a digital interface that allows pure HD digital video transmission without the loss of image quality. The integrated control bus allows system control between the TV set and connected devices like a digital set top box.



DivX Ultra Certified products: "DivX, DivX Ultra Certified, and associated logos are trademarks of DivX, Inc. and are used under license.

Language Code

Abkhazian	6566	Inupiaq	7375	Pushto	8083
Afar	6565	Irish	7165	Russian	8285
Afrikaans	6570	Íslenska	7383	Quechua	8185
Amharic	6577	Italiano	7384	Raeto-Romance	8277
Arabic	6582	Ivrit	7269	Romanian	8279
Armenian	7289	Japanese	7465	Rundi	8278
Assamese	6583	Javanese	7486	Samoan	8377
Avestan	6569	Kalaallisut	7576	Sango	8371
Aymara	6589	Kannada	7578	Sanskrit	8365
Azerhijani	6590	Kashmiri	7583	Sardinian	8367
Bahasa Melayu	7783	Kazakh	7575	Serbian	8382
Bashkir	6665	Kernewek	7587	Shona	8378
Belarusian	6669	Khmer	7577	Shqip	8381
Bengali	6678	Kinyarwanda	8287	Sindhi	8368
Bihari	6672	Kirghiz	7589	Sinhalese	8373
Bislama	6673	Komi	7586	Slovensky	8373
Bokmål, Norwegian	7866	Korean	7579	Slovenian	8376
Bosanski	6683	Kuanyama; Kwanyama	7574	Somali	8379
Brezhoneg	6682	Kurdish	7585	Sotho; Southern	8384
Bulgarian	6671	Lao	7679	South Ndebele	7882
Burmese	7789	Latina	7665	Sundanese	8385
Castellano, Español	6983	Latvian	7686	Suomi	7073
Catalán	6765	Letzeburgesch;	7666	Swahili	8387
Chamorro	6772	Limburgan; Limburger	7673	Swati	8383
Chechen	6769	Lingala	7678	Svenska	8386
Chewa; Chichewa; Nyanja	7889	Lithuanian	7684	Tagalog	8476
中文	9072	Luxembourgish;	7666	Tahitian	8489
Chuang; Zhuang	9065	Macedonian	7775	Tajik	8471
Church Slavic; Slavonic	6785	Malagasy	7771	Tamil	8465
Chuvash	6786	Magyar	7285	Tatar	8484
Corsican	6779	Malayalam	7776	Telugu	8469
Česky	6783	Maltese	7784	Thai	8472
Dansk	6865	Manx	7186	Tibetan	6679
Deutsch	6869	Maori	7773	Tigrinya	8473
Dzongkha	6890	Marathi	7782	Tonga (Tonga Islands)	8479
English	6978	Marshallese	7772	Tsonga	8483
Esperanto	6979	Moldavian	7779	Tswana	8478
Estonian	6984	Mongolian	7778	Türkçe	8482
Euskara	6985	Nauru	7865	Turkmen	8475
Ελληνικά	6976	Navaho; Navajo	7886	Twi	8487
Faroese	7079	Ndebele, North	7868	Uighur	8571
Français	7082	Ndebele, South	7882	Ukrainian	8575
Frysk	7089	Ndonga	7871	Urdu	8582
Fijian	7074	Nederlands	7876	Uzbek	8590
Gaelic; Scottish Gaelic	7168	Nepali	7869	Vietnamese	8673
Galleghan	7176	Norsk	7879	Volapuk	8679
Georgian	7565	Northern Sami	8369	Walloon	8765
Gikuyu; Kikuyu	7573	North Ndebele	7868	Welsh	6789
Guarani	7178	Norwegian Nynorsk;	7878	Wolof	8779
Gujarati	7185	Occitan; Provençal	7967	Xhosa	8872
Hausa	7265	Old Bulgarian; Old Slavonic	6785	Yiddish	8973
Herero	7290	Oriya	7982	Yoruba	8979
Hindi	7273	Oromo	7977	Zulu	9085
Hiri Motu	7279	Ossetian; Ossetic	7983		
Hrvatski	6779	Pali	8073		
Ido	7379	Panjabi	8065		
Interlingua (International)	7365	Persian	7065		
Interlingue	7365	Polski	8076		
Inuktitut	7385	Português	8084		

Index

English ----- 6

中文(繁體) ----- 56

Bahasa Melayu----- 106

English

中文(繁體)

Bahasa Melayu

Table of contents

General

General Information	8
Setup precautions.....	8
Accessories supplied	8
Cleaning discs	8
About recycling.....	8

Product Overview

Main Unit	9
Remote Control.....	10-12
Using the remote control	12

Connections

Basic Connections	13-17
Step 1 : Placing the speakers	13
Step 2 : Connecting the SonoWave speakers and subwoofer	14
Step 3 : Connecting to TV	15
Option 1: Using the Video (CVBS) jack (good picture quality).....	15
Option 2: Using the S-Video jack (excellent picture quality).....	15
Option 3: Connecting to a Progressive Scan TV or component video input.....	16
Option 4: Connecting to a HDMI-compatible TV	16
Step 4 : Connecting the FM/MW antennas.....	17
Step 5 : Connecting the power cord	17
Optional Connections	18-19
Connecting audio from TV	18
Connecting audio from an audio/video device.....	18
Mounting the speakers on the wall	19

Basic Setup

Getting Started	20-25
Step 1: Turning on the DVD system	20
Turning off to Eco Power standby mode.....	20
Step 2: Finding the correct viewing channel.....	20
Step 3: Setting language preferences.....	21
On-screen display (OSD) language.....	21
Audio, Subtitle and Menu language for DVD playback.....	21-22
Step 4: Setting the TV.....	22
Selecting the matching colour system	22-23
Setting the TV Display	23
Step 5: Setting up Progressive Scan feature.....	24
Step 6: Setting the SonoWave speakers	25

Disc Playback

Disc Operations	26-33
Playable discs	26
Playing a disc	26
Basic playback controls.....	27
Selecting various repeat/shuffle functions	27
Programming disc tracks.....	28
Other playback features for video discs (DVD/VCD/SVCD)	28
Using the Disc Menu	28
Viewing playback information.....	29

Table of contents

Resuming playback from the last stopped point	29
Zooming in	29
Changing subtitle language (DVD only)	29
Changing sound track language	30
Playback Control (VCD only)	30
Preview function (VCD/SVCD only)	30
Playing an MP3/ JPEG/Window Media Audio disc	31
Playing a JPEG image file (slide show)	32
Preview function	32
Zoom picture	32
Rotating/flipping the picture	32
Playing MP3 music and JPEG pictures simultaneously	33
Playing a DivX disc	33
Playing a Karaoke disc	34
Microphone setting	34

USB / MP3 Direct

USB Operations	35
Playing from USB flash drive or USB memory card reader	35
MP3 Direct Operations	36
Playing from a portable audio or HDD player	36

Setup Options

DVD Setup Menu Options	37-43
Accessing the DVD setup menu	37
General Setup Page	38
Audio Setup Page	39
Video Setup Page	40-41
Preference Setup Page	42-43

Radio Tuning

Tuner Operations	44-45
Tuning to radio stations	44
Presetting radio stations	44
Using auto install	44
Using automatic preset	45
Using manual preset	45
Selecting a preset radio station	45
Deleting a preset radio station	45
Changing tuning grid	45

Others

Sound and Volume Controls	46
Selecting surround sound	46
Selecting digital sound effects	46
Volume control	46
Other Features	47
Software upgrades	47
Troubleshooting	48-50
Specifications	51
Glossary	52-53
Frequently Asked Questions (USB)	54

General Information

CAUTION!

The machine does not contain any user-serviceable parts. Please leave all maintenance work to qualified personnel.

Setup precautions

Finding a suitable location

- Place the set on a flat, hard and stable surface. Do not place the set on a carpet.
- Do not position the set on top of other equipment that might heat it up (e.g., receiver or amplifier).
- Do not put anything under the set (e.g., CDs, magazines).
- Install this unit near the AC outlet where the AC power plug can be easily reached.

Space for ventilation

- Place the apparatus in a location with adequate ventilation to prevent internal heat build up. Allow at least 10 cm (4") clearance from the rear and the top of the set and 5cm (2") from the left and right to prevent overheating.

Avoid high temperatures, moisture, water and dust

- Apparatus must not be exposed to dripping or splashing.
- Do not place any sources of danger on the apparatus (e.g., liquid filled objects, lighted candles).

Accessories supplied

- 1 subwoofer
- 2 SonoWave speakers
- 2 sets of wall mounting brackets
- 1 remote control with batteries
- 1 composite video cable (yellow)
- 1 FM wire antenna
- 1 MW loop antenna
- 1 MP3 direct white cable (for connecting portable audio player)
- Quick Start Guide

Cleaning discs

To clean a disc, use a micro fiber cleaning cloth and wipe the disc from the center to the edge in a straight line.

CAUTION!

Do not use solvents such as benzene, thinner, commercially available cleaners, or anti-static sprays intended for discs.

About recycling

These operating instructions have been printed on non-polluting paper. The electronic equipment contains a large number of materials that can be recycled. If you are disposing of an old machine, please take it to a recycling center. Please observe the local regulations regarding disposal of packaging materials, exhausted batteries and old equipment.

Main Unit

English

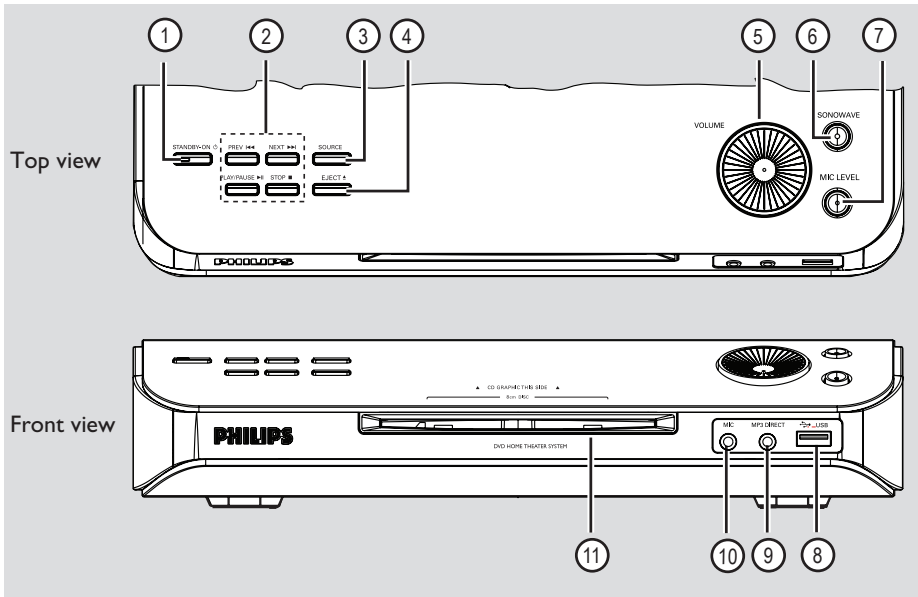

① **STANDBY ON**

- Turns on the system or turns off to Eco Power standby mode.

② **PLAY PAUSE**

- DISC: starts/pauses playback.
- TUNER: starts auto tuner installation for first time setup.

STOP

- Exits an operation.
- DISC: stops playback.
- TUNER: press and hold this button to erase the current preset radio station.

PREV **/** **NEXT**

- DISC: selects a track or press and hold this button to search backward/forward.
- TUNER: selects a preset radio station.

③ **SOURCE**

- Selects the relevant active source mode: DISC, MP3 DIRECT, TUNER (FM/MW), TV or AUX/DI.

④ **EJECT**

- Ejects the disc from the disc slot.

⑤ **VOLUME**

- Adjusts the volume level.

⑥ **SonoWave**

- Turns on the SonoWave speakers to multi-channel mode or turns off to stereo mode. While in multi-channel mode, the light will be on.

⑦ **MIC LEVEL**

- Activates microphone level mode and use the VOLUME control to set the microphone volume level.

⑧ **USB port**

- Input for USB flash drive or USB memory card reader.

⑨ **MP3 Direct**

- Phono input for connecting to the headphone out jack on your portable audio or HDD player.

⑩ **MIC**

- For connecting the microphone socket.

⑪ **Disc slot**

Remote Control

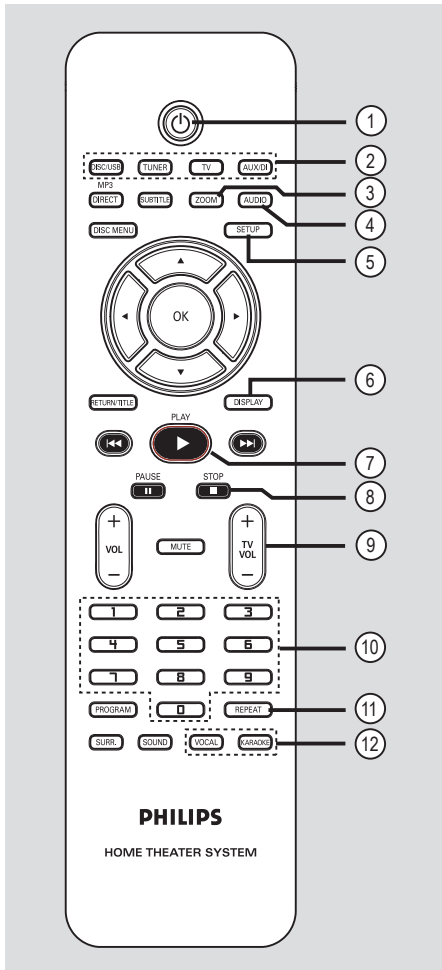

① **Power**
– Turns off to Eco Power standby mode.

② **Source buttons**
– **DISC/USB:** switches to DISC or USB mode.
TUNER: toggles between FM and MW band.
TV: switches to TV mode. The sound from the TV will output through the connected speakers system.
AUX/DI: toggles between AUX and DIGITAL IN external source mode.

③ **ZOOM**
– Enlarges a picture on the TV.

④ **AUDIO**
– Selects an audio language (DVD) or an audio channel (CD).

⑤ **SETUP**
– Enters or exits the system setup menu.

⑥ **DISPLAY**
– Displays the current status or disc information.

⑦ **PLAY ▶**
– DISC: starts playback.

⑧ **STOP ■**
– Exits an operation.
– DISC: stops playback.
– DISC: press and hold this button to eject the disc.
– TUNER: press and hold this button to erase the current preset radio station.

⑨ **TV VOL + –**
– Adjusts TV volume (Philips TV only).

⑩ **Numeric keypad (0-9)**
– Enters a track/title number of the disc.
– Enters a number of a preset radio station.

⑪ **REPEAT**
– Selects various repeat modes; turns off repeat mode.

⑫ **VOCAL**
– Toggles between various audio mode options.

KARAOKE

– Enters microphone setup menu.

Remote Control (continued)

13 MP3-DIRECT

- Switches to MP3 mode for the source connected through the MP3 Direct socket at the front panel.

14 SUBTITLE

- Selects a DVD subtitle language.

15 DISC MENU

- For DVD, enter or exit disc contents menu.
- For VCD/SVCD, enter digest menu.

16 ◀▶▲▼

- DISC: selects movement direction in the menu.
- TUNER: press up or down to tune the radio frequency up/down.
- TUNER: press left or right to start auto search.

17 OK

- Confirms a selection.

18 RETURN/TITLE

- For DVD, go back to the previous menu.
- For VCD version 2.0 only; During playback, display the disc title menu or return to the main menu.

19 ◀◀ ▶▶

- DISC: press and hold this button for fast forward and backward search.
- TUNER: selects a preset radio station.

20 PAUSE II

- DISC: pauses playback.

21 VOL + –

- Adjusts the volume level.

22 MUTE

- Mutes or restores the volume.

23 PROGRAM

- DISC: starts programming.
- TUNER: press and hold this button to start automatic/ manual preset programming.

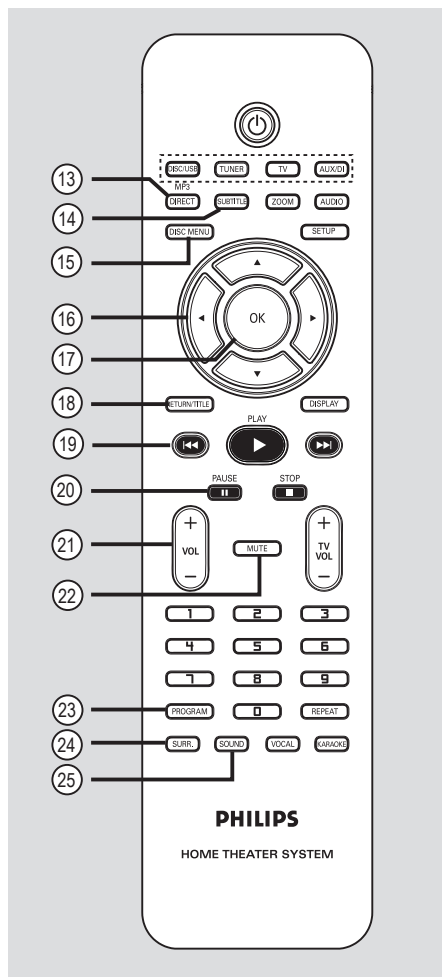

24 SURR.

- Selects multi-channel surround or stereo mode.

25 SOUND

- Selects a predefined sound effect.
- Press and hold this button to enter SonoWave speaker settings mode.

Remote Control (continued)

Using the remote control

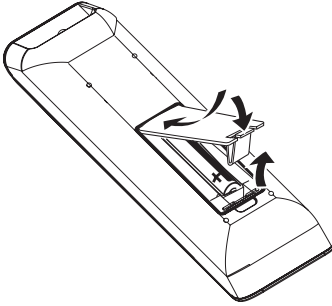

- 1 Open the battery compartment.
- 2 Insert two batteries type R03 or AAA, following the indications (+ -) inside the compartment.
- 3 Close the cover.
- 4 Point the remote control directly at the remote sensor (iR) on the front panel.

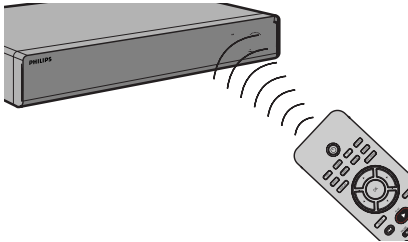

- 5 Select the source you wish to control by pressing the DISC, TUNER, TV, AUX/DI or MP3 DIRECT button on the remote control.
- 6 Then select the desired function (for example ◀◀, ▶▶).

CAUTION!

- Remove batteries if they are exhausted or if the remote control is not to be used for a long time.
- Do not mix batteries (old and new or carbon and alkaline, etc.).
- Batteries contain chemical substances, so they should be disposed of properly.

Basic Connections

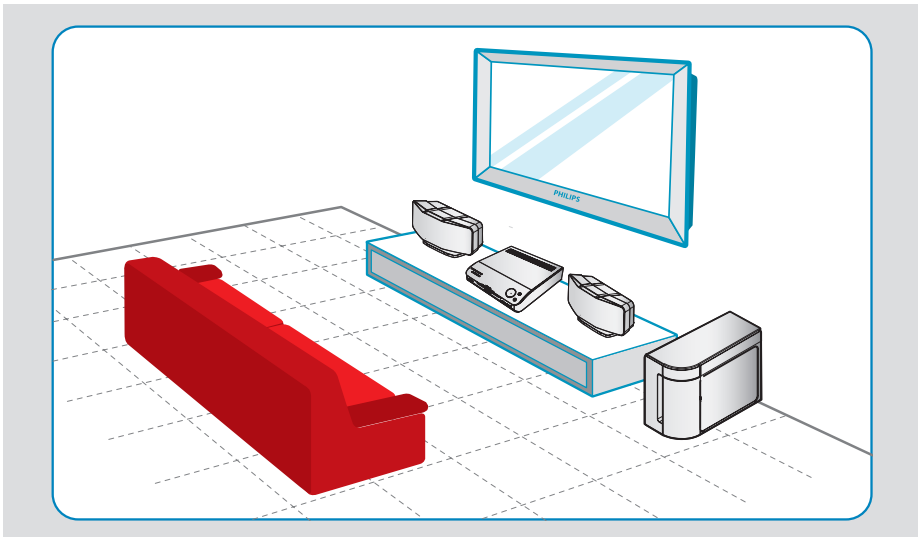

Step 1: Placing the speakers

The Philips Home Theater System is simple to install. However, proper system placement is critical to ensure an optimum sound experience.

Before you start ...

If you wish to mount the SonoWave speakers on the wall, see section 'Optional Connections - Mounting the SonoWave speakers on the wall.'

- 1 Place the SonoWave speakers at the normal listening ear level, equal distance from the TV and face straight ahead towards the listening area.



- 2 Place the subwoofer at the corner of the room. Keep at least one meter away from the TV.

Helpful Hints:

- The placement diagram shown here is only a guideline that will provide great system performance. You may find other placement choices that are more suitable for your room layout and provide the sound experience you enjoy.
- To avoid magnetic interference, do not position the front speakers too close to your TV.
- Do not place the SonoWave speakers at an angle as it would reduce the system performance.
- For SonoWave speakers setting, see 'Getting Started - Step 6: Setting the SonoWave speakers.'

Basic Connections (continued)

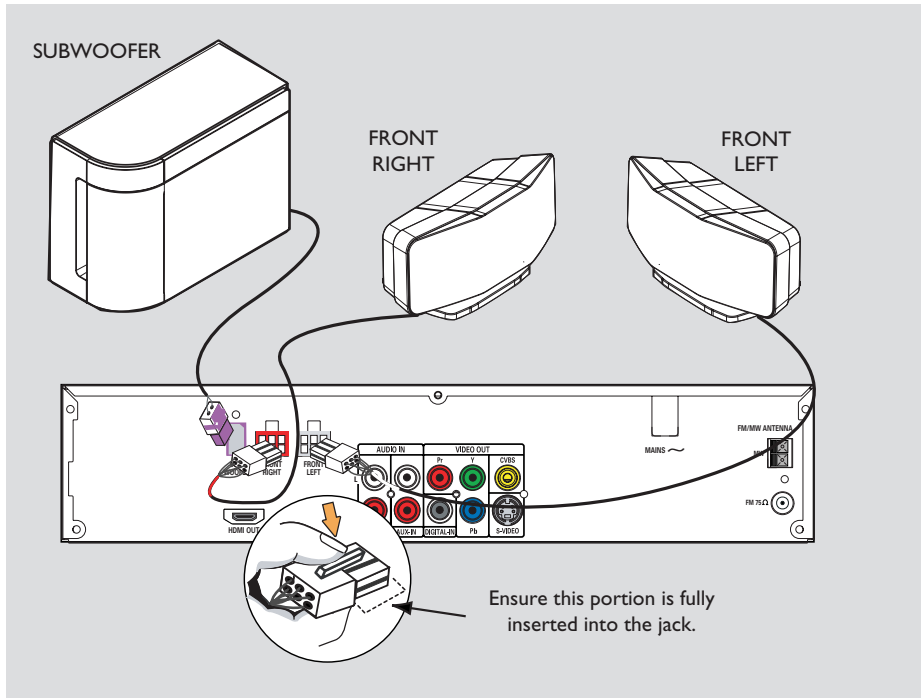

Step 2: Connecting the SonoWave speakers and subwoofer

- Connect the SonoWave speakers to the matching speaker jacks at the rear of the DVD system.

Helpful Hints:

- To prevent unwanted noise, do not place the SonoWave speakers too close to the DVD system, AC power adapter, TV or any other radiation sources.
- To disconnect the SonoWave speakers, press down the catch before pulling out the cable.

TIPS: Before making or changing any connections, make sure that all the devices are disconnected from the power outlet.

Basic Connections (continued)

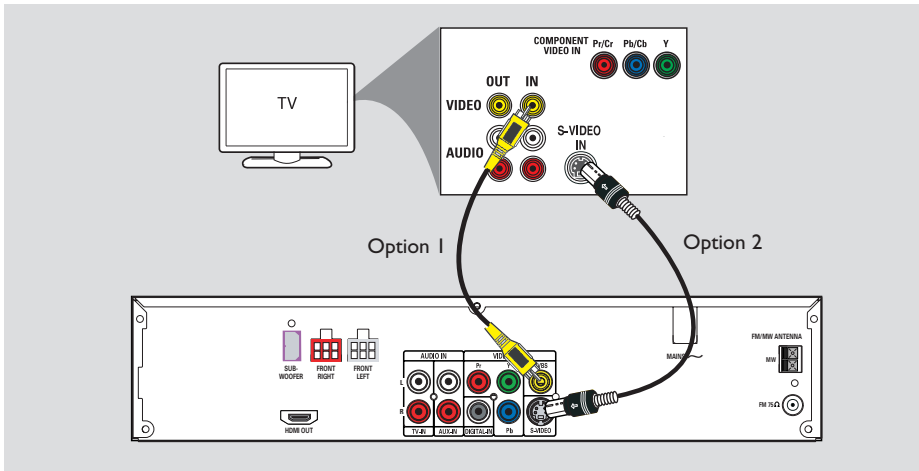

Step 3: Connecting to TV

This connection enables you to view the playback from this DVD system. You only need to choose **one** of the options below to make the video connection.

- For a standard TV, follow option 1 or 2.
- For a progressive scan TV, follow option 3.
- For a HDMI TV, follow option 4.

IMPORTANT!

Connect the DVD system directly to the TV.

Helpful Hint:

– To hear the TV channels through this DVD system, connect the **AUDIO IN - TV IN** jacks to the corresponding **AUDIO** output jacks on the TV using an audio cable. Press **TV** on the remote control when watching the TV programs.

Option 1: Using the Video (CVBS) jack (good picture quality)

- Use the supplied composite video cable (yellow) to connect the **CVBS** jack on the DVD system to the video input jack (or labeled as **A/V In**, **Video In**, **Composite** or **Baseband**) on the TV.

Option 2: Using the S-Video jack (excellent picture quality)

- Use an S-video cable (not supplied) to connect the **S-VIDEO (Y/C)** jack on the DVD system to the S-Video input jack (or labeled as **Y/C** or **S-VHS**) on the TV.

TIPS: Before making or changing any connections, make sure that all the devices are disconnected from the power outlet.

Basic Connections (continued)

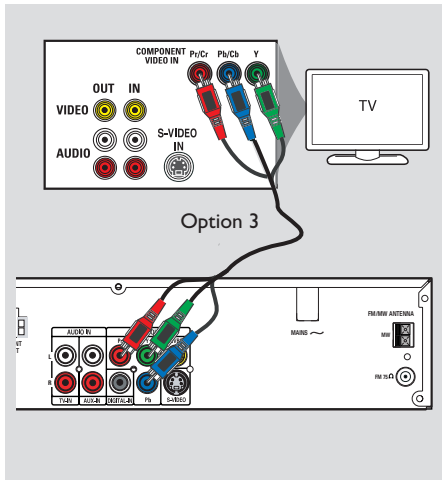

Option 3: Connecting to a Progressive Scan TV or component video input

The progressive scan video quality is only available when using Y Pb Pr connection and a progressive scan TV is required. It provides superior picture quality when watching DVD movies.

- 1 Follow option 1 to make the basic video connection.
- 2 Use the component video cables (red/blue/green - not supplied) to connect the **Y Pb Pr** jacks on the DVD system to the corresponding component video input jacks (or labeled as Y Pb/Cb Pr/Cr or YUV) on the TV.
- 3 If your TV accepts progressive signals, proceed to 'Getting Started - Step 5: Setting up Progressive Scan feature' for detailed progressive feature setup.

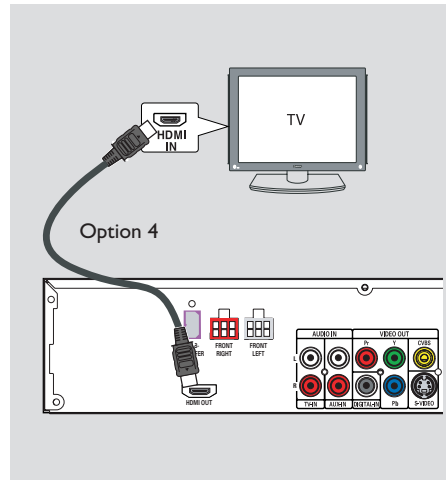

Option 4: Connecting to a HDMI-compatible TV

HDMI (High Definition Multimedia Interface) is a digital interface that allows pure digital video transmission without the loss of image quality.

- 1 Use an HDMI cable (not supplied) to connect the **HDMI OUT** on this DVD system to the **HDMI IN** on a HDMI-compatible device (e.g. HDMI TV, HDCP compliant DVI TV).
- 2 When you have completed the necessary connections, installation and set-up, see 'Audio Setup Page and Video Setup Page' for optimum HDMI audio and video settings.

Helpful Hints:

- The HDMI is backward compatible with some DVI devices using an appropriate adaptor plug.
- If a DVI device is connected, an additional audio cable is required for audio transmission.
- Most of the older DVI enable devices are not HDCP compliant and playback is not possible.

TIPS: Before making or changing any connections, make sure that all the devices are disconnected from the power outlet.

Basic Connections (continued)

English

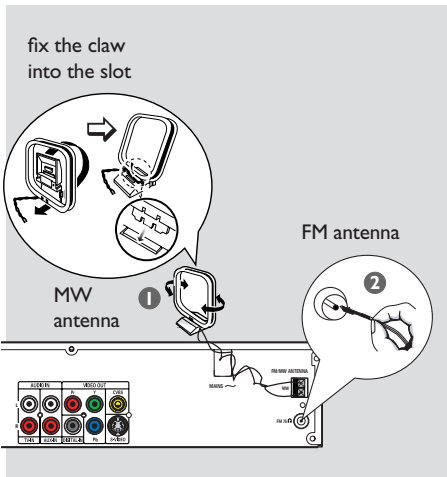

Step 4: Connecting the FM/MW antennas

- 1 Connect the supplied MW loop antenna to the **MW** jack. Place the MW loop antenna on a shelf, or attach it to a stand or wall.
- 2 Connect the supplied FM antenna to the **FM** jack. Extend the FM antenna and fix its ends to the wall.

For better FM stereo reception, connect an external FM antenna (not supplied).

Helpful Hints:

- Adjust the position of the antennas for optimal reception.
- Position the antennas as far away as possible from your TV, VCR or other radiation source to prevent any unwanted interference.

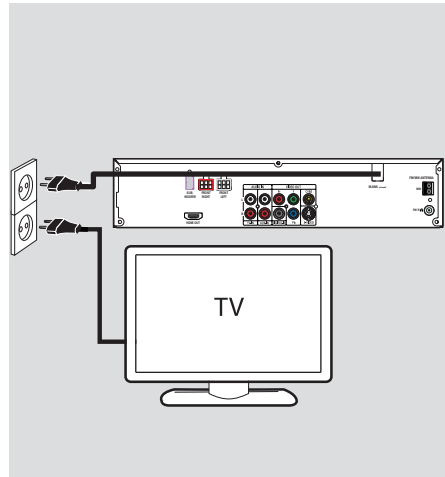

Step 5: Connecting the power cord

After everything is connected properly, plug the AC power cord into the power outlet.

The Eco Power LED on the DVD system will light up. Never make or change any connections with the power turned on.

Helpful Hint:

- Refer to the type plate at the rear or bottom of the product for identification and supply ratings.

TIPS: Before making or changing any connections, make sure that all the devices are disconnected from the power outlet.

Optional Connections

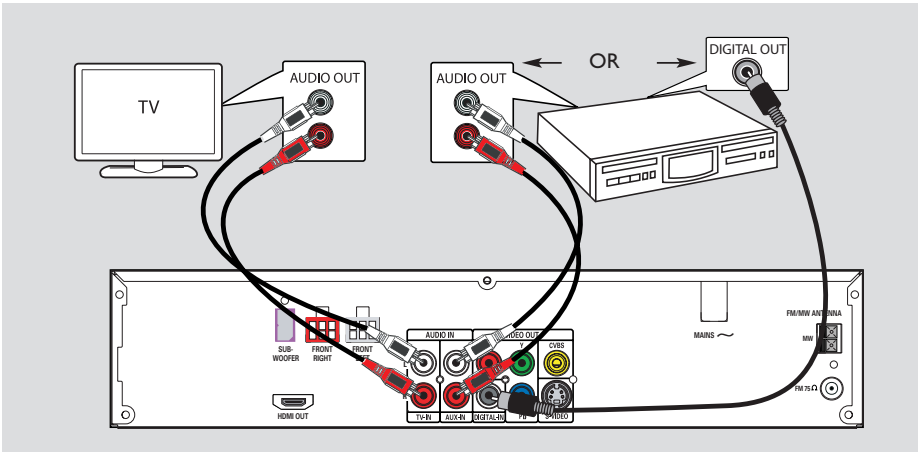

Connecting audio from TV

When connecting the audio output from your TV to this Home Theater Audio System, you will have the sound of the TV output on all the speakers. It will enable you to enjoy the multi-channel surround sound capabilities.

- Use an audio cable (red/white - not supplied) to connect the **TV IN** jacks on this DVD system to the **AUDIO OUT** jacks on the TV.

To listen to the sound, press **TV** on the remote control as the sound source that you want to play.

Connecting audio from an audio/video device

This DVD system provides analog and digital audio connection. You can connect the audio output from an audio/video device (e.g. VCR, Cable/Satellite Box) to this Home Theater Audio System in order to enjoy the multi-channel surround sound capabilities.

- Use an audio cable (red/white - not supplied) to connect the **AUX IN** jacks on this DVD system to the **AUDIO OUT** jacks on the connected device.

To listen to the sound, press **AUX/DI** to select "AUX" as the sound source that you want to play.

Or

- Use a coaxial cable (not supplied) to connect the **DIGITAL IN** jack on this DVD system to the **DIGITAL OUT** jack on the connected device.

To listen to the sound, press **AUX/DI** to select "DI" as the sound source that you want to play.

TIPS: Refer to the respective connected device's user manual for other possible connections.

Optional Connections (continued)

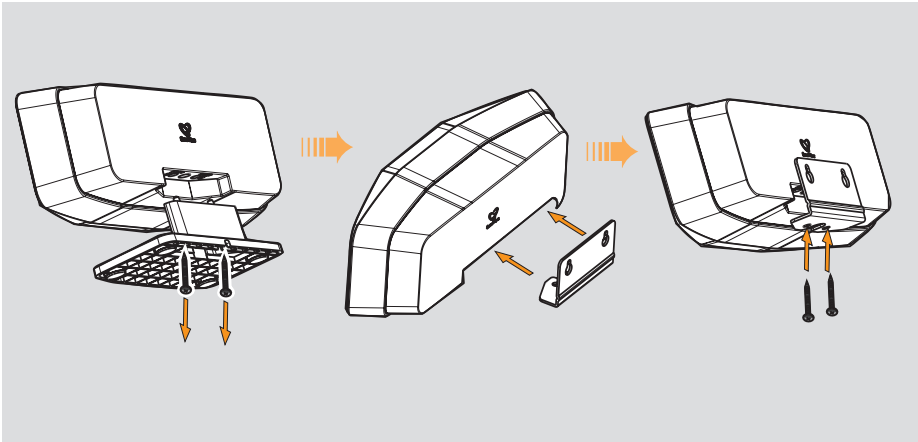

Mounting the speakers on the wall

You can choose to wall mount the speakers on the wall.

CAUTION!

You should get a qualified person to drill and insert the mounting screws (not supplied) on the wall. DO NOT do it yourself in order to avoid any unexpected damage to the equipment or injury to personnel.

Helpful Hint:

– Philips accepts absolutely no liability for any accidents or damage resulting from inadequate assembly or mounting, misuse or abuse, or natural disasters.

- 1 Loosen the screws at the bottom of the speakers and remove the base covers. See the above illustrations.
- 2 Attach the supplied brackets to the rear of the speakers and use the screws to secure the connections at the bottom of the speakers.
- 3 Drill holes on the wall where the speakers are to be hung. Mount the rubber wall plugs and screws (not supplied) to the wall.
- 4 Hook the speakers firmly onto the screws, by ensuring that they fit into the brackets at the rear of the speakers.

TIPS: Refer to the respective connected device's user manual for other possible connections.

Getting Started

Step 1: Turning on the DVD system

- Press the **SOURCE** button on the front panel repeatedly to select :
DISC → MP3 DIRECT → FM → MW →
TV → AUX → DI → DISC

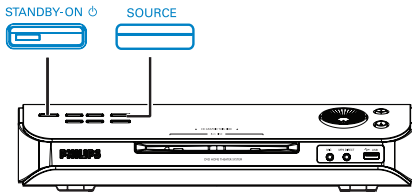

Or

- Press **DISC/USB, TUNER, TV, AUX/DI** or **MP3 DIRECT** on the remote control.
 - If the USB is detected, pressing the **DISC/USB** will toggle between DISC and USB mode.
 - Press **TUNER** to toggle between FM and MW band.
 - Press **AUX/DI** to toggle between analog audio input and digital audio input.
 - Press **MP3 DIRECT** to playback the audio tracks from your portable audio/HDD player which is connected to this DVD system.

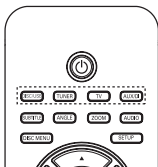

Turning off to Eco Power standby mode

- Press **STANDBY ON** (⏻).
 - The display screen will turn off.

Step 2: Finding the correct viewing channel

Before you start ...

Make sure you have completed all the necessary connections before proceeding.

- 1 Press **SOURCE** button until "DISC" appears on the display panel.
- 2 Turn on the TV and set it to the correct video-in channel. You should see the blue DVD background screen on the TV.
 - You may go to Channel 1 on your TV, then press the Channel Down button on your TV's remote control until you see the Video In channel.
 - You may press **⏻** button repeatedly on your TV's remote control.
 - Usually this channel is between the lowest and highest channels and may be called FRONT, A/V IN, VIDEO. See your TV manual for more details.

Getting Started (continued)

Step 3: Setting language preferences

The language options are different depending on your country or region. It may not correspond to the illustrations shown on the user manual.

On-screen display (OSD) language

The OSD (On-Screen Display) language for this DVD system will remain as you have set it, regardless of the changes made to the DVD disc language.

- 1 In 'DISC' mode, press **SETUP** on the remote control.
→ { **General Setup Page** } appears.
- 2 Use ▲▼ keys to highlight { **OSD Language** }, then press ►.

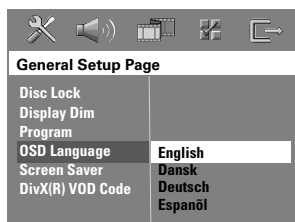

- 3 Use ▲▼ keys to select a language and press **OK** to confirm.

Audio, Subtitle and Menu language for DVD playback

You can select your preferred language settings for DVD playback. If the selected language is recorded on the DVD disc, the DVD system will automatically play the disc in that language. Otherwise, the disc's default language will be used instead.

- 1 Press ■ twice to stop playback (if any), then press **SETUP**.
- 2 Press ► repeatedly to select { **Preference Page** }.
- 3 Use ▲▼ keys to highlight one of the options below, then press ►.

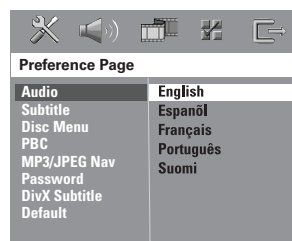

{ **Audio** }

Selects the preferred audio language for DVD playback.

{ **Subtitle** }

Selects the preferred subtitle language for DVD playback.

{ **Disc Menu** }

Selects the preferred disc menu language for DVD playback.

- 4 Use ▲▼ keys to select a language and press **OK** to confirm.

TIPS: Press ◀ to go back to the previous menu item. Press **SETUP** to exit the menu.

Getting Started (continued)

If the language you want is not available in the list, select { **Others.** }

Use the **numeric keypad (0-9)** on the remote control to enter the 4-digit language code 'XXXX' (see page 4) and press **OK** to confirm.

- 5 Repeat steps 3 ~ 4 for other settings.

Helpful Hints:

– During DVD playback, you can switch the audio and subtitle languages by pressing the **AUDIO** and **SUBTITLE** buttons on the remote control. However, this does not change the default settings you have made here.

– For some DVDs, the subtitle/audio/menu language can only be changed via the DVD disc menu.

Step 4: Setting the TV

Selecting the matching color system

The color system of the DVD system, DVD and TV should match. Only then will it be possible to play a DVD on this system. Before changing the TV system, determine the color system of your TV.

- 1 In 'DISC' mode, press **SETUP** on the remote control.
- 2 Press **▶** repeatedly to select { **Video Setup Page** }.
- 3 Press **▼** to highlight { **TV Type** }, then press **▶**.

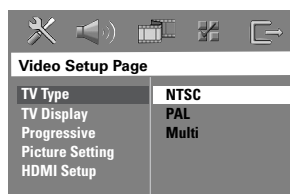

{ **PAL** }

Select this if the connected TV has the PAL color system. It will change the video signal of an NTSC disc and output it to PAL format.

{ **NTSC** }

Select this if the connected TV has the NTSC color system. It will change the video signal of a PAL disc and output it to NTSC format.

{ **Multi** }

Select this if the connected TV is compatible with both NTSC and PAL (multi-system). The output format will be in accordance with the video signal of the disc.

TIPS: The underlined option is the factory default setting.
Press **◀** to go back to the previous menu item. Press **SETUP** to exit the menu.

Getting Started (continued)

- 4 Select one of the options and press **OK** to confirm.
→ Follow the instructions shown on the TV to confirm the selection (if any).
→ If a blank/distorted TV screen appears, wait for 15 seconds for the auto recovery.

Setting the TV Display

Set the aspect ratio of the DVD system according to the TV type you have connected. The format you select must be available on the disc. If it is not, the setting for TV display will not affect the picture during playback.

- 1 In 'DISC' mode, press **SETUP** on the remote control.
- 2 Press **▶** repeatedly to select { **Video Setup Page** }.
- 3 Press **▼** to highlight { **TV Display** }, then press **▶**.

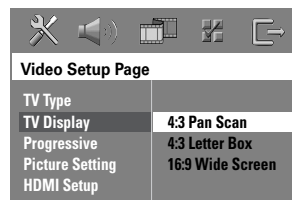

{ **4:3 Pan Scan** }

Select this if you have a conventional TV and want both sides of the picture to be trimmed or formatted to fit your TV.

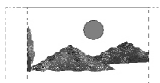

{ **4:3 Letter Box** }

Select this if you have a conventional TV. In this case, a wide picture with black bands on the upper and lower portions of the TV will be displayed.



{ **16:9 Wide Screen** }

Select this if you have a wide-screen TV.

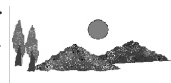

- 4 Select one of the options and press **OK** to confirm.

TIPS: The underlined option is the factory default setting.
Press **◀** to go back to the previous menu item. Press **SETUP** to exit the menu.

Getting Started (continued)

Step 5: Setting up Progressive Scan feature

(for Progressive Scan TV only)

The progressive scan displays twice the number of frames per second than interlaced scanning (ordinary normal TV system). With nearly double the number of lines, progressive scan offers higher picture resolution and quality.

Before you start...

Ensure that you have connected this DVD system to a progressive scan TV using the Y Pb Pr connection (see 'Option 3: Connecting to a Progressive Scan TV or component video input').

- 1 Turn off your TV progressive scan mode or turn on to the interlaced mode (refer to your TV's user manual).
- 2 Turn on the DVD system and press **SOURCE** button until "DISC" appears on the display panel.
- 3 Turn on the TV and set it to the correct video-in channel.
→ The blue DVD background screen will appear on the TV.
- 4 Press **SETUP** on the remote control.
- 5 Press **▶** repeatedly to select { **Video Setup Page** }.
- 6 Select { **Progressive** } > { **On,** } then press **OK** to confirm.

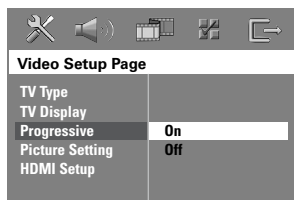

- 7 Read the notification message on the TV and confirm your action by selecting the **OK** in the menu and press **OK**.
→ If a blank/distorted screen appears, wait for 15 seconds for the auto recovery.
- 8 Otherwise, select { **Cancel** } and press **OK** to go back to the previous menu.

There will be no picture on your TV at this state until you have turned on the progressive scan mode on your TV.

- 8 Turn on your TV progressive scan mode (refer to your TV's user manual).
→ A message appears on the TV.
- 9 Confirm your action by selecting the **OK** in the menu and press **OK**.
→ The setup is now completed and you can start to enjoy the high quality picture.

If no picture is displayed:

- 1 Press **EJECT** **▲**.
- 2 Press **◀** on the remote control.
- 3 Press **MUTE** on the remote control.

Helpful Hint:

– There are some progressive scan TVs and High-Definition TVs that are not fully compatible with this unit, resulting in an unnatural picture when playing back a DVD VIDEO disc in the progressive scan mode. In this case, turn off the progressive scan feature on both the DVD system and your TV.

TIPS: Press **◀** to go back to the previous menu item. Press **SETUP** to exit the menu.

Getting Started (continued)

Step 6: Setting the SonoWave speakers

There are three parameters to adjust the SonoWave speakers: Room Acoustics, Speaker Distance and Listening Position. You can adjust the SonoWave speaker settings according to your room environment and setup for optimum performance.

- 1 Press and hold **SOUND** on the remote control to enter SonoWave speaker settings mode.
- 2 Use ◀▶ keys to select { **ROOM ACOUSTICS** } and press **OK**.
 - To return to the main SonoWave speaker settings selection, press ▲ or ▼ key.
- 3 Use ◀▶ keys to select the condition of the room and press **OK** to confirm.
 - { HARD } for concrete/glass walls.
 - { SOFT } for wooden walls.
- 4 Use ◀▶ keys to select { **SPEAKER DISTANCE** } and press **OK**.

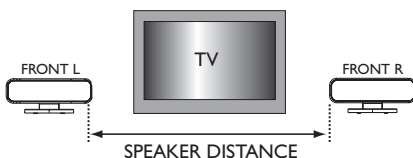

- 5 Use ◀▶ keys to select the distance between the two SonoWave speakers and press **OK** to confirm.
 - { NEAR } for distance less than 1 meter (3' 5").
 - { DEFAULT } for distance between 1 meter (3' 5") to 2.5 meters (7' 7").
 - { FAR } for distance more than 2.5 meters (7' 7").

- 6 Use ◀▶ keys to select { **LISTENING POSITION** } and press **OK**.

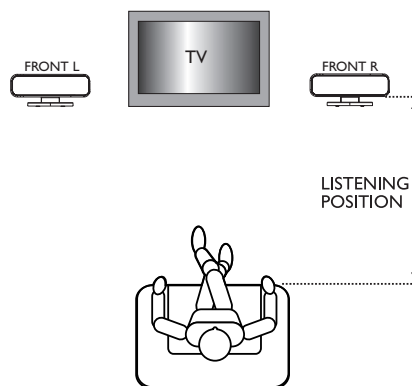

- 7 Use ◀▶ keys to select the distance between the listening position and the SonoWave speakers and press **OK** to confirm.
 - { NEAR } for distance less than 1.5 meters (4' 7").
 - { DEFAULT } for distance between 1.5 meters (4' 7") to 2.5 meters (7' 7").
 - { FAR } for distance more than 2.5 meters (7' 7").
- 8 The SonoWave speaker settings are now completed and the system will exit the setting automatically.

TIPS: The underlined option is the factory default setting.
Press ◀ to go back to the previous menu item. Press **SETUP** to exit the menu.

Disc Operations

Playable discs



Your DVD home theater system will play:

- Digital Versatile Discs (DVDs)
- Video CDs (VCDs)
- Super Video CDs (SVCDs)
- Finalized DVD Recordable (DVD±R), DVD Rewritable (DVD±RW)
- Audio Compact Discs (CDs)
- MP3/ Windows Media™ Audio discs, picture (Kodak, JPEG) files on CD-R(W)
 - ISO 9660/UDF format
 - JPEG resolution support up to 3072 x 2048
 - Supported sampling frequencies : 32 kHz, 44.1 kHz, 48 kHz
 - Supported Bit-rates : 32~256 (kbps), variable bit rates (average 128 kbps)
- DivX files on CD-R(W)/DVD±R(W):
 - DivX 3/4/5/6, DivX Ultra
 - Supports QPEL (Quarter Pixel).

Region Codes for DVD discs

DVD discs and players are designed with regional restrictions. Before playing a disc, make sure the disc is for the same region as your player. The regional code for this DVD system is indicated at the rear panel.

IMPORTANT!

- If the inhibit icon (Ø or X) appears on the TV screen when a button is pressed, it means the function is not available on the current disc or at the current time.
- Do not put any objects other than discs on the disc tray. Doing so may cause the disc player to malfunction.

Playing a disc

- 1 Press **SOURCE** repeatedly until "DISC" appears on the display panel (or press **DISC/USB** on the remote control).
- 2 Turn on the TV to the Video In channel for the DVD system (e.g. 'EXT', '0', 'AV').
→ You should see the blue DVD background screen on the TV.
- 3 Insert a disc into the disc slot.
→ Make sure the disc label is facing up. For double-sided discs, load the side which you want to play facing up.
→ When loading an 8cm (3") disc, slot into the middle of the disc loader.
- 4 Playback will start automatically.
→ See the following pages for more playback options and features.
- 5 To remove the disc, stop playback and press **EJECT** ▲.
- You can also press and hold the **STOP** ■ button on the remote control to eject the disc.

Helpful Hint:

- If you are having trouble playing a certain disc, remove the disc and try a different one. Improperly formatted discs will not play on this DVD system.

TIPS: Some discs cannot be played on this player due to the configuration and characteristics of the disc, or due to the condition of recording and authoring software that was used.

Disc Operations (continued)

Basic playback controls

Pausing playback

- During playback, press **▶||** (or **||** on the remote control).
 - While in pause mode, you can press **||** repeatedly to view the next still picture (for video playback only.)
 - To resume playback, press **▶||** (or **▶▶** on the remote control).

Selecting another track/chapter

- Press **◀◀/ ▶▶** or use the **numeric keypad (0-9)** to key in a track/chapter number.
 - If the repeat track mode is active, press **◀◀** again to replay the same track/ chapter.

Searching backward/forward

- Press and hold **◀◀/ ▶▶**.
 - While searching, press **◀◀/ ▶▶** repeatedly to decrease/increase the search speed.
 - To resume normal playback, press **▶||** (or **▶▶** on the remote control).

Stopping playback

- Press **■**.

Helpful Hint:

– This is a power-saving feature, the system will automatically switch to Eco Power standby mode if you do not press any buttons within 30 minutes after a disc has stopped playing.

Selecting various repeat/ shuffle functions

- While playing a disc, press **REPEAT** on the remote control repeatedly to choose a repeat play mode.

DVD

- RPT ONE (repeat chapter)
- RPT TT (repeat title)
- SHUFFLE (random play)
- RPT SHF (repeat random play)
- RPT OFF (exit repeat mode)

VCD/SVCD/CD

- RPT ONE (repeat track)
- RPT ALL (repeat disc)
- SHUFFLE (random play)
- RPT SHF (repeat random play)
- RPT OFF (exit repeat mode)

MP3/DivX/Windows Media™ Audio

- RPT ONE (repeat track)
- RPT ALL/FLD (repeat folder)
- SHUFFLE (random play)
- RPT OFF (exit repeat mode)

Helpful Hint:

– Repeat playback is not possible on VCDs when the PBC mode is turned on.

TIPS: The operating features described here might not be possible for certain discs. Always refer to the instructions supplied with the discs.

Disc Operations (continued)

Programming disc tracks

(not for Picture CD/MP3)

You can play the contents of the disc in the order you want by programming the playing order of the tracks.

- 1 Press **PROGRAM** on the remote control.
→ The programming menu appears.

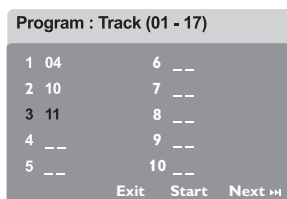

- 2 Use the **numeric keypad (0-9)** to enter a valid track/chapter number.
- 3 Use **◀▶▲▼** keys to move the cursor to the next position.
 - If there are more than ten total program tracks, select { **Next** } on the screen and press **OK** (or press **▶▶** on the remote control) to access the next programming page.
 - To remove the track/chapter from the programming menu, select the track/chapter and press **OK**.
- 4 Once complete, select { **Start** } on the screen and press **OK** to start playback.
→ Playback will start from the selected track under the programmed sequence.
- 5 To exit the program menu, select { **Exit** } in the menu and press **OK**.

Other playback features for video discs (DVD/VCD/SVCD)

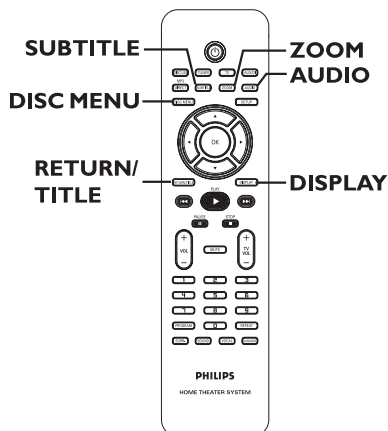

Using the Disc Menu

Depending on the disc format, a menu may appear on the TV screen once you load the disc.

To select a playback feature or item

- Use **◀▶▲▼** keys or **numeric keypad (0-9)** on the remote control, then press **OK** to start playback.

To access or remove the menu

- Press **DISC MENU** on the remote control.

TIPS: The operating features described here might not be possible for certain discs. Always refer to the instructions supplied with the discs.

Disc Operations (continued)

Viewing playback information

This DVD system can display the disc playback information (for example, title or chapter number, elapsed playing time, audio/subtitle language) and a number of operations can be done without interrupting disc playback.

- 1 During playback, press **DISPLAY**.
→ A list of available disc information appears on the TV.



- 2 Use **▲▼** keys to view the information and press **OK** to access.
- 3 Use the **numeric keypad (0-9)** to input the number/time or use **▲▼** keys to make the selection, then press **OK** to confirm.
→ Playback will change according to the chosen time or to the selected title/chapter/track.

Resuming playback from the last stopped point

This DVD system is able to resume disc playback from its last stopped point (only possible for the last 10 discs that were recorded without a menu).

- 1 Load one of the last 10 discs played.
- 2 While "LOADING" appears on the display panel, press **PLAY ▶** (or **▶||**) to start playback from the last stop point.

To cancel the resume mode

- Press **■** twice.

Zooming in

This option allows you to enlarge the picture on the TV screen and to pan through the enlarged picture.

- 1 During playback, press **ZOOM** on the remote control repeatedly to select a different zoom factor.
→ Use **◀▶▲▼** keys to move through the zoomed image.
→ Playback will continue.
- 2 Press **ZOOM** repeatedly to return to the original size.

Changing subtitle language (DVD only)

This operation works only on DVDs with multiple subtitle languages. You can change the language you want while playing a DVD.

- Press **SUBTITLE** repeatedly to select different subtitle languages.

TIPS: The operating features described here might not be possible for certain discs. Always refer to the instructions supplied with the discs.

Disc Operations (continued)

Changing sound track language

This operation works only on DVDs with multiple soundtrack languages, you can change the language you want while playing a DVD.

- Press **AUDIO** repeatedly to select the available audio languages.

For VCD – changing the audio channel

- Press **AUDIO** repeatedly to select the available audio channels provided by the disc (STEREO, MONO LEFT, MONO RIGHT or MIX MONO.)

Playback Control (VCD only)

Playback Control (PBC) playback allows you to play Video CDs interactively, following the menu on the display. This function can also be accessed via the 'Preference Page' menu.

For VCDs with Playback Control (PBC) feature (version 2.0 only)

- During playback, press **RETURN/TITLE** to return to the disc title menu or main menu.

Preview function (VCD/SVCD only)

This function allows you to preview the contents of a VCD/SVCD.

- 1 Press **DISC MENU**.

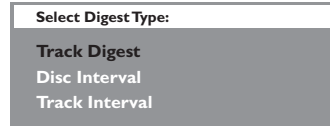

- 2 Use **▲▼** keys to select one of the following options and press **OK**.

{ Track Digest }

View six different tracks on one screen each time. It allows you to have a quick glance at all the tracks on the disc.

{ Disc Interval }

View the whole disc in six thumbnail pictures. It divides a disc into six portions at regular intervals and displays them on one screen.

{ Track Interval }

View the content of a single track in six thumbnail pictures. It divides a single track into six portions at regular intervals and displays them on one screen.

This option is only available during playback mode.

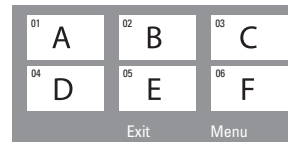

- To go to the previous or next page, press **◀◀ / ▶▶**.
 - To return to the main menu, select **{ Menu }** on the screen and press **OK**.
 - Press **OK** on the selected thumbnail picture to start playback from there.
- 3 To exit the preview menu, select **{ Exit }** on the screen and press **OK**.

TIPS: The operating features described here might not be possible for certain discs. Always refer to the instructions supplied with the discs.

Disc Operations (continued)

Playing an MP3/ JPEG/ Windows Media™ Audio disc

This DVD system can playback most of the MP3, JPEG and Windows Media™ Audio files recorded on a CD-R/RW disc or commercial CD.

Before you start ...

Turn on your TV to the correct Video In channel. See the section on “Finding the correct viewing channel”.

- 1 Insert a disc.
 - The disc reading time may exceed 30 seconds due to the complexity of the directory/file configuration.
 - The disc menu appears on the TV.

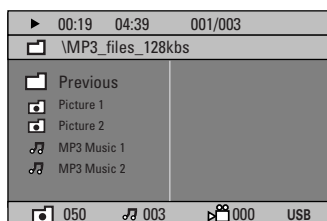

- 2 If the disc main menu contains various folders, use ▲▼ keys to select a desired folder and press **OK** to open the folder.
- 3 Use ▲▼ keys to select a track/file and press **OK** to start playback.
 - Playback will start from the selected file and continue through to the end of the folder.

During playback, you can;

- Press **◀◀/▶▶** to playback another track/file in the current folder.
- Press and hold **◀◀/▶▶** to fast reverse/forward search for a music track.
- To select another folder from the current disc, press ▲ to return to the root menu. Use ▲▼ keys to make your selection and press **OK** to confirm.
- Press **REPEAT** repeatedly to access various play modes.
- 4 To stop playback, press **■**.

Helpful Hint:

– To skip the folders menu when you load a MP3/JPEG disc, set the MP3/JPEG NAV setting in the Preference Setup Page to { Without Menu }.

TIPS: Some discs cannot be played on this player due to the configuration and characteristics of the disc, or due to the condition of recording and authoring software that was used.

Disc Operations (continued)

Playing a JPEG image file (slide show)

Before you start ...

Turn on your TV to the correct Video In channel. See the section on "Finding the correct viewing channel".

- Insert a Picture disc (Kodak Picture CD, JPEG).
 - For a Kodak disc, the slide show will begin automatically.
 - For a JPEG disc, the picture menu will appear on the TV. Press **PLAY** ► (or ►►) to start the slide-show playback.

Preview function

- 1 During playback, press ■.
 - 12 thumbnail pictures will be displayed on the TV.



- 2 Press ◀◀/ ▶▶ to display the other pictures on the previous/next page.
- 3 Use ◀▶▲▼ keys to highlight one of the pictures and press **OK** to start playback.
- 4 Press **DISC MENU** to return to Picture CD menu.

Zoom picture

- 1 During playback, press **ZOOM** repeatedly to select a different zoom factor.
- 2 Use ◀▶▲▼ keys to pan through the zoomed image.

Helpful Hint:

– This feature is not applicable for DivX disc.

Rotating/flipping the picture

- During playback, use ◀▶▲▼ keys to rotate/flip the picture on the TV.
 - ▲ : flip the picture vertically
 - ▼ : flip the picture horizontally
 - ◀ : rotate the picture counter-clockwise
 - ▶ : rotate the picture clockwise

Supported file format:

- The file extension has to be '*.JPG' and not '*.JPEG'.
- It can only display DCF-standard still pictures or JPEG pictures e.g. TIFF. It cannot play back moving pictures, Motion JPEG and other formats, or pictures in formats other than JPEG, or pictures associated with sound.
- It may require longer time for the DVD system to display the disc content on the TV due to the large number of songs/pictures compiled into one disc.
- Progressive JPEG files will take a longer time to display compared to baseline JPEGs.

TIPS: Some discs cannot be played on this player due to the configuration and characteristics of the disc, or due to the condition of recording and authoring software that was used.

Disc Operations (continued)

Playing MP3 music and JPEG pictures simultaneously

You can create a musical slide show if the disc contains both the MP3 music and JPEG picture files.

- 1 Insert an MP3 disc that contains music and pictures.
- 2 Select an MP3 track in the menu and press **PLAY ▶** (or **▶▶**) to start playback.
- 3 During MP3 music playback, use **◀▶▲▼** keys to select a picture folder from the disc menu and press **PLAY ▶** (or **▶▶**).
→ The picture files will be played back through to the end of the folder.
- 4 To stop simultaneous playback, press **DISC MENU** and followed by **■**.

Helpful Hints:

- It is normal to experience an occasional “skip” while listening to your MP3 disc.
- It is normal to experience an occasional pixelation during MP3/DivX playback due to poor clarity of digital contents during internet downloading.
- Only the first session of a multi-session CD will be played back.

Playing a DivX disc

This DVD system supports the playback of DivX movies which you can copy from your computer onto a CD-R/RW, DVD+R/+RW disc (see ‘General Setup Page - { DivX(R) VOD code }).

- 1 Insert a DivX disc.
- 2 Press **PLAY ▶** (or **▶▶**) to start playback.

During playback, you can;

- If multilingual subtitles are embedded on the DivX disc, you can press **SUBTITLE** to change the subtitle language while playing.
- Use **◀ / ▶** keys on the remote control to perform fast reverse/forward search.
- Press **DISPLAY** repeatedly until the Time Search menu appears, key in the time where playback should start and press **OK** to confirm.
→ Playback skips to the time entered.

Helpful Hints:

- Subtitle files with the following file name extensions (.srt, .smi, .sub, .ssa, .ass) are supported but do not appear on the file navigation menu.
- The subtitle file name has to be the same as the file name of the movie.
- The subtitle can only be displayed up to an average of 45 characters.

TIPS: Some discs cannot be played on this player due to the configuration and characteristics of the disc, or due to the condition of recording and authoring software that was used.

Disc Operations (continued)

Playing a Karaoke disc

Before you start ...

Turn on your TV to the correct Video In channel. See the section on 'Finding the correct viewing channel'.

- 1 Connect a microphone (not supplied) to the **MIC** socket on the front panel of the DVD main unit (as shown below).

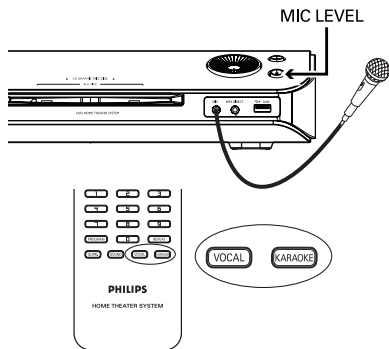

- 2 Insert a karaoke disc.
→ If the disc menu appears, use ▲▼ keys to make your selection and press **OK** to start playback.
 - 3 To turn off the vocal or change the sound channel of a karaoke disc, press **VOCAL** on the remote control repeatedly to toggle between various audio modes.
 - 4 Start enjoying the karaoke.
- While singing, you can set the microphone volume level by pressing the **MIC LEVEL** on the top panel followed by adjusting the Volume control.

Microphone setting

- 1 Press **KARAOKE** on the remote control to access 'Microphone Setup' page.

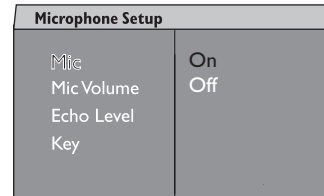

- 2 In 'Microphone Setup' page, use ▲▼ keys to select the option for microphone settings and press **OK** to confirm.

{ Mic }

– Use ▲▼ keys to turn on or off the karaoke microphone.

{ Mic Volume }

– Use ▲▼ keys to set the microphone volume level (00 ~ +20). Select '00' for minimum microphone volume setting.

{ Echo Level }

– Use ▲▼ keys to set the Echo Level (00 ~ +20). Select '00' for minimum echo level setting.

{ Key }

– Use ▲▼ keys to set the pitch level (-10~ +10) that matching your voice. Select '-10' for lowest possible tone and '+10' for highest tone. To return to original tone, select '00'.

USB Operations

Playing from USB flash drive or USB memory card reader

This DVD system is able to access and view the data files (JPEG, MP3 or Windows Media™ Audio) in the USB flash drive or USB memory card reader. Editing and copying the data are not possible.

- 1 Insert a USB flash drive or USB memory card reader into the USB port on the front panel.

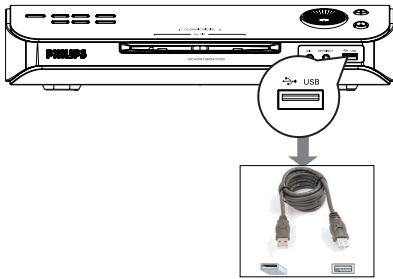

- 2 A message will appear on the TV for 5 (five) seconds when the device is detected.

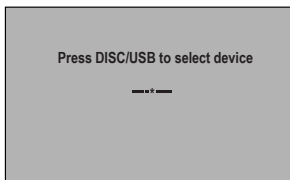

- 3 Press **DISC/USB** on the remote control to access the data in the drive.
 - The device numbers may vary from different card readers.
 - For the card reader, only one of the connected device can be accessed.
- During playback, you can press **DISC/USB** to return to the disc mode.

- 4 Before removing the USB device, press **■** to stop playback or press **DISC/USB** to switch to disc mode.

Helpful Hint:

– If the USB device does not fit into the USB port, a USB extension cable is required.

Compatibility of the USB device

- The USB port does not support the connection of other USB devices except USB flash drive or USB memory card readers.
- It is not possible to record/copy the data from the USB port to this DVD system.
- Copy-protected contents are not playable.

MP3 Direct Operations

Playing from a portable audio or HDD player

This DVD system is able to playback audio tracks from your portable audio or HDD player.

- 1 Use the supplied MP3 direct cable to connect between the 'headphone' output jack on your portable audio or HDD player and the **MP3 DIRECT** jack on the front panel of this DVD system.
→ The white cable is for the portable audio player.

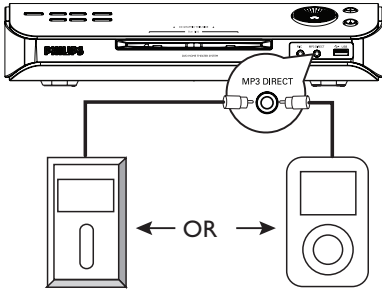

- 2 Press **MP3 DIRECT** on the remote control.
- 3 Start playback on your portable audio or HDD player.
- 4 To stop playback, press the STOP button on the portable audio or HDD player.

Helpful Hints:

- If you change the input source by pressing any of the source button (e.g. DISC/USB, TUNER,) the playback from the MP3 or HDD player will not stop automatically. .
- No copying of tracks on portable HDD to the USB drive.

DVD Setup Menu Options

Accessing the DVD setup menu

This DVD system setup is carried out via the TV, enabling you to customise the DVD system to suit your particular requirements.

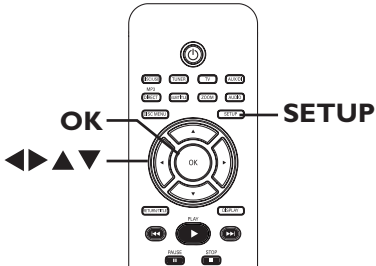

- 1 In 'DISC' mode, press **SETUP** on the remote control.
→ The setup menu appears.
- 2 Use ◀ ▶ keys to select one of the setup menu options and press **OK**.



- If you are not able to access the { Preference Page }, press **SETUP** to exit the menu. Then, press **STOP** (■) twice before you press the **SETUP** again.
- 3 Use ▲ ▼ keys to select a setup option and press ▶ to access
 - 4 Select the setting you wish to change and press **OK** to confirm and go back to the previously selected item.
→ Instructions and explanations of the options are provided in the following pages.
→ If the option in the menu is grayed out, that means the setting is not available or cannot be changed in the current state.
 - 5 To exit, press **SETUP**.

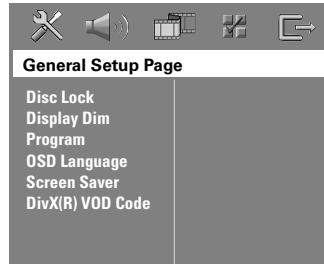

see page 38

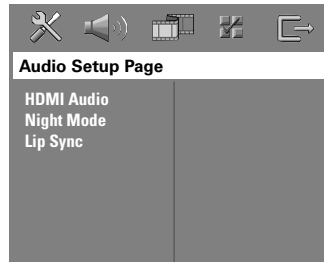

see page 39

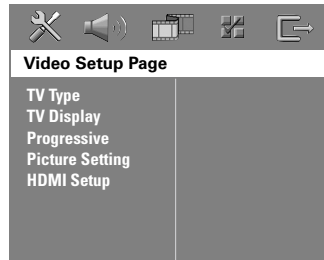

see pages 40~41

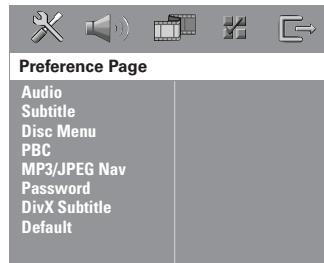

see pages 42~43

DVD Setup Menu Options (continued)

General Setup Page (underlined options are the factory default settings)

Disc Lock	<p>Not all discs are rated or coded by the disc maker. You can prevent a specific disc from playing by locking the disc. Up to 40 discs can be locked.</p> <p>{ Lock } – Selects this to block the playback of the current disc. Subsequent access to a locked disc requires a six-digit password. The default password is '136900' (see 'Preference Setup Page - { Password }').</p> <p>{ Unlock } – All discs can be played.</p>
Display Dim	<p>Selects the brightness of the DVD system display panel.</p> <p>{ 100% } – Full brightness.</p> <p>{ 70% } – Medium brightness.</p> <p>{ 40% } – Dimmest display.</p>
Program	<p>Access the track programming menu. See 'Programming disc tracks' chapter.</p>
OSD language	<p>Selects the preferred language for the DVD system on-screen display menu.</p>
Screen Saver	<p>The screen saver prevents damage to the TV screen by avoiding exposure to a static image for too long.</p> <p>{ On } – Switches to TV screen saver mode when playback has been stopped or paused for more than 15 minutes.</p> <p>{ Off } – Turns off the screen saver function.</p>
DivX(R) VOD code	<p>Philips provides you with the DivX[®] VOD (Video On Demand) registration code that allows you to rent and purchase videos using the DivX[®] VOD service. Press ► to see the registration code and press OK to exit.</p> <p>Use the registration code to purchase or rent the videos from DivX[®] VOD service at www.divx.com/vod. Follow the instructions and copy the video from your computer onto a CD-R/RW disc for playback on this DVD system.</p> <p>Note: All the downloaded videos from DivX[®] VOD can only be played back on this DVD system. For more information, visit us at www.divx.com/vod.</p>

DVD Setup Menu Options (continued)

Audio Setup Page (underlined options are the factory default settings)

HDMI Audio

This setting is only required if you are using the DVD system's HDMI OUT jack to connect your TV or other display device (see 'Option4: Connecting to a HDMI-compatible TV').

Note: It may take a while for the DVD system and the input device to communicate and initialize.

- { Off } – Select this if the playback audio format is not supported by HDMI connection (e.g. projector, SACD). It will turn off the HDMI audio output.
- { **PCM** } – Select this to downmix the audio signals to linear-PCM (2-channel).
- { **All** } – Select this to enjoy the multi-channel audio output through the HDMI connection.

Note: It is not possible to listen to SACDs or copy-controlled DVD-Audio CPPM (Content Protection for Playable Media) sources using the HDMI connection.

Night Mode

This mode optimizes playback of sound at low volume. High volume outputs will be softened and low volume outputs will be enhanced to an audible level. This feature is only applicable for DVD video discs with Dolby Digital mode.

- { **On** } – Turns on night mode.
- { Off } – Turns off night mode feature. Selects this to enjoy the surround sound with its full dynamic range.

Lip Sync

This feature allows you to adjust the audio delay times if the video playback is slower than the audio output streams, hence resulting in lip-sync.

Access the lip sync setup menu. Use ◀ ▶ keys to set the delay times (0 ~ 200 ms) for the audio output.

DVD Setup Menu Options (continued)

Video Setup Page (underlined options are the factory default settings)

TV Type

Selects the colour system that matches the connected TV. It will enable playback of a different type of disc (PAL or NTSC disc) on this DVD system.

- { PAL } – For PAL-system TV.
- { NTSC } – For NTSC-system TV.
- { Multi } – For TV that is compatible with both PAL and NTSC.

TV Display

The picture shape can be adjusted to fit your TV.

{ 4:3 Letter Box } – For a 'wide-screen' display with black bars on the top and bottom.

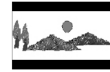

{ 4:3 Pan Scan } – For a full-height picture with the sides trimmed.



{ 16:9 Wide Screen } – For wide-screen TV (frame ratio 16:9).



Progressive

Before enabling the progressive scan feature, you must ensure that your TV can accept progressive signals (a progressive scan TV is required) and that you have connected this DVD system to your TV using the Y Pb Pr (see 'Option 3: Connecting to a Progressive Scan TV or component video input').

- { On } – Turns on progressive scan mode.
Read the instructions on the TV and confirm your action by pressing **OK** on the remote control.
- { Off } – Disables the progressive scan mode.

Note: If no picture appears, wait for 15 seconds for auto recovery. Otherwise, turn off the progressive scan as below:

- 1) Press **EJECT**.
- 2) Press **◀** on the remote control.
- 3) Press **MUTE** on the remote control.

Picture Setting

This DVD system provides three predefined sets of picture color settings and one personal setting which you can define yourself.

- { Standard } – Original color setting.
- { Bright } – Vibrant color setting.
- { Soft } – Warm color setting.
- { Personal } – Selects this to personalize the picture color setting. Use **◀ ▶** keys to adjust to the setting that best suits your personal preference and press **OK** to confirm. For an average setting, select { 0 }.

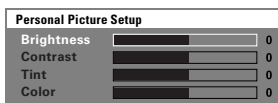

DVD Setup Menu Options (continued)

Video Setup Page (underlined options are the factory default settings)

HDMI Setup

It provides the picture settings to enhance the appearance and picture quality for disc playback. This feature is only applicable if you have connected this DVD system to a HDMI-compatible TV/device.

{ **HDMI Video** } – Selects a suitable video resolution depending on the capability of the connected TV/device to further enhance the HDMI video output.

- { **480p** }
Progressive output in 480 lines for NTSC TV.
- { **576p** }
Progressive output in 576 lines for PAL TV.
- { **720p** } - (if a HDMI TV is connected)
Progressive output upscale to 720 lines.
- { **1080i** } - (if a HDMI TV is connected)
Interlaced output upscale to 1080 lines.
- { **Auto** }
The video output will automatically follow the display's supported resolution.

Note: If no display appears on the TV due to unsupported resolution, use the composite video cable to connect the DVD system and your TV. Turn on your TV to the correct input channel for the composite video and adjust the resolution setting to 480p/576p.

{ **Wide Screen Format** } – Selects a suitable screen display.

This feature is only available if you have selected { **TV Display - 16:9 Wide Screen** }.

- { **Superwide** }
Selects this to display the 4:3 picture disc on the wide-screen TV with non-linear stretching (center position of the screen is stretched less than the side).
- { **4:3 Pillar Box** }
Selects this to display 4:3 picture disc on the wide-screen TV without stretching. Black bars will be shown on the both sides of the TV screen.
- { **Off** }
No aspect ratio adjustment is made when this option is selected.

Note: The { **Wide Screen Format** } feature will be disabled if your HDMI TV has been preset to { **480p** } or { **576p** } settings.

DVD Setup Menu Options (continued)

Preference Setup Page (underlined options are the factory default settings)

Audio	Selects the preferred audio language for DVD playback.
Subtitle	Selects the preferred subtitle language for DVD playback.
Disc Menu	Selects the preferred disc menu language for DVD playback. Note: If the selected audio/subtitle/disc menu language is not available on the DVD, the disc's default language will be used instead.
PBC	Play Back Control feature is applicable for VCD/SVCD only. It allows you to play Video CDs (2.0) interactively, following the menu on the display. { <u>On</u> } – The index menu (if available) will appear on the TV when you load a VCD/SVCD. { <u>Off</u> } – The VCD/SVCD will skip the index menu and playback directly from the beginning.
MP3/JPEG Nav	MP3/JPEG Navigator can only be set if the disc is recorded with a menu. It allows you to select different display menus for easy navigation. { <u>Without Menu</u> } – Displays all the files contained in the MP3/Picture disc. { <u>With Menu</u> } – Displays the folder menu of the MP3/Picture disc. Note: This DVD system can only display 650 files/folder in the directory.
Password	The password is used for the Disc Lock. Enter your six-digit password to play a locked disc or when prompted for a password. The default password is '136900'. To change the password: 1) Press OK to access the change password menu. 2) Use the numeric keypad 0-9 on the remote control to enter your existing six-digit password at { Old Password }. Note: When doing this for the first time or if you forget your existing password, key in '136900'. 3) Enter the new six-digit password at { New Password }. 4) Enter the new six-digit password again at { Confirm PWD }. 5) Press OK to confirm and exit the menu.

DVD Setup Menu Options (continued)

Preference Setup Page (underlined options are the factory default settings)

DivX Subtitle

Selects the font type that supports the recorded DivX subtitle.

- { **Standard** } – Displays a standard list of Roman subtitle fonts provided by this DVD system.
- { **Central Europe** } – Displays Central Europe fonts.
- { **Cyrillic** } – Displays Cyrillic fonts.
- { **Greek** } – Displays Greek subtitle fonts.
- { **Chinese (Simp)** } – Displays Simplified Chinese fonts.
- { **Korean** } – Displays Korean fonts.

Default

This feature enables you to reset all the setup menu options and your personal settings to the factory defaults, except your password for the Disc Lock. Press **OK** to confirm the default reset.

Tuner Operations

IMPORTANT!

Make sure the FM and MW antennas are connected.

Tuning to radio stations

- 1 Press **SOURCE** repeatedly until "FM" appears on the display panel (or press **TUNER** on the remote control).
- 2 Press ◀ / ▶ briefly on the remote control to start tuning.
→ "SEARCH > or <" will appear on the display panel until a radio station with sufficient signal strength is found.
- 3 Repeat step 2 if necessary until you find the desired radio station.
- 4 To fine-tune the reception of a weak station, press ▲ / ▼ briefly and repeatedly until optimal reception is found.

Presetting radio stations

You can store up to 40 FM and 20 MW preset radio stations in the memory. There are three different ways to program the radio stations:

- Using auto install (for first time setup only)
- Using automatic preset
- Using manual preset

Helpful Hints:

- The system will exit presetting mode if no button is pressed within 20 seconds.
- If no stereo signal is detected or less than 5 (five) stations are detected during tuner installation, "PLEASE CHECK ANTENNA" appears.

Using auto install

This feature is only applicable for first time radio station programming. You will be prompted to install the radio stations when you access the tuner mode. With one touch of button, all the available radio stations will be stored automatically.

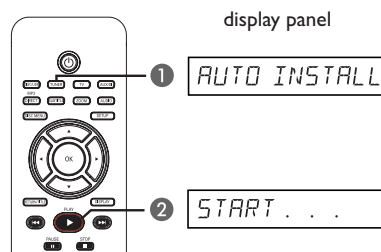

- 1 Press **TUNER**.
→ "AUTO INSTALL PRESS PLAY" appears.
- 2 Press **PLAY** ▶ until "START ..." appears on the display panel.
→ The system will start searching from the FM band followed by the MW band.
→ All the available radio stations with strong signal will be stored automatically.
→ Once complete, the last tuned radio station will be played back.

Tuner Operations (continued)

Using automatic preset

Use automatic presetting to store or reinstall all the preset radio stations.

- 1 Press **TUNER** to select “FM” or “MW” band.
- 2 Press and hold **PROGRAM** until “START ...” appears on the display panel.
→ All previously stored radio stations will be replaced.

Using manual preset

Use manual presetting to store your favorite radio stations.

- 1 Tune to your desired radio station (see “Tuning to radio stations”).
- 2 Press **PROGRAM**.
- 3 Use **◀◀/ ▶▶** keys to select a preset number that you want to store the current radio station.
- 4 Press **PROGRAM** to store.

Selecting a preset radio station

- 1 Press **TUNER** to select “FM” or “MW” band.
- 2 Use **◀◀/ ▶▶** keys to select a preset number (or use the numeric keypad on the remote control.)
→ The waveband, preset number followed by the radio frequency will appear on the display panel.

Deleting a preset radio station

- 1 In tuner mode, use **◀◀/ ▶▶** keys to select a preset radio station.
- 2 Press and hold **■** until “FM/MW X DELETED” appears.
→ “X” is the preset number.
→ The radio station continues to play but has been deleted from the preset list.
→ The rest of the preset radio stations remain unchanged.

Changing tuning grid

(not available for all versions)

In some countries, the frequency step between adjacent channels in the MW/FM band is 9 kHz/ 50 kHz (10 kHz/ 100 kHz in some areas).

IMPORTANT!

Changing the tuning grid will erase all previously stored preset radio stations.

- 1 Press **SOURCE** to select “FM” or “MW”.
- 2 Press **STANDBY ON** to switch the DVD system to standby mode.
- 3 Press **STANDBY ON** again to power up the DVD system, followed by **◀◀** key on the front panel.
→ The display will show “GRID 9” or “GRID 10”.

Helpful Hint:

– GRID 9 and GRID 10 indicate that the tuning grid is in step of 9 kHz and 10 kHz respectively.

Sound and Volume Controls

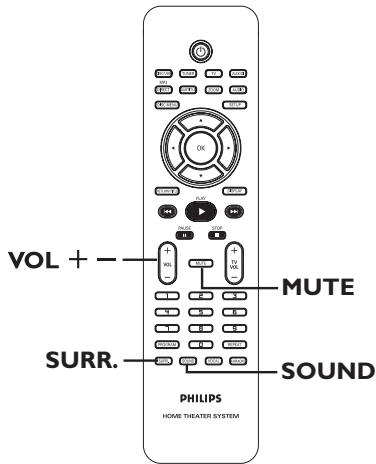

Selecting surround sound

- Press **SURR.** to select : DOLBY+PL II (multi-channel) or STEREO.
 - The availability of the various surround sound modes depends on the sound available on the disc.
 - The available output modes for Multi-channel include: Dolby Digital, DTS (Digital Theater Systems) Surround and Dolby Pro Logic II.
 - Stereo broadcasts or recordings will produce some surround channel effects when played in a surround mode.

Helpful Hint:

– You are not able to select the surround sound mode if the system setup menu is turned on.

Selecting digital sound effects

Select a preset digital sound effect that matches your disc's content or that optimizes the sound of the musical style you are playing.

- Press **SOUND** to select the available sound effect.

When playing movie discs or in TV mode, you can select : CONCERT, DRAMA, ACTION or SCI-FI.

When playing music discs or while in TUNER or AUX/DI mode, you can select : CLASSIC, JAZZ, ROCK or DIGITAL.

Helpful Hint:

– For flat sound output, select CONCERT or CLASSIC.

Volume control

- Press **VOL +/–** on the remote control to increase or decrease the volume level.
 - “VOL MIN” is the minimum volume level and “VOL MAX” is the maximum volume level.

To turn off the volume temporarily

- Press **MUTE** on the remote control.
 - Playback will continue without sound and “MUTE” appears.
 - To restore the volume, press **MUTE** again, or increase the volume level.

Software upgrades

Periodically Philips will issue software upgrades to enhance your user experience.

Before you start ...

Check the current software version of this DVD system:

- 1) Press **EJECT** .
- 2) Press **DISPLAY** on the remote control.

- ① Visit the Philips website 'www.philips.com/support' to check the availability of the latest software upgrade. Download the software to a CD-R.
- ② Insert the CD-R to the disc slot.
→ The software will start to install on the recorder automatically.

IMPORTANT!





Power supply must not be interrupted during upgrade!

Troubleshooting

WARNING

Under no circumstances should you try to repair the system yourself, as this will invalidate the warranty. Do not open the system as there is a risk of electric shock.

If a fault occurs, first check the points listed below before taking the system for repair. If you are unable to solve a problem by following these instructions, consult your dealer or Philips for help.

Problem (General)	Solution
No power.	<ul style="list-style-type: none"> – Check if the AC power cord is properly connected. – Press the  (STANDBY ON) on the front of the DVD system to turn on the power.
No picture.	<ul style="list-style-type: none"> – Refer to your TV's manual for correct Video In channel selection. Change the TV channel until you see the DVD screen. – Press the DISC/USB button to select disc mode. – If this happens when you are turning on the progressive scan feature, wait for 15 seconds for the auto recovery or turn off the progressive scan as below: <ol style="list-style-type: none"> 1) Press EJECT. 2) Press  on the remote control. 3) Press MUTE on the remote control.
Completely distorted picture or black/white picture.	<ul style="list-style-type: none"> – If this happens when you are changing the setting of the 'TV TYPE', wait for 15 seconds for the auto recovery. – Check the video connection. – Sometimes a small amount of picture distortion may appear. This is not a malfunction. – Clean the disc.
No sound or distorted sound.	<ul style="list-style-type: none"> – Adjust the volume. – Check the speaker connections and settings. – Make sure that the audio cables are connected and press the SOURCE button to select the correct input source (for example, TV or AUX/DI) to choose the device that you want to hear through the DVD system.
No surround sound effect from the speakers.	<ul style="list-style-type: none"> – Press the SURR. button to select a correct surround sound setting. – Make sure that the source you are playing is recorded or broadcast in surround sound (DTS, Dolby Digital, etc.).
The remote control does not function properly.	<ul style="list-style-type: none"> – Select the source you want to play (for example, DISC/USB or TUNER) before pressing the function button (,  / ). – Reduce the distance between the remote control and the system. – Replace the batteries with new ones. – Point the remote control directly toward the IR sensor. – Check that the batteries are loaded correctly.

Troubleshooting (continued)

Problem (Playback)	Solution
The DVD system does not start playback.	<ul style="list-style-type: none">– Insert a readable disc with the playback side facing down. The DVD+R/CD-R must be finalized.– Check the disc type, color system (PAL or NTSC) and region code.– Check for any scratches or smudges on the disc.– Press SETUP to turn off the system setup menu screen.– You may need to enter the password in order to change the parental control rating level or to unlock the disc for playback.– Moisture may have condensed inside the system. Remove the disc and leave the system turned on for about an hour.
The aspect ratio of the screen cannot be changed even though you have set the TV display.	<ul style="list-style-type: none">– The aspect ratio is fixed on the DVD disc.– Depending on the TV, it may not be possible to change the aspect ratio.
Cannot activate some features such as Angles, Subtitles, or multi-language Audio.	<ul style="list-style-type: none">– The features may not be available on the DVD.– Changing the language for the sound or subtitle is prohibited on this DVD.
Not able to select some items in the setup/system menu.	<ul style="list-style-type: none">– Press STOP button twice before selecting the system setup menu.– Depending on the disc availability, some menu items cannot be selected.
Unable to play DivX movies.	<ul style="list-style-type: none">– Check that the DivX file is encoded in 'Home Theater' mode with DivX certified encoder.
Radio reception is poor.	<ul style="list-style-type: none">– If the signal is too weak, adjust the antenna or connect an external antenna for better reception.– Increase the distance between the system and your TV or VCR.– Tune in to the correct frequency.– Place the antenna further away from any equipment that may be causing the interference.
The DVD system does not work.	<ul style="list-style-type: none">– Disconnect the power cord from the power outlet for a few minutes. Reconnect the power cord and try to operate again as usual.
The disc in the disc slot cannot be ejected.	<ul style="list-style-type: none">– Press and hold the STOP button on the remote control followed by pressing the digit keys '2', '5' and '9.'

Troubleshooting (continued)

English

Problem (USB/HDMI/MP3 Direct)	Solution
The contents of the USB flash drive cannot be read.	<ul style="list-style-type: none">- The USB flash drive format is not compatible with the system.- Drive is formatted with a different file system which is not supported by this DVD system (e.g. NTFS).
Slow operation of the USB flash drive.	<ul style="list-style-type: none">- Large file size or high memory USB flash drive takes longer time to read and display on the TV.
No HDMI audio output.	<ul style="list-style-type: none">- You will not hear any sound from the HDMI output if the source device is only DVI/HDCP (High-bandwidth Digital Content Protection)-compatible.- It is not possible to output SACD or copy-controlled DVD-Audio sources from the HDMI connection.
No HDMI video output.	<ul style="list-style-type: none">- HDMI connection can only be made to HDMI-equipped devices with HDCP (High Bandwidth Digital Content Protection). If you wish to connect to a DVI connector (equipped with HDCP,) you will need a separate adaptor (DVI to HDMI).- Make sure the resolution of this DVD system matches the device you have connected using the HDMI. See HDMI setting.

Specifications

English

AMPLIFIER

Output power: 500 W / 6000 W PMPO
Frequency Response: 20 Hz – 20 kHz / –3 dB
Signal-to-Noise Ratio: > 65 dB (CCIR)
Input Sensitivity
- AUX In: 1000 mV
- TV In: 500 mV
- Digital In: 500 mV

TUNER

Tuning Range: FM 87.5–108 MHz (50kHz)
MW 531–1602 kHz (9kHz)
MW 530–1700 kHz (10kHz)
26 dB Quieting
Sensitivity: FM 20 dB, MW 4 μ V/m
Image Rejection Ratio: FM 25 dB, MW 28 dB
IF Rejection Ratio: FM 60 dB, MW 45 dB
Signal-to-Noise Ratio: FM 60 dB, MW 40 dB
AM Suppression Ratio: FM 30 dB
Harmonic Distortion: FM Mono 3%
FM Stereo 3%
MW 5%
Frequency Response FM 180 Hz–10 kHz / \pm 6 dB
Stereo Separation FM 26 dB (1 kHz)
Stereo Threshold FM 23.5 dB

DISC SECTION

Laser Type Semiconductor
Disc Diameter 12cm / 8cm
Video Decoding MPEG-1 / MPEG-2 /
/ DivX 3/4/5/6, Ultra
Video DAC 12 Bits
Signal System PAL / NTSC
Video Format 4:3 / 16:9
Video S/N 60 dB
Composite Video
Output 1.0 Vp-p, 75 Ω
S-Video Output Y - 1.0 Vp-p, 75 Ω
C - 0.286 Vp-p, 75 Ω
Audio DAC 24 Bits / 192 kHz
Frequency Response 4 Hz–20 kHz (44.1 kHz)
4 Hz–22 kHz (48 kHz)
4 Hz–44 kHz (96 kHz)
PCM IEC 60958
Dolby Digital IEC 60958, IEC 61937
DTS IEC 60958, IEC 61937

MAIN UNIT

Power Supply Rating: 110~127 V / 220~240 V
50/60 Hz switchable
Power Consumption: 100 W
Eco Standby power: < 1 W
Dimensions: 340 x 70 x 330 (mm)
(w x h x d)
Weight: 3.5 kg

SonoWave SPEAKERS

System: Full range satellite closed-box system
Impedance: 8 Ω
Speaker drivers: 3" full range speaker
Frequency response: 120 Hz – 20 kHz
Dimensions: 305 x 122 x 96 (mm)
(w x h x d)
Weight: 2 kg/each

SUBWOOFER

Impedance: 4 Ω
Speaker drivers: 203 mm (8") woofer
Frequency response: 30 Hz – 120 Hz
Dimensions: 220 x 370 x 470 (mm)
(w x h x d)
Weight: 7 kg

Specifications subject to change without prior notice.

Glossary

Analog: Sound that has not been turned into numbers. Analog sound varies, while digital sound has specific numerical values. These jacks send audio through two channels, the left and right.

Aspect ratio: The ratio of vertical and horizontal sizes of a displayed image. The horizontal vs. vertical ratio of conventional TVs is 4:3, and that of wide-screens is 16:9.

AUDIO OUT jacks: Red and white jacks on the back of the unit that send audio to another system (TV, Stereo, etc.).

Bit Rate: The amount of data used to hold a given length of music; measured in kilobits per second, or kbps. Or, the speed at which you record. Generally, the higher the bit rate, or the higher the recording speed, the better the sound quality. However, higher bit rates use more space on a disc.

Chapter: Sections of a picture or a music piece on a DVD that are smaller than titles. A title is composed of several chapters. Each chapter is assigned a chapter number enabling you to locate the chapter you want.

Disc menu: A screen display prepared for allowing a selection of images, sounds, subtitles, multi-angles, etc to be recorded on a DVD.

DivX: The DivX code is a patent-pending, MPEG-4 based video compression technology, developed by DivXNetworks, Inc., that can shrink digital video to sizes small enough to be transported over the internet, while maintaining high visual quality.

Dolby Digital: A surround sound system developed by Dolby Laboratories containing up to six channels of digital audio (front left and right, surround left and right, center and subwoofer).

Dolby Surround Pro Logic II: It is an improved matrix decoding technology that provides better spatiality and directionality on Dolby Surround program material, provides a convincing three dimensional sound field on conventional stereo music recordings and is ideally suited to bring the surround experience to automotive sound. While conventional surround programming is fully compatible with Dolby Surround Pro Logic II decoders, soundtracks will be able to be encoded specifically to take full advantage of Pro Logic II playback, including separate left and right surround channels. (Such material is also compatible with conventional Pro Logic decoders).

DTS: Digital Theater Systems. This is a surround sound system, but it is different from the Dolby Digital. The formats were developed by different companies.

HDMI: High-Definition Multimedia Interface (HDMI) is a high-speed digital interface that can transmit uncompressed high definition video and digital multi-channel audio. It delivers perfect picture and sound quality, completely free from noise. HDMI is fully backward-compatible with DVI. As required by the HDMI standard, connecting to HDMI or DVI products without HDCP (High-bandwidth Digital Content Protection) will result in no Video or Audio output.

HDCP (High-bandwidth Digital Content Protection) is a specification that provides a secure transmission of digital contents between different devices (to prevent unauthorized copyright).

JPEG: A very common digital still picture format. A still picture data compression system proposed by the Joint Photographic Expert Group, which features a small decrease in image quality in spite of its high compression ratio.

Glossary (continued)

MP3: A file format with a sound data compression system. "MP3" is the abbreviation of Motion Picture Experts Group 1 (or MPEG-1) Audio Layer3. By using the MP3 format, one CD-R or CD-RW can contain about 10 times more data than a regular CD.

Multichannel: DVDs are formatted to have each sound track constitute one sound field. Multichannel refers to a structure of sound tracks having three or more channels.

Parental control: Limits Disc play according to the age of the users or the limitation level in each country. The limitation varies from disc to disc; when it is activated, playback will be prohibited if the software's level is higher than the user-set level.

Playback control (PBC): Refers to the signal recorded on video CDs or SVCDs for controlling playback. By using menu screens recorded on a Video CD or SVCD that supports PBC, you can enjoy interactive playback and searching.

Progressive Scan: The progressive scan displays twice the number of frames per second than in an ordinary TV system. It offers higher picture resolution and quality.

Region code: A system allowing discs to be played only in the region designated. This unit will only play discs that have compatible region codes. You can find the region code of your unit by looking at the product label. Some discs are compatible with more than one region (or ALL regions).

Surround: A system for creating realistic three dimensional sound fields full of realism by arranging multiple speakers around the listener.

Title: The longest section of a movie or music feature on DVD. Each title is assigned a title number, enabling you to locate the title you want.

VIDEO OUT jack: Yellow jack on the back of the DVD system that sends the DVD picture video to a TV.

Frequently Asked Questions (USB)

Why does it take so long to display the contents on my USB device?

- This could be due to the large numbers of files (>500 files/folders) or size of the files (>1MB).
- There could be other non-supported files in the device that the system is trying to read/display.

What if un-supported devices (e.g. USB mouse, keyboards) are plugged into the system?

- The device may cause the system to be unstable. Remove the unsupported device and unplug the mains cord. Wait for a few minutes before reconnecting the mains cord and power on the system again.

What happens when I plug in a USB HDD?

- HDD is not supported as the large storage capacity makes navigation very difficult. Transfer the music files (mp3) and photos (jpg) into a flash drive.

Why does the system fail to detect my USB portable music player?

- The portable music player may require propriety software that is bundled with our system in order to access the contents (eg. playlist).

What types of file does the system support?

- We support only FAT16 and FAT32, not NTFS.

Why does the file name appear to be different from what was displayed on my computer (e.g. from “Good Bye. jpg” to “Good_B~1.jpg”)?

- The length of the file name is restricted by the file system of the device (FAT16), which only supports eight (8) characters.
- The computer may be able to display the full file name as the operating system can convert the file system.

Is simultaneous USB and Disc playback possible?

- Not possible due to memory limitation. In addition, a different user interface will be needed in order to function and in order to be simple enough to use.

Why can't I rotate the pictures in my device?

- In order to rotate the pictures in the USB device, a “special” file in the jpeg picture called EXIF must be embedded. This EXIF information may have not been created by the USB device or removed when you edit or copy the picture from other devices using editing programs.

Why can't the system play some of my music files, photos or movies?

- The music files may not be playable because of different formats and encoding bit-rates. Similarly, the photos may be of low resolution or too high resolution for the system to support.

English