

# Portable DVD Player

PET714

PET718

Register your product and get support at  
[www.philips.com/welcome](http://www.philips.com/welcome)

User manual



# PHILIPS

1

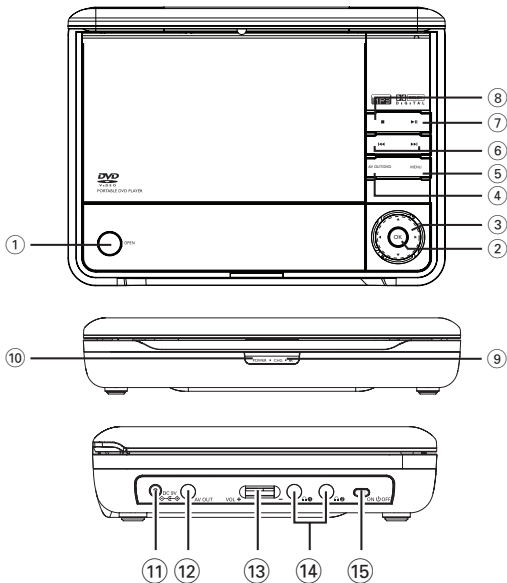

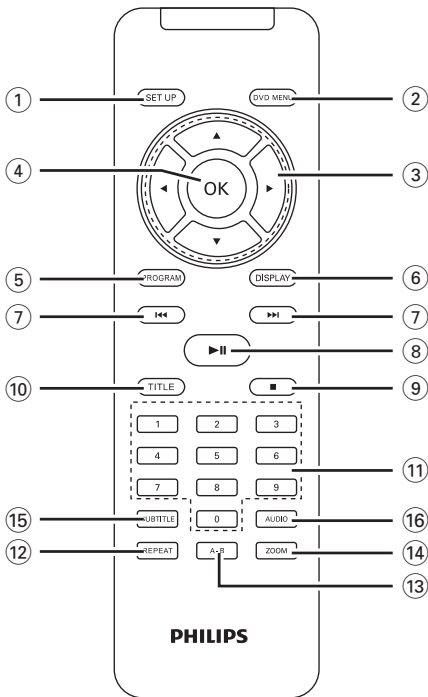

**Congratulations on your purchase and welcome to Philips! To fully benefit from the support that Philips offers, register your product at [www.philips.com/welcome](http://www.philips.com/welcome).**



### Main unit controls ( see figure 1 )

- ① **OPEN** .....Open the disc door to insert or remove disc.
- ② **OK** .....Confirm a selection.
- ③ **▲, ▼, ◀, ▶** .....Navigate in a menu.  
.....(◀ / ▶) search backward/forward in a disc at different speeds.
- ④ **AV OUT/DVD** .....Switch between DVD and AV OUT modes.
- ⑤ **MENU** .....Enter or exit the disc contents menu.
- ⑥ **◀◀ / ▶▶** .....Skip to the previous/next chapter, track or title.
- ⑦ **▶||** .....Start or interrupt playback.
- ⑧ **■** .....Stop playback or erase a program.
- ⑨ **IR**.....Remote sensor.
- ⑩ **POWER and CHG**..Power and charge indicator.









### Left of player ( see figure 1 )

- ⑪  .....Power supply socket.
- ⑫ **AV OUT**.....Audio/Video output jack.

## FUNCTIONAL OVERVIEW

- ⑬  VOLUME .....Volume control.
- ⑭  1  2 .....Headphone jacks.
- ⑮ **ON/OFF**.....Switch the power on/off.

### Remote controls ( see figure )

- ① **SETUP** .....Enter or exit the system menu.
- ② **DVD MENU** .....Enter or exit the disc contents menu.
- ③ , , ,  .....Navigate in a menu.  
.....( / ) search backward/forward in a disc at different speeds.
- ④ **OK**.....Confirm a selection.
- ⑤ **PROGRAM**.....Enter the program menu.
- ⑥ **DISPLAY** .....Display information on TFT during playback.
- ⑦ **PREV/NEXT**  /  Skip to the previous/next chapter, track or title.
- ⑧ **PLAY/PAUSE**  ..Start or interrupt playback.

## REMOTE CONTROL

- ⑨ **STOP ■** .....Stop playback or erase a program.
- ⑩ **TITLE** .....Display the disc title
- ⑪ **Numeric Keypad (0-9)**...Input numbers.
- ⑫ **REPEAT** .....Repeat a chapter/track/title.
- ⑬ **A-B**.....Repeat playback of a specific section on a disc.
- ⑭ **ZOOM**.....Enlarge or reduce a picture or active image on the TFT.
- ⑮ **SUBTITLE** .....Select a subtitle language.
- ⑯ **AUDIO** .....Select an audio language when playing a DVD disc or select an audio mode (Stereo, Mono-Left or Mono-Right) when playing a VCD/CD disc.

### **CAUTION**

*Use of controls or adjustments or performance of procedures other than herein may result in hazardous radiation exposure or other unsafe operation.*

# INTRODUCTION

## Your portable DVD player

Your portable DVD player plays digital video discs conforming to the universal DVD Video standard. With it, you will be able to enjoy full-length movies with true cinema picture quality, and stereo or multichannel sound (depending on the disc and on your playback set-up).

The unique features of DVD-Video, such as selection of soundtrack and subtitle languages, and of different camera angles (again depending on the disc), are all included.

What's more, parental lock lets you decide which discs your children will be able to see. You will find your player remarkably easy to use with the On-Screen Display and player display in combination with the remote control.

## Unpacking

- Portable DVD player
- Car adaptor (12V)
- User Manual
- Quick Start Guide
- AC power adaptor, DSA-9W-09 F (DVE) or AY4132 (PHILIPS) for PET714 only  
DSA-20R-12F (DVE) for PET718 only
- Remote Control
- Audio / Video cable
- Warranty

## Placement

- Place the player on a firm, flat surface.
- Keep away from domestic heating equipment and direct sunlight.
- If the player cannot read CDs/DVDs correctly, try using a commonly available cleaning CD/DVD to clean the lens before taking the player to be repaired. Other cleaning methods may destroy the lens.
- Always keep the disc door closed to avoid dust on the lens.
- The lens may cloud over when the player is suddenly moved from cold to warm surroundings. It is then not possible to play a CD/DVD. Leave the player in a warm environment until the moisture evaporates.

# INTRODUCTION

## About Built-in Rechargeable Battery

### Precautions related to battery recharge

- 1 Once the battery is fully discharged, immediately recharge it (regardless of whether you plan to use the battery or not) in order to maximize the battery life. When the power is low, the battery icon will be shown on the upper-left corner of the TFT for warning.
- 2 To charge the battery, please directly connect this DVD player to AC mains and the charge indicator will turn on.

### Using and maintaining your rechargeable batteries

- 1 Please make sure you always use only the AC adapter included with the player to recharge your batteries.
- 2 Recharge efficiency will degrade when the environmental temperature drops below 50°F (10°C) or exceed 95°F (35°C).
- 3 The lasting time of the fully charged battery when a headphone is connected to the DVD player is approximately 2 hours.

## Playable disc formats

In addition to DVD-Video disc, you will also be able to play all Video CDs and audio CDs (including CDR, CDRW, DVD±R and DVD±RW).

### DVD-Video

Depending on the material on the disc (a movie, video clips, a drama series, etc.) these discs may have one or more Titles, and each Title may have one or more Chapters. To make access easy and convenient, your player lets you move between Titles, and also between Chapters.



### CD with JPEG files

You can also view JPEG still photos on this player.





# INTRODUCTION

## Video CD

Depending on the material on the disc (a movie, video clips, a drama series, etc.) these discs may have one or more Tracks, and tracks may have one or more indexes, as indicated on the disc case. To make access easy and convenient, your player lets you move between tracks and between indexes.



## Audio CD / MP3 CD

Audio CDs / MP3-CD contain music tracks only. You can play them in the conventional way through a stereo system using the keys on the remote control and/or main unit, or via the TV using the On Screen Display (OSD).



## GENERAL INFORMATION

### Power Sources

This unit operates on a supplied AC adaptor, car adaptor, or the built-in Ni-MH battery.

- Make sure that the input voltage of the AC adaptor is in line with the local voltage. Otherwise, the AC adaptor and unit may be damaged.
- Do not touch the AC adaptor with wet hands to prevent electric shock.
- When connecting with car power (cigarette lighter) adaptor, be sure the input voltage of the adaptor is identical with car voltage.
- Unplug the AC adaptor from the outlet when the unit is not used for long periods of time.
- Hold the plug to disconnect the AC adaptor. Do not pull the power cord.

### Safety and maintenance

- Do not disassemble the unit for laser rays are dangerous to eyes. Any service should be done by qualified service personnel.
- Unplug the AC adaptor to cut the power if liquid or objects get inside the unit.
- Take care not to drop the unit or subject it to strong shocks, which may cause malfunction.
- Important (for models with by-packed headphones): Philips guarantees compliance with the maximum sound power of its audio players as determined by relevant regulatory bodies only with the original model of provided headphones. In case this one needs replacement, we recommend that you contact your retailer to order a model identical to that of the original provided by Philips.
- Traffic safety: do not use while driving or cycling as you may cause an accident
- Do not expose to excessive heat caused by heating equipment or direct sunlight.
- This product is not waterproof: do not allow your player to be submersed in water. Water entering the player may cause major damage.
- Do not use any cleaning agents containing alcohol, ammonia, benzene, or abrasives as these may harm the player.
- The apparatus shall not be exposed to dripping or splashing. Do not place any sources of danger on the apparatus (e.g. liquid filled objects, lighted candles)
- Do not touch the lens!
- Excessive sound pressure from earphones and headphones can cause hearing loss.
- Battery shall not be exposed to excessive heat such as sunshine, fire or the like.

*Note: When the player is in use for a long period of time, the surface will be heated. This is normal.*

## Hearing Safety

### Listen at a moderate volume:

- Using headphones at a high volume can impair your hearing. This product can produce sounds in decibel ranges that may cause hearing loss for a normal person, even for exposure less than a minute. The higher decibel ranges are offered for those that may have already experienced some hearing loss.
- Sound can be deceiving. Over time your hearing "comfort level" adapts to higher volumes of sound. So after prolonged listening, what sounds "normal" can actually be loud and harmful to your hearing. To guard against this, set your volume to a safe level before your hearing adapts and leave it there.



### To establish a safe volume level:

- Set your volume control at a low setting.
- Slowly increase the sound until you can hear it comfortably and clearly, without distortion.

### Listen for reasonable periods of time:

- Prolonged exposure to sound, even at normally "safe" levels, can also cause hearing loss.
- Be sure to use your equipment reasonably and take appropriate breaks.

### Be sure to observe the following guidelines when using your headphones:

- Listen at reasonable volumes for reasonable periods of time.
- Be careful not to adjust the volume as your hearing adapts.
- Do not turn up the volume so high that you can't hear what's around you.
- You should use caution or temporarily discontinue use in potentially hazardous situations.
- Do not use headphones while operating a motorized vehicle, cycling, skateboarding, etc.; it may create a traffic hazard and is illegal in many areas.

## GENERAL INFORMATION

### Handling discs

- Do not attach paper or tape to the disc.
- Keep the disc away from direct sunlight or heat sources.
- Store the disc in a disc case after playback.
- To clean, wipe the disc outwards from the center with a soft, lint-free clean cloth.



### On handling the LCD screen

The LCD is manufactured using high precision technology. You may, however, see tiny black points and/or bright points (red, blue, green) that continuously appear on the LCD. This is a normal result of the manufacturing process and does not indicate a malfunction.

### Environmental information

We have reduced the packaging to its minimum and made it easy to separate into mono materials: cardboard, PS, PE and PET.

Your set consists of material which can be recycled if disassembled by a specialized company. Please observe the local regulations to dispose of packaging, exhausted batteries and old equipment.

### Copyright information

All other brand and product names are trademarks of their respective companies or organizations.

Unauthorized duplication of any recordings downloaded from the internet or made from CDs / VCDs / DVDs is a violation of copyright laws and international treaties.

## PREPARATIONS

### Power supply

#### Using the AC / DC adaptor

Connect the supplied adaptor to the set and the main power supply (as shown).

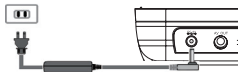

TIP

To avoid damage to the player, switch off before plugging or unplugging the AC adaptor.

#### Using the car adapter

Connect the supplied car adapter to the set and the car cigarette lighter outlet.



TIP

- To avoid damage to the player, switch off before plugging or unplugging the car adaptor.
- When connecting with car power (cigarette lighter) adaptor, be sure the input voltage of the adaptor is identical with car voltage.
- Make sure the temperature is below 35°C when the DVD player is connected to DC 16.0V in a car.

#### Powering your remote control

- 1 Open the battery compartment. Remove the protective plastic tab (first time users only).
- 2 Insert 1 x lithium 3V battery, type CR2025, then close the compartment.





#### CAUTION

- Batteries contain chemical substances, so they should be disposed of properly.
- Danger of explosion if battery is incorrectly replaced. Replace only with the same or equivalent type.
- Incorrect use of batteries can cause electrolyte leakage and will corrode the compartment or cause the batteries to burst.

# PREPARATIONS

## Connections

### Connecting headphones

Connect the headphones into the  1 or the  2 jack of your set.

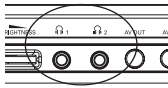

### Connecting additional equipment

- Turn off your set before connecting to any additional equipment.
- You can connect the player to a TV or an amplifier to enjoy DVDs or karaoke.

### AV OUT

Connect the desired device to this terminal directly.

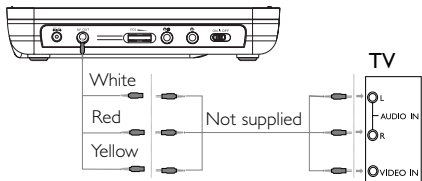

Connection (right)	Video	Audio (Left)	Audio
	Yellow	White	Red

## GENERAL EXPLANATION

### About this manual

This manual gives the basic instructions for operating this DVD player. Some DVD discs however are produced in a way that requires specific operation or allows only limited operation during playback. In these cases the player may not respond to all operating commands. When this occurs, please refer to the instructions in the disc inlay. When a "⊗" appears on the screen, the operation is not permitted by the player or the disc.

### Remote control operation

- Unless otherwise stated, all operations can be carried out with the remote control. Always point the remote control directly at the player, making sure there are no obstructions in the path of the infrared beam.
- When there are corresponding keys on the main unit, they can also be used.

### Menu navigation

- Your player has an intuitive menu navigation system to guide you through various settings and operations.
- Use the function keys to activate / disable relevant operations.
- Use ▲, ▼, ◀, ▶ to browse through menus.
- Press **OK** key to confirm your selection.

## BASIC FUNCTIONS

### Switching on for OSD language setup

English is the default language of your player's on screen display. You may choose to use English, French, German for your player's on screen display.

Region	OSD Language Options
Australia	English, French, German

- 1 Slide the **POWER** switch to **ON** to switch on the player.
- 2 Press **SETUP** for the setup menu.
- 3 Select **General Setup Page** and press **OK**.
- 4 Scroll and select **OSD Language** and press **▶** to select from OSD language options.
- 5 Select your preferred language and press **OK**.



### Loading discs and switching on

- 1 Press **OPEN** to open the disc door.
- 2 Insert your chosen disc, label side up (also when a double sided DVD disc is inserted). Make sure it is sitting properly in the correct recess.
- 3 Gently push to close the door.
- 4 Slide the **POWER** switch to **ON** to switch on the player.



TIP

A normal mechanical noise is heard during playback.



### Playing a DVD disc

After switching on, inserting the disc and closing the door, playback starts automatically. The screen shows the type of disc loaded. The disc may invite you to select an item from a menu. Use the ▲, ▼, ◀, ▶ keys to highlight your selection, and press **OK**.

*Note: Since it is usual for DVD movies to be released at different times in different regions of the world, all players have region codes and discs can have an optional region code. If you load a disc of a different region code to your player, you will see the region code notice on the screen. The disc will not play, and should be unloaded.*

### Playing an audio or video CD disc

- After switching on, inserting the disc and closing the door, playback starts automatically. The screen shows the type of disc loaded as well as information about the disc's contents.
- While playing VCD with MTV/Karaoke, press number keys(0-9) to select the track and press ►|| or **OK** to play the track.

## BASIC FUNCTIONS

### Playing an MP3 CD

The following playback features are available for MP3 CDs.  
Please refer to the corresponding sections for more information.

Volume control, skipping tracks, searching, repeat, shuffle, etc.

Use the ▲, ▼ keys to highlight your selected music folder.

Press **OK** to play.

### Playing a JPEG discs

Use the ▲, ▼, ◀, ▶ keys to highlight your selected picture folder.  
Press **OK**. The player will then automatically enter the slide show mode.

During playback, you can:

- Use the ◀, ▶ to rotate the picture.
- Use the ▲ to flip up/down.
- Use the ▼ to flip left/right.
  
- Press **DVD MENU** to go back to folder screen.
  
- Press ■ to go to group preview.
- Use the ▲, ▼, ◀, ▶ to highlight the preview picture and access the on-screen functions.
  
- Press **ZOOM** repeatedly to display the picture with different scales.
- Use the ▲, ▼, ◀, ▶ to view the zoomed picture (for picture zoomed in only).

*Note: Unless stated otherwise, all operations described are based on remote control operation.*

## GENERAL FEATURES

### Moving to another title / track / chapter

When a disc has more than one title or track, you can move to another title/track/chapter as follows:

- Press ►► briefly during play to select the next title/ track / chapter.
- Press ◀◀ briefly during play to step back to the previous title/track/chapter.
- To go directly to any title, track or chapter, enter the corresponding number using the numerical keys (0-9).



### Search

During playback, press ► repeatedly for the following forward search options:  
Press ◀ repeatedly for the following backward search options:

◀	▶
2 X backwards	2 X forward
4 X backwards	4 X forward
8 X backwards	8 X forward
16 X backwards	16 X forward
32 X backwards	32 X forward
normal speed	normal speed

Press **OK** or ►■ to resume normal playback.

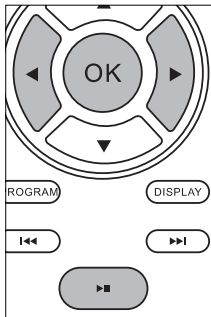

## GENERAL FEATURES

### Changing the audio output (for VCD/CD)

Press **AUDIO** repeatedly for the following audio options.

x 1	Mono left	x 2	Mono right
x 3	Stereo		



TIP

This key is used to select audio languages during DVD playback.

### ZOOM

The Zoom function allows you to enlarge the video image and to pan through the enlarged image. Press **ZOOM** repeatedly to select the following zooming options.

Zoom x 1	2X	Zoom x 2	3X
Zoom x 3	4X	Zoom x 4	normal

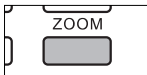

TIP

During JPEG operation, the sequence is 100%, 125%, 150%, 200%, 50%, 75% and normal.

### REPEAT

Press **REPEAT** repeatedly for the following repeat options:

	DVD actions	MP3 actions	CD actions	JPEG actions
x 1	repeats chapter	repeats one	repeats track	repeats one
x 2	repeats title	repeats folder	repeats all	repeats all
x 3	repeats all	Cancels repeat	Cancels repeat	Cancels repeat
x 4	Cancels repeat			

## GENERAL FEATURES

### TIP

The repeat function is also available for JPEG etc. The actions may vary for different media being played.

### Repeat A - B

To repeat or loop a sequence in a title:

- Press **A - B** at your chosen starting point;
  - ↻ **A** appears on the screen.
- Press **A - B** again at your chosen end point;
  - ↻ **AB** appears on the display, and the repeat sequence begins.
- To exit the sequence, press **A - B**.

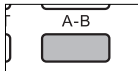

### Volume Control

- Use the rotary switch on the left side of the unit to increase or decrease playback volume.

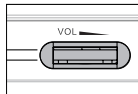

## GENERAL FEATURES

### DISPLAY

Press **DISPLAY** on the remote repeatedly for the following display options:

	DVD	CD/VCD
x 1	Title elapsed	Single elapsed
x 2	Title remained	Single remained
x 3	Chapter elapsed	Total elapsed
x 4	Chapter remained	Total remained
X5	Display off	Display off



#### TIP

During JPEG operation, pressing this button enables you to select 17 slideshow modes.

### PROGRAM

- 1 During playback, press **PROGRAM** on the remote to enter a program menu.
- 2 Use the **numerical keys 0-9** to directly input the tracks or chapters (single track number with digit "0" in front, for example "05").
- 3 Move the cursor by pressing ◀ ▶ to select START and then press **OK** to start program playback.

## SPECIAL DVD FEATURES

Checking the contents of DVD-Video discs: **DVD MENU**.

For titles and chapters, selection menus may be included on the disc. The DVD's menu feature allows you to make selections from these menus. Press the appropriate numerical key; or use the ▲, ▼, ◀, ▶ keys to highlight your selection, and press **OK**.

### Disc menu

Press **DVD MENU**. The menu may list, for example, camera angles, spoken language and subtitle options, and chapters for the title.



### Changing the language

Press **AUDIO**. If the current disc has different language options, this now appears on the screen.

Press **AUDIO** repeatedly until you have reached your desired language option.



### Subtitle

Press **SUBTITLE**. If the current disc has different subtitles options, this now appears on the screen.

Press **SUBTITLE** repeatedly until you have reached your desired subtitles option.

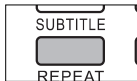

TIP

The above two features depend on whether your disc contains any language or subtitle options.

## SPECIAL DVD FEATURES

### Playing a title

- 1 Press **DVD MENU** to enter the disc title menu.
- 2 Use ◀ ▶ ▲ ▼ or **numeric keys (0-9)** to select a play option.
- 3 Press **OK** to confirm.





## SETUP OPERATIONS

To maximize your playback experience, use **SETUP** to fine tune your settings. Use the ▲, ▼, ◀, ▶ keys to highlight your selection, and press **OK**.

- 1 Press **SETUP**. A list of features is shown.
- 2 Use the ▲ ▼ keys to highlight your selection.

When the cursor highlights these settings, press **OK** to:

General Setup Page	select display and other options
Video Setup Page	select video options
Password Setup Page	select password options
Preference Page	select playback preferences

- 3 Press ◀ to abort current settings or go back to previous menu level.
- 4 Press **SETUP** to exit.

### General Setup Page

When the cursor highlights these settings, press **OK** to:

Angle Mark	select angle mark display options
OSD Language	select onscreen display language
Screen Saver	select screen saver options
Last Memory	select last playback memory options

Press ◀ to abort current settings or go back to previous menu level.

*Note: Before using the ▲, ▼ keys to select your desired angle mark, ensure the disc has been recorded with angle mark and you have enabled the angle mark option in the system menu.*

## SETUP OPERATIONS

### Video Setup Page

When the cursor highlights these settings, press **OK** to:

---

Brightness	select brightness level
------------	-------------------------

---

Contrast	select contrast level
----------	-----------------------

---

Press ◀ to abort current settings or go back to previous menu level

### Password Setup Page

When the cursor highlights these settings, press **OK** to:

---

Password	change existing password (3308 by default)
----------	--

---

Press ◀ to abort current settings or go back to previous menu level

*Note: Parental options are only selectable when password mode is deactivated.*

### Preference Page

When the cursor highlights these settings, press **OK** to:

---

Audio	select audio language options
-------	-------------------------------

---

Subtitle	select subtitle language options
----------	----------------------------------

---

Disc Menu	select disc menu language options
-----------	-----------------------------------

---

Parental	select parental options
----------	-------------------------

---

Default	restore factory settings
---------	--------------------------

---

Press ◀ to abort current settings or go back to previous menu level.

## TROUBLESHOOTING

If it appears that the DVD-Video player is faulty, first consult this checklist. It may be that something has been overlooked.

### **WARNING**

*Under no circumstances should you try to repair the set yourself as this will invalidate the guarantee.*

*If a fault occurs, first check the points listed, before taking the set for repair. If you are unable to solve a problem by following these hints, consult your dealer or service centre.*

Symptom	Remedy
<b>No power</b>	<ul style="list-style-type: none"><li>– Check if both plugs of the mains cord are properly connected.</li><li>– Check if there is power at the AC outlet by plugging in another appliance.</li><li>– Check if the built-in battery is drained.</li><li>– Check if car adaptor is connected appropriately.</li></ul>
<b>Distorted picture</b>	<ul style="list-style-type: none"><li>– Check the disc for fingerprints and clean with a soft cloth, wiping from centre to edge.</li><li>– Sometimes a small amount of picture distortion may appear. This is not a malfunction.</li></ul>
<b>Completely distorted picture / no colour in the TV screen</b>	<ul style="list-style-type: none"><li>– The PAL setting may be in the wrong status. Match your TV's setting with the player's setting.</li></ul>
<b>No sound</b>	<ul style="list-style-type: none"><li>– Check audio connections. If using a HiFi amplifier, try another sound source.</li></ul>

## TROUBLESHOOTING

### Symptom

### Remedy

---

#### Disc can't be played

- Ensure the disc label is upwards.
  - Clean the disc.
  - Check if the disc is defective by trying another disc.
- 

#### The player does not respond to the remote control

- Aim the remote control directly at the sensor on the front of the player. Avoid all obstacles that may interfere with the signal path. Inspect or replace the batteries.
- 

#### Distorted or B/W picture with DVD

- Use only discs formatted according to the TV-set used (PAL).
- 

#### Player does not respond to all operating commands during playback

- Operations are not permitted by the disc.
  - Refer to the instructions in the disc inlay.
- 

#### Player feels warm

- When the player is in use for a long period of time, the surface will be heated. This is normal.
- 

#### Display goes dimmer when AC is unplugged

- The unit is saving power to ensure longer playtime with battery. It is normal. Adjust the brightness using the rotary brightness control.
- 

***This set complies with the radio interference requirements of the European Union.***

## TECHNICAL DATA

Dimensions	210 x 178 x 39 mm 8.3 x 7.0 x 1.5 inches
Weight	1.9 kg / 4.2 pounds
Power supply	DC 9V 1.0A
Power Consumption	9W
Operating temperature range	0 - 45°C
Laser wavelength	650nm
Video system	PAL
Frequency response	20Hz ~ 20KHz $\pm$ 1dB
Signal/noise ratio	$\geq$ 80dB
Audio distortion + noise	$\leq$ -80(1KHz)
Channel separation	$\geq$ 80dB
Dynamic range	$\geq$ 80dB
Output	
Audio out (analog audio)	Output level: 2V $\pm$ 10%
Load impedance:	10K $\Omega$
Video out Output level:	1V <sub>p</sub> - p $\pm$ 20%
Load impedance:	75 $\Omega$

**PHILIPS reserves the right to make design and specification changes for product improvement without prior notice.**

**Modifications not authorized by the manufacturer may void users authority to operate this device.**

**All rights reserved.**

# AUSTRALIA - Philips Manufacturers Warranty for Australia only

**These warranty conditions are valid for the following consumer electronics products: Colour Televisions, Projection TV, Plasma & LCD TV, Video Cassette Recorders, CD Recorders & Players, DVD Players, DVD Recorders, DVD Recorders with HDD, Audio Systems, Home Theatre systems, Digital Set Top Box & Portable Audio products.**

**The benefits given to the purchaser by this warranty are in addition to all other rights and remedies which the purchaser has in respect of the product under the Trade Practices Act or other Commonwealth or State Law.**

Philips Consumer Electronics warrants its products to the purchaser as follows and subject to the stated conditions.

## **1 Year Free Repair Service - at Philips ASC**

Colour Television, Plasma Television, LCD Television, Projection Television, DVDR/VCR Combo, DVD Recorders with Hard Drive, LCD Projectors, Wireless Audio Systems, Audio Systems, Home Theatre Systems & Digital Set-Top-Box.

## **1 Year free Replacement – at your Retailer**

Portable Audio, MP3 Infotainment products, Video Cassette recorders, DVD Player; DVD/VCR Combo Player; DVD Recorder without HDD & Portable DVD/LCD players.

## **Conditions of Repair Warranty**

1. All claims for warranty service should be made to your nearest Philips Authorised Service Centre or the Philips Technology Care Centre. Reasonable evidence of date of purchase must be provided.
2. This warranty extends only to defects in material or workmanship occurring under normal use of the product when operated in accordance with the instructions.
3. If a replacement product is supplied under the repair policy it is warranted, under this warranty, for the remainder of the warranty of the original purchased product only.
4. Home service is provided only within the normal service area of one of our recommended Authorised Service Centres (ASC). It will be provided for television receivers only with a screen size of 67cms or above (product includes CRT, LCD TV, PTV, and Plasma TV). Televisions with screen size less than 67cms and all other products types are to be taken or sent by the consumer to the workshop of your nearest Authorised Service Centre, at the Consumer's expense.
5. This Manufacturers Warranty is limited to 3 months for the above listed Consumer Electronics products if used in commercial applications.
6. Philips may, at its discretion choose to replace rather than repair any product covered by this warranty.
7. Product accessories are covered by the same warranty period. Please contact the Philips Technology

Care Centre for free replacement of faulty accessories.

8. This Manufacturers Warranty is neither transferable nor valid in countries other than Australia.

## **This warranty does not cover:**

- a) Mileage or travel outside the normal service area covered by selected Authorised Service Centre.
- b) Service costs arising from failure to correctly adjust the controls of the product or to observe the instructions, or inspections that reveal that the product is in normal working order.
- c) Product failures caused by misuse, neglect, accidental breakage, transit damage, inexpert repairs or modification by un-authorized persons, external fires, lightning strikes, floods, vermin infestation or liquid spillage.
- d) Cleaning of video or audio heads.
- e) Inadequate receiving antennae.
- f) Replacement of worn or used batteries or other consumables.
- g) Consumer products used in commercial applications (This warranty is limited to 3 months only).
- h) Second hand products.

**The conditions contained in this warranty card replace and override the provision of the Philips World-Wide Guarantee for products purchased in Australia and used in Australia.**

Service is provided through more than 100 accredited Authorised Service Centres throughout Australia. For direct contact with the nearest recommended Authorised Service Centre in capital & regional cities/towns

## **Authorised Service Centre Network**

**1300 361 392**

Customer support is provided in Australia by our trained call centre staff. For assistance with product features and specifications, please call

## **Technology Care Centre**

**1300 363 391**

**Please record the following information for your records and keep in a safe place. We recommend retaining your purchase receipt to assist with any warranty claim.**

Model number:.....

Serial number:.....

Date of purchase:.....

Retailer:.....

## **Philips Consumer Electronics**

a division of **Philips Electronics Australia Limited**  
ABN 24 008 445 743,  
Level 1, 65 Epping Road NORTH RYDE NSW 2113.

Meet Philips at the Internet  
<http://www.philips.com>

**CLASS 1  
LASER PRODUCT**

PET714  
PET718



Printed in China

WK748