

Registre seu produto e obtenha suporte em
www.philips.com/welcome

SoundBar

Série 5000



Instruções básicas de uso

PHILIPS



PT Antes de usar o produto, leia todas as informações de segurança em anexo

ES Antes de usar el producto, consulte la información de seguridad que se encuentra adjunta

EN Before using your product, read all accompanying safety information



PT Conteúdo da embalagem

ES Contenido de la caja

EN What's in the box

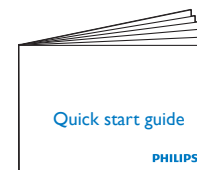
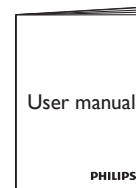
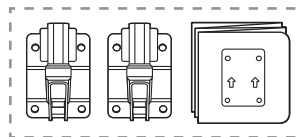
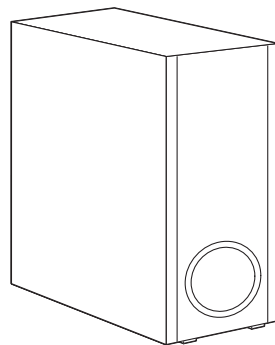
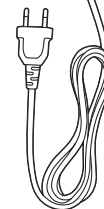
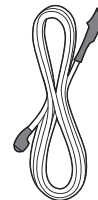
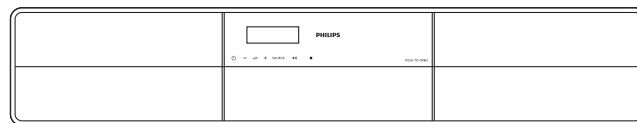

1

PT Posicionar o SoundBar

ES Posicione el sistema SoundBar

EN Position the SoundBar

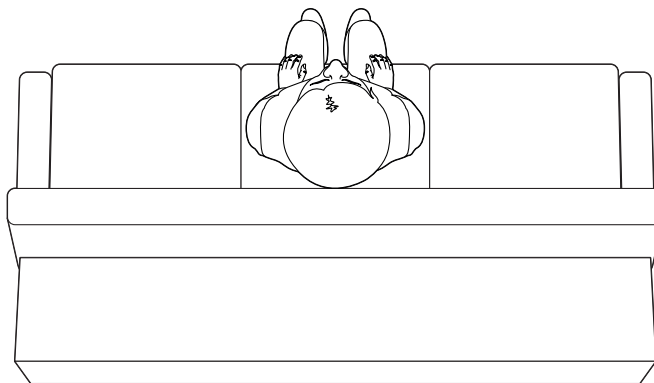
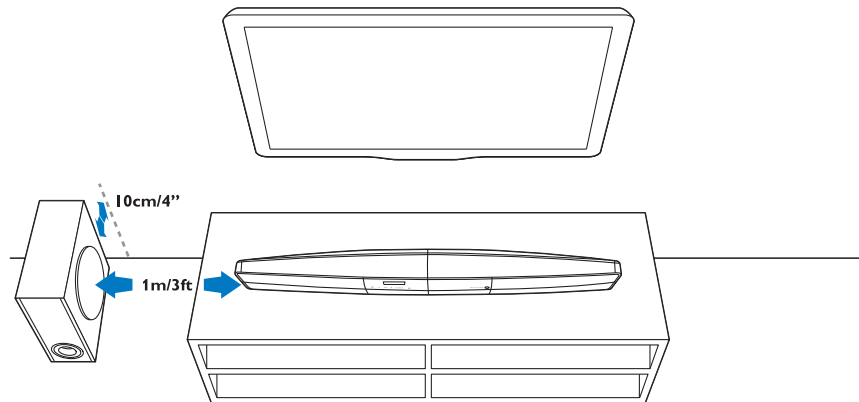

2

- PT** Conectar o SoundBar
- ES** Conecte el sistema SoundBar
- EN** Connect the SoundBar

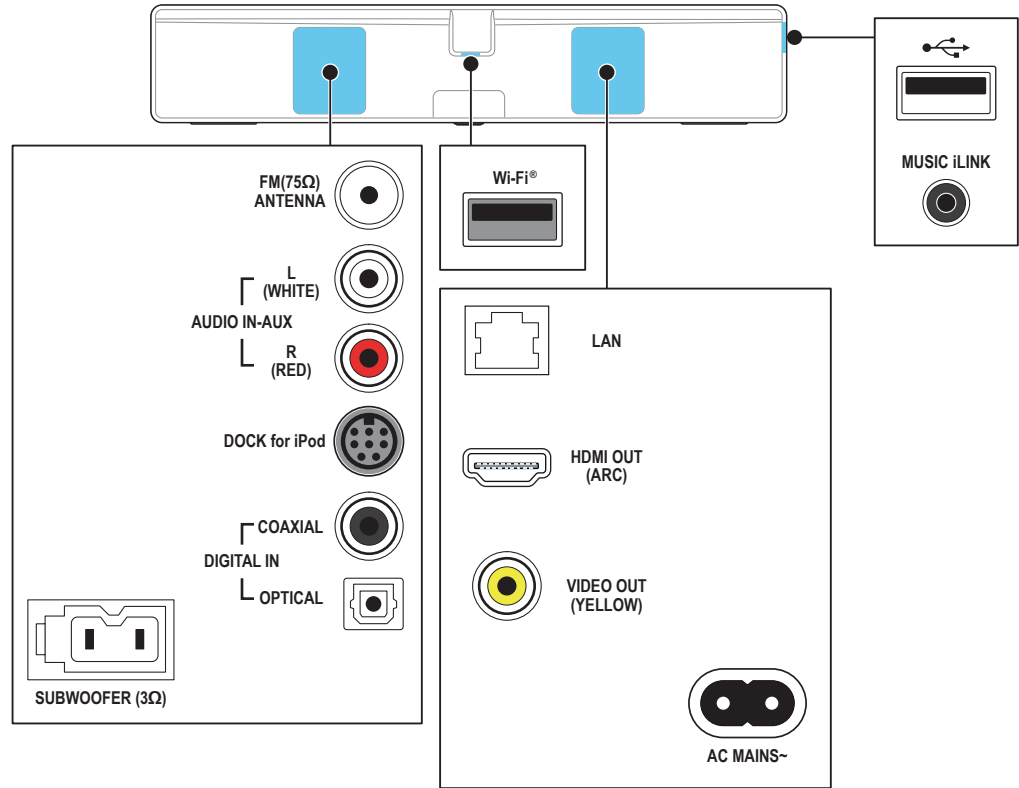

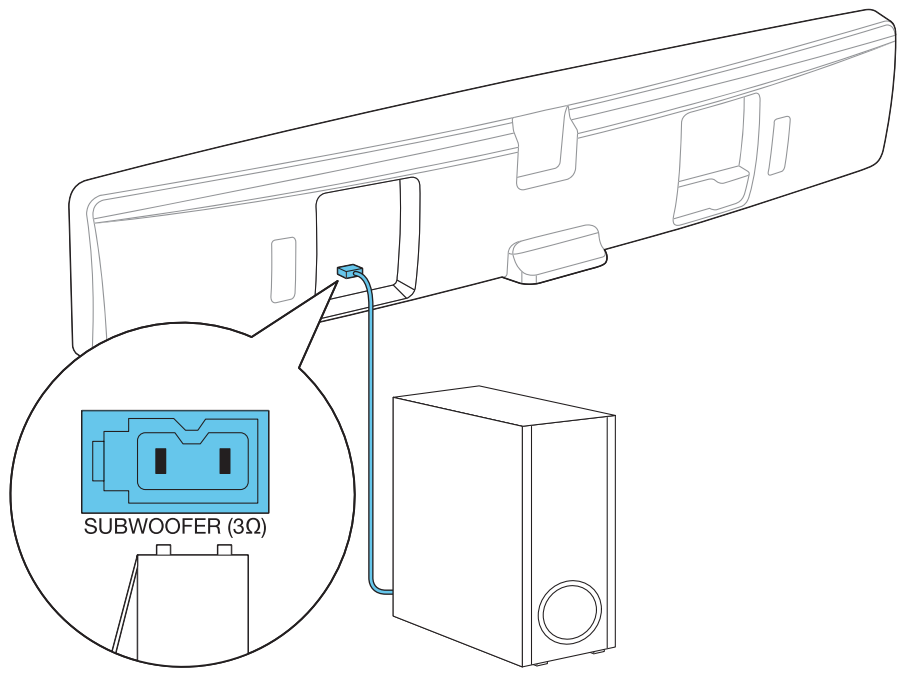

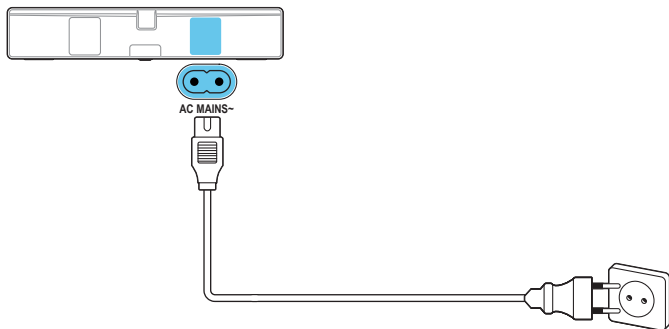
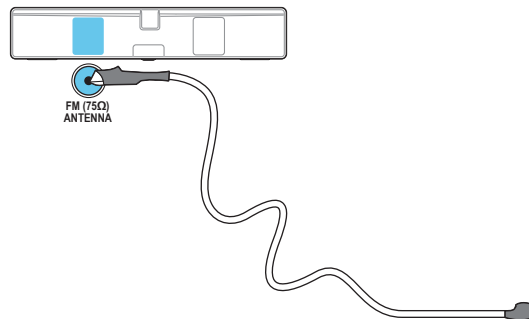
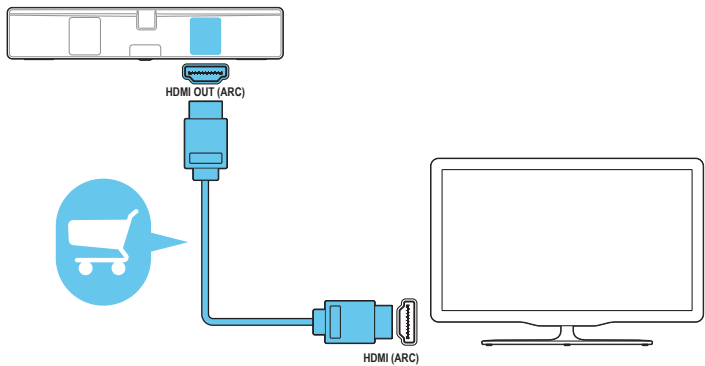

3

PT Ligar a SoundBar

ES Encienda el sistema SoundBar

EN Switch on the SoundBar

1

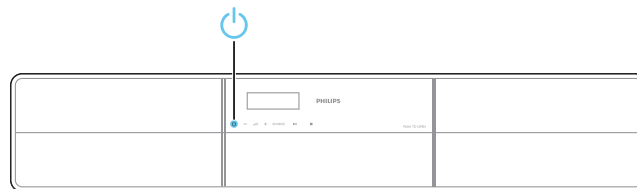

2

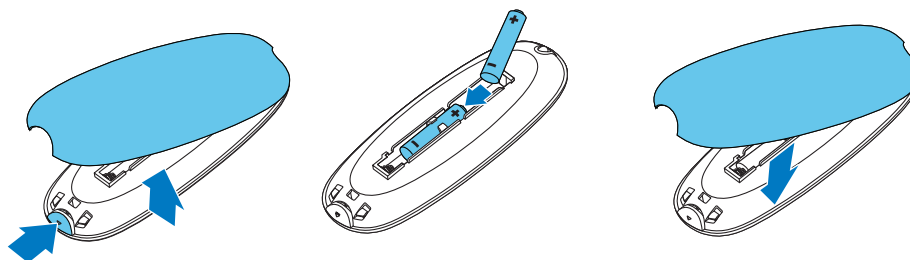



PT Selecione seu idioma

ES Seleccionar el idioma

EN Select your language

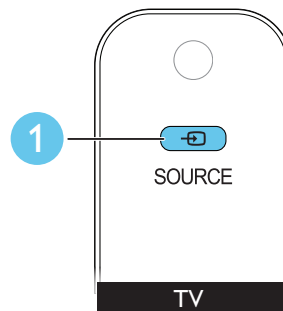
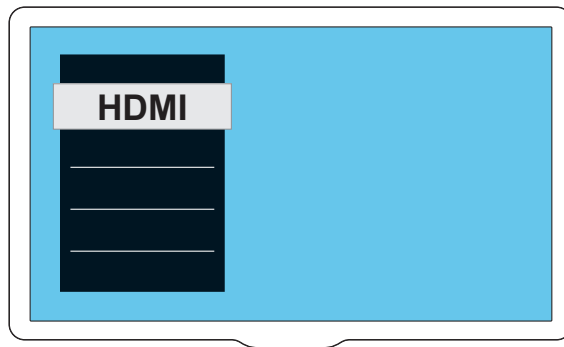

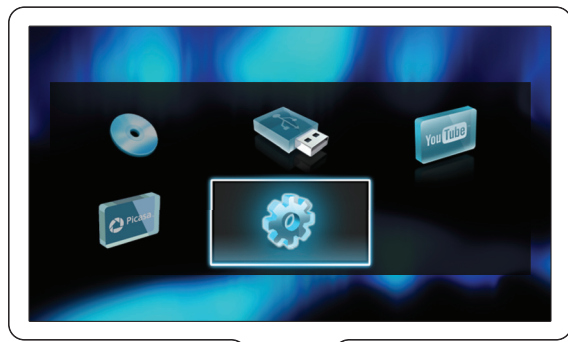

Video	Menu Language	Auto (ENG)
Audio	Audio	English
Network	Subtitle	Español
EasyLink	Disc Menu	Português
Preference	Parental Control	
Advanced	Screen Saver	
	Change Password	
	Display Panel	

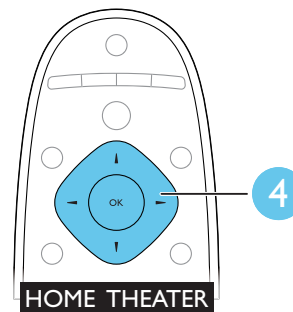
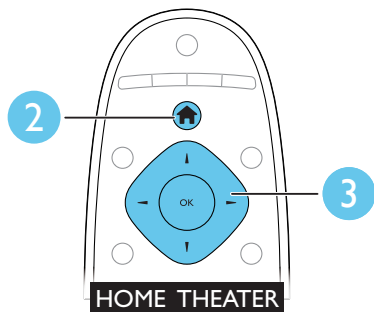

5

PT Use seu SoundBar

ES Uso del sistema SoundBar

EN Use your SoundBar

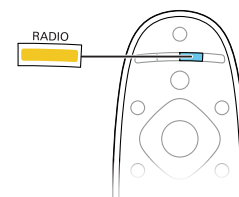
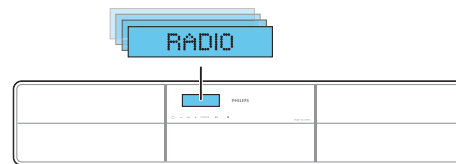
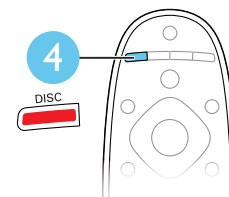
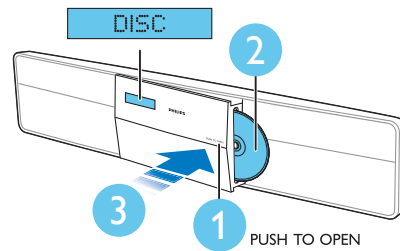

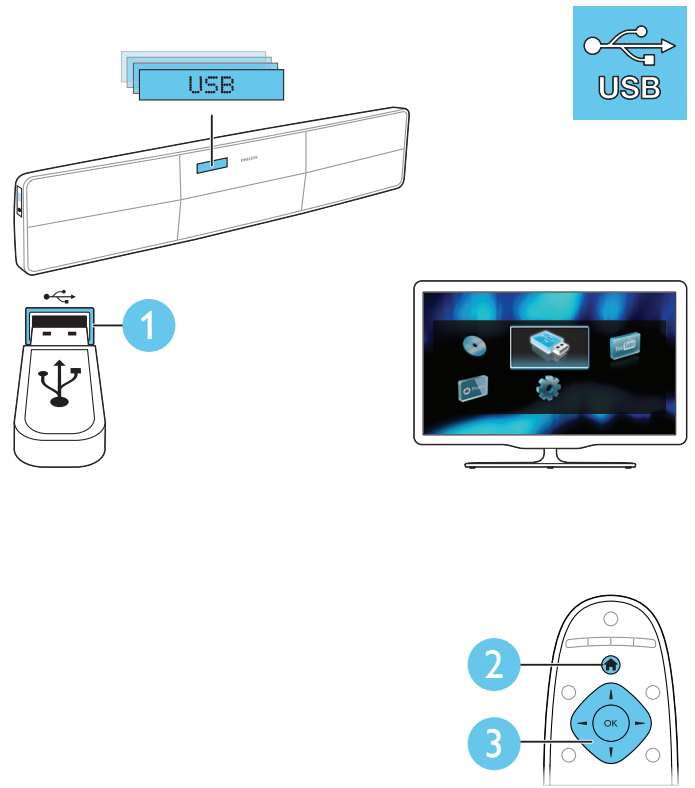
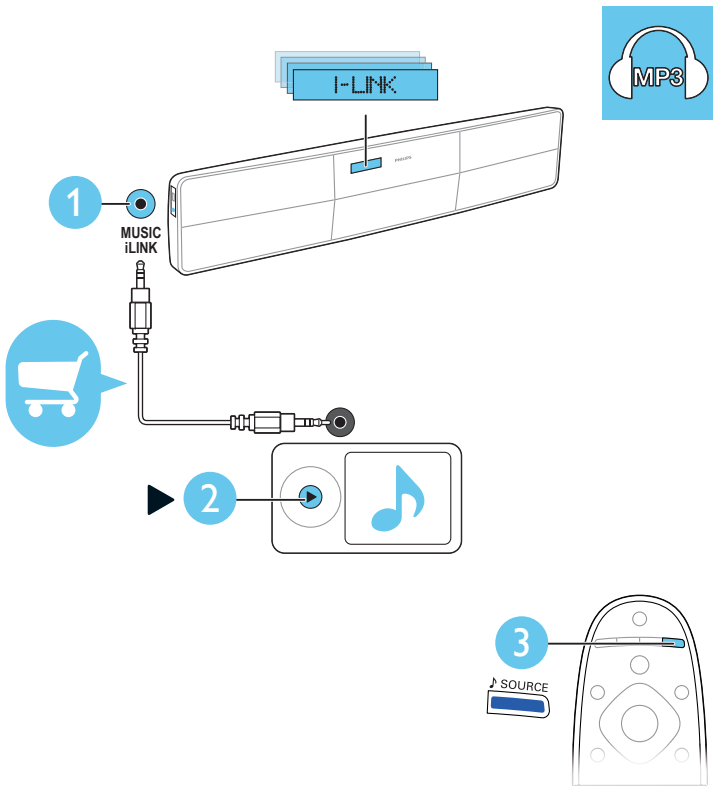

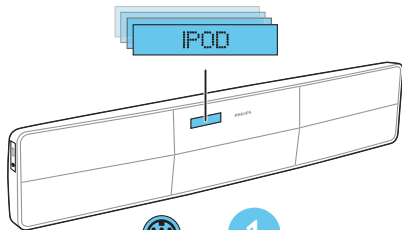

1
DOCK for iPod

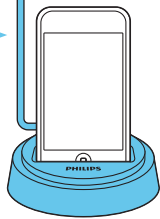

2

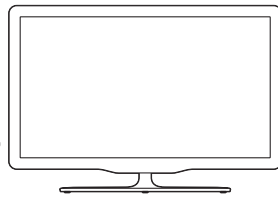
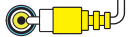

3

DOCK
for iPod

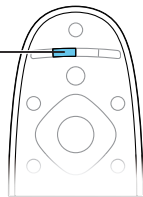



- PT** Dependendo do tipo de parede, você tem que usar os parafusos de comprimento e diâmetro adequados para a instalação do suporte na parede
- ES** Dependiendo del tipo de pared, verifique que usa tornillos del tamaño y diámetro apropiados para montar el soporte en la pared
- EN** Depending on the type of wall, make sure that you use screws of suitable length and diameter to wall mount the bracket

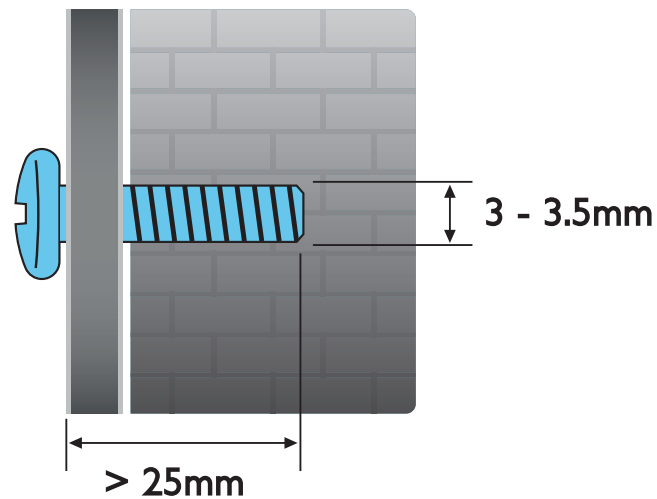

PT Faça o download de atualizações do software e do manual do usuário em www.philips.com/support

ES Descargue actualizaciones de software y un manual del usuario para imprimir en www.philips.com/support

EN Download software updates and a printable user manual from www.philips.com/support.



www.philips.com/support



Non-contractual images. / Images non contractuelles. / Außervertragliche Bilder.

All registered and unregistered trademarks are property of their respective owners.

Specifications are subject to change without notice

Trademarks are the property of Koninklijke Philips Electronics N.V. or their respective owners
2011 © Koninklijke Philips Electronics N.V. All rights reserved

www.philips.com

sgsn_1147/78_v1

Evite o uso prolongado do aparelho com volume superior a 85 decibéis, pois isto poderá prejudicar a sua audição.

Potência total de saída de 300W RMS, 10% THD



Be responsible
Respect copyrights

