

Always there to help you

Register your product and get support at
www.philips.com/welcome



NTRX510



User manual

PHILIPS

Contents

1 Important	2
Safety	2
Notice	3

2 Your Mini Hi-Fi System	4
Introduction	4
What's in the box	4
Overview of the main unit	5
Overview of the remote control	6

3 Connect	8
Connect FM antenna	8
Connect AM antenna	8
Connect power	8

4 Get started	10
Prepare the remote control	10
Turn on	10

5 Play from a USB	11
Play from a USB A device	11
Play from a USB B device	11
Play options	12

6 Play audio through Bluetooth	13
---------------------------------------	-----------

7 Listen to an external device	15
Listen to an MP3 player	15
Listen to other devices	15

8 Listen to radio	16
Tune to a radio station	16
Program radio stations manually	16
Program radio stations automatically	16
Select a preset radio station	16
Change AM tuning grid	16

9 Adjust volume level and sound effect	17
Adjust volume level	17
Mute sound	17
Apply AUTO DJ effect	17
Apply DJ effects manually	17
Select a preset sound effect	17
Enhance bass	18
Apply NX Bass	18
Adjust equalizer settings	18

10 Other features	19
Mix sound	19
Karaoke	19
USB record	19

11 Product information	20
Specifications	20
USB playability information	20

12 Troubleshooting	21
---------------------------	-----------

1 Important

Safety



This 'bolt of lightning' indicates uninsulated material within your unit may cause an electrical shock. For the safety of everyone in your household, please do not remove product covering.

The 'exclamation point' calls attention to features for which you should read the enclosed literature closely to prevent operating and maintenance problems.

WARNING: To reduce the risk of fire or electric shock, this apparatus should not be exposed to rain or moisture and objects filled with liquids, such as vases, should not be placed on this apparatus.

CAUTION: To prevent electric shock, match wide blade of plug to wide slot, fully insert.

Important Safety Instructions

- ① Read these instructions.
- ② Keep these instructions.
- ③ Heed all warnings.
- ④ Follow all instructions.
- ⑤ Do not use this apparatus near water.
- ⑥ Clean only with dry cloth.
- ⑦ Install in accordance with the manufacturer's instructions.
- ⑧ Do not install near any heat sources such as radiators, heat registers, stoves, or other apparatus (including amplifiers) that produce heat.
- ⑨ Protect the power cord from being walked on or pinched, particularly at plugs, convenience receptacles, and the point where they exit from the apparatus.
- ⑩ Only use attachments/accessories specified by the manufacturer.
- ⑪ Use only with the cart, stand, tripod, bracket, or table specified by the manufacturer or sold with the apparatus. When a cart is used, use caution when moving the cart/apparatus combination to avoid injury from tip-over.
- ⑫ Unplug this apparatus during lightning storms or when unused for long periods of time.
- ⑬ Refer all servicing to qualified service personnel. Servicing is required when the apparatus has been damaged in any way, such as power-supply cord or plug is damaged, liquid has been spilled or objects have fallen into the apparatus, the apparatus has been exposed to rain or moisture, does not operate normally, or has been dropped.
- ⑭ **Battery usage CAUTION** – To prevent battery leakage which may result in bodily injury, property damage, or damage to the unit:
 - Install all batteries correctly, + and - as marked on the unit.
 - Do not mix batteries (old and new or carbon and alkaline, etc.).
 - Remove batteries when the unit is not used for a long time.



- Batteries (battery pack or batteries installed) shall not be exposed to excessive heat such as sunshine, fire or the like.

- 15) Apparatus shall not be exposed to dripping or splashing.
- 16) Do not place any sources of danger on the apparatus (e.g. liquid filled objects, lighted candles).
- 17) Where the MAINS plug or an appliance coupler is used as the disconnect device, the disconnect device shall remain readily operable.

Warning

- Never remove the casing of this apparatus.
- Never lubricate any part of this apparatus.
- Never place this apparatus on other electrical equipment.
- Keep this apparatus away from direct sunlight, naked flames or heat.
- Ensure that you always have easy access to the power cord, plug or adaptor to disconnect the apparatus from the power.

Notice

Any changes or modifications made to this device that are not expressly approved by Philips Consumer Lifestyle may void the user's authority to operate the equipment. Your product is designed and manufactured with high quality materials and components, which can be recycled and reused. Never dispose of your product with other household waste. Please inform yourself about the local rules on the separate collection of electrical and electronic products and batteries. The correct disposal of these products helps prevent potentially negative consequences on the environment and human health. Your product contains batteries, which cannot be disposed of with normal household waste.

Please inform yourself about the local rules on separate collection of batteries. The correct disposal of batteries helps prevent potentially negative consequences on the environment and human health.

Please visit www.recycle.philips.com for additional information on a recycling center in your area.



The making of unauthorized copies of copy-protected material, including computer programs, files, broadcasts and sound recordings, may be an infringement of copyrights and constitute a criminal offence. This equipment should not be used for such purposes.

Environmental information

All unnecessary packaging has been omitted. We have tried to make the packaging easy to separate into three materials: cardboard (box), polystyrene foam (buffer) and polyethylene (bags, protective foam sheet.) Your system consists of materials which can be recycled and reused if disassembled by a specialized company. Please observe the local regulations regarding the disposal of packaging materials, exhausted batteries and old equipment.

This apparatus includes this label:



Note

- The type plate is located on the back of the unit.

2 Your Mini Hi-Fi System

Congratulations on your purchase, and welcome to Philips! To fully benefit from the support that Philips offers, register your product at www.Philips.com/welcome.

Introduction

With this unit, you can enjoy audio from USB devices, Bluetooth devices or external devices. You can also listen to radio stations through it. To enrich sound, this unit offers you these sound effects:

- Digital Sound Control (DSC)
- Dynamic Bass Boost (DBB)
- DJ effects
- NX Bass Enhancement

The unit supports the following media formats:



What's in the box

Check and identify the contents of your package:

- Main unit x 1
- Remote control with 2 AAA batteries
- FM wire antenna x 1
- AM loop antenna x 1
- Short user manual

Overview of the main unit

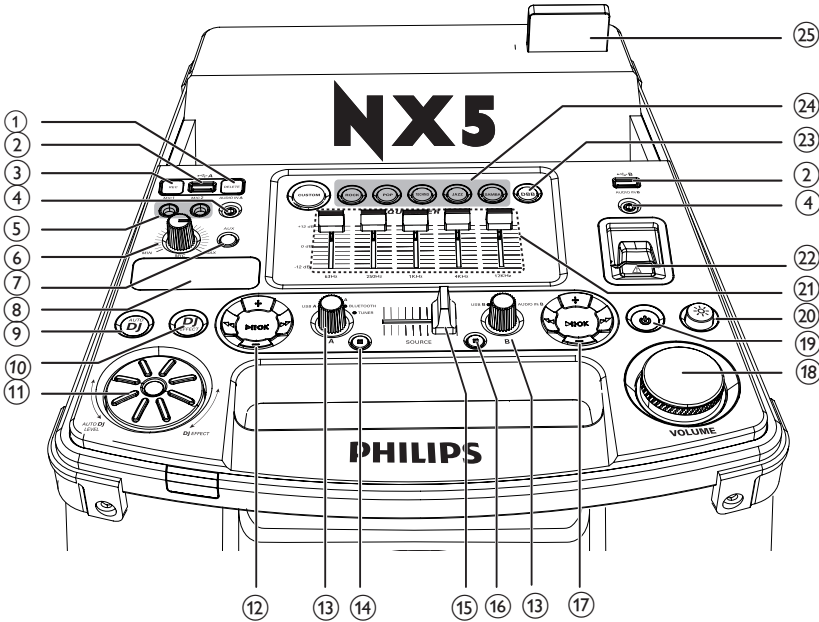

- | | |
|--|--|
| <p>① DELETE</p> <ul style="list-style-type: none"> In USB A mode, delete audio files stored on a USB device. <p>② A/B</p> <ul style="list-style-type: none"> Jacks for USB mass storage devices. <p>③ REC</p> <ul style="list-style-type: none"> Record to a USB. <p>④ AUDIO IN A/B</p> <ul style="list-style-type: none"> Audio input jack (3.5mm) for an external audio device. <p>⑤ MIC 1/2 (Microphone ports)</p> <ul style="list-style-type: none"> Jack for a microphone. <p>⑥ MIC volume dial</p> <ul style="list-style-type: none"> Rotate to adjust microphone volume. <p>⑦ AUX</p> <ul style="list-style-type: none"> Select an audio source from PC, DVD, TV or GAME. | <p>⑧ Display panel</p> <ul style="list-style-type: none"> Show status. <p>⑨ AUTO DJ</p> <ul style="list-style-type: none"> In USB A mode, apply Auto DJ effect automatically. <p>⑩ DJ EFFECT</p> <ul style="list-style-type: none"> In USB A/Bluetooth/Tuner/Audio in A mode, apply DJ effects manually. <p>⑪ DJ EFFECT dial</p> <ul style="list-style-type: none"> Increase/decrease DJ effect and AUTO DJ levels. <p>⑫ Control play panel (left)</p> <ul style="list-style-type: none"> Control play for Source A modes (including USB A, Bluetooth, Tuner and Audio in A modes). <p>⑬ Source selection dials</p> <ul style="list-style-type: none"> Select a source. |
|--|--|

- 14 ■ (Left)
- In USB A mode, stop playing.
 - In USB A mode, erase programs.
 - Exit the process of recording.
 - In Tuner mode, switch between FM and AM bands.

- 15 CROSS FADER ASSIGN
- Adjust the left/right channel balance during playback.

- 16 ■ (Right)
- In USB B mode, stop playing.

- 17 Control play panel (right)
- Control play for **Source B** modes (including USB B and Audio in B modes).

- 18 Volume dial
- Rotate to increase/decrease volume.

- 19 
- Turn on the unit or switch to standby mode.

- 20 
- Turn on or off the lighting effect.

- 21 Custom Equalizer
- Move the slider bars to adjust the equalizer settings for each of the 5 frequency ranges.

- 22 NX Bass button
- Turn on NX Bass effect.



- 23 DBB
- Turn on/off dynamic bass enhancement.

- 24 Sound effects keys
- Select a preset sound equalizer setting.

- 25 Bluetooth indicator

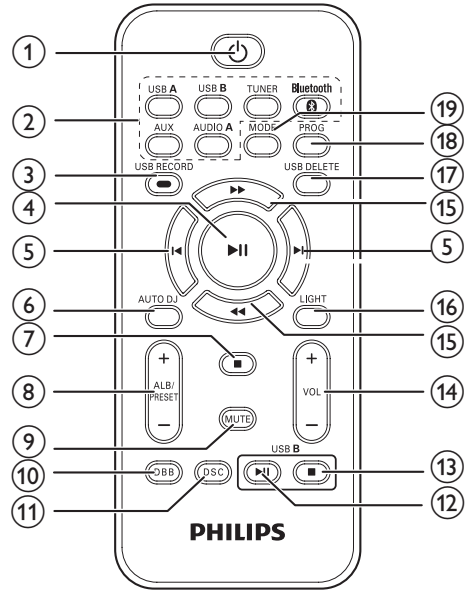
Overview of the remote control



- 1 
- Turn on the unit or switch to standby mode.
- 2 **Source selection keys**
- Select a source.
- 3 **USB RECORD**
- Record to a USB device.
- 4 
- In USB A/Bluetooth mode, start or pause play.
- 5 
- In USB A/Bluetooth mode, skip to the previous/next track.
- 6 **AUTO DJ**
- In USB A mode, apply Auto DJ effect automatically.
- 7 ■
- In USB A mode, stop playing.
 - In USB A mode, erase programs.

- Exit the process of recording.
- ⑧ **ALB/PRESET+/-**
 - Skip to the previous/next album.
 - Select a preset radio station.
 - ⑨ **MUTE**
 - Mute/unmute volume.
 - ⑩ **DBB**
 - Turn on or off dynamic bass enhancement.
 - ⑪ **DSC**
 - Select a preset sound equalizer setting.
 - ⑫ **USB B ►||**
 - In USB B mode, start or pause play.
 - ⑬ **USB B ■**
 - In USB B mode, stop playing.
 - ⑭ **VOL +/-**
 - Adjust volume.
 - ⑮ **◀◀ / ▶▶**
 - Adjust radio frequency.
 - In USB A mode, search with in a track.
 - ⑯ **LIGHT**
 - Turn on or off the speaker lighting effect.
 - ⑰ **USB DELETE**
 - In USB A mode, delete audio files stored on a USB storage device.
 - ⑱ **PROG**
 - Program tracks.
 - Program radio stations.
 - ⑲ **MODE**
 - In USB A mode, select repeat play or random play.

3 Connect

Connect FM antenna

Connect the supplied FM antenna to the **FM** jack on the back of the main unit.

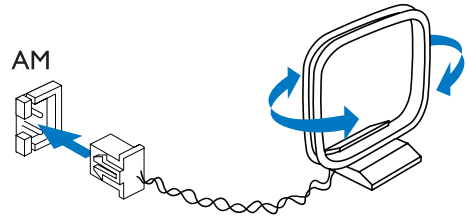
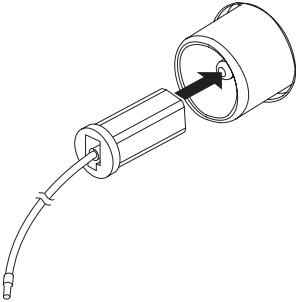

Connect AM antenna

1 Assemble the AM loop antenna.

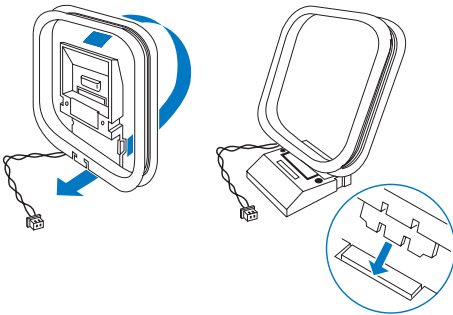

2 Connect the AM loop antenna to the **AM** jack on the back of the main unit. Adjust the position of the antenna for optimal reception.

Connect power

- 1 If your power supply voltage is 110V-127V, adjust the voltage selector (locate on the back panel of the unit) to 110V-127V.
- 2 Connect the AC power plug to the power outlet.

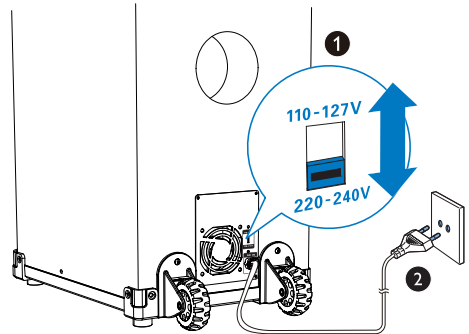

! Caution

- Risk of product damage! Make sure that the power supply voltage corresponds to the voltage set on the voltage selector on the bottom of the unit.
- Before connecting to the AC power, make sure that you have completed all other connections.



Tip

- When you are not using or are transporting the unit, to keep the power cord organized and above the ground, fix the power cable with the cable tie on the back panel of the main unit.

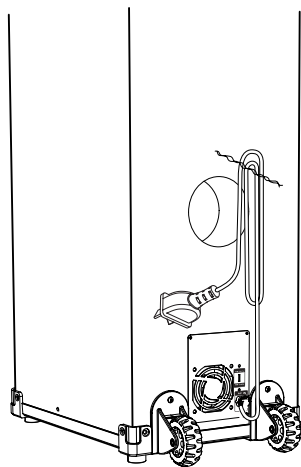

4 Get started



Caution

- Use of controls or adjustments or performance of procedures other than herein may result in hazardous radiation exposure or other unsafe operation.

Always follow the instructions in this chapter in sequence.

If you contact Philips, you will be asked for the model and serial number of this apparatus. The model number and serial number are on the back of the apparatus. Write the numbers here:

Model No. _____

Serial No. _____

Prepare the remote control



Note

- Risk of explosion! Keep batteries away from heat, sunshine or fire. Never discard batteries in fire.
- Danger of explosion if battery is incorrectly replaced. Replace only with the same or equivalent type.

To replace the remote control battery:

- 1 Open the battery compartment.
- 2 Insert two AAA batteries with correct polarity (+/-) as indicated.
- 3 Close the battery compartment.

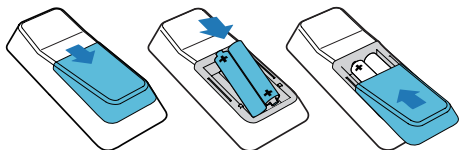

Note

- If you are not going to use the remote control for a long time, remove the batteries.
- Do not use old and new or different types of batteries in combination.
- Batteries contain chemical substances, so they should be disposed of properly.

Turn on

Press \odot .

- ↳ The unit switches to the last selected source.

Switch to standby

Press \odot to switch the unit to standby mode.

- ↳ The backlight on the display panel turns off.

5 Play from a USB

Play from a USB A device

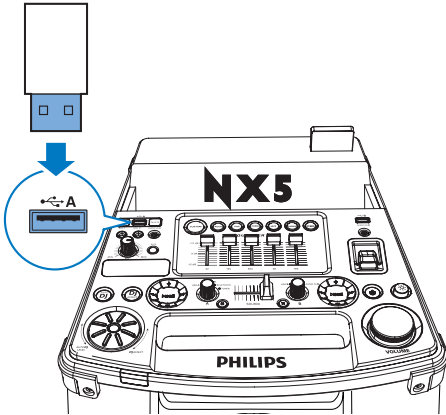

Note

- Ensure that the USB device contains playable audio contents for supported formats.

- 1 Insert the USB plug of the device into the **USB A** socket.
- 2 Press **USB A** to select the USB A source.
- 3 Slide the **CROSS FADER ASSIGN** to its left-most end.
- 4 Press **ALB/PRESET+/-** to select an album.
- 5 Press **◀/▶** to select an audio file.
- 6 Press **▶||** to start play.
 - To pause/resume play, press **▶||**.
 - To stop play, press **■**.
 - To search within an audio file, press and hold **◀/▶**, then release to resume normal play.

Delete from a USB device

- 1 During play from a USB device, press **◀/▶** to select an audio file.
 - To delete an audio folder; in the stop position, press **ALB/PRESET+/-** to select an audio folder.
- 2 Press **USB DELETE**.
 - ↳ A confirmation message is displayed.
- 3 While the message is displayed, press **USB DELETE** again to confirm.
 - To cancel, press **■**.

Note

- The function is not available in USB B mode.

Play from a USB B device

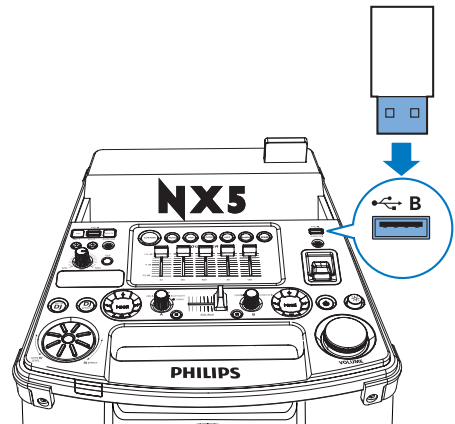

- 1 Insert the USB plug of the device into the **USB B** socket.
- 2 Press **USB B** to select the USB B source.
- 3 Slide the **CROSS FADER ASSIGN** to its right-most end.
- 4 Use the control play panel (right) on the top of the main unit for play:
 - To start play, press **▶||**.
 - Press **+/-** to select an album.

- Press ◀◀/▶▶ to select an audio file.
- To pause/resume play, press ▶⏸.
- To stop play, press ■ (right) on the main unit.
- To search within an audio file, press and hold ◀◀/▶▶, then release to resume normal play.

- 6 Press ▶⏸ to play the programmed track.
- To erase the program, press ■ for two times.

Note

- The function is not available in USB B mode.

Play options

Repeat and random play

- 1 Press **MODE** repeatedly to select:
 - **REP-1**: the current track is played repeatedly.
 - **REP-ALL**: all tracks are played repeatedly.
 - **SHUFFLE**: all tracks are played randomly.
- 2 To return to normal play, press **MODE** repeatedly until play mode is no longer displayed.

Note

- Shuffle play cannot be selected when you play programmed tracks.
- This function is only available in USB A mode.

Program tracks

You can program a maximum of 40 tracks.

- 1 In USB A mode, press ■ to stop playing.
- 2 Press **PROG** to activate program mode.
 - ↳ A position number flashes on the screen.
- 3 For MP3 tracks, press **ALB/PRESET+/-** to select an album.
- 4 Press ◀/▶ to select a track number; then press **PROG** to confirm.
- 5 Repeat steps 2 to 4 to select and store all tracks to program.

6 Play audio through Bluetooth

The unit uses Bluetooth wireless technology to stream music from your Bluetooth device to the system.

Note

- Before you connect a Bluetooth device to this unit, familiarize yourself with the Bluetooth capabilities of the device.
- The effective operation range between the unit and the paired phone is approximately 10 meters (30 feet).
- Any obstacle between the unit and the phone can reduce the operational range.
- Keep this unit away from other electronic devices that may cause interference.

- 1 Press **Bluetooth** to turn on Bluetooth function of the unit.
↳ The Bluetooth indicator blinks.
- 2 On your Bluetooth, go to **[Settings]** (Settings)> **[Wireless and networks]** (Wireless and networks)> **[Bluetooth settings]** (Bluetooth settings).
- 3 Tap **[Bluetooth]** (Bluetooth) to turn on Bluetooth function of your device.
- 4 Tap **[Search for devices]** (Search for devices).
↳ A Bluetooth pairing request appears.

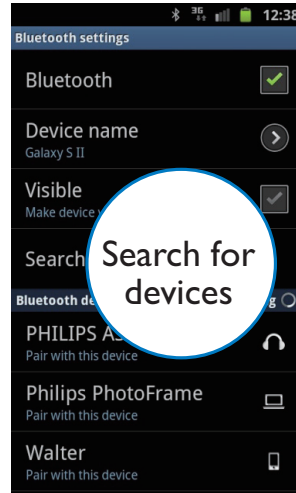

- 5 Tap **[Accept]** (Accept) to start pairing your device with the unit.

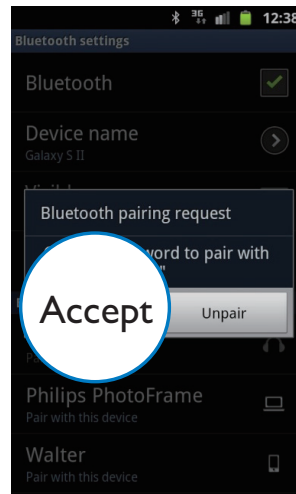

- ↳ **[PHILIPS NTRX510]** (Philips NTRX510) is displayed.
- ↳ If connected successfully, a different Bluetooth icon can be found on the top of the screen.

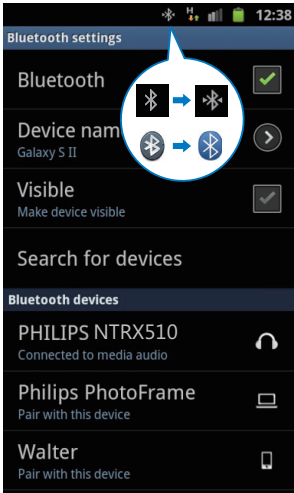

↳ After Bluetooth connection, you can enjoy audio on your phone through the unit.

Tip

- Different devices may have different way to enable Bluetooth function.

7 Listen to an external device

You can listen to an external audio device through the speakers of this unit.

Listen to an MP3 player

- 1 Press **AUDIO A** to select the MP3 link source.
- 2 Connect a 3.5mm audio link cable(not supplied) to:
 - the **AUDIO IN A** jack (3.5mm) on the unit.
 - the headphone jack on the MP3 player.
- 3 Start to play the device (refer to the device user manual).



Tip

- If the MP3 player is connected to the **AUDIO IN B** jack, use the Source selection dial on the main unit to select the Audio In B source.

Listen to other devices

You can connect a PC or other audio devices.

- 1 Press **AUX** repeatedly to select from DVD, PC, TV or GAME source.
- 2 Connect the audio cables (white/red, not supplied) to:
 - the **AUX** jacks (white/red) on the back of the main unit.
 - the headphone jack on the DVD, PC, or **AUDIO OUT** jacks on an external device.
- 3 Start to play the device (refer to the device user manual).

8 Listen to radio

Tune to a radio station

- 1 Press **TUNER** on the remote control, or **■** (Left) on the main unit repeatedly to select FM or AM.
- 2 Press and hold **◀▶**.
 - ↳ [SEARCH] (search) is displayed.
 - ↳ The radio automatically tunes to a station with a strong signal.
- 3 Repeat step 2 to tune to more stations.
 - To tune to a station with a poor signal, press **◀▶** repeatedly until you find optimal reception.

Program radio stations manually

You can program a maximum of 30 FM and 10 AM preset radio stations.

- 1 Tune to a radio station.
- 2 Press **PROG** to activate program mode.
 - ↳ A position number is displayed.
- 3 Press **ALB/PRESET+/-** to allocate a number to this radio station, then press **PROG** to confirm selection.
- 4 Repeat the above steps to program other stations.

Tip

- To overwrite a programmed station, store another station in its place.

Program radio stations automatically

In the tuner mode, press and hold **PROG** for more than 2 seconds to activate automatic program mode.

- ↳ [AUTO] (auto) is displayed.
- ↳ The unit automatically stores radio stations with sufficient signal strength.
- ↳ After all available radio stations are stored, the first stored radio station is broadcast automatically.

Select a preset radio station

In tuner mode, press **ALB/PRESET+/-** to select a preset number:

Tip

- Position the antenna as far as possible from TV, VCR or other radiation source.
- For optimal reception, fully extend and adjust the position of the antenna.

Change AM tuning grid

In some countries, the AM radio frequency step between adjacent channels is 10 kHz (9 kHz in some areas).

- 1 Select the tuner source.
- 2 Press and hold **■** for more than 5 seconds.
 - ↳ The frequency step is changed to 9 kHz or 10 kHz.
 - ↳ All preset stations are erased and re-programmed in AM mode.

9 Adjust volume level and sound effect

Adjust volume level

- 1 During play, press **VOL +/-** to increase/decrease the volume level.

Mute sound

During play, press **MUTE** to mute/unmute sound.

Apply AUTO DJ effect

The AUTO DJ function adds various sound and playback effects to your music automatically.

Effects	Description
Auto effect	Add different sound effects to the music automatically.
Cross fade	Fade one piece of music out while fading another piece of music in at the same time.
Back spin	Rewind the music to a previous point.
Loop	Repeat playing a section of the music.
Beat box	Add beat box effects to the music.
Voice sampling	Add a sound during playback.

- To apply AUTO DJ effects, press **AUTO DJ** repeatedly to select from:
 - [METAL] (Metal)
 - [PARTY] (party)
- To turn off the AUTO DJ effects, press **AUTO DJ** repeatedly to select [AUTO DJ OFF] (AUTO DJ off).

- To adjust the occurrence frequency and sound level of the added effects, rotate the **DJ EFFECT** dial.

Note

- Such effects are added by the application automatically and randomly.
- The function is only available in USB A mode.

Apply DJ effects manually

You can also add preset DJ effects by yourself.

- Press **DJ EFFECT** repeatedly to select from the following effects:
 - [SCRATCH] (scratch)
 - [REVERB] (reverb)
 - [BEAT BOX] (beat box)
 - [YEAH] (yeah)
- To turn off the DJ effects, press **DJ EFFECT** repeatedly to select [OFF] (off).
- To adjust the sound level of the added effects, rotate the **DJ EFFECT** dial.

Note

- The function is not available in USB B and Audio in B modes.

Select a preset sound effect

The DSC (Digital Sound Control) enables you to enjoy special sound effects.

During play, press **DSC** repeatedly to select:

- [ROCK] (rock)
- [POP] (pop)
- [TECHNO] (techno)
- [JAZZ] (jazz)
- [SAMBA] (samba)

Enhance bass

The best DBB (Dynamic Bass Enhancement) setting is generated automatically for each DSC selection. You can manually select the DBB setting that best suits your listening environment.

- During play, press **DBB** repeatedly to select:
 - DBB 1
 - DBB 2
 - DBB 3
 - DBB OFF

Apply NX Bass

NX Bass effect adds clean and lively characteristics to your music with very low background noise.

- 1 Open the cover on the NX Bass button.
- 2 Press the NX Bass button. The sound will change in 3 stages:
 - Stage 1: The sound volume increases to a higher level and stays at this level for 5 seconds. The display panel shows [FIRING] (firing);
 - Stage 2: The sound volume gradually decreases to its original level in 10 seconds. The display panel shows [DISCHARGING] (discharging);
 - Stage 3: The sound volume keeps at normal level for 40 seconds. The display panel shows [RECHARGING] (recharging).



Note

- To reactivate the NX bass effect, press the button again after the 3 stages are completed.

Adjust equalizer settings

Custom Equalizer lets you increase/decrease the gain for specific frequency ranges, and adjust audio output to your own preferences.



- Move the slider bars to adjust the equalizer settings for each of the 5 frequency ranges.

10 Other features

- To adjust the volume of the source, press **VOL +/-**.
- To adjust the volume of the microphone, turn the **MIC** volume dial.

Mix sound

You can play from a **Source A** source (USB A/ Bluetooth/Tuner/Audio in A mode) and from a **Source B** source (USB B/Audio in B mode) at the same time.

- 1 Play from a **Source A** source.
 - Tuner - Tune to a radio station.
 - Audio in A - Select the Audio in A source, and then connect and start to play an external device.
 - USB A - Select the USB A mode, and connect a USB device to  A socket. Select a track and start playing.
 - Bluetooth - Connect and play from a Bluetooth device.
- 2 Play from a **Source B** source (Audio in B/ USB B mode).
 - Audio in B - Select the Audio in B source, and then connect and start to play an external device.
 - USB B - Select the USB B mode, and connect a USB device to  B socket. Select a track and start playing.
- 3 Use the **CROSS FADER ASSIGN** to adjust the left/right channel balance during playback.

Karaoke

You can connect a microphone and sing along with a music source.

- 1 Turn the **MIC** volume dial to the minimum level.
- 2 Connect a microphone to a microphone port **MIC 1/2** on the unit.
- 3 Press **TUNER**, or **USB A**, or **AUDIO A**, or **AUX** to select the source, and start play.
- 4 Sing through the microphone.

USB record



MP3 files, radio, and audio from external devices are recorded in .mp3 format.

The first time you record to a USB device, a folder is automatically created in the USB device. Each time you record to a USB device, the recorded files are stored in a subfolder in this folder. Files and subfolders are named numerically in the order in which they are created.

Note

- This function is only available in USB A mode.

Record to a USB device

- 1 Connect a USB device to  A socket.
- 2 Prepare the source to record from.
 - Radio - Tune to a radio station.
 - AUDIO IN/AUX - Select the Audio in/ AUX source, and then connect and start to play an external device.
 - **USB B** - Connect a "source" USB device to  B socket. Press **USB B** to select the **USB B** source, and select an audio file to play.
- 3 Press **USB RECORD** to start recording.
 - ↳ Play starts automatically from the beginning of the selected track, and the recording starts.
 - To stop recording, press **■**.

Note

- If the USB device does not have enough memory to store the audio files, a message about a full memory is displayed.
- This function is not available in Mix sound mode.
- This function is not available when **AUTO DJ** or **DJ EFFECT** effects are applied.

11 Product information

Note

- Product information is subject to change without prior notice.

Specifications

Amplifier

Total output power	650 W (THD30%, +/- 1dB)
Frequency response	60 Hz - 16kHz
Signal-to-noise ratio	>65 dBA
Audio In/Mp3 Link	1500mV/2000mV

Speakers

Speaker Impedance	3 ohm
-------------------	-------

Tuner

Tuning range	FM: 87.5 - 108MHz; AM: 531 - 1602kHz (9KHz); 530 - 1700kHz (10KHz)
Tuning grid	100KHz (FM); 9KHz/10KHz (AM)
Number of presets	30 FM, 10 AM
FM	75ohm wire
AM	loop antenna

General information

AC power	110V - 127V/220 - 240V, 50/60Hz
Operation power consumption	170 W
Standby power consumption	30 W
USB direct	Version 2.0/1.1
Dimensions	390 x 1137 x
Main Unit (W x H x D)	477 mm
Weight (without speakers)	26.3 kg

USB playability information

Compatible USB devices:

- USB flash memory (USB 2.0)
- USB flash players (USB 2.0)
- memory cards (requires an additional card reader to work with this unit)

Supported formats:

- USB or memory file format FAT12, FAT16, FAT32 (sector size: 512 bytes)
- MP3 bit rate (data rate): 32-320 Kbps and variable bit rate
- Directory nesting up to a maximum of 8 levels
- Number of albums/ folders: maximum 99
- Number of tracks/titles: maximum 999
- ID3 tag v1.2 or later
- File name in Unicode UTF8 (maximum length: 128 bytes)

Unsupported formats:

- Empty albums: an empty album is an album that does not contain MP3 files, and is not shown in the display.
- Unsupported file formats are skipped. For example, Word documents (.doc) or MP3 files with extension .dlf are ignored and not played.
- AAC, WAV, PCM audio files
- WMA files

12 Troubleshooting

Caution

- Never remove the casing of this unit.

To keep the warranty valid, never try to repair the system yourself.

If you encounter problems when using this unit, check the following points before requesting service. If the problem remains unsolved, go to the Philips web site (www.philips.com/support). When you contact Philips, ensure that your unit is nearby and the model number and serial number are available.

No power

- Ensure that the AC power plug of the unit is connected properly.
- Ensure that there is power at the AC outlet.
- To save power, the unit switches to standby automatically 15 minutes after a play reaches the end and no control is operated.

No sound or poor sound

- Adjust the volume.
- Check that the speakers are connected correctly.
- Check if the stripped speaker wires are clamped.

Left and right sound outputs reversed

- Check the speaker connections and location.

No response from the unit

- Disconnect and reconnect the AC power plug, then turn on the unit again.

Remote control does not work

- Before you press any function button, first select the correct source with the remote control instead of the main unit.
- Reduce the distance between the remote control and the unit.
- Insert the batteries with their polarities (+/- signs) aligned as indicated.
- Replace the batteries.

- Aim the remote control directly at the sensor on the front of the main unit.

Cannot display some files in USB device

- The number of folders or files in the USB device has exceeded a certain limit. This phenomenon is not a malfunction.
- The formats of these files are not supported.

USB device not supported

- The USB device is incompatible with the unit. Try another one.

Cannot apply sound effects when playing from a USB B device.

- USB B mode does not support **DBB**, **DSC**, **DJ EFFECT** or **AUTO DJ** effects.

Cannot delete files from a USB B device.

- USB B mode does not support USB Delete function.

Poor radio reception

- Increase the distance between the unit and your TV or VCR.
- If the signal is too weak, adjust the antenna or connect an external antenna for better reception.



Specifications are subject to change without notice
© 2013 Koninklijke Philips Electronics N.V.
All rights reserved.

NTRX510_x77_UM_EN_V1.0

