



Thank you for choosing Philips.

Need help fast?

Read your Quick Start Guide and/or User Manual first for quick tips that make using your Philips product more enjoyable.

If you have read your instructions and still need assistance, you may access our online help at www.philips.com/welcome



Philips vous remercie de votre confiance.

Besoin d'une aide rapide?

Le Guide rapide de début et Manuel de l'utilisateur regorgent d'astuces destinées à simplifier l'utilisation de votre produit Philips.

Toutefois, si vous ne parvenez pas à résoudre votre problème, vous pouvez accéder à notre aide en ligne à l'adresse www.philips.com/welcome



Gracias por escoger Philips

Necesita ayuda inmediata?

Lea primero la Guía rápida del comienzo o el Manual del usuario, en donde encontrará consejos que le ayudarán a disfrutar plenamente de su producto Philips.

Si después de leerlo aún necesita ayuda, consulte nuestro servicio de asistencia en línea en www.philips.com/welcome



A

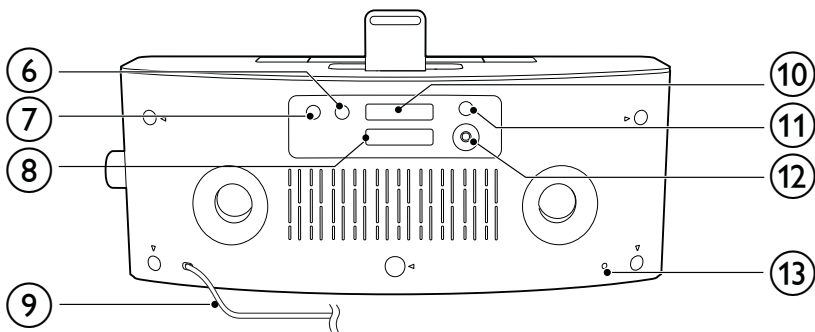
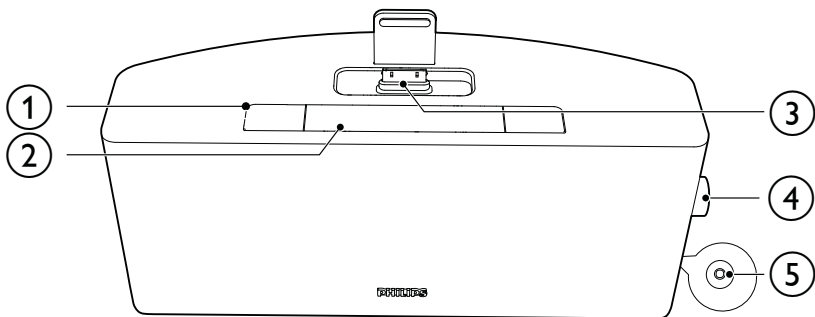

B

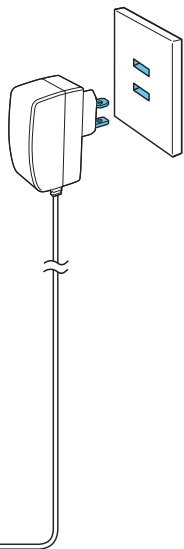
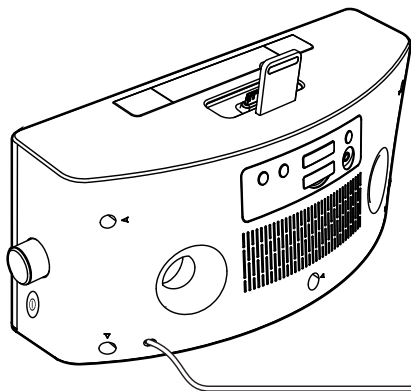

C











v2.2.1B0004



Theme



Share



Location



Temperature

°C

°F



Month/Day Revert

ON

OFF



Radio Auto Program

PHILIPS

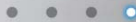

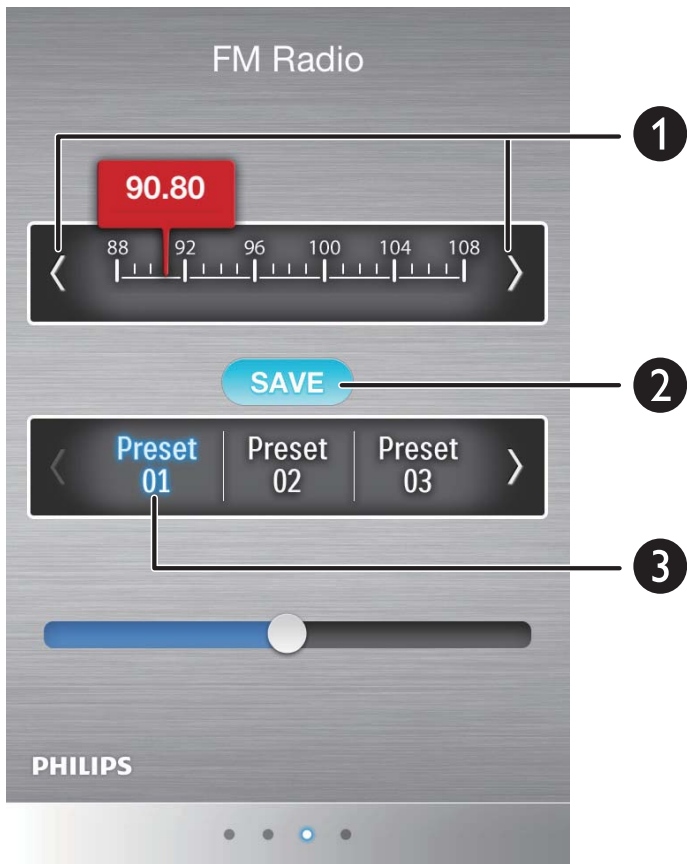

1 Important

Safety

Important Safety Instructions

- ① Read these instructions.
- ② Keep these instructions.
- ③ Heed all warnings.
- ④ Follow all instructions.
- ⑤ Do not use this apparatus near water.
- ⑥ Clean only with dry cloth.
- ⑦ Do not block any ventilation openings. Install in accordance with the manufacturer's instructions.
- ⑧ Do not install near any heat sources such as radiators, heat registers, stoves, or other apparatus (including amplifiers) that produce heat.

⑨ Protect the power cord from being walked on or pinched, particularly at plugs, convenience receptacles, and the point where they exit from the apparatus.

⑩ Only use attachments/accessories specified by the manufacturer.

⑪ Use only with the cart, stand, tripod, bracket, or table specified by the manufacturer or sold with the apparatus.

When a cart is used, use caution when moving the cart/apparatus combination to avoid injury from tip-over.



⑫ Unplug this apparatus during lightning storms or when unused for long periods of time.

⑬ Refer all servicing to qualified service personnel. Servicing is required when the apparatus has been damaged in any way, such as power-supply cord or plug is damaged, liquid has been spilled or objects have fallen into the apparatus, the apparatus has been exposed to rain or moisture, does not operate normally, or has been dropped.

- ⑭ **Battery usage CAUTION – To prevent battery leakage which may result in bodily injury, property damage, or damage to the unit:**
- Install all batteries correctly, + and - as marked on the unit.
 - Do not mix batteries (old and new or carbon and alkaline, etc.).
 - Remove batteries when the unit is not used for a long time.
- ⑮ **Apparatus shall not be exposed to dripping or splashing.**
- ⑯ **Do not place any sources of danger on the apparatus (e.g. liquid filled objects, lighted candles).**
- ⑰ **This product may contain lead and mercury. Disposal of these materials may be regulated due to environmental considerations. For disposal or recycling information, please contact your local authorities or the Electronic Industries Alliance: www.eiae.org.**
- ⑱ **Where the plug of the Direct Plug-in Adapter is used as the disconnect device, the disconnect device shall remain readily operable.**



Warning

- Never remove the casing of this clock radio.
- Never place this clock radio on other electrical equipment.
- Keep this clock radio away from direct sunlight, naked flames or heat.
- To reduce the risk of fire or electric shock, do not expose this apparatus to rain or moisture.
- Ensure that you always have easy access to the power cord, plug or adapter to disconnect this clock radio from the power.

2 Your Docking Entertainment System

Congratulations on your purchase, and welcome to Philips! To fully benefit from the support that Philips offers, register your product at www.philips.com/welcome.

If you contact Philips, you will be asked for the model and serial number of this apparatus. The model number and serial number are on the bottom of the apparatus. Write the numbers here:

Model No. _____

Serial No. _____

Introduction

With this clock radio, you can

- listen to FM radio;
- enjoy audio from iPod/iPhone or an external device;
- set alarms to ring at different time;
- choose buzzer, radio, or audio in iPod/iPhone as your alarm source;
- experience various features brought by **HomeStudio** app.

What's in the box

Check and identify the contents of your package:

- Main unit (with battery)
- User manual

Overview of the main unit (A)

① AL1/AL2

- Set alarm.
- View alarm settings.
- Activate/deactivate alarm timer.

② SNOOZE/BRIGHTNESS

- Snooze alarm.
- Adjust display brightness.

③ DOCK

- Dock for iPod/iPhone.

④ Volume knob

- Rotate to adjust volume or time.
- Press to confirm a selection.

⑤ ①

- Turn on/off the clock radio.

⑥ SLEEP

- Set sleep timer.

⑦ SOURCE

- Select source.

⑧ **Battery tray**

⑨ **Power cord**

⑩ **⏮ / ⏭**

- Tune or scan to an FM radio station.

⑪ **SET TIME**

- Set the time.

⑫ **MP3 LINK**

- Connect an external audio device.

⑬ **FM ANTENNA**

- Improve FM reception.

3 Get started



Caution

- Use of controls or adjustments or performance of procedures other than herein may result in hazardous radiation exposure or other unsafe operation.

Always follow the instructions in this chapter in sequence.

Install battery



Caution

- Risk of explosion! Keep batteries away from heat, sunshine, or fire. Never discard batteries in fire.
- Danger of explosion if battery is incorrectly replaced. Replace only with the same or equivalent type.
- The battery contains chemical substances, so it should be disposed of properly.
- Keep children away from the battery.
- Perchlorate Material - special handling may apply. See www.dtsc.ca.gov/hazardouswaste/perchlorate.



Note

- You can only use AC power as power supply. The pre-installed lithium CR2032 battery can only back up time and alarm.

For first-time use:

Remove the protective tab to activate the battery.

To replace the battery:

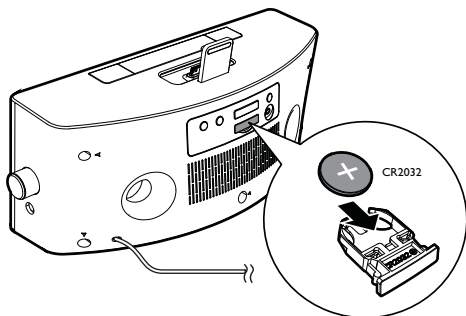

Connect power (B)



Caution

- Risk of product damage! Make sure that the power voltage corresponds to the voltage printed on the back or underside of the unit.
- Risk of electric shock! When you unplug the power adapter, always pull the plug from the socket. Never pull the cord.
- Before connecting the power adapter, make sure that you have completed all other connections.
- Use the supplied power adapter only.

Turn on

Press ①.

↳ The clock radio switches to the last selected source.

Switch to standby mode

Press ① to switch the clock radio to standby mode.

↳ The clock (if set) is displayed.

Set time and date

- 1 Press and hold **SET TIME** on the back of your clock radio for more than two seconds.
↳ **[12H]** or **[24H]** begins to blink.
- 2 Rotate the knob to select 12/24 hour format.
- 3 Press the knob to confirm.
↳ The hour digits begin to blink.
- 4 Repeat steps 2-3 to set hour and minute.



Note

- If clock is not manually set, when iPod/iPhone is connected, the unit synchronizes time from the iPod/iPhone automatically.



Tip

- The accuracy of the transmitted time depends on the docked iPod/iPhone that transmits the time signal.
-

4 Play

Play from iPod/iPhone

You can enjoy audio from iPod/iPhone through this clock radio.

Compatible iPod/iPhone

The unit supports the following iPod, iPhone models:

Made for:

- iPod classic
 - iPod touch (1st, 2nd, 3rd, and 4th generation)
 - iPod nano (1st, 2nd, 3rd, 4th, 5th, and 6th generation)
 - iPhone 4S
 - iPhone 4
 - iPhone 3GS
 - iPhone 3G
 - iPhone
-

Install HomeStudio App

Philips **HomeStudio** app brings a suite of new features to your clock radio, including FM radio programming and a multi-function alarm clock. To enjoy more features, you are recommended to install this free **HomeStudio** app.



Note

- Make sure that your iPod/iPhone is connected to the Internet.

- 1 Press **SOURCE** to select the **DOCK** mode.
- 2 Insert your iPod/iPhone into the dock.
- 3 For the first-time use, you will be asked to install **HomeStudio** app on your iPod/iPhone.
- 4 Tap **[Yes]** (yes) to accept the installation request.
- 5 Follow the on-screen instructions to complete the installation. ©

Philips **HomeStudio** app only can be installed in the following iPod, iPhone models:

- iPod touch (1st, 2nd, 3rd, and 4th generation)
- iPhone 4S
- iPhone 4
- iPhone 3GS
- iPhone 3G
- iPhone

Play music in the iPod/iPhone

Note

- Make sure that you have installed the **HomeStudio** app on your iPod/iPhone.

- 1 Tap **HomeStudio** icon on your iPod/iPhone.
↳ The clock/alarm setting screen appears. ⌚
- 2 Slide left to display the following screen. 📱
- 3 Select a track from the playlist, and then press ▶.
↳ Music streams from your iPod/iPhone to the clock radio.



Use more features with “HomeStudio App”



Note

- Make sure that your iPod/iPhone is inserted into the clock radio.

Set clock, alarm, and sleep timer:

- 1 Launch the **HomeStudio** app.
 - 2 On the screen below, tap the setting icon .
- ↳ You can set clock, sleep timer, and alarm for your clock radio. 





Note

- The alarms set with your clock radio will appear under **[Dock Alarm]** (dock alarm) category.
- You can also set more alarms by tapping  on the top right of the alarm setting screen.



Store FM radio stations manually:

- 1 Slide right to display the screen as below.
- 2 Press  /  to tune to a radio station.
- 3 Press **[SAVE]** (save), and then press a preset number.
 - ↳ **[SAVE]** (save) and the selected number turns blue.
 - ↳ The radio station is saved successfully.
- 4 If **[SAVE]** (save) is activated, you can tune to other stations, and press a number to save stations directly. 



Tip

- If you need not preset more stations, press **[SAVE]** (save) again to deactivate it (in gray).

Use more features:

Slide right to the next screen. You can:

- set the theme;
- share the information;
- set the location for weather report;
- choose temperature unit;
- select month/day display mode;
- store radio stations automatically by tapping **[Radio Auto Program]** (radio auto program).
 - ↳ **[Searching]** (searching) is displayed.
 - ↳ All available stations are stored.
 - ↳ The first stored radio station is broadcast automatically. 

Charge the iPod/iPhone

When your clock radio is connected to power, the docked iPod/iPhone begins to charge automatically.

Remove the iPod/iPhone

Pull the iPod/iPhone out of the dock.

Listen to radio



Note

- Keep the unit away from other electronic devices to avoid radio interference.
- For better reception, do not place iPod/iPhone into the dock when you listen to the radio. Fully extend and adjust the position of the FM antenna.

Tune to FM radio stations

You also can tune to radio stations from your clock radio.

- 1 Press **SOURCE** repeatedly to select FM tuner.
- 2 Press and hold **◀◀ / ▶▶** on the back of your clock radio for more than two seconds.
 - ↳ The radio tunes to a station with strong reception automatically.
- 3 Repeat step 2 to tune to more stations.

To tune to a station manually:

Press **◀◀ / ▶▶** repeatedly until you find optimal reception.

Play from an external device

You can also listen to an external audio device through this clock radio.

- 1 Press **SOURCE** to select the **AUX** source.
- 2 Connect the MP3 link cable (not supplied) to:
 - the **MP3-LINK** socket (3.5mm) at the back of your clock radio.
 - the headphone socket of an external device.
- 3 Start to play the device (see the user manual of the device).

Adjust volume

During play, you can rotate the knob to adjust volume.

5 Other features

Set alarm timer

Set alarm

You can set two alarms to ring at different time. Buzzer, FM radio, or your last listened audio in the iPod/iPhone can be selected as alarm sound.



Note

- Make sure that you have set the clock correctly.

- 1 Press and hold **AL1/AL2** for more than two seconds to activate alarm setting mode.
 - ↳ The hour digits and alarm icon begin to blink.
- 2 Rotate the knob to set the hour.
- 3 press the knob to confirm.
 - ↳ The minute digits begin to blink.
- 4 Repeat steps 2-3 to set the minute, select an alarm source (buzzer, radio, or dock), and adjust the volume.



Note

- If iPod/iPhone is selected as alarm source, but no iPod/iPhone is connected, the clock radio switches to buzzer source instead.
- For the alarm(s) set through the clock radio, you can also select the nature sounds stored in the **HomeStudio** app as alarm sound.

Activate/deactivate alarm timer

- 1 Press **AL1/AL2** to view alarm settings.
- 2 Press **AL1/AL2** again to activate or deactivate the alarm timer.
 - ↳ **1** or **2** is displayed if alarm timer is on and disappears if it is off.
 - To stop the ringing alarm, press the corresponding **AL1/AL2**.
 - ↳ The alarm repeats ringing for the next day.

Snooze alarm

When alarm sounds, press **SNOOZE**.

- ↳ The alarm snoozes and repeats ringing nine minutes later.

Set sleep timer

This clock radio can switch to standby mode automatically after a preset period.

Press **SLEEP** repeatedly to select the sleep timer period (in minutes).

- ↳ When the sleep timer is activated, **zZ** appears.

To deactivate the sleep timer, press **SLEEP** repeatedly until clock time appears.

Adjust display brightness

Press **BRIGHTNESS** repeatedly to select different brightness levels.

6 Product information



Note

- Product information is subject to change without prior notice.

Specifications

Amplifier

Rated Output Power	2 x 5 W RMS
Frequency Response	63-16 kHz
Signal to Noise Ratio	>50 dB
Total Harmonic Distortion	<15%
Aux Input (MP3 link)	0.6 V RMS 10 k ohm

Tuner (FM)

Tuning range	87.5-108 MHz
Tuning grid	100 KHz

Speakers

Speaker Impedance	4 ohm
-------------------	-------

Sensitivity

>82 dB/m/W

General information

AC power (power adapter)

Brand name: Philips;
Model: YJS03-0901500U;
Input: 100-240V~, 50/60 Hz;
Output: 9 V $\overline{=}$ 1.5 A

Operation Power Consumption

<20 W

Standby Power Consumption

<1 W

Dimensions: Main Unit (W x H x D)

283 x 135 x 112 mm

Weight:

-Main Unit

1.39 kg

-With Packing

1.75 kg

7 Troubleshooting



Warning

- Never remove the casing of this device.

To keep the warranty valid, never try to repair the system yourself. If you encounter problems when using this device, check the following points before requesting service. If the problem remains unsolved, go to the Philips Web page (www.philips.com/support). When you contact Philips, make sure that the device is nearby and the model number and serial number are available.

No power

- Ensure that the AC power plug of the unit is connected properly.
- Ensure that there is power at the AC outlet.

No sound

- Adjust the volume.

No response from the unit

- Disconnect and reconnect the AC power plug, then turn on the unit again.

Poor radio reception

- Increase the distance between the unit and your TV or VCR.
- Fully extend the FM aerial.

Alarm does not work

- Set the clock/alarm correctly.

Clock/alarm setting erased

- Power has been interrupted or the power plug has been disconnected.
- Reset the clock/alarm.

8 Notice

Any changes or modifications made to this device that are not expressly approved by Philips Consumer Lifestyle may void the user's authority to operate the equipment.

Notice for the USA

This equipment has been tested and found to comply with the limits for a Class B digital device, pursuant to part 15 of the FCC Rules. These limits are designed to provide reasonable protection against harmful interference in a residential installation. This equipment generates, uses, and can radiate radio frequency energy and, if not installed and used in accordance with the instruction manual, may cause harmful interference to radio communications.

However, there is no guarantee that interference will not occur in a particular installation. If this equipment does cause harmful interference to radio or television reception, which can be determined by turning the equipment off and on, the user is encouraged to try to correct the interference by one or more of the following measures:

- Relocate the receiving antenna.
- Increase the separation between equipment and receiver.
- Connect the equipment into an outlet on a circuit different from that to which the receiver is connected.
- Consult the dealer or an experienced radio/TV technician for help.

The set complies with the FCC-Rules, Part 15 and with 21 CFR 1040.10. Operation is subject to the following two conditions:

1. This device may not cause harmful interference, and
2. This device must accept any interference received, including interference that may cause undesired operation.

This digital apparatus does not exceed the Class B limits for radio noise emissions from digital apparatus as set out in the Radio Interference

Regulations of the Canadian Department of Communications. This Class B digital apparatus complies with Canadian ICES-003.

Your product is designed and manufactured with high quality materials and components, which can be recycled and reused.

Never dispose of your product with other household waste. Please inform yourself about the local rules on the separate collection of electrical and electronic products and batteries. The correct disposal of these products helps prevent potentially negative consequences on the environment and human health.

Your product contains batteries, which cannot be disposed of with normal household waste.

Please inform yourself about the local rules on separate collection of batteries. The correct disposal of batteries helps prevent potentially negative consequences on the environment and human health.

Please visit www.recycle.philips.com for additional information on a recycling center in your area.

Environmental information

All unnecessary packaging has been omitted. We have tried to make the packaging easy to separate into three materials: cardboard (box), polystyrene foam (buffer) and polyethylene (bags, protective foam sheet.)

Your system consists of materials which can be recycled and reused if disassembled by a specialized company. Please observe the local regulations regarding the disposal of packaging materials, exhausted batteries and old equipment.

Made for



iPod



iPhone

“Made for iPod” and “Made for iPhone” mean that an electronic accessory has been designed to connect specifically to iPod or iPhone respectively, and has been certified by the developer to meet Apple performance standards. Apple

is not responsible for the operation of this device or its compliance with safety and regulatory standards. Please note that the use of this accessory with iPod or iPhone may affect wireless performance.

iPod and iPhone are trademarks of Apple Inc., registered in the U.S. and other countries.

2012 © Koninklijke Philips Electronics N.V. All rights reserved.

Specifications are subject to change without notice. Trademarks are the property of Koninklijke Philips Electronics N.V. or their respective owners. Philips reserves the right to change products at any time without being obliged to adjust earlier supplies accordingly.



Note

- The type plate is located on the bottom of the apparatus.

Register online at www.philips.com/welcome today to
get the very most from your purchase.

Registering your model with PHILIPS makes you eligible for all of the valuable benefits listed below, so don't miss out. Register online at www.philips.com/welcome to ensure:

*Product Safety Notification

By registering your product, you'll receive notification - directly from the manufacturer.

*Additional Benefits

Registering your product guarantees that you'll receive all of the privileges to which you're entitled, including special money-saving offers.

PHILIPS

*Congratulations on your purchase,
and welcome to the "family!"*

Dear PHILIPS product owner:

Thank you for your confidence in PHILIPS. You've selected one of the best-built, best-backed products available today. We'll do everything in our power to keep you happy with your purchase for many years to come.

As a member of the PHILIPS "family," you're entitled to protection by one of the most comprehensive warranties in the industry. What's more, your purchase guarantees you'll receive all the information and special offers for which you qualify, plus easy access to accessories from our convenient home shopping network.

Most importantly, you can count on our uncompromising commitment to your total satisfaction.

All of this is our way of saying welcome - and thanks for investing in a PHILIPS product.

P.S. To get the most from your PHILIPS purchase, be sure to register online at:

www.philips.com/welcome

Know these
safety symbols



This "bolt of lightning" indicates uninsulated material within your unit may cause an electrical shock. For the safety of everyone in your household, please do not remove product covering.

The "exclamation point" calls attention to features for which you should read the enclosed literature closely to prevent operating and maintenance problems.

WARNING: To reduce the risk of fire or electric shock, this apparatus should not be exposed to rain or moisture and objects filled with liquids, such as vases, should not be placed on this apparatus.

CAUTION: To prevent electric shock, match wide blade of plug to wide slot, fully insert.

ATTENTION: Pour éviter les choc électriques, introduire la lame la plus large de la fiche dans la borne correspondante de la prise et pousser jusqu'au fond.

For Customer Use

Enter below the Serial No. which is located on the rear of the cabinet. Retain this information for future reference.

Model No. _____
Serial No. _____

PHILIPS

Visit our World Wide Web Site at <http://www.philips.com/welcome>

PHILIPS LIMITED WARRANTY ONE (1) YEAR

WARRANTY COVERAGE:

PHILIPS warranty obligation is limited to the terms set forth below.

WHO IS COVERED:

Philips warrants the product to the original purchaser or the person receiving the product as a gift against defects in materials and workmanship as based on the date of original purchase ("Warranty Period") from an Authorized Dealer. The original sales receipt showing the product name and the purchase date from an authorized retailer is considered such proof.

WHAT IS COVERED:

The Philips warranty covers new products if a defect in material or workmanship occurs and a valid claim is received by Philips within the Warranty Period. At its option, Philips will either (1) repair the product at no charge, using new or refurbished replacement parts, or (2) exchange the product with a product that is new or which has been manufactured from new, or serviceable used parts and is at least functionally equivalent or most comparable to the original product in Philips current inventory, or (3) refund the original purchase price of the product. Philips warrants replacement products or parts provided under this warranty against defects in materials and workmanship from the date of the replacement or repair for ninety (90) days or for the remaining portion of the original product's warranty, whichever provides longer coverage for you. When a product or part is exchanged, any replacement item becomes your property and the replaced item becomes Philips' property. When a refund is given, your product becomes Philips' property.

Note: Any product sold and identified as refurbished or renewed carries a ninety (90) day limited warranty.

Replacement product can only be sent if all warranty requirements are met. Failure to follow all requirements can result in delay.

WHAT IS NOT COVERED - EXCLUSIONS AND LIMITATIONS:

This Limited Warranty applies only to the new products manufactured by or for Philips that can be identified by the trademark, trade name, or logo affixed to it. This Limited Warranty does not apply to any non-Philips hardware product or any software, even if packaged or sold with the product. Non-Philips manufacturers, suppliers, or publishers may provide a separate warranty for their own products packaged with the bundled product.

Philips is not liable for any damage to or loss of any programs, data, or other information stored on any media contained within the product, or any non-Philips product or part not covered by this warranty. Recovery or reinstallation of programs, data or other information is not covered under this Limited Warranty.

This warranty does not apply (a) to damage caused by accident, abuse, misuse, neglect, misapplication, or non-Philips product, (b) to damage caused by service performed by anyone other than Philips or Philips Authorized Service Location, (c) to a product or a part that has been modified without the written permission of

Philips, or (d) if any Philips serial number has been removed or defaced, or (e) product, accessories or consumables sold "AS IS" without warranty of any kind by including refurbished Philips product sold "AS IS" by some retailers.

This Limited Warranty does not cover:

- Shipping charges to return defective product to Philips.
- Labor charges for installation or setup of the product, adjustment of customer controls on the product, and installation or repair of antenna/signal source systems outside of the product.
- Product repair and/or part replacement because of improper installation or maintenance, connections to improper voltage supply, power line surge, lightning damage, retained images or screen markings resulting from viewing fixed stationary content for extended periods, product cosmetic appearance items due to normal wear and tear, unauthorized repair or other cause not within the control of Philips.
- Damage or claims for products not being available for use, or for lost data or lost software.
- Damage from mishandled shipments or transit accidents when returning product to Philips.
- A product that requires modification or adaptation to enable it to operate in any country other than the country for which it was designed, manufactured, approved and/or authorized, or repair of products damaged by these modifications.
- A product used for commercial or institutional purposes (including but not limited to rental purposes).
- Product lost in shipment and no signature verification receipt can be provided.
- Failure to operate per Owner's Manual.

TO OBTAIN ASSISTANCE IN THE U.S.A., PUERTO RICO, OR U.S. VIRGIN ISLANDS...

Contact Philips Customer Care Center at:
1-888-PHILIPS (1-888-744-5477)

TO OBTAIN ASSISTANCE IN CANADA...

1-800-661-6162 (French Speaking)
1-888-PHILIPS (1-888-744-5477) - (English or Spanish Speaking)

REPAIR OR REPLACEMENT AS PROVIDED UNDER THIS WARRANTY IS THE EXCLUSIVE REMEDY FOR THE CONSUMER. PHILIPS SHALL NOT BE LIABLE FOR ANY INCIDENTAL OR CONSEQUENTIAL DAMAGES FOR BREACH OF ANY EXPRESS OR IMPLIED WARRANTY ON THIS PRODUCT. EXCEPT TO THE EXTENT PROHIBITED BY APPLICABLE LAW, ANY IMPLIED WARRANTY OF MERCHANTABILITY OR FITNESS FOR A PARTICULAR PURPOSE ON THIS PRODUCT IS LIMITED IN DURATION TO THE DURATION OF THIS WARRANTY.

Some states do not allow the exclusions or limitation of incidental or consequential damages, or allow limitations on how long an implied warranty lasts, so the above limitations or exclusions may not apply to you.

This warranty gives you specific legal rights. You may have other rights which vary from state/province to state/province.

Philips, P.O. Box 10313 Stamford, CT 06904

3140 035 50201



Specifications are subject to change without notice
© 2012 Koninklijke Philips Electronics N.V.
All rights reserved.

AJ7035D_37_UM_V1.2

