

Register your product and get support at
www.philips.com/welcome

Mini Hi-Fi System

FWM208



EN User manual

PHILIPS

Contents

1 Important	2
Safety	2
Notice	2

2 Your Mini Hi-Fi System	3
Introduction	3
What's in the box	3
Overview of the main unit	4
Overview of the remote control	5

3 Get started	7
Install remote control batteries	7
Connect speakers	7
Connect power	7
Set the clock	8
Turn on	8
Switch to standby	8

4 Play	9
Play disc	9
Play from USB	9

5 Play options	10
Repeat play	10
Play a track repeatedly	10
Play all tracks or an album repeatedly	10
Random play	10
Program tracks	10

6 Listen to the radio	11
Tune to a radio station	11
Program radio stations automatically	11
Program radio stations manually	11
Select a preset radio station	11

7 Adjust sound	12
Adjust volume	12
Select a preset sound effect	12
Enhance bass	12
Mute sound	12

8 Other features	13
Listen to an external device	13
Set the sleep timer	13
Set the alarm timer	13
Activate and deactivate alarm timer	13
Listen through headphone	13

9 Product information	14
Specifications	14
Amplifier	14
Disc	14
Tuner	14
FM	14
MW	14
Speakers	14
General information	14
USB playability information	15
Supported MP3 disc formats	15

10 Troubleshooting	16
---------------------------	-----------

1 Important

Safety

- Do not block any ventilation openings. Install in accordance with the manufacturer's instructions.
- Do not install near any heat sources such as radiators, heat registers, stoves, or other apparatus (including amplifiers) that produce heat.
- Protect the power cord from being walked on or pinched, particularly at plugs, convenience receptacles, and the point where they exit from the apparatus.
- Only use attachments/accessories specified by the manufacturer.
- Unplug this apparatus during lightning storms or when unused for long periods of time.
- Refer all servicing to qualified service personnel. Servicing is required when the apparatus has been damaged in any way, such as power-supply cord or plug is damaged, liquid has been spilled or objects have fallen into the apparatus, the apparatus has been exposed to rain or moisture, does not operate normally, or has been dropped.
- Battery usage CAUTION – To prevent battery leakage which may result in bodily injury, property damage, or damage to the unit:
 - Install all batteries correctly, + and - as marked on the unit.
 - Do not mix batteries (old and new or carbon and alkaline, etc.).
 - Remove batteries when the unit is not used for a long time.
- The device shall not be exposed to dripping or splashing.
- Do not place any sources of danger on the device (e.g. liquid filled objects, lighted candles).
- Where the MAINS plug or an appliance coupler is used as the disconnect device, the disconnect device shall remain readily operable.



Warning

- Never remove the casing of this apparatus.
- Never lubricate any part of this apparatus.
- Never place this apparatus on other electrical equipment.
- Keep this apparatus away from direct sunlight, naked flames or heat.
- Ensure that you always have easy access to the power cord, plug or adaptor to disconnect the apparatus from the power.

Notice

Any changes or modifications made to this device that are not expressly approved by Philips Consumer Lifestyle may void the user's authority to operate the equipment.

Environmental information

All unnecessary packaging has been omitted. We have tried to make the packaging easy to separate into three materials: cardboard (box), polystyrene foam (buffer) and polyethylene (bags, protective foam sheet.) Your system consists of materials which can be recycled and reused if disassembled by a specialized company. Please observe the local regulations regarding the disposal of packaging materials, exhausted batteries and old equipment.



Windows Media and the Windows logo are trademarks, or registered trademarks of Microsoft Corporation in the United States and/or other countries.

This apparatus includes this label:



Class I equipment symbol



This symbol indicates that the apparatus has a double insulation system.

2 Your Mini Hi-Fi System

Congratulations on your purchase, and welcome to Philips! To fully benefit from the support that Philips offers, register your product at www.philips.com/welcome.

Introduction

With this unit, you can enjoy audio from discs, USB devices and other external devices, or radio stations.

The unit offers you multiple sound effect settings that enrich sound with Digital Sound Control (DSC) and Dynamic Bass Boost (DBB). The unit supports the following media formats:



What's in the box



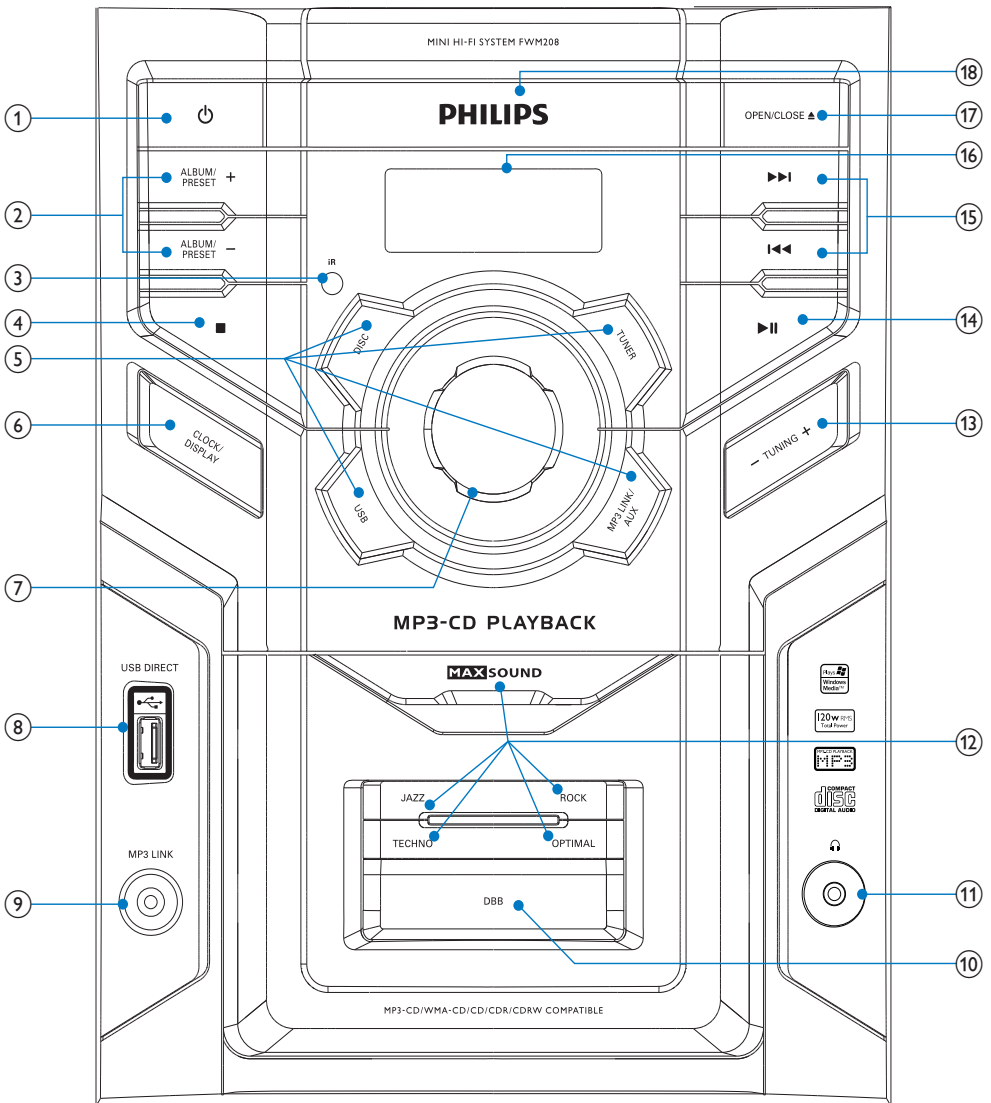

Check and identify the contents of your package:

- Main unit
- Speaker box x 2
- Remote control
- Power cable
- MP3 link cable
- User manual
- Quick start guide

Overview of the main unit





- ①
 - Turn on the unit.
 - Switch to standby mode.
- ② ALBUM/PRESET +/-
 - Select a preset radio station.
 - Skip to the previous/next album.
- ③ IR sensor

- ④ ■
- Stop play or erase a program.
- ⑤ **Source buttons (DISC, TUNER, USB, MP3 LINK/AUX)**
- Select a source: DISC, TUNER, USB, MP3 LINK, or AUX.
- ⑥ **CLOCK/DISPLAY**
- Set the clock.
 - During play, display the clock.
- ⑦ **Volume control**
- Adjust volume.
- ⑧  Jack for a USB mass storage device.
- ⑨ **MP3 LINK**
- Audio input jack (3.5mm) for an external audio device.
- ⑩ **DBB**
- Turns on or off dynamic bass enhancement.
- ⑪  Jack for headphones.
- ⑫ **MAX SOUND/JAZZ/ROCK/TECHNO/OPTIMAL**
- Select a preset sound setting.
- ⑬ **TUNING+/-**
- Tune to a radio station.
- ⑭  Start or pause play.
- ⑮  Skip to the previous/next track.
- Search within a track/disc.
 - Adjust time.
- ⑯ **Display panel**
- Show current status.
- ⑰ **OPEN/CLOSE▲**
- Open or close the disc compartment.
- ⑱ **Disc compartment**

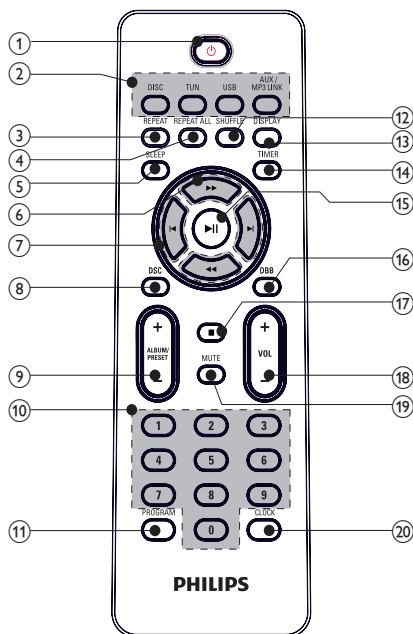
Overview of the remote control



- ①  Turn on the unit, switch to standby mode, or switch to Eco power standby.
- ② **Source buttons (DISC, TUN, USB, AUX/MP3 LINK)**
- Select a source: DISC, TUNER, USB, or AUX/MP3 LINK.
- ③ **REPEAT**
- Play a track repeatedly.
- ④ **REPEAT ALL**
- Play all tracks repeatedly.
- ⑤ **SLEEP**
- Set the sleep timer.
- ⑥  Search within a track/disc.
- Tune to a radio station.

- ⑦ **⏮/⏭**
 - Skip to the previous/next track.
 - Adjust time.
- ⑧ **DSC**
 - Select a preset sound setting.
- ⑨ **ALBUM/PRESET +/-**
 - Select a preset radio station.
 - Skip to the previous/next album.
- ⑩ **Numeric keypad**
 - Select a track from a disc directly.
 - Select a preset radio station directly.
- ⑪ **PROGRAM**
 - Program tracks.
 - Program radio stations.
 - Review the program.
- ⑫ **SHUFFLE**
 - Play tracks randomly.
- ⑬ **DISPLAY**
 - During play, display the clock.
- ⑭ **TIMER**
 - Set the alarm timer.
 - Review the alarm timer.
- ⑮ **▶||**
 - Start or pause play.
- ⑯ **DBB**
 - Turns on or off dynamic bass enhancement.
- ⑰ **■**
 - Stop play or erase a program.
- ⑱ **VOL +/-**
 - Adjust volume.
- ⑲ **MUTE**
 - Mute volume.
- ⑳ **CLOCK**
 - Set the clock.

3 Get started

Caution

- Use of controls or adjustments or performance of procedures other than herein may result in hazardous radiation exposure or other unsafe operation.

Always follow the instructions in this chapter in sequence.

If you contact Philips, you will be asked for the model and serial number of this apparatus. The model number and serial number are on the back of the apparatus. Write the numbers here:

Model No. _____

Serial No. _____

Install remote control batteries

Caution

- Risk of explosion! Keep batteries away from heat, sunshine or fire. Never discard batteries in fire.
- Risk of decreased battery life! Never mix different brands or types of batteries.
- Risk of product damage! When the remote control is not used for long periods, remove the batteries.

- 1 Open the battery compartment.
- 2 Insert 2 AAA batteries with correct polarity (+/-) as indicated.
- 3 Close the battery compartment.

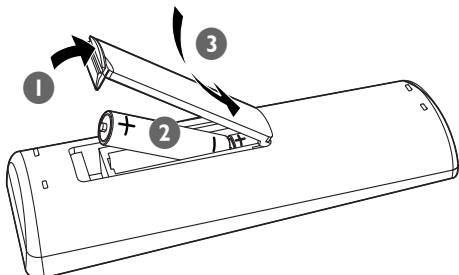

Connect speakers

- 1 Plug the two gray-blue cables into the "HIGH CH" sockets as indicated by the "+/-" symbols, right speaker to "R" and left speaker to "L".
- 2 Plug the two red-black cables into the "LOW CH" sockets as indicated by the "+/-" symbols, right speaker to "R" and left speaker to "L".

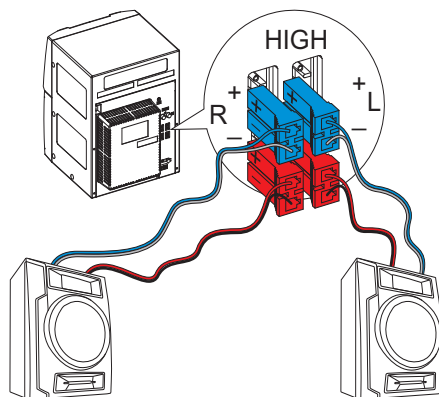

Connect power

Caution

- Risk of product damage! Ensure that the power supply voltage corresponds to the voltage set on the voltage selector on the back of the unit.
- Before connecting the AC power cord, ensure you have completed all other connections.

Note

- The type plate is located on the back of the main unit.

- 1 If your power supply voltage is 110V-127V, adjust the voltage selector to 110V-127V.
- 2 Connect the AC power cable to:
 - the main unit.
 - the wall socket.

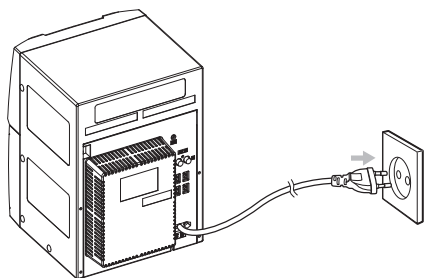

Turn on

- 1 Press **⏻**.
 - ↳ The unit switches to the last selected source.

Switch to standby

- 1 Press **⏻** to switch the unit to standby mode.
 - ↳ The clock (if set) appears on the display panel.

Set the clock

- 1 In standby mode, press and hold **CLOCK**.
 - ↳ The hour digits are displayed and begin to blink.
- 2 Press **⏪/⏩** (or **⏪/⏩** on the main unit) to set the hours.
- 3 Press **CLOCK**.
 - ↳ The minute digits are displayed and begin to blink.
- 4 Press **⏪/⏩** (or **⏪/⏩** on the main unit) to set the minutes.
- 5 Press **CLOCK** to confirm the time.

Tip

During play, you can press **DISPLAY** to view the clock.

4 Play

Play disc

- 1 Press **DISC** to select the disc source.
- 2 Press **OPEN/CLOSE**▲ on the front panel to open the disc tray.
- 3 Insert a disc with the printed side facing up, then close the disc tray.
 - ↳ Play starts automatically.
 - To pause/resume play, press ►||.
 - To stop play, press ■.
 - For MP3/WMA disc: to select an album, press **ALBUM/PRESET +/-**.
 - To skip to a track, press ◀/▶.
 - To search within a track, press and hold ◀◀/▶▶. Release to resume normal play.

- ↳ Play starts automatically.
 - To pause/resume play, press ►||.
 - To stop play, press ■.
 - To select an album, press **ALBUM/PRESET +/-**.
 - To skip to a track, press ◀/▶.
 - To search within a track, press and hold ◀◀/▶▶. Release to resume normal play.

Play from USB



Note

- Ensure that the USB device contains playable audio content.

- 1 Connect the USB device into the  socket.

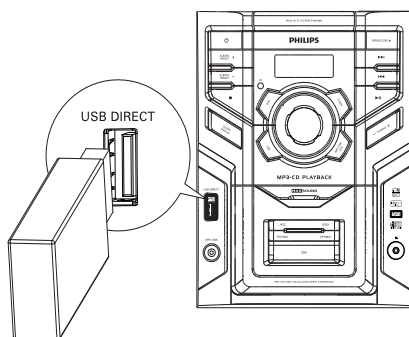

- 2 Press **USB** to select the USB source.

5 Play options

Repeat play

Play a track repeatedly

- 1 During play, press **REPEAT** on the remote control.
↳ [REPEAT] (repeat) is displayed. The current track is played repeatedly.
- 2 To return to normal play, press **REPEAT** again.

Play all tracks or an album repeatedly

- 1 During play, press **REPEAT ALL** on the remote control:
 - [REPEAT ALL] (repeat all) is displayed. All tracks are played repeatedly.
- 2 To return to normal play, press **REPEAT ALL** again.

Random play

- 1 Press **SHUFFLE**.
↳ [SHUF] (shuffle) is displayed. All tracks are played randomly.
- 2 To return to normal play, press **SHUFFLE** again.



Tip

- Shuffle play cannot be selected when you play programmed tracks.
- You can activate [SHUF] (shuffle) and [REPEAT ALL] (repeat all) at the same time.

Program tracks

You can program a maximum of 20 tracks.

- 1 At CD mode, in the stop position, press **PROGRAM** to activate the program mode.
↳ [PROG] (program) blinks on the display.
- 2 For MP3/WMA tracks, press **ALBUM/PRESET +/-** to select an album.
- 3 Press **◀▶** to select a track number, then press **PROGRAM** to confirm.
- 4 Repeat steps 2 to 3 to program more tracks.
- 5 Press **▶||** to play the programmed tracks.
↳ During play, [PROG] (program) is displayed.
 - To erase the program, in the stop position, press **■**.

6 Listen to the radio

Tune to a radio station



Tip

- For optimal FM reception, fully extend and adjust the position of the FM antenna.
- For optimal MW reception, adjust the position of the main unit.

- 1 Press **TUN** on the remote control to select the tuner source.
- 2 Press **TUN** to select FM or MW.
- 3 Press and hold **◀▶** for more than 2 seconds.
 - ↳ [SEARCH] (search) is displayed.
 - ↳ The radio tunes to a station with strong reception automatically.
- 4 Repeat step 3 to tune to more stations.
 - To tune to a weak station, press **◀▶** repeatedly until you find optimal reception.

Program radio stations automatically



Note

- You can program a maximum of 20 preset radio stations.

- 1 In tuner mode, press and hold **PROGRAM** for 2 seconds to activate automatic program mode.
 - ↳ [AUTO] (auto) is displayed and begins to blink.
 - ↳ All available stations are programmed in the order of waveband reception strength.

- ↳ The first programmed radio station is broadcast automatically.

Program radio stations manually



Note

- You can program a maximum of 20 preset radio stations.

- 1 Tune to a radio station.
- 2 Press **PROGRAM** to activate program mode.
 - ↳ [PROG] (program) blinks on the display.
- 3 Press **ALBUM/PRESET +/-** to allocate a number (1 to 20) to this radio station, then press **PROGRAM** to confirm.
 - ↳ The preset number and the frequency of the preset station are displayed.
- 4 Repeat the above steps to program other stations.



Note

- To overwrite a programmed station, store another station in its place.

Select a preset radio station

- 1 In tuner mode, press **ALBUM/PRESET +/-** to select a preset number.

7 Adjust sound

Adjust volume

- 1 During play, press **VOL +/-** to increase/decrease the volume.

Select a preset sound effect

- 1 During play, press **DSC** repeatedly to select:
 - [OPTIMAL] (optimal)
 - [JAZZ] (jazz)
 - [TECHNO] (techno)
 - [ROCK] (rock)

Enhance bass

- 1 During play, press **DBB** to turn on or off dynamic bass enhancement.
↳ If DBB is activated, DBB is displayed.

Mute sound

- 1 During play, press **MUTE** to mute/unmute sound.

8 Other features

Listen to an external device

You can also listen to an external audio device through this audio system.

For an audio device with a headphone socket:

- 1 Press **MP3 LINK** repeatedly to select the MP3 link source.
- 2 Connect the supplied MP3 link cable to:
 - the **MP3 LINK** socket on this unit.
 - the headphone socket on an MP3 player.
- 3 Start to play the MP3 player. (See the user manual of the MP3 player)

For other audio devices:

- 1 Press **MP3-LINK** repeatedly to select the AUX source.
- 2 Connect the audio cables to:
 - the **AUX IN** sockets on this unit.
 - the audio out sockets on the audio device.
- 3 Start to play the device. (See the device user manual)

Set the sleep timer

This unit can switch to standby automatically after a set period of time.

- 1 When the unit is turned on, press **SLEEP** repeatedly to select a set period of time (in minutes).
 - ↳ When sleep timer is activated, the display shows **zz**.
- 2 Press **SLEEP** repeatedly until "SLP OFF" is displayed.
 - ↳ When sleep timer is deactivated, **zz** disappears on the display.

Set the alarm timer

This unit can be used as an alarm clock. The last selected source is activated to play at a preset time.

- 1 Ensure that you have set the clock correctly.
- 2 Press and hold **TIMER** for more than 2 seconds.
 - ↳ The hour digits are displayed and begin to blink.
- 3 Press **◀▶** to set the hour.
- 4 Press **TIMER** to confirm.
 - ↳ The minute digits are displayed and begin to blink.
- 5 Press **◀▶** to set the minute.
- 6 Press **TIMER** to confirm.
 - ↳ The timer is set and activated.

To select a source to activate as the alarm sound:

- 1 Press **DISC**, **TUN**, **USB**, or **MP3 LINK** to select a source.
 - For **DISC**: ensure that there is a disc in the disc compartment.
 - For **TUNER**: tune to radio station.
 - For **USB**: connect a USB device.
 - For **MP3 LINK/AUX**: ensure that the external device is connected and turned on.
- 2 Press **⏻** to switch the unit to standby.

Activate and deactivate alarm timer

- 1 Press **TIMER** repeatedly to activate or deactivate timer.
 - ↳ If timer is activated, the display shows **⌚**.
 - ↳ If timer is deactivated, **⌚** disappears on the display.

Listen through headphone

- 1 Plug a headphone into the **🎧** socket on the unit.

9 Product information



Note

- Product information is subject to change without prior notice.

Specifications

Amplifier

Rated Output Power	4X30W RMS
Frequency Response	63 - 16000 Hz, ± 3 dB
Signal to Noise Ratio	>62dB

Disc

Laser Type	Semiconductor
Disc Diameter	12cm/8cm
Support Disc	CD-DA, CD-R, CD-RW, MP3-CD, WMA-CD
Audio DAC	24Bits / 44.1kHz
Total Harmonic Distortion	<1%
Frequency Response	63Hz - 16kHz
S/N Ratio	>65dBA

Tuner

FM

Tuning Range	87.5 - 108 MHz
Tuning grid	50 KHz
Sensitivity	<22 dBu
- Mono, 26dB S/N Ratio	<45 dBu
- Stereo, 46dB S/N Ratio	
Search Selectivity	<28 dBu
Total Harmonic Distortion	<3%
Signal to Noise Ratio	>45 dB

MW

Tuning Range	530 - 1700 kHz
--------------	----------------

Speakers

Speaker Impedance	4ohm
-------------------	------

General information

AC power	110 - 127V/220 - 240V, 50/60Hz
Operation power consumption	55W
Standby power consumption	8W
USB direct	Version 2.0/1.1
Dimensions	292 x 285 x 220
- Main Unit (W x H x D)	mm
- Speaker Box (W x H x D)	310 x 207 x 186 mm
Weight	3.8 kg
- Main Unit	1.3 kg
- Speaker Box	

USB playability information

Compatible USB devices:

- USB flash memory (USB 2.0 or USB1.1)
- USB flash players (USB 2.0 or USB1.1)
- memory cards (requires an additional card reader to work with this unit)

Supported formats:

- USB or memory file format FAT12, FAT16, FAT32 (sector size: 512 bytes)
- MP3 bit rate (data rate): 32-320 Kbps and variable bit rate
- WMA v9 or earlier
- Directory nesting up to a maximum of 8 levels
- Number of albums/ folders: maximum 99
- Number of tracks/titles: maximum 999
- File name in Unicode UTF8 (maximum length: 128 bytes)

Unsupported formats:

- Empty albums: an empty album is an album that does not contain MP3/WMA files, and will not be shown in the display.
- Unsupported file formats are skipped. For example, Word documents (.doc) or MP3 files with extension .dlf are ignored and not played.
- AAC, WAV, PCM audio files
- DRM protected WMA files (.wav, .m4a, .m4p, .mp4, .aac)
- WMA files in Lossless format

- Directory nesting up to a maximum of 8 levels
- Supported sampling frequencies: 32 kHz, 44.1kHz, 48 kHz
- Supported Bit-rates: 32~256 (kbps), variable bit rates
- ID3 tag v2.0 or later

Supported MP3 disc formats

- ISO9660, Joliet
- Maximum title number: 511 (depending on file name length)
- Maximum album number: 511

10 Troubleshooting



Warning

- Never remove the casing of this apparatus.

To keep the warranty valid, never try to repair the system yourself.

If you encounter problems when using this apparatus, check the following points before requesting service. If the problem remains unsolved, go to the Philips web site (www.philips.com/welcome). When you contact Philips, ensure that the apparatus is nearby and the model number and serial number are available.

No power

- Ensure that the AC power plug of the unit is connected properly.
- Ensure that there is power at the AC outlet.
- To save power, the system switches off automatically 15 minutes after track play reaches the end and no control is operated.

No sound or poor sound

- Adjust the volume.
- Check that the speakers are connected correctly (for example, the +/- polarity).
- Check if the stripped speaker wires are clamped.

Left and right sound outputs reversed

- Check the speaker connections and location.

No response from the unit

- Disconnect and reconnect the AC power plug, then turn on the system again.
- As a power-saving feature, the unit switches off automatically 15 minutes after track play reaches the end and no control is operated.

Remote control does not work

- Before you press any function button, first select the correct source with the remote control instead of the main unit.

- Reduce the distance between the remote control and the unit.
- Insert the battery with its polarities (+/- signs) aligned as indicated.
- Replace the battery.
- Aim the remote control directly at the sensor on the front of the unit.

No disc detected

- Insert a disc.
- Check if the disc is inserted upside down.
- Wait until the moisture condensation at the lens has cleared.
- Replace or clean the disc.
- Use a finalized CD or correct format disc.

Poor radio reception

- Increase the distance between the unit and your TV or VCR.
- Fully extend the FM antenna.
- Connect an outdoor FM antenna instead.

Timer does not work

- Set the clock correctly.
- Switch on the timer.

Clock/timer setting erased

- Power has been interrupted or the power plug has been disconnected.
- Reset the clock/timer.

USB device not supported

- The USB device is incompatible with the unit. Try another one.

