

Register your product and get support at
www.philips.com/welcome

AJ7030DB



EN User manual

PHILIPS

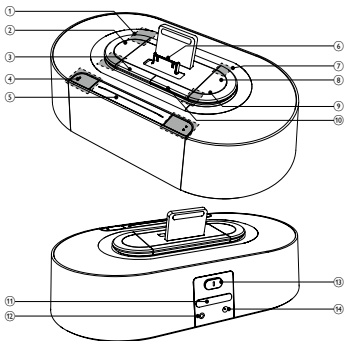
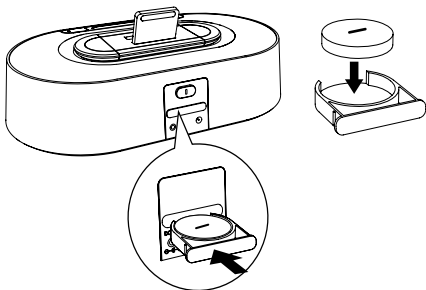
A**B**

C

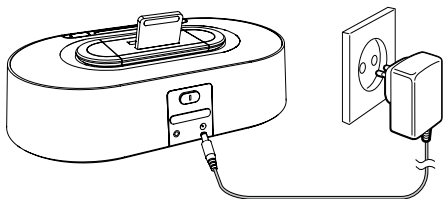

D

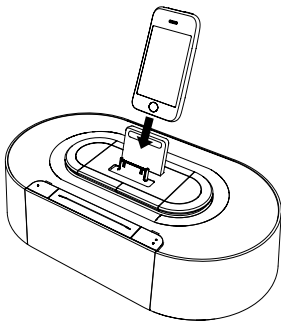

E

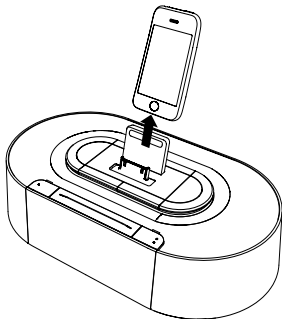

F

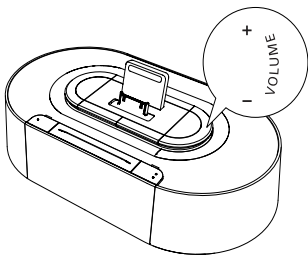

G



1 Important

Safety

Important Safety Instructions

- 1 Read these instructions.
- 2 Keep these instructions.
- 3 Heed all warnings.
- 4 Follow all instructions.
- 5 Do not use this apparatus near water.
- 6 Clean only with dry cloth.
- 7 Do not block any ventilation openings. Install in accordance with the manufacturer's instructions.
- 8 Do not install near any heat sources such as radiators, heat registers, stoves, or other apparatus (including amplifiers) that produce heat.
- 9 Protect the power cord from being walked on or pinched, particularly at plugs, convenience receptacles, and the point where they exit from the apparatus.
- 10 Only use attachments/accessories specified by the manufacturer.
- 11 Use only with the cart, stand, tripod, bracket, or table specified by the manufacturer or sold with the apparatus. When a cart is used, use



caution when moving the cart/apparatus combination to avoid injury from tip-over.

- ⑫ Unplug this apparatus during lightning storms or when unused for long periods of time.
- ⑬ Refer all servicing to qualified service personnel. Servicing is required when the apparatus has been damaged in any way, such as power-supply cord or plug is damaged, liquid has been spilled or objects have fallen into the apparatus, the apparatus has been exposed to rain or moisture, does not operate normally, or has been dropped.
- ⑭ **Battery usage CAUTION** – To prevent battery leakage which may result in bodily injury, property damage, or damage to the unit:
 - Install all batteries correctly, + and - as marked on the unit.
 - Do not mix batteries (old and new or carbon and alkaline, etc.).
 - Remove batteries when the unit is not used for a long time.
- ⑮ Apparatus shall not be exposed to dripping or splashing.
- ⑯ Do not place any sources of danger on the apparatus (e.g. liquid filled objects, lighted candles).
- ⑰ Where the plug of the Direct Plug-in Adapter is used as the disconnect device, the disconnect device shall remain readily operable.



Warning

- Never remove the casing of this apparatus.
- Never lubricate any part of this apparatus.
- Never place this apparatus on other electrical equipment.
- Keep this apparatus away from direct sunlight, naked flames or heat.
- Never look into the laser beam inside this apparatus.
- Ensure that you always have easy access to the power cord, plug or adaptor to disconnect this apparatus from the power.

2 Your clock radio

Congratulations on your purchase, and welcome to Philips! To fully benefit from the support that Philips offers, register your product at www.philips.com/welcome.

Introduction

With this clock radio, you can:

- listen to FM radio;
- enjoy audio from iPod/iPhone or an external device;
- know the time; and
- wake up by buzzer alarm, radio, or audio in iPod/iPhone.

What's in the box

Check and identify the contents of your package:

- Main unit (with a battery)
- AC adapter
- User manual

Overview of the main unit (A)

1 PRESET ▲▼

- Select a preset radio station.
- Adjust hour and minute.

2 TUNING +/-

- Tune to a FM radio station.
- Adjust hour and minute.

3 ①

- Turn on/off the clock radio.
- Switch the clock radio to standby mode.

4 AL1/AL2

- Set alarm.
- View alarm settings.
- Activate/deactivate alarm timer.

5 SNOOZE/BRIGHTNESS

- Snooze alarm.
- Adjust display brightness.

6 iPod/iPhone

- Dock for iPod/iPhone.

7 VOLUME +/-

- Adjust volume.

8 SET

- Store radio stations automatically/manually.
- Set clock.

9 SLEEP

- Set sleep timer.

⑩ SOURCE

- Select source.

⑪ Battery tray

⑫ AUX IN

- Connect an external audio device.

⑬ AL1/2 iPhone · RADIO · BUZZ

- Select alarm source.

⑭ DC 5V

- Power supply socket.

3 Get started



Caution

- Use of controls or adjustments or performance of procedures other than herein may result in hazardous radiation exposure or other unsafe operation.

Always follow the instructions in this chapter in sequence.

Install battery



Caution

- Risk of explosion! Keep batteries away from heat, sunshine or fire. Never discard batteries in fire.
- Danger of explosion if battery is incorrectly replaced. Replace only with the same or equivalent type.
- The battery contains chemical substances, so it should be disposed of properly.
- Keep children away from the battery.
- Perchlorate Material - special handling may apply. See www.dtsc.ca.gov/hazardouswaste/perchlorate.



Note

- You can only use AC power as power supply. The pre-installed lithium CR2032 battery can only back up time and alarm.
- When power is disconnected, the display backlight is off.

For first-time use:

Remove the protective tab to activate the battery.

To replace the battery: **(B)**

Connect power ©



Caution

- Risk of product damage! Ensure that the power voltage corresponds to the voltage printed on the back or underside of the clock radio.
- Risk of electric shock! When you unplug the AC adapter, always pull the plug from the socket. Never pull the cord.

Set clock

- 1** In standby mode, press and hold **SET** for two seconds to activate clock setting mode.
↳ [12H] or [24H] is displayed.
- 2** Press **TUNING +/-** or **▲ / ▼** repeatedly to select 12/24 hour format.
- 3** Press **SET** again to confirm.
↳ The hour digits begin to blink.
- 4** Repeat Steps 2 to 3 to set the hour and minute.



Note

- If clock is not manually set, when iPod/iPhone is connected, the clock radio synchronizes time from the iPod/iPhone automatically.

Turn on

Press ①.

↳ The clock radio switches to the last selected source.

Switch to standby mode

Press ① to switch the clock radio to standby mode.

↳ The clock (if set) appears on the display panel.

4 Play from iPod/iPhone

You can enjoy audio from iPod/iPhone through this clock radio.

Compatible iPod/iPhone

The clock radio supports these iPod and iPhone models:

Made for:

- iPod touch (1st, 2nd, 3rd, and 4th generation)
- iPod classic
- iPod with video
- iPod nano (1st, 2nd, 3rd, 4th, 5th, and 6th generation)
- iPod with color display
- iPod mini
- iPhone 4
- iPhone 3GS
- iPhone 3G
- iPhone

Listen to audio from iPod/iPhone

- 1 Press **SOURCE** repeatedly to select iPod/iPhone mode.
- 2 Place the iPod/iPhone in the dock. (D)
- 3 Start to play audio from the iPod/iPhone.

Remove the iPod/iPhone (E)

Pull the iPod/iPhone out of the dock.

Charge the iPod/iPhone

When the clock radio is connected to power, the docked iPod/iPhone starts charging.

Adjust volume (F)

5 Listen to FM radio

Tune to FM radio stations



Tip

- Position the antenna as far as possible from TV, VCR, or other radiation source.
- For better reception, fully extend and adjust the position of the antenna.

- 1 Press **SOURCE** repeatedly to select FM tuner source.
- 2 Press and hold **TUNING +/-** for 2 seconds.
 - ↳ The clock radio tunes to a station with strong reception automatically.
- 3 Repeat steps 2 to tune to more stations.

To tune to a station manually:

- 1 Press **TUNING +/-** repeatedly until you find optimal reception.

Store FM radio stations automatically

You can store a maximum of 20 FM radio stations.

In tuner mode, press a hold **SET** for two seconds.

- ↳ The clock radio stores all the available FM radio stations and broadcasts the first available station automatically.

Store FM radio stations manually

- 1 Tune to an FM radio station.
- 2 Press **SET**.
 - ↳ The preset number begins to blink.
- 3 Press **PRESET ▲ / ▼** repeatedly to select a number.
- 4 Press **SET** again to confirm.
- 5 Repeat steps 1 to 4 to store other stations.



Note

- To remove a pre-stored station, store another station in its place.

Select a preset radio station

In tuner mode, press **PRESET** ▲ / ▼ to select a preset number.

6 Other features

Set alarm timer

Set alarm

In standby mode, you can set two alarms to ring at different time.



Note

- Make sure that you have set the clock correctly.

- 1** Press and hold **AL1/AL2** for two seconds to activate alarm setting mode.
 - ↳ The hour digits and alarm icon begin to blink.
- 2** Press **TUNING +/-** or ▲ / ▼ to set the hour.
- 3** Press **AL1/AL2** to confirm.
 - ↳ The minute digits begin to blink.
- 4** Repeat steps 2 to 3 to set the minute and alarm volume. ©

Select alarm source

Adjust **AL1/2** **iPhone** **RADIO** **BUZZ** control to select alarm source for both alarms.





Note

- When alarm time comes, the selected radio, buzzer, or iPod/iPhone turns on.
- You can only select the same alarm source for Alarm 1/ Alarm2.
- If iPhone is selected as alarm source, while no iPod/iPhone is connected, the clock radio switches to buzzer source instead.

Activate/deactivate alarm timer

1 Press **AL1/AL2** to view alarm settings.

2 Press **AL1/AL2** again to activate or deactivate the alarm timer.

↳  or  appears if alarm timer is on and disappears if it is off.

- To stop the ringing alarm, press the corresponding **AL1/AL2**.
- The alarm repeats ringing for the next day.

Snooze alarm

When alarm sounds, press **SNOOZE**.

↳ The alarm snoozes and repeats ringing nine minutes later.

Set sleep timer

This clock radio can switch to standby mode automatically after a preset period.

Press **SLEEP** repeatedly to select the sleep timer period (in minutes).

↳ When the sleep timer is activated, **zZ** appears.

To deactivate the sleep timer, press **SLEEP** repeatedly until **[OFF]** (off) appears.

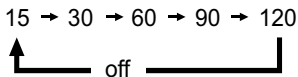

Play audio from an external device

You can listen to audio from an external device through this clock radio.

- 1 Connect the audio cable to:
 - the **AUX IN** socket.
 - the **AUDIO OUT** sockets of an external device.
- 2 Press **SOURCE** repeatedly to select AUX source.
 - ↳  is displayed.
- 3 Start to play the external device (see the user manual of this device).

Adjust display brightness

Press **BRIGHTNESS** repeatedly to select different brightness levels.

7 Product information



Note

- Product information is subject to change without prior notice.

Specifications

Amplifier

Rated Output Power	2 X 3 W RMS
--------------------	-------------

Tuner

Tuning Range	FM: 87.5 - 108 MHz
--------------	--------------------

Sensitivity - Mono, 26dB S/N Ratio	FM: <22 dBf
---------------------------------------	-------------

Search Selectivity	FM: <28 dBf
--------------------	-------------

Total Harmonic Distortion	FM: <2%
---------------------------	---------

Signal to Noise Ratio	FM: >55 dB
-----------------------	------------

General information

AC Power	Model: ASSA1I-050200; Output: 5 V; 2 A
----------	---

Operation Power Consumption	17 W
-----------------------------	------

Dimensions

- Main Unit (W x H x D)	198 x 71 x 111 mm
-------------------------	-------------------

Weight

- With Packing	0.9 kg
- Main Unit	0.5 kg

8 Troubleshooting



Warning

- Never remove the casing of this apparatus.

To keep the warranty valid, never try to repair the system yourself. If you encounter problems when using this apparatus, check the following points before requesting service. If the problem remains unsolved, go to the Philips web site (www.philips.com/welcome). When you contact Philips, ensure that the apparatus is nearby and the model number and serial number are available.

No power

- Ensure that the AC power plug of the clock radio is connected properly.
- Ensure that there is power at the AC outlet.

No response from the clock radio

- Disconnect and reconnect the AC power plug, then turn on the clock radio again.

Poor radio reception

- Increase the distance between the unit and your TV or VCR.
- Fully extend the FM antenna.

Alarm does not work

- Set the clock/alarm correctly.

Clock/alarm setting erased

- Power has been interrupted or the power plug has been disconnected.
- Reset the clock/alarm.

9 Notice

Any changes or modifications made to this device that are not expressly approved by Philips Consumer Lifestyle may void the user's authority to operate the equipment.

Your product is designed and manufactured with high quality materials and components, which can be recycled and reused.



Disposal of your old product and batteries

Your product is designed and manufactured with high quality materials and components, which can be recycled and reused.

Never dispose of your product with other household waste. Please inform yourself about the local rules on the separate collection of electrical and electronic products and batteries. The correct disposal of these products helps prevent potentially negative consequences on the environment and human health.

Please visit www.recycle.philips.com for additional information on a recycling center in your area.

Environmental information

All unnecessary packaging has been omitted. We have tried to make the packaging easy to separate into three materials: cardboard (box), polystyrene foam (buffer) and polyethylene (bags, protective foam sheet.)

Your system consists of materials which can be recycled and reused if disassembled by a specialized company. Please observe the local regulations regarding the disposal of packaging materials, exhausted batteries and old equipment.

“Made for iPod” and “Made for iPhone” mean that an electronic accessory has been designed to connect specifically to iPod or iPhone respectively, and has been certified by the developer to meet Apple performance standards. Apple is not responsible for the operation of this device or its compliance with safety and regulatory standards. Please note that the use of this accessory with iPod or iPhone may affect wireless performance.



iPod and iPhone are trademarks of Apple Inc., registered in the U.S. and other countries.



Note

- The type plate is located on the bottom of the apparatus.

2011 © Koninklijke Philips Electronics N.V. All rights reserved. Specifications are subject to change without notice. Trademarks are the property of Koninklijke Philips Electronics N.V. or their respective owners. Philips reserves the right to change products at any time without being obliged to adjust earlier supplies accordingly.



© 2011 Koninklijke Philips Electronics N.V.

All rights reserved.

AJ7030DB_93_UM_V1.0

